

Large Size Vacuum Module:

Series ZR

Ejector System/Vacuum Pump System



- Large suction flow rate, suitable when used with large size pads or multiple pads.
- Nozzle dia. $\varnothing 1.0$, $\varnothing 1.3$, $\varnothing 1.5$, $\varnothing 1.8$, $\varnothing 2.0$
- Vacuum module suitable for handling workpieces of 0.5 to 5 kg.

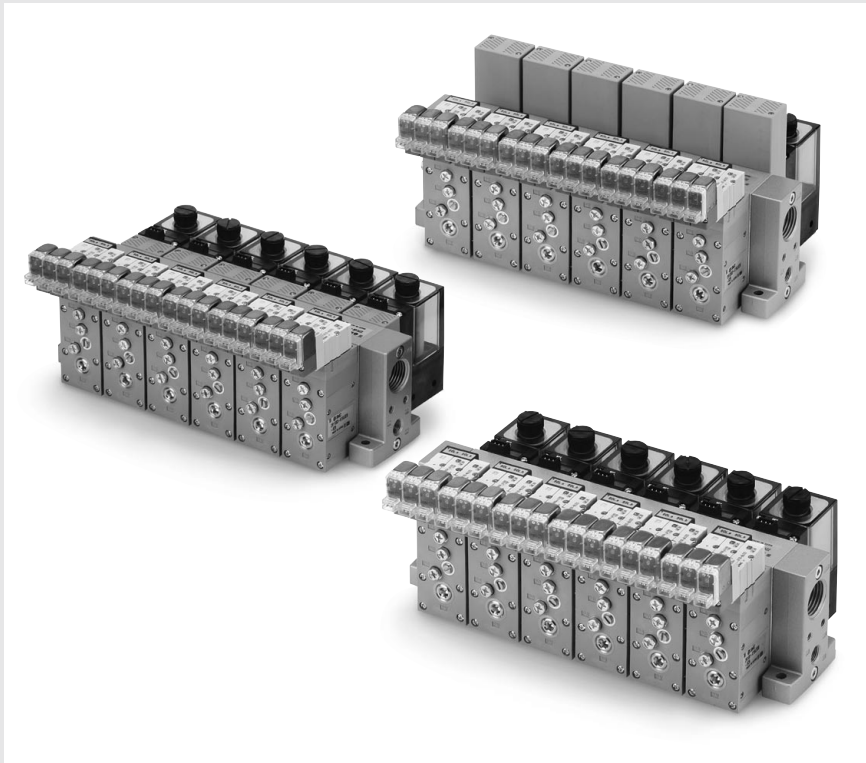

ZK2

ZQ

ZR

ZA

ZX

ZM

ZMA

ZL

ZH

ZU

ZYY

ZYX

Series ZR

Vacuum module suitable for handling workpieces of 0.5 to 5 kg.

- **Modular design/Customized application function through selection of modular components.**
- **Modules for use with external vacuum supply (from pump or mainline) or as an air driven ejector system.**
- **Safe — Vacuum self-holding function by means of double solenoid valves.**
- **Compact, Lightweight**
- **Manifolding possible**

Vacuum ejector type complete unit

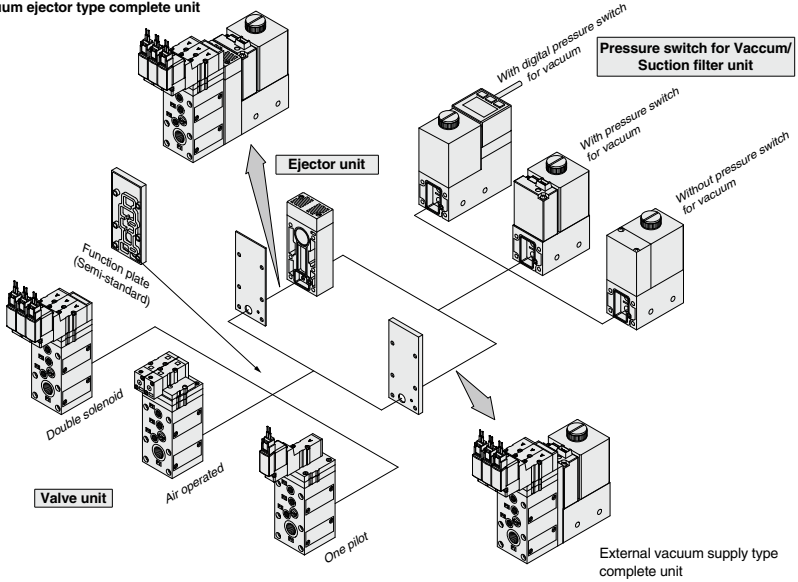

Application Example

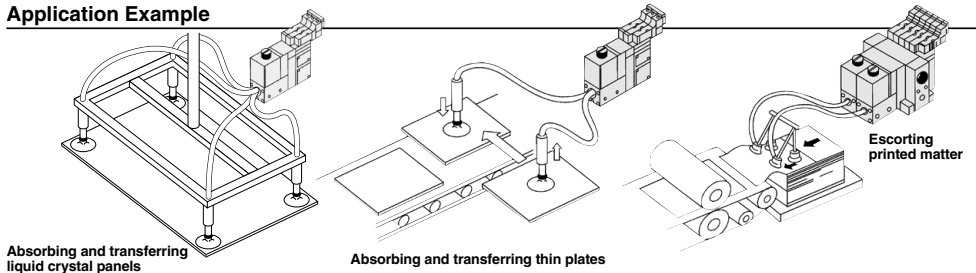

Absorbing and transferring copper plates, Automatic labeling machine, Absorbing and transferring veneers, Automatic screw fastening machine

Modular Components Introduction

System	
Component equipment	Characteristics

Ejector unit ZR1-W



Nozzle dia. (mm)	Type S
Maximum suction flow rate (L/min. [ANR])	Type L
Air consumption (L/min [ANR])	
Maximum vacuum pressure	
Exhaust release (Ejector exhaust)	

Valve unit ZR1-V



Component equipment
Function
Operation
Power supply voltage

Pressure switch for vacuum ZSE2-0R-15/55 ZSE30A-00-□-□□□



Rated pressure range/Set pressure range
Hysteresis
Operating voltage

Suction filter unit ZR1-F



Operating pressure range
Filtration degree
Material

Function plate ZR1-RV

Symbol	RV1
	RV2
	RV3

Ejector System				
P. 974 to 1003				

1.0	1.3	1.5	1.8	2.0
22	38	54	62	84
42	52	74	88	105
46	78	95	150	185
S: -84 kPa		L: -53 kPa		
Built-in silencer, Manifold exhaust Individual exhaust port				

Vacuum Pump System
P. 1004 to 1019

—

Supply valve (Pilot type)/Release valve (Pilot type)
N.C./N.O.
Solenoid valve (Double, Single)/Air operated valve
3, 5, 6, 12, 24 VDC, 100, 110 VAC (50/60Hz)

0 to -101 kPa
3% or less/variable
12 to 24 VDC (Ripple ±10% or less)

-0.1 to 0.5MPa
30 μ m
PVF

Air pressure supply (PV) port ↔ Pilot pressure supply (PS) port ↔ Release pressure supply (PD) port
Air pressure supply (PV) port ↔ Pilot pressure supply (PS) port / Release pressure supply (PD) port
Air pressure supply (PV) port / Pilot pressure supply (PS) port ↔ Release pressure supply (PD) port

Common specifications	Unit	Air supply port
		Vacuum pad connection port
	Manifold	Air supply port
		Pilot valve connection port
		Release valve connection port
		Common exhaust port
		External vacuum supply port

Rc 1/8	
Rc 1/8	
Rc 1/8	
M5	
M5	
Rc 1/2	
—	Rc 1/8

Refer to pages 980 to 990 for further specifications of each unit.

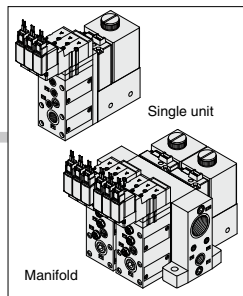
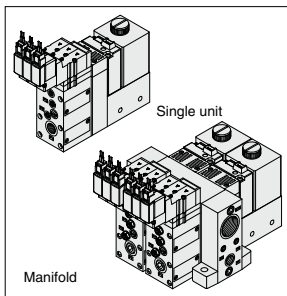

ZK2

ZQ

ZR

ZA

ZX

ZM

ZMA

ZL

ZH

ZU

ZYY

ZYZ

Large Size Vacuum Module: Ejector System

Series ZR



[Option]
Note) CE-compliant:
For DC only.



How to Order

Note for model selection

Take function plates into consideration. (Refer to page 97.7.)

Components

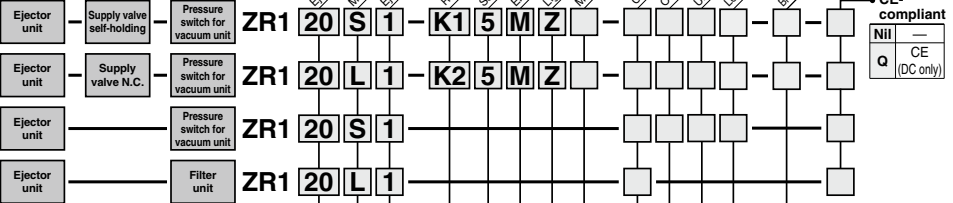

Ejector module nozzle diameter

10	1.0	18	1.8
13	1.3	20	2.0
15	1.5		

Maximum vacuum pressure

S	-84 kPa
L	-53 kPa

Ejector exhaust

Symbol	Type	Valve	Manifold
1	Built-in silencer	●	●
2 (Note 1)	Port exhaust	●	●
3 (Note 2)	Common exhaust	—	●

Combination of supply valve and release valve
Refer to "Table (1)" on page 97.5 for details.

Note 1) When port exhaust is applied to the manifold, pilot exhaust is done by common exhaust. Thus, the exhaust port on the manifold base should be open while operating.

Note 2) When the product is used for the manifold specification and common exhaust, the exhaust air of the operating ejector and released if there are an operating and non-operating ejector. Select either the built-in silencer or port exhaust for the ejector exhaust method.

Solenoid valve rated voltage

Nil (Note)	Air operated	CE-compliant
5	24 VDC	●
6	12 VDC	●
V	6 VDC	●
S	5 VDC	●
R	3 VDC	●
D1 (Note)	100 VAC (50/60 Hz)	—
D2 (Note)	110 VAC (50/60 Hz)	—

Note) Air operated, 100 VAC, and 110 VAC type are not CE-compliant.

Electrical entry

Nil	Air operated
L	L plug
LN	connector
LO	type
M	M plug
MO	connector
MM	type
G	Grommet
H	type

* Refer to "Table (2)" on page 97.5 for part no. of lead wire with connector.

Light/Surge voltage suppressor

Nil	None
Z	With light/surge voltage suppressor
S	With surge voltage suppressor

* S is not available for AC.
DC voltage (with surge voltage suppressor)
If the polarity is incorrect at DC (surge voltage suppressor), diode or switching element may be damaged.

Manual override

Nil	Non-locking push type
B	Slotted locking type

Combination of switch/filter

Nil	None
D	Digital pressure switch for vacuum (ZSE30A) + Filter
E	Pressure switch for vacuum (ZSE2) + Filter
F	Filter

Release flow rate adjusting needle/Bracket A, B

	Lock nut	Bracket A or B
Nil	×	●
L	●	●
M	×	×
N	×	×

● : Attached (Bracket A or B is shipped together.)
× : None

Lead wire specifications

Digital pressure switch for vacuum (ZSE30A) specifications (D)

Nil	Without lead wire
L	Lead wire with connector (Length 2 m)

Refer to "Table (4)" on page 97.5 for part no. of lead wire with connector.

Pressure switch for vacuum (ZSE2) specifications (E)

Nil	Grommet/Lead wire (Length 0.6 m)
L	Grommet/Lead wire (Length 3 m)
C	Lead wire with connector (Length 0.6 m)
CL	Lead wire with connector (Length 3 m)
CN	Without lead wire with connector

Refer to "Table (3)" on page 97.5 for part no. of lead wire with connector.

Filter specifications (F)

Nil	No setting
-----	------------

Unit specifications

Digital pressure switch for vacuum (ZSE30A) specifications (D)

Nil	With unit switching function
M	SI unit only
P	With unit switching function (Initial value psi)

Note 1) This is no longer sold for use in Japan due to the Weight and Measure Act (implemented October, 1999).
Note 2) Fixed unit: kPa

Pressure switch for vacuum (ZSE2) specifications (E)

Nil	No setting
-----	------------

Filter specifications (F)

Nil	No setting
-----	------------

Output specifications

Digital pressure switch for vacuum (ZSE30A) specifications (D)

N	NPN open collector 1 output
P	PNP open collector 1 output
A	NPN open collector 2 outputs
B	PNP open collector 2 outputs
C	NPN open collector 1 output + Analog voltage output
D	NPN open collector 1 output + Analog current output
E	PNP open collector 1 output + Analog voltage output
F	PNP open collector 1 output + Analog current output

Pressure switch for vacuum (ZSE2) specifications (E)

Nil	NPN open collector 1 output
55	PNP open collector 1 output

Filter specifications (F)

Nil	No setting
-----	------------

ZK2
ZQ
ZR
ZA
ZX
ZM
ZMA
ZL
ZH
ZU
ZYY
ZYX

Table (1) Combination of Supply Valve and Release Valve

Valve unit function			Valve unit components		Symbol	Supply valve				Release valve			
Operation stop	Vacuum adsorption	Vacuum release	Supply valve	Release valve		Solenoid valve			Air operated	Solenoid valve			Air operated
						Double SOL. (SYJ3233-X126)	Double SOL. (SYJ3233-X127)	N.C (SYJ3133)	(SYJA3130)	Double SOL. (SYJ3233-X126)	Double SOL. (SYJ3233-X127)	N.C (SYJ3133)	(SYJA3130)
☉	☉	○	Double SOL. (SYJ3233-X126)	N.C. (SYJ3133)	K1	●	—	—	—	—	—	●	—
○	○	○	N.C. (SYJ3133)	N.C. (SYJ3133)	K2	—	—	●	—	—	—	●	—
○	○	○	Air operated (SYJA3130)	Air operated (SYJA3130)	K3	—	—	—	●	—	—	—	●
×	○	○	N.C. (SYJ3133)		C1	—	—	●	—	—	—	(Common with supply valve)	—
×	○	○	Air operated (SYJA3130)		C2	—	—	—	●	—	—	—	(Common with supply valve)
×	○	○	N.O. (SYJ3133)		C3	—	—	●	—	—	—	(Common with supply valve)	—
×	☉	☉	Double SOL. (SYJ3233-X127)		C4	—	●	—	—	—	(Common with supply valve)	—	—
<small>☉: Possible (without self-holding function) ○: Possible with limitations (without self-holding function) ×: Not possible</small>					NII	Without valve module							

Table (2) How to Order Valve Plug Connector Assembly

DC	SY100 - 30 - 4A	□
For 100 VAC	SY100 - 30 - 1A	□
For other voltages of AC	SY100 - 30 - 3A	□

Lead wire length	
NII	300 mm (Standard)
6	600 mm
10	1000 mm
15	1500 mm
20	2000 mm
25	2500 mm
30	3000 mm
50	5000 mm

How to order

When requiring a vacuum unit equipped with valves with lead wires of 600 mm or more, specify the vacuum module valves without the standard connectors and order the required connector ass'ys separately.

Example) ZR120S1-K15M□Z-EC(-Q) 1 pc.
*SY100-30-4A-6 3 pcs.

Table (3) Pressure Switch for Vacuum/Lead Wire with Connector

ZS - 10 - 5A	□
---------------------	---

Lead wire length

NII	0.6 m
30	3 m
50	5 m

How to order

When requiring a vacuum switch with a lead wire of 5 m, indicate the part numbers of the vacuum unit switch without a lead wire connector and the 5 m lead wire connector separately.

Example) ZR1□□□-□□□□□□-□CN(-Q) 1 pc.
*ZS-10-5A-50 1 pc.

Table (4) Digital Pressure Switch for Vacuum/Lead Wire with Connector

ZS - 38 -	3	L
------------------	----------	----------

Lead wire core

3	3 cores, 1 output, 2 m (Output specifications: N, P)
4	4 cores, 2 outputs, 2 m (Output specifications: A, B, C, D, E, F)

Ejector System/Combination of Supply Valve and Release Valve

Combination Symbol: K1

Feature: Double solenoid supply valve allows for self-holding.

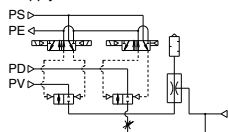

How to Operate

Operation	Pilot valve operation		Note
	Supply valve for supply	Release valve for release	
1. Adsorption	ON	OFF	When power supply is cut off while the supply valve is ON, the operational state is held.
2. Vacuum release	OFF	ON	
3. Operation stop	OFF	OFF	

Combination Symbol: K2

Feature: Single solenoid valve is provided for supply valve.

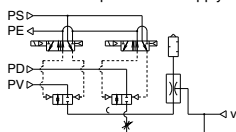

How to Operate

Operation	Pilot valve operation		Note
	Supply valve for supply	Release valve for release	
1. Adsorption	ON	OFF	When power supply is stopped, all operations will be stopped.
2. Vacuum release	OFF	ON	
3. Operation stop	OFF	OFF	

Combination Symbol: K3

Feature: Operation can be controlled by an external pilot valve.

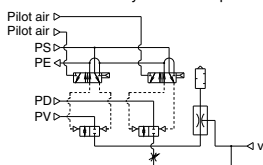

How to Operate

Operation	Pilot valve operation		Note
	Supply valve Air operated a	Release valve Air operated b	
1. Adsorption	ON	OFF	The product is used under the environment in which solenoid valves cannot be used or when the centralized control is applied using external pilot air.
2. Vacuum release	OFF	ON	
3. Operation stop	OFF	OFF	

⚠ Caution

When pipe connection is made to one port connection (PV) port only, use a function plate (ZR1-RV1). Refer to page 977 for further information.

Combination Symbol: C1

Feature: Adsorption of workpieces (when energized) and release of vacuum (when de-energized) are switched by single solenoid valve.

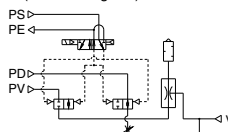

How to Operate

Operation	Pilot valve operation		Note
	Supply valve/Release valve	Pilot valve for supply/release	
1. Adsorption	ON	ON	Be careful for blowing off of workpieces or displacement of adsorption position in case of small and/or lightweight workpieces.
2. Vacuum release	OFF	OFF	

Combination Symbol: C2

Feature: Adsorption of workpieces and release of vacuum are switched by external pilot valve.

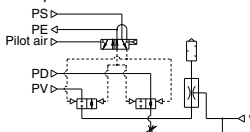

How to Operate

Operation	Pilot valve operation		Note
	Supply valve/Release valve Air operated a	Pilot valve for release	
1. Adsorption	ON	OFF	Be careful for blowing off of workpieces or displacement of adsorption position in case of small and/or lightweight workpieces.
2. Vacuum release	OFF	ON	

Combination Symbol: C3

Feature: Adsorption of workpieces (when de-energized) and release of vacuum (when energized) are switched by single solenoid valve.

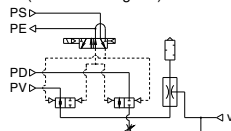

How to Operate

Operation	Pilot valve operation		Note
	Supply valve/Release valve	Pilot valve for supply/release	
1. Adsorption	OFF	OFF	Be careful for blowing off of workpieces or displacement of adsorption position in case of small and/or lightweight workpieces.
2. Vacuum release	ON	ON	

Combination Symbol: C4

Feature: Adsorption of workpieces and release of vacuum are switched by double solenoid valve.

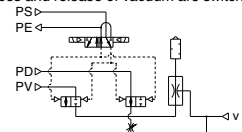

How to Operate

Operation	Pilot valve operation		Note
	Supply valve/Release valve	Pilot valve for release	
1. Adsorption	ON	OFF	When power supply is stopped, supply valve/ release valve will hold the operation.
2. Vacuum release	OFF	ON	

Function Plate/ZR1-RV□

A function plate is used when each connecting port for the valve unit is common. If a function plate is not used (standard), make individual pipe connections to PV, PS, and PD ports respectively.

Without Function Plate (Standard)

Applicable system: Ejector system
External vacuum supply system

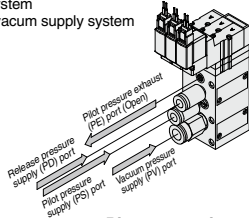

Pipe connection

Circuit diagram

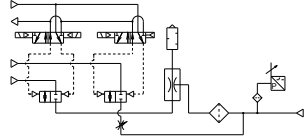

With Function Plate/Applicable to Ejector System Only

When ZR1/RV1 (PV PS PD) is Selected

Since PV, PS and PD ports are made common via the function plate, pipe only to the PV port.

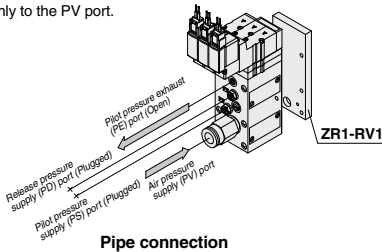

Pipe connection

Circuit diagram

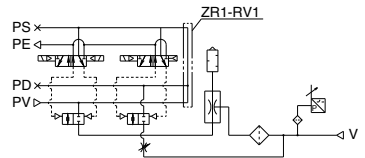

When ZR1/RV2 (PV PS/PD) is Selected

Supply air for generating vacuum and releasing vacuum respectively.

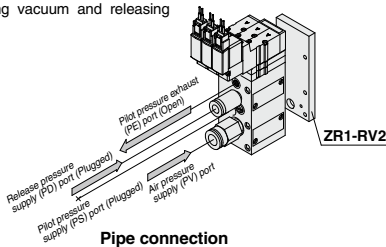

Pipe connection

Circuit diagram

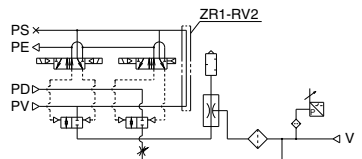

How to Order Function Plate Unit (For Ejector System)

ZR1 - RV 1

Piping specifications

Symbol	Indication	PV port	PS port	PD port
1	PV PS PD	Common		
2	PV PS/PD	Common	Individual	

How to order

Indicate the model numbers of the vacuum module and the function plate.

Example) ZR120S1-K15MZ-EC..... 1 pc.
* ZR1-RV1 1 pc.

Caution

Length of assembling mounting threads varies when adding function plate. Order from the mounting thread parts list for unit combination on page 1018.
Order a plug (ZX1-MP1) separately in order to plug the PD and PS ports that are no longer used due to the addition of function plate.

- ZK2
- ZQ
- ZR**
- ZA
- ZX
- ZM
- ZMA
- ZL
- ZH
- ZU
- ZYY
- ZYX

Construction

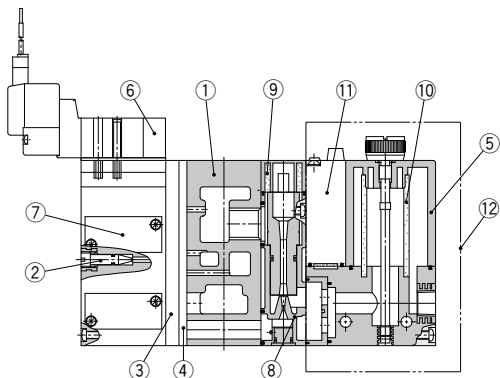

Component Parts

No.	Description	Material	Part Model
1	Manifold base	Aluminum alloy	
2	Release flow rate adjusting needle	Stainless steel	ZR-NA ^{Note 2)}
3	Function plate	PBT	Refer to page 998.
4	Individual spacer	PBT	Refer to page 998.
5 ^{Note 1)}	Filter case	Polycarbonate	Refer to page 989.
6	Pilot valve assembly	—	Refer to "Table (5)" on page 979.
7	Valve body assembly	—	Refer to "Table (1)" on page 979.

No.	Description	Material	Part Model
8	Ejector assembly	—	Refer to "Table (2)" on page 979.
9	Silencer	PVF	Refer to "Table (3)" on page 979.
10	Filter element	PVF	ZR1-FZ(30 μm)
11	Pressure switch for vacuum	—	ZSE2-OR- $\frac{15}{35}$ -□
12	Filter switch unit for replacement	—	ZR1-F□□□□-D

Note 1) Precautions on handling the filter case

1. The case is made of polycarbonate. Therefore, do not contact it or expose it to the following chemicals: paint thinner, carbon tetrachloride, chloroform, acetic ester, aniline, cyclohexane, trichloroethylene, sulfuric acid, lactic acid, water soluble cutting oil (alkalinoic), etc.

2. Do not expose it to direct sunlight.

Note 2) Turning the release flow rate adjusting needle 2 full turns from the fully closed position renders the needle valve fully open. Do not turn more than two times since turning excessively may cause the needle fall off.

In order to prevent the needle from loosening and falling out, the release flow rate adjusting (ZR1-ND-L) lock nut is also available.

How to Order Solenoid Valves/Air Operated Valves

Air operated

SYJA3130

Solenoid valve

ZR1-SYJ3233

SYJ3133

rated voltage

5	DC24V
6	DC12V
V	DC6V
S	DC5V
R	DC3V
1	AC100V(50/60Hz)
3	AC110V(50/60Hz)

Electrical entry

L	L plug connector type	Lead wire: 0.3 m
LN		Without lead wires
LO		Without connector
M	M plug connector type	Lead wire: 0.3 m
MN		Without lead wires
MO		Without connector
G	Grommet type	Lead wire: 0.3 m(Apples only to DC)
H		Lead wire: 0.6 m(Apples only to DC)

X126
X127

CE-compliant

Nil	Standard
Q	CE-compliant (DC only)

Manual override

Nil	Non-locking push type
D	Slotted locking type

Light/Surge voltage suppressor

Nil	None
Z	With light and surge voltage suppressor
S	With surge voltage suppressor (DC only)

Note) Mounting screw and pilot valve gasket are included.

Construction

(1) How to Order Valve Body Assembly

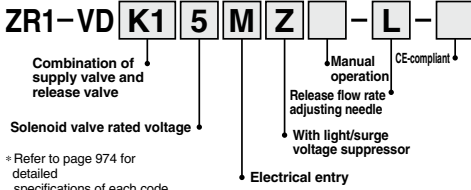

(2) How to Order Ejector Assembly

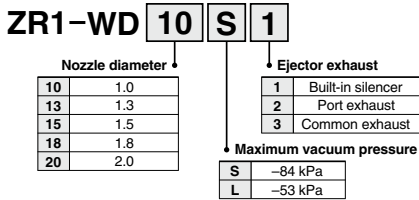

(3) How to Order Silencer

Element

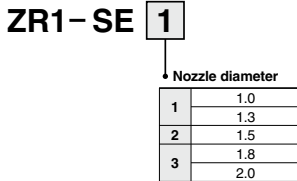

Silencer assembly (Case, Element, Mounting screw)

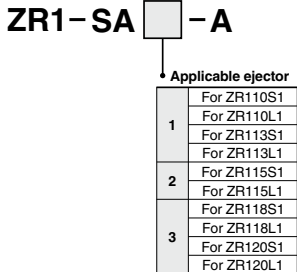

(3) How to Order Silencer

Silencer case assembly for port exhaust (Case, Mounting screw)

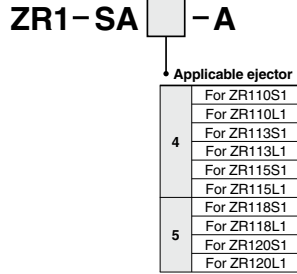

Silencer case assembly for centralized exhaust (Case, Element, Mounting screw)

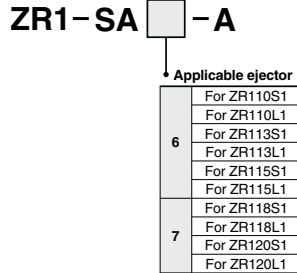

(4) Pressure Switch for Vacuum + Suction Filter Unit

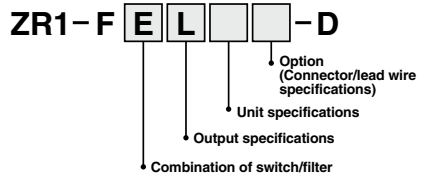

* Refer to page 989 for detailed specifications of each code.

(5) How to Order Pilot Valves

Combination Symbol	Components		Model
	Supply valve	Release valve	
K1	Double solenoid valve N.C. (SYJ3233)	Single solenoid valve N.C. (SYJ3133)	Refer to "How to Order" below. Supply: ZR1-SYJ3233-□□□□-X126 Release: SYJ3133-□□□□
C4	Double solenoid valve N.O. (SYJ3233)	Double solenoid valve N.O. (SYJ3233)	Refer to "How to Order" below. ZR1-SYJ3233-□□□□-X127
K3	Air operated N.C. (SYJA3130)	Air operated N.O. (SYJA3130)	SYJA3130

ZK2
ZQ
ZR
ZA
ZX
ZM
ZMA
ZL
ZH
ZU
ZYY
ZYX

Valve Unit : ZR1-V□□□□□-□-□

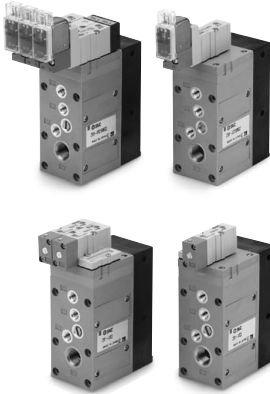

Specifications

Valve unit part no.	ZR1-V□□□□□-□-□	
Components	Supply valve	Release valve
Operating method	Pilot operated	Pilot operated
Combination of supply valve and release valve	Refer to the combination of supply valve and release valve below.	
PV port supply pressure	-0.1 to 0.6 MPa	
PD port supply pressure	0.05 to 0.6 MPa	
PS port supply pressure	0.25 to 0.6 MPa	
Main valve effective area (mm²)	8.2	0.96
Main valve effective area (Cv)	0.45	0.053
Maximum operating frequency	5 Hz	
Operating temperature range	5 to 50°C	
Standard accessory	Bracket B (ZR1-OB)	

Solenoid Valve/Specifications

Solenoid	SYJ3133-□□□□, SYJ3233-□□□□-X126, SYJ3233-□□□□-X127
Rated voltage	24, 12, 6, 5, 3 VDC, 100, 110 VAC (50/60Hz)
Electrical entry	L/M plug connector, Grommet
Light/Surge voltage suppressor	Available, Not available (at grommet)
Manual operation	Non-locking push type, Locking slotted type

* Applicable to plug connector; connector assembly with rectifier is attached.

Combination of Supply Valve and Release Valve

Combination symbol	Vacuum switch valve	Release valve	Weight (kg)
K1	Double SOL. (SYJ3233-X126)	N.C. (SYJ3133)	0.34
K2	N.C. (SYJ3133)	N.C. (SYJ3133)	0.27
K3	Air operated (SYJA3130)	Air operated (SYJA3130)	0.194
C1	N.C. (SYJ3133)		0.22
C2	Air operated (SYJA3130)		0.174
C3	N.C. (SYJ3133)		0.21
C4	Double SOL. (SYJ3233-X127)		0.27

* Weight includes Bracket B. (Solenoid valve: 24 VDC, M plug connector type)

How to Order

Refer to page 974 for further part no. information.

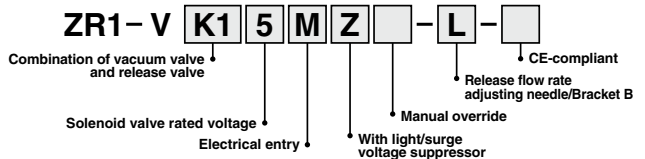

Ejector Unit/Series ZR1

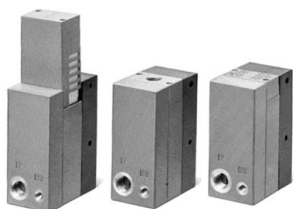

Model/Max. Vacuum Pressure -84 kPa (S: Standard type)

Model	Nozzle dia. (mm)	Maximum suction flow rate (L/min (ANR))	Air consumption (L/min (ANR))	Weight (With bracket) (kg)
ZR1-W10S□	1.0	25	53	0.132
ZR1-W13S□	1.3	42	86	0.134
ZR1-W15S□	1.5	63	102	0.136
ZR1-W18S□	1.8	74	155	0.154
ZR1-W20S□	2.0	95	194	0.156

Model/Max. Vacuum Pressure -53 kPa (L: Large flow type)

Model	Nozzle dia. (mm)	Maximum suction flow rate (L/min (ANR))	Air consumption (L/min (ANR))	Weight (With bracket) (kg)
ZR1-W10L□	1.0	44	53	0.133
ZR1-W13L□	1.3	55	86	0.133
ZR1-W15L□	1.5	88	102	0.135
ZR1-W18L□	1.8	105	155	0.155
ZR1-W20L□	2.0	132	194	0.154

Common Specifications

Supply pressure range	0.2 to 0.55 MPa
Standard supply pressure	0.45 MPa
Operating temperature range	5 to 50°C
Model (Ejector exhaust method)*	Code 1: Built-in silencer — For unit and manifold Code 2: Individual exhaust — For unit and manifold
Standard accessory	Bracket (ZR1-OBB)

* How to Order: Code 1 and 2 are the suffixes in the ordering number to indicate the exhaust method.
Note) Operation outside of the specified supply pressure and operating temperature range may cause a serious accident or damage.

Symbol

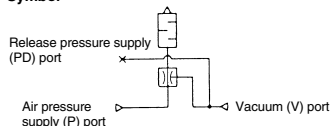

How to Order

ZR1-W 20 S 1 - □

Nozzle diameter

10	1.0
13	1.3
15	1.5
18	1.8
20	2.0

Bracket B

NII	With Bracket B
N	Without Bracket B

Ejector exhaust

1	Built-in silencer
2	Individual exhaust*

Maximum vacuum pressure

S	- 84 kPa
L	- 53 kPa

* Port size:
RC 1/4 (Nozzle dia. 1.0 to 1.5)
RC 3/8 (Nozzle dia. 1.8, 2.0)

ZK2

ZQ

ZR

ZA

ZX

ZM

ZMA

ZL

ZH

ZU

ZYY

ZYX

Characteristics (Representative value)

Ejector Unit/Standard Type (S): Max. Vacuum Pressure -84 kPa

At 0.45 MPa

ZR1-W10S1 Exhaust characteristics

Flow characteristics

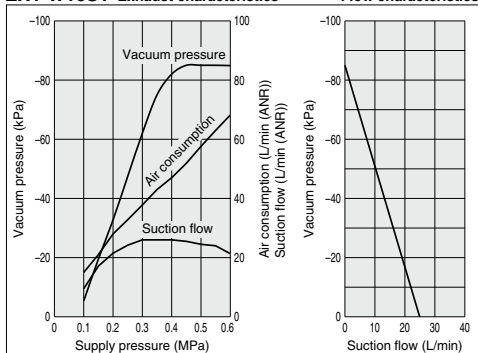

ZR1-W18S1 Exhaust characteristics

Flow characteristics

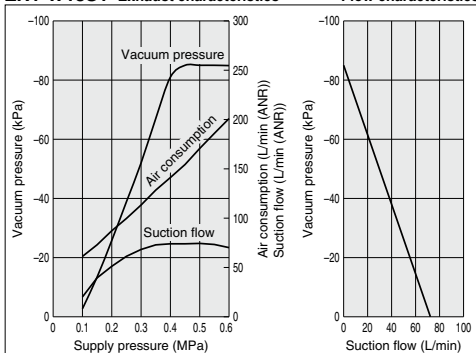

ZR1-W13S1 Exhaust characteristics

Flow characteristics

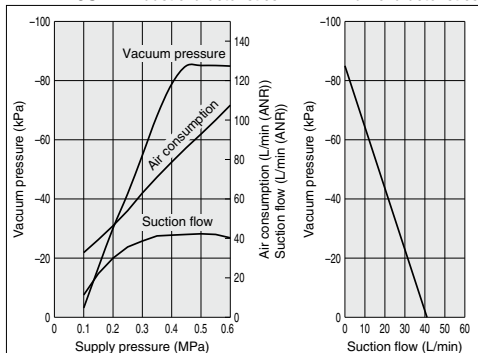

ZR1-W20S1 Exhaust characteristics

Flow characteristics

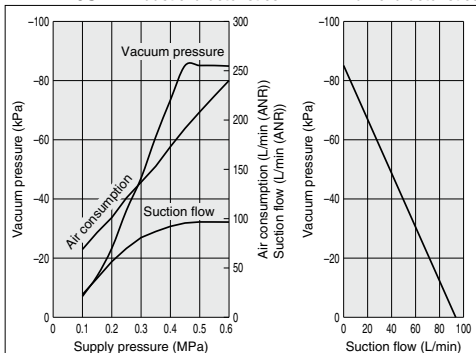

ZR1-W15S1 Exhaust characteristics

Flow characteristics

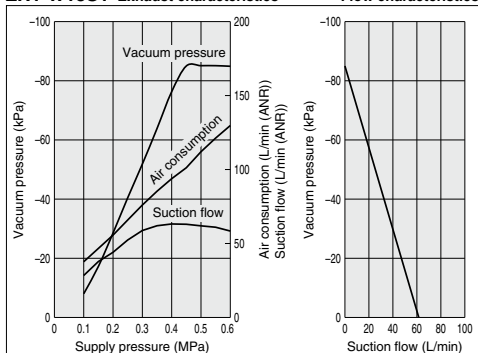

Ejector Unit/Large Flow Type (L): Max. Vacuum Pressure –53 kPa

At 0.45 MPa

ZR1-W10L1 Exhaust characteristics

Flow characteristics

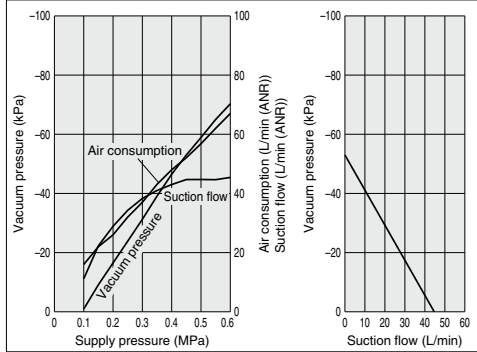

ZR1-W18L1 Exhaust characteristics

Flow characteristics

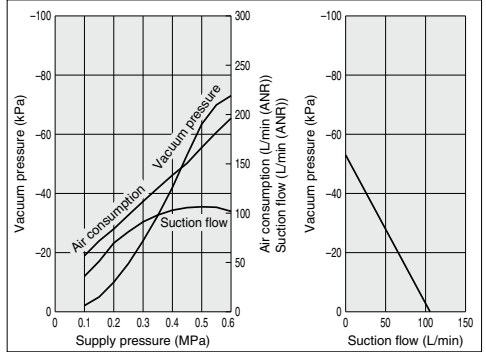

ZR1-W13L1 Exhaust characteristics

Flow characteristics

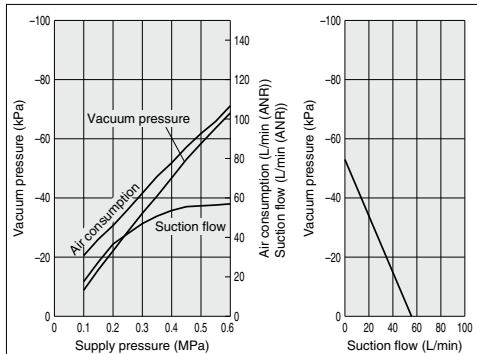

ZR1-W20L1 Exhaust characteristics

Flow characteristics

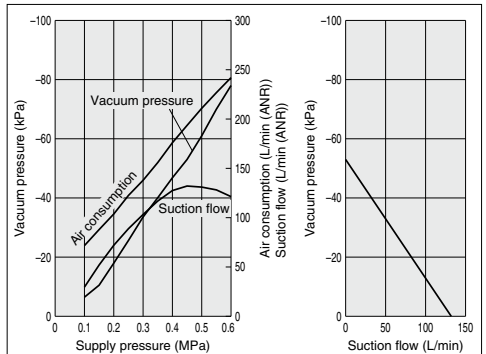

ZR1-W15L1 Exhaust characteristics

Flow characteristics

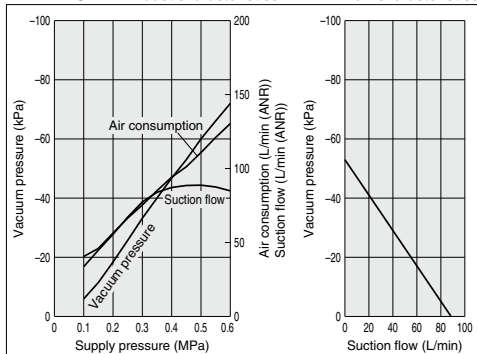

How to Read Flow Characteristics Graph

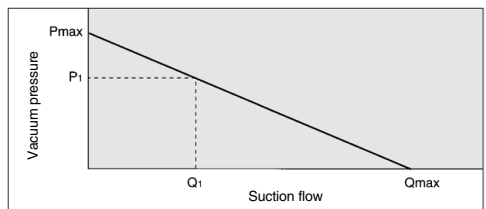

Flow characteristics are expressed in ejector vacuum pressure and suction flow. If suction flow rate changes, the vacuum pressure will also be changed. Normally this relationship is expressed in ejector standard use. In graph, Pmax is max. vacuum pressure and Qmax is maximum suction flow. The values are specified according to catalog use. Changes in vacuum pressure are expressed in the below order.

1. When ejector suction port is covered and made airtight, suction flow becomes 0 and vacuum pressure is at maximum value (Pmax).
2. When suction port is opened gradually, air can flow through, (air leakage), suction flow increases, but vacuum pressure decreases. (condition P1 and Q1)
3. When suction port is opened further, suction flow moves to maximum value (Qmax), but vacuum pressure is near 0 (atmospheric pressure).

Based on the above, when vacuum port (vacuum piping) has no leakage, vacuum pressure becomes maximum, and vacuum pressure decreases as leakage increases. When leakage value is the same as max. suction flow, vacuum pressure is near 0. In the case when ventrative or leaky work should be adsorbed, please note that vacuum pressure will not rise.

ZK2

ZQ

ZR

ZA

ZX

ZM

ZMA

ZL

ZH

ZU

ZYY

ZYX

Series ZR

Ejector Unit

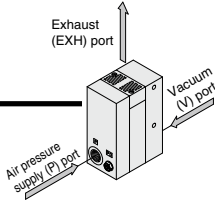

Nozzle Dia./ $\phi 1.0, \phi 1.3, \phi 1.5, \phi 1.8, \phi 2.0$

Nozzle dia./ $\phi 1.0, \phi 1.3, \phi 1.5$ mm

ZR1-W¹⁰₁₃□□

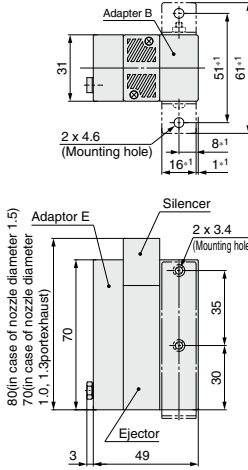
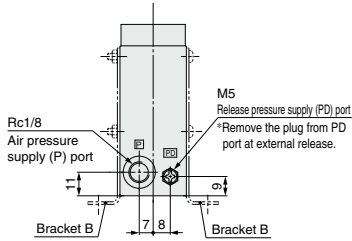
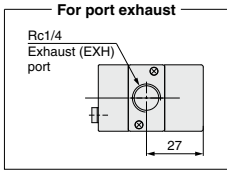

Circuit diagram

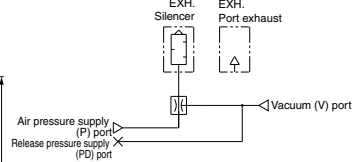

84 (in case of nozzle diameter 1.5)^{*1}
74 (in case of nozzle diameter 1.0, $\phi 1.3$ port exhaust)^{*1}

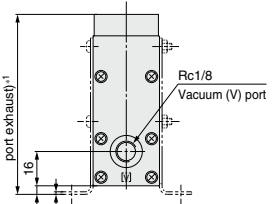

Note) *1 Dimensions : For mounting bracket B
Bracket B part number: ZR1-0BB
(Standard accessory)

Nozzle dia./ $\phi 1.8, \phi 2.0$ mm

ZR1-W¹⁸₂₀□□

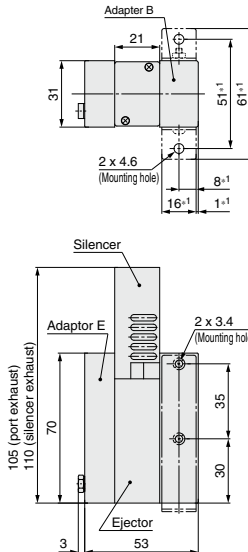
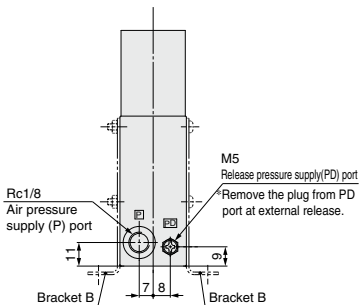
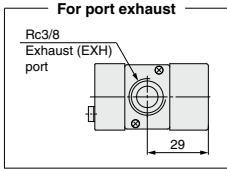

Circuit diagram

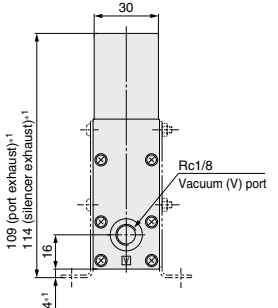
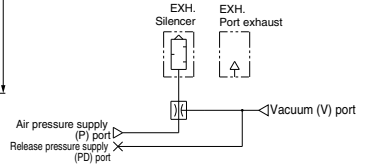

Pressure Switch Unit for Vacuum/Pressure Switch for Vacuum: ZSE2-0R-□□

Quick response: 10 mS

**Compact size: 39H x 20W x 15D
(except the connecting portion)**

Improved wiring: Connector style

Uses a carrier diffusion semiconductor pressure sensor

**Pressure detector
(A carrier diffusion semiconductor pressure sensor is used.)**

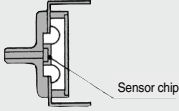

Specifications

Pressure switch for vacuum part no.	ZSE2-0R-15□	ZSE2-0R-55□
Fluid	Air	
Rated pressure range/Set pressure range	0 to -101 kPa	
Proof pressure	500 kPa	
Hysteresis	3% F.S. or less (Fixed)	
Temperature characteristics (Based on 25°C)	± 3% F.S. or less	
Operating voltage	12 to 24 VDC (Ripple ±10% or less)	
Output	NPN Open collector 30 V, 80 mA	PNP Open collector 80 mA
Indicator light	Lights up when ON	
Current consumption	17 mA or less (when 24 VDC is ON)	
Proof pressure (Max. operating pressure)	0.5 MPa*	
Operating temperature range	5 to 50°C	

* When using ejector system, instantaneous pressure up to 0.5 MPa will not damage the switch.
Note 1) Operation outside of the maximum operating pressure and operating temperature range may cause a serious accident or damage.
Note 2) For details about wiring, refer to the Operation Manual that can be downloaded from our website (<http://www.smcworld.com>).

How to Order

ZSE2 - 0R - 15 L

Output specifications

15	NPN Open collector 30V 80mA
55	PNP Open collector 80mA

Piping specifications

Nil	Grommet type	Lead wire length 0.6 m
L		Lead wire length 3 m
C		Lead wire length 0.6 m
CL	Connector type	Lead wire length 3 m
CN		W/o lead wire

With Connector/How to Order

- Without lead wire (housing and 3 sockets) ZS-10-A
- With lead wire ZS-10-5A-□

Lead wire length

Nil	0.6 m
30	3 m
50	5 m

Note) When requiring a switch with lead wire of 5 m, indicate separately the model numbers of the connector type switch without lead wire and the connector assembly with 5 m lead wire.

Example) ZSE2-0R-15CN 1 pc.
ZS-10-5A-50 1 pc.

* Refer to Best Pneumatics No. 6 for detailed specifications of pressure switches for vacuum.

ZK2

ZQ

ZR

ZA

ZX

ZM

ZMA

ZL

ZH

ZU

ZYY

ZYX

Pressure Switch Unit for Vacuum/Pressure Switch for Vacuum: ZSE2-0R-□□

Guidelines for Use of Pressure Switch Unit for Vacuum

System circuit for work adsorption

Ejector style

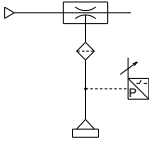

Vacuum pump style

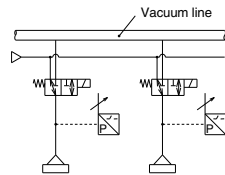

When pads and switches are common to one vacuum source, sometimes there is a possibility, depending on the number of adsorption and non-adsorption applications at each point in time, that the switches will not work within the range of set pressures due to pressure variations from the vacuum source. In particular, when small diameter nozzles are used for adsorption, the switches are greatly influenced by pressure variations. In order to remedy this situation, the following circuit is recommended.

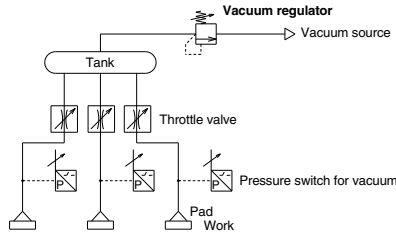

- Adjust the throttle valve to reduce the pressure fluctuation between adsorption and non-adsorption.
- Stabilize the source pressure by providing a tank and a vacuum regulator.
- If a vacuum switch valve is inserted into individual lines and false adsorption occurs, each valve should be turned OFF to minimize the influences on other pads.

Pressure Switch for Vacuum: ZSE2-0R-□□

ZSE2-0R-□
ZSE2-0R-□L

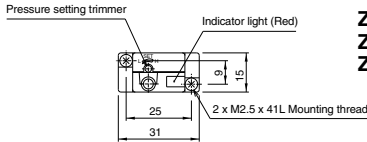

ZSE2-0R-□C
ZSE2-0R-□CL
ZSE2-0R-□CN

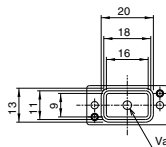
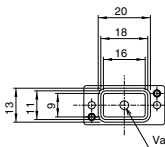
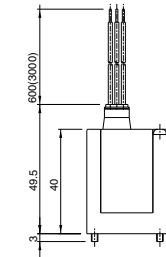
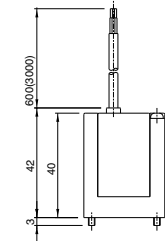
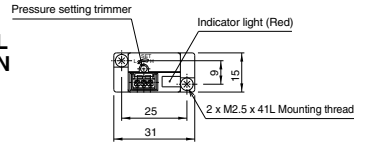

How to Set Vacuum Pressure

- Pressure trimmer selects the ON pressure. Clockwise rotation increases high vacuum set point.

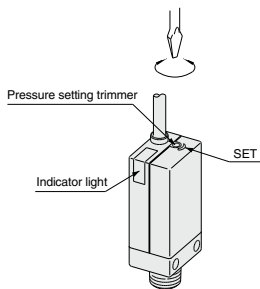

- When using the switch to confirm correct adsorption, the vacuum pressure is set to the minimum value to reliably adsorb. If the value is set below the minimum, the switch will be turned ON even when adsorption has failed or is insufficient. If the pressure is set too high, the switch may not operate stably even though it may adsorb correctly.

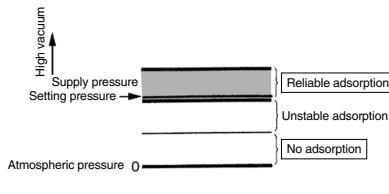

Hysteresis

Hysteresis is the actual pressure variance from set pressure occurring when the output signal turns from ON to OFF. The set pressure is the pressure selected to switch from OFF to ON mode.

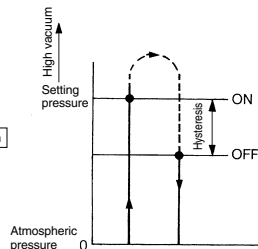

How to Use Connector

1. Attaching and detaching connectors

- When assembling the connector to the switch housing, push the connector straight onto the pins until the level locks into the housing slot.
- When removing the connector from the switch housing, push the lever down to unlock it from the slot and then withdraw the connector straight off of the pins.

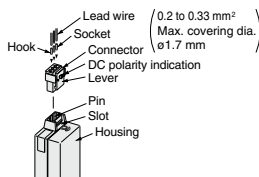

2. Crimping of lead wires and sockets

Strip 3.2 to 3.7 mm at the end of the lead wires, insert the ends of core wires evenly into the sockets, and then crimp with a crimping tool. When this is done, take care that the coverings of the lead wires do not enter the core wire crimping area. (Crimping tool: model no. DXT170-75-1)

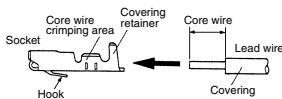

3. Attaching and detaching of socket to connector with lead wire

• Attaching

Insert the sockets into the square holes of the connector (with +, 1, 2, - indication), and continue to push the sockets all the way end. (When they are pushed in their hooks open and they are locked automatically.) Then confirm that they are locked by pulling lightly on the lead wires.

• Detaching

To detach a socket from a connector, pull out the lead wire while pressing the socket's hook with a stick having a thin tip (about 1 mm). If the socket will be used again, first spread the hook outward.

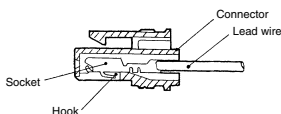

Precautions

Be sure to read before handling.
Refer to front matter 35 for Safety Instructions and pages 899 to 901 for Vacuum Equipment Precautions.

Mounting

Warning

1. Do not give an excessive impact load.

Do not drop, bump or apply excessive impact (1000 m/s²) when handling. Even if the switch body is not damaged, the switch may suffer internal damage that will lead to malfunction.

2. Hold the product from the body side when handling.

When raising and moving the product, do not raise it by holding the lead wire only, but hold the body. It may cause malfunction due to broken contacts.

ZK2

ZQ

ZR

ZA

ZX

ZM

ZMA

ZL

ZH

ZU

ZY

ZYX

Vacuum Pressure Switch Unit/Digital Pressure Switch for Vacuum:ZR1-ZSE30A-00-□-□□

Refer to Best Pneumatics No.6 for details.



How to Order

ZR1-ZSE30A-00-N-M□

Symbol	Output		Analog output	
	Type	Point	Voltage	Current
N	NPN	1	—	—
P	PNP	1	—	—
A	NPN	2	—	—
B	PNP	2	—	—
C	NPN	1	○	—
D	NPN	1	—	○
E	PNP	1	○	—
F	PNP	1	—	○

Option 1 (Connector/Lead wire specifications)	
Nil	Without lead wire
L	Lead wire with connector (Length 2 m)

Display unit	
Nil	With unit display switching function
M	Fixed SI unit
P	With unit display switching function (Initial value psi)

Note 1) This is no longer sold for use in Japan due to the Weight and Measure Act (implemented October, 1999).
Note 2) Fixed unit: kPa

Specifications

Rated pressure range	0.0 to -101.0 kPa	
Set pressure range	10.0 to -105.0 kPa	
Withstand pressure	500 kPa	
Minimum unit setting	0.1 kPa	
Applicable fluid	Air, Non-corrosive gas, Non-flammable gas	
Power supply voltage	12 to 24 VDC ±10% (with power supply polarity protection)	
Current consumption	40 mA (at no load)	
Switch output	NPN or PNP open collector 1 output NPN or PNP open collector 2 outputs (selectable)	
Maximum load current	80 mA	
Maximum applied voltage	28 V (at NPN output)	
Residual voltage	1 V or less (with load current of 80 mA)	
Response time	2.5 ms or less (with anti-chattering function: 20, 100, 500, 1000, 2000 ms)	
Short circuit protection	Yes	
Repeatability	±0.2% F.S. ±1 digit	
Hysteresis mode	Variable (0 to variable)	
Window comparator mode		
Analog output	Note 1) Voltage output (Rated pressure range)	1 to 5 V ±2.5% F.S.
	Note 2) Current output (Rated pressure range)	4 to 20 mA ±2.5% F.S.
Linearity		±1% F.S. or less
	Load impedance	Approx. 1 kΩ
Load impedance		Maximum load impedance: Power supply voltage 12 V: 300 Ω, Power supply voltage 24 V: 600 Ω
		Minimum load impedance: 50 Ω
Display	4-digit, 7-segment, 2-color LCD (Red/Green) Sampling cycle: 5 times/sec.	
Display accuracy	±2% F.S. ±1 digit (Ambient temperature of 25°C)	
Indicator light	Lights up when switch output is turned ON. (OUT1: Green, OUT2: Red)	
Environment resistance	Enclosure	IP40
	Operating temperature range	Operating: 0 to 50°C, Stored: -10 to 60°C (No freezing or condensation)
	Operating humidity range	Operating/Stored: 35 to 85% RH (No condensation)
	Withstand voltage	1000 VAC for 1 minute between terminals and housing
Temperature characteristics	Insulation resistance	50 MΩ or more (500 VDC measured via megohmmeter) between terminals and housing
		±2% F.S. (Based on 25°C)
Lead wire	Oilproof heavy-duty vinyl cable, 3 cores φ3.5, 2 m 4 cores Conductor area: 0.15 mm ² (AWG26) Insulator O.D.: 1.0 mm	
Standards	CE Marking, UL/CSA, RoHS compliance	

Note 1) When analog voltage output is selected, analog current output cannot be used together.
Note 2) When analog current output is selected, analog voltage output cannot be used together.

3-step setting

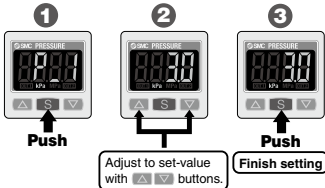

Power-saving function

Power consumption is reduced by turning off the monitor. (Reduce power consumption by up to 20%.)

*The vacuum pressure switch mounted on this product is equivalent to our SMC product, the ZSE30A series compact digital pressure switch.

●Pressure switch correspondence table

Digital pressure switch Series ZSE30A

Large size vacuum module Series ZR

Vacuum pressure switch (For ZR)

ZSE30A-00-□-□-□-□

ZR1※※※※※※※※※※-D-□-□-□-□-□-□

ZR-ZSE30A-00-□-□-□-□

For details about vacuum pressure switch functions, refer to the Operation Manual for Series ZSE30A that can be downloaded from our website (<http://www.smcworld.com>).

Lead wire specifications
Unit specifications
Output specifications

Pressure Switch for Vacuum + Suction Filter Unit: ZR1-F□□□□-□

Combination unit of vacuum pressure switch for vacuum pressure detection and suction filter to protect the unit from dust and contamination.

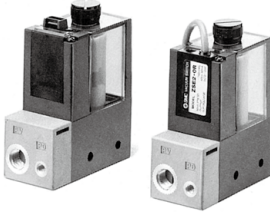

Filter case

Caution

- The case is made of polycarbonate. Therefore, do not contact it or expose it to the following chemicals: paint thinner, carbon tetrachloride, chloroform, acetic ester, aniline, cyclohexane, trichloroethylene, sulfuric acid, lactic acid, water soluble cutting oil (alkalinity), etc.
- Do not expose it to direct sunlight.

How to Replace Elements

When an element becomes clogged, adsorption performance and response times are degraded. Stop operation and replace element. (Element no. ZR1-FZ). Please ensure that gasket is in slot before re-installation.

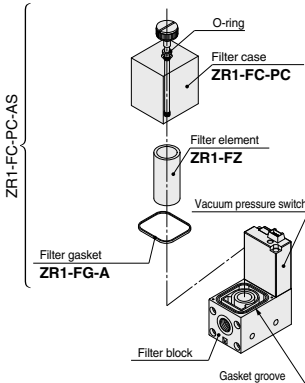

Specification

Unit no.		ZR1-F□□□□-□
Suction filter	Rated pressure range/Set pressure range	-100 to 100 kPa
	Proof pressure	500 kPa
	Operating temperature range	5 to 50°C
	Filtration degree	30 μm
Filtration material		PVF
Pressure switch for vacuum		Refer to pages 985 and 988 regarding pressure switch for vacuum.
Standard option		Bracket A (ZR1-OBA)

Note) If not operated within the specified range of pressure and temperature, trouble may be caused.

Combination of Pressure Switch for Vacuum and Suction Filter

Combination symbol	Suction filter	Pressure switch for vacuum	Weight (with bracket A) (kg)
E	●	ZSE2	0.15
D	●	ZSE30A	0.23
F	●	—	0.15

How to Order

ZR1 - F □ □ □ □ - □

Combination of pressure switch/filter

D	Digital pressure switch for vacuum (ZSE30A) + Filter
E	Pressure switch for vacuum (ZSE2) + Filter
F	Filter

*The filter mounted on the product is a simplified one. When used in an environment with a lot of dust, the built-in filter is likely to be clogged soon. The use with the ZFA, ZFB and ZFC series is recommended.

Output specifications

Digital pressure switch for vacuum (ZSE30A) specifications (D)

N	NPN open collector 1 output
P	PNP open collector 1 output
A	NPN open collector 2 outputs
B	PNP open collector 2 outputs
C	NPN open collector 1 output + Analog voltage output
D	NPN open collector 1 output + Analog current output
E	PNP open collector 1 output + Analog voltage output
F	PNP open collector 1 output + Analog current output

Pressure switch for vacuum (ZSE2) specifications (E)

Nil	NPN open collector 1 output
55	PNP open collector 1 output

Filter specifications (F)

Nil	No setting
-----	------------

How to order

When requiring a switch with lead wire of 5 m, indicate separately the model numbers of a pressure switch unit for vacuum without a lead wire connector and the 5 m lead wire connector. Ex.) ZR1□□□-□□□□□-□CN 1 pc.
* ZS-10-5A-50 2 pcs.

(1) Lead wire length for pressure switch for vacuum connector assembly

ZS - 10 - 5A - □

Lead wire length	
Nil	0.6 m
30	3 m
50	5 m

(2) Lead wire length for digital pressure switch for vacuum connector assembly

ZS - 38 - 3 L

Lead wire core	
3	3 cores, 1 output, 2 m (Output specifications: N, P)
4	4 cores, 2 outputs, 2 m (Output specifications: A, B, C, D, E, F)

Bracket A

Nil	With Bracket A
N	Without Bracket A

Lead wire specifications

Digital pressure switch for vacuum (ZSE30A) specifications (D)

Nil	Without lead wire
L	Lead wire with connector (Length 2 m)

Refer to "Table (2)" for part numbers for lead wire with connector.

Pressure switch for vacuum (ZSE2) specifications (E)

Nil	Grommet/Lead wire (Length 0.6 m)
L	Grommet/Lead wire (Length 3 m)
C	Lead wire with connector (Length 0.6 m)
CL	Lead wire with connector (Length 3 m)
CN	Without lead wire with connector

Refer to "Table (1)" for part numbers for lead wire with connector.

Filter specifications (F)

Nil	No setting
-----	------------

Unit specifications

Digital pressure switch for vacuum (ZSE30A) specifications (D)

Nil	With unit switching function
M	SI unit only
P	With unit switching function (Initial value psi)

Note 1) This is no longer sold for use in Japan due to the Weight and Measure Act (implemented October, 1999).
Note 2) Fixed unit: kPa

Pressure switch for vacuum (ZSE2) specifications (E)

Nil	No setting
-----	------------

Filter specifications (F)

Nil	No setting
-----	------------

ZK2

ZQ

ZR

ZA

ZX

ZM

ZMA

ZL

ZH

ZU

ZYY

ZYX

Series ZR

Pressure Switch for Vacuum + Suction Filter Unit: ZR1-F□□□□

Dimensions: ZR1-F□□□□

ZR1-FE□□□□

Circuit diagram

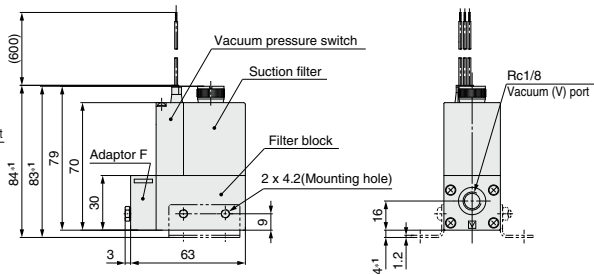
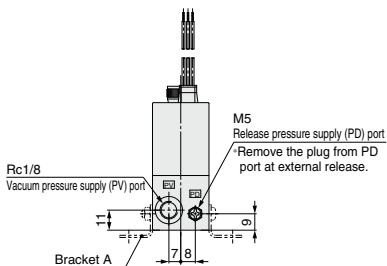
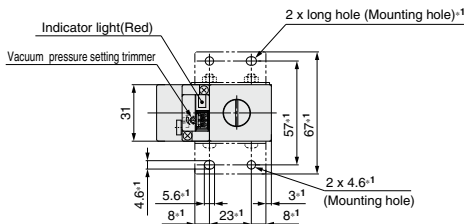
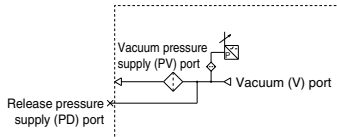

ZR1-FD□□□□

Circuit diagram

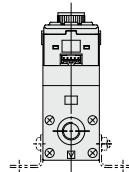
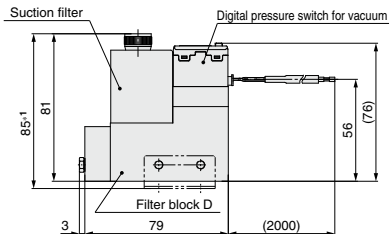
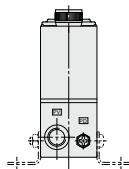
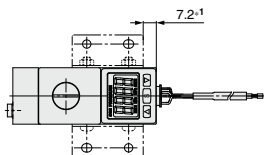
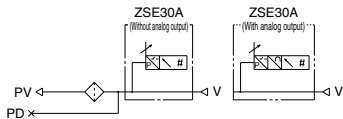

Note) * 1 Dimensions : For mounting bracket A
Bracket A part number: ZR1-OBA (standard)

Suction Filter: ZR1-FX-□

ZR1-FX is to be used alone and cannot be combined with other units.

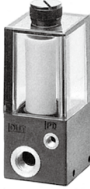

Filter case

Caution

1. The case is made of polycarbonate. Therefore, do not use it with or expose it to the following chemicals: paint thinner, carbon tetrachloride, chloroform, acetic ester, aniline, cyclohexane, trichloroethylene, sulfuric acid, lactic acid, water soluble cutting oil (alkalinic), etc.
2. Do not expose it to direct sunlight.

Specification

Model	ZR1-FX-□
Operating pressure range	-0.1 to 0.5 MPa
Operating temperature range	5 to 50°C
Filtration efficiency	30 μm
Element	PVF
Weight (With bracket)	0.1 kg
Standard	Bracket C (ZR1-OBC)

How to Order

ZR1-FX-□

Bracket C

Nil	With Bracket C
N	Without Bracket C

- ZK2
- ZQ
- ZR
- ZA
- ZX
- ZM
- ZMA
- ZL
- ZH
- ZU
- ZYY
- ZYX

Dimensions: ZR1-FX-□

Circuit diagram

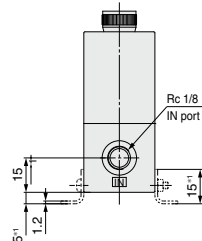
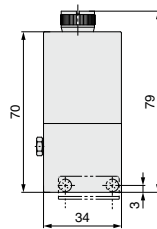
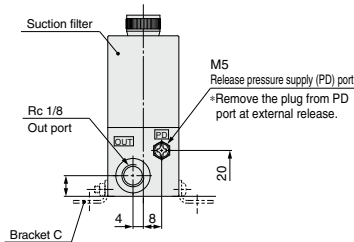
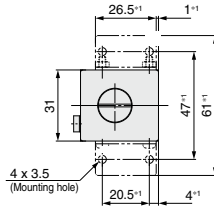
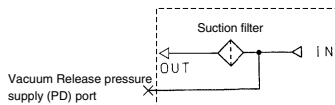

Note) *1 Dimensions for mounting bracket C
Bracket C part no. : ZR1-OBC (Standard accessory)

Series ZR

Ejector System Complete Unit

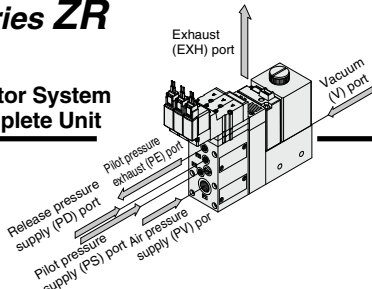

<Components> Ejector + Valve + Pressure Switch for Vacuum + Filter

Nozzle dia. $\phi 1.0, \phi 1.3, \phi 1.5$

ZR1¹⁰₁₃ □1-K1□M□□-E□□-□
15

Circuit diagram Pressure switch for vacuum (E)

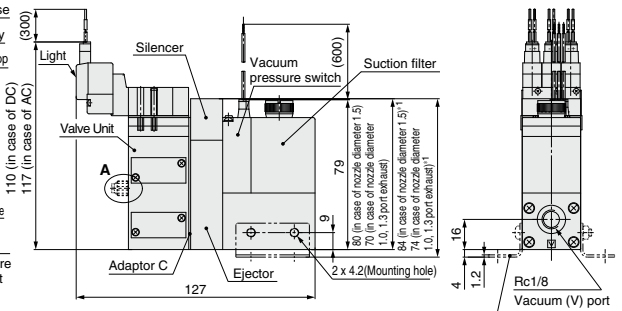
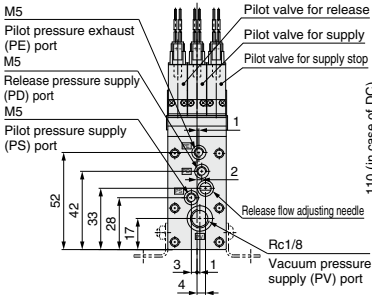
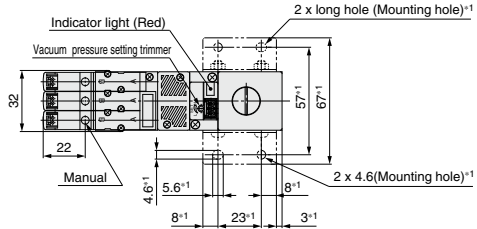
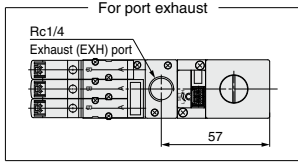
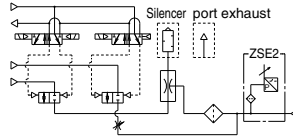

ZR1¹⁰₁₃ □1-K1□M□□-D□□□-□
15

A: Release flow adjusting needle with lock nut

Circuit diagram Digital pressure switch for vacuum (D)

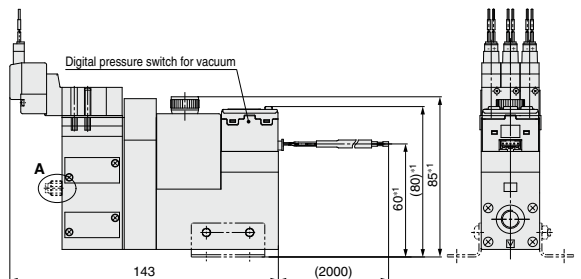
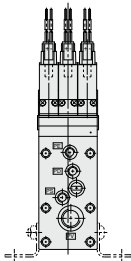
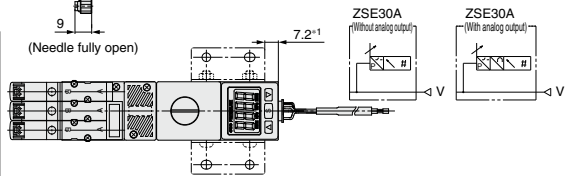
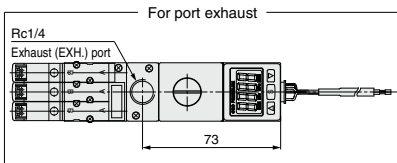

Nozzle dia./ $\phi 1.8, \phi 2.0$

ZR1¹⁸₂₀□1-K1□M□□-E□□-□

Note) *1 Dimensions for mounting bracket A
*2 Dimensions for mounting spacer A
Bracket A part no. : ZR1-OBA
(Standard accessory)

A: Release flow adjusting
needle with lock nut

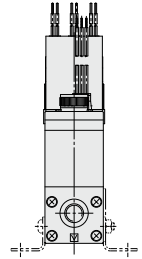
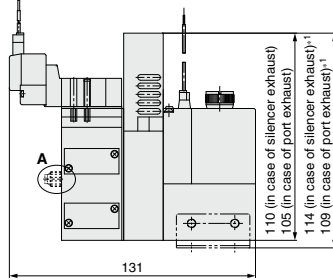
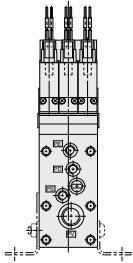
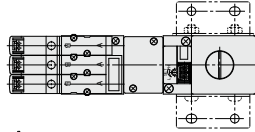
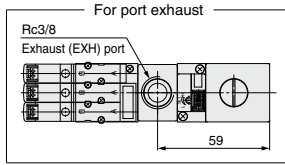
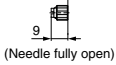

★ Dimensions not indicated are identical to the drawing on page 992.

ZR1¹⁸₂₀□1-K1□M□□-D□□□-□

In case of Port exhaust

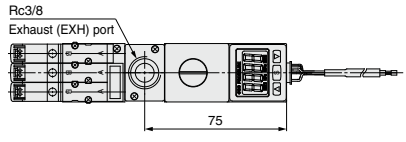

A: Release flow adjusting
needle with lock nut

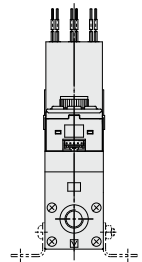
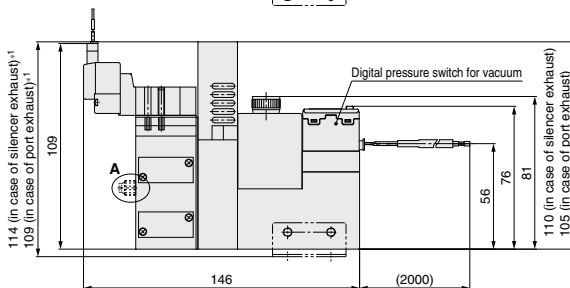
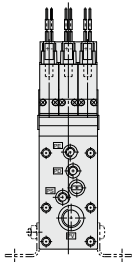
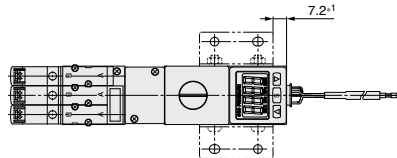
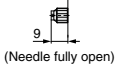

Series ZR

Ejector System

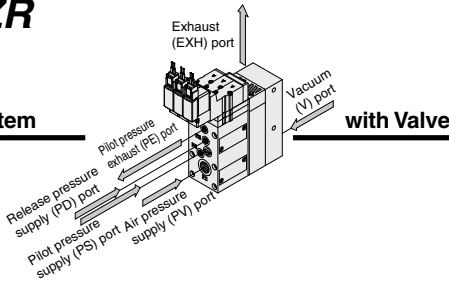

Circuit diagram

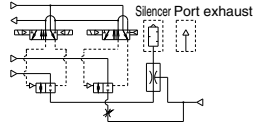

Nozzle dia./ø1.0, ø1.3, ø1.5

ZR1¹⁰₁₃□1-K1□M□□-□

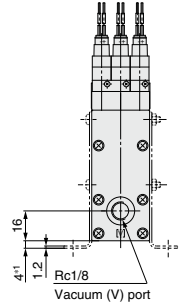
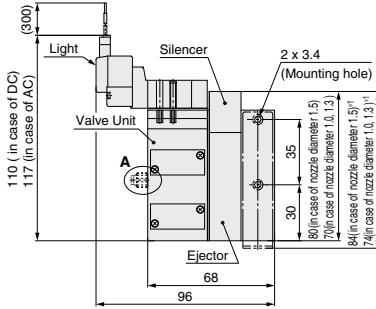
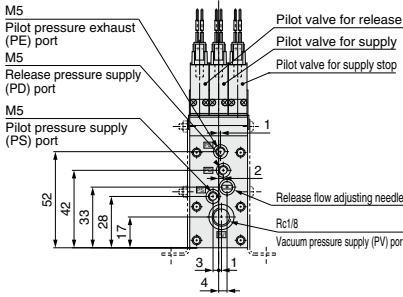
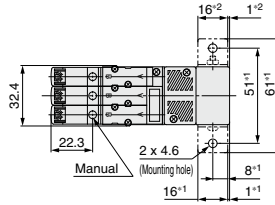
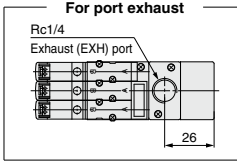

Nozzle dia./ø1.8, ø2.0

ZR1¹⁸₂₀□1-K1□M□□-□

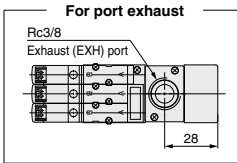

A: Release flow adjusting needle with lock nut

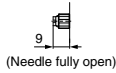

Note) *1 Dimensions for mounting bracket B
Bracket B part no.: ZR1-0BB
(Standard accessory)

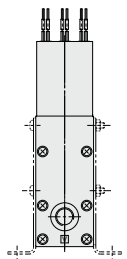
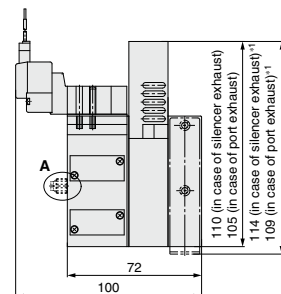
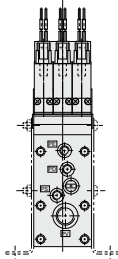
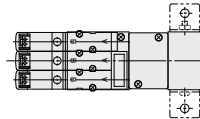

* Dimensions not indicated are identical to the top drawing.

ZK2
ZQ
ZR
ZA
ZX
ZM
ZMA
ZL
ZH
ZU
ZYY
ZYX

Series ZR

Ejector System

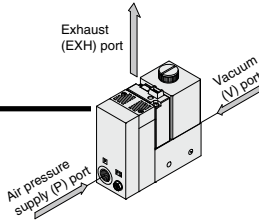

without Valve

Nozzle dia./ $\phi 1.0, \phi 1.3, \phi 1.5$

ZR1¹⁰₁₃□1-E□□
15

For port exhaust

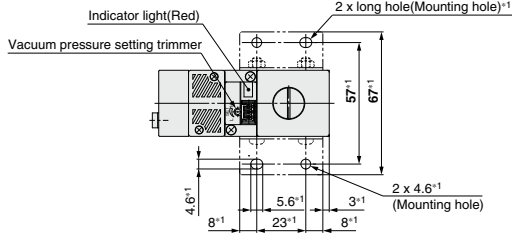
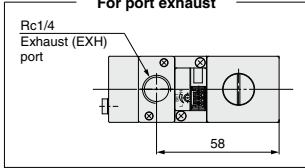

Circuit diagram

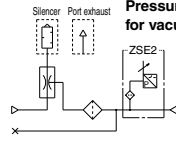

Pressure switch for vacuum (E)

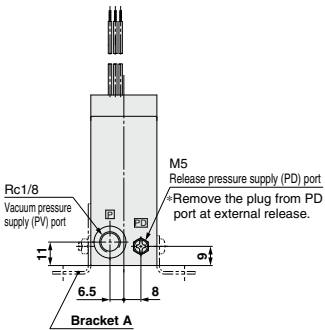

ZR1¹⁰₁₃□1-D□□□
15

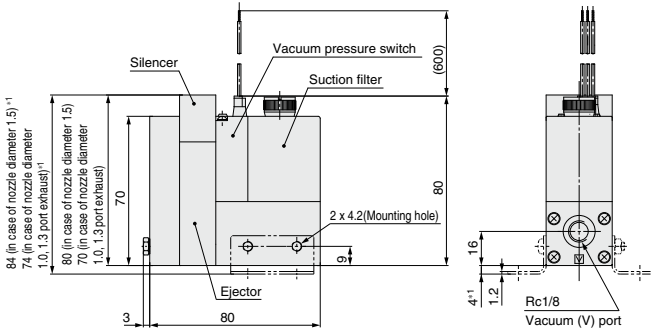

For port exhaust

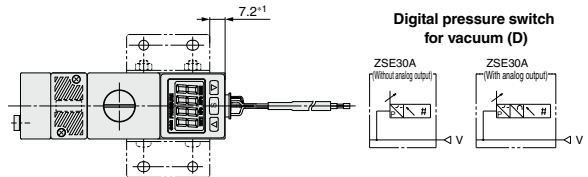
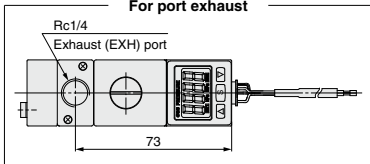

Digital pressure switch for vacuum (D)

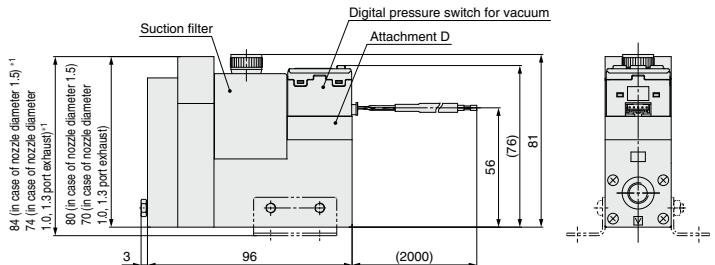
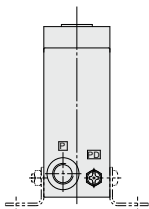

Large Size Vacuum Module: Ejector System **Series ZR**

Nozzle dia./ ϕ 1.8, ϕ 2.0

ZR18
ZR20 □1-E□□

Note) * 1 Dimensions for mounting bracket A
Bracket A part no.: ZR1-OBA
(Standard accessory)

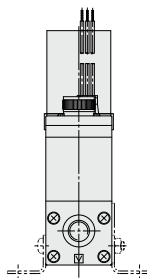
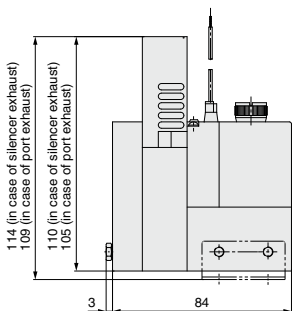
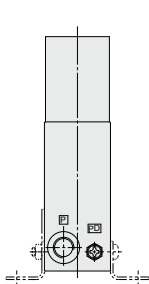
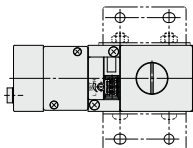
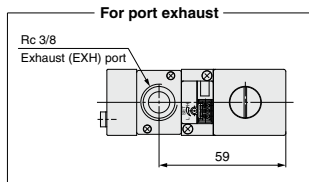

ZR18
ZR20 □1-D□□□

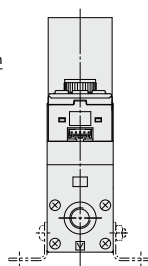
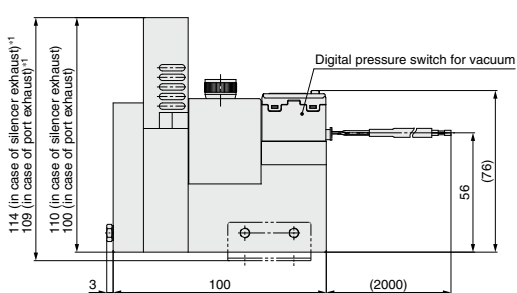
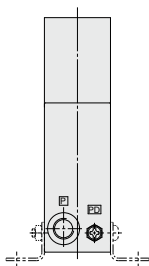
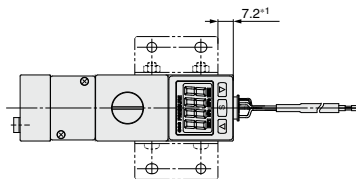
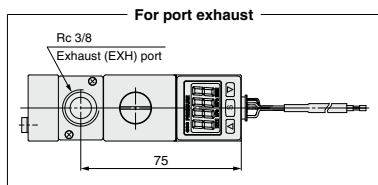

★ Dimensions not indicated are identical to the top drawing.

ZK2
ZQ
ZR
ZA
ZX
ZM
ZMA
ZL
ZH
ZU
ZYY
ZYX

Ejector System/Manifold Specifications



Specifications

Max. number of units	Max. 6 stations
Port	Port size
Common air pressure supply (PV) port	1/8 (Rc, NPTF, G)
Common pilot pressure supply (PS) port	M5
Common release pressure supply (PD) port	M5
Common exhaust (EXH.) port	1/2 (Rc, NPTF, G)
Weight (Manifold bases only)	Basic mass for one station is 0.28 kg. Additional mass per one station is 0.12 kg.

- (1) When using 3 or more stations with ZR120□□ manifold, utilize PV port as supply port on both sides.
 (2) When using 3 or more stations with ZR120□□ manifold, utilize EXH port as exhaust port on both sides.

Manifold Air Supply

Supply port location	Manifold Port					
	Left			Right		
	PV	PS	PD	PV	PS	PD
L (Left side)	○	○	○	●	●	●
R (Right side)	●	●	●	○	○	○
B (Both sides)	○	○	○	○	○	○

Air supply to ○ port
 BLANK plug attached to ● port
 Note) BLANK plug is attached on all ports of valve unit.

Individual Spacer

Part no.	Port	Function
ZR1-R1 to R16	PV	Possible to set the air supply pressure individually
	PS	Possible to set the pilot valve air supply pressure individually
	PD	Possible to set the release valve supply pressure individually
	PE	Possible to set the pilot valve exhaust individually

Individual spacer is used when the connecting port of each unit is not common for the manifold connecting port. Mixed specifications of common and individual unit connecting ports for each unit is possible on manifolds with this individual spacer.

How to Order Manifold

<Manifold base>

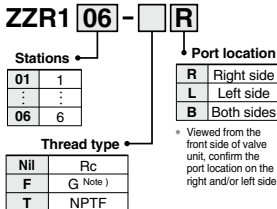

Note 1) The thread ridge shape is compatible with the G thread standard (JIS B 0202), but other shapes are not conforming to ISO16030 and ISO1179.

- Example 1)
 ZZR106-R 1 pc. (Manifold base only)
 * ZR120S1-K15MZ-EC ... 5 pcs. (Unit)
 * ZR1-BM1 1 pc. (Blank plate)
 * ZR1-R1-3 1 pc. (Individual spacer)

↓ With reference from valve side, the third station from right side

<Function plate>

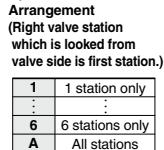
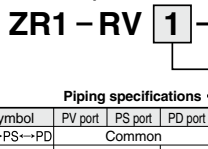

* When the spacers are attached to the specified locations, specify all spacers.

- Example 2) Attached to the first and third stations
 =ZR1-RV1-1
 =ZR1-RV1-3
- Example 3) Attached to all stations.
 =ZR1-RV1-A-3

↑ Fill the number

<Individual spacer>

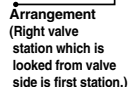
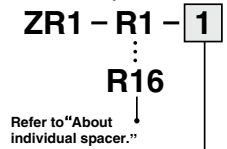

* When the spacers are attached to the specified locations, specify all spacers.

- Example 4) Attached to the first and third stations
 =ZR1-R1-1
 =ZR1-R1-3

⚠ Caution when ordering manifold

The asterisk denotes the symbol for assembly. Prefix it to the ejector part numbers to be mounted. When it is not added, the manifold base and ejector are shipped separately.

About individual spacers

- In the right table, ports with the symbol ↓ mean that they are manifold supply, while others are individual supply from the valve unit.
- Symbols in the right table are printed on the surface of individual spacers.

Part no.	Symbol	Part no.	Symbol
ZR1-R1	R1	ZR1-R9	R9 ↓PV
-R2	R2 ↓PE	-R10	R10 ↓PV ↓PE
-R3	R3 ↓PD	-R11	R11 ↓PV ↓PD
-R4	R4 ↓PD ↓PE	-R12	R12 ↓PV ↓PD ↓PE
-R5	R5 ↓PS	-R13	R13 ↓PV ↓PS
-R6	R6 ↓PS ↓PE	-R14	R14 ↓PV ↓PS ↓PE
-R7	R7 ↓PS ↓PD	-R15	R15 ↓PV ↓PS ↓PD
-R8	R8 ↓PS ↓PD ↓PE	-R16	R16 ↓PV ↓PS ↓PD ↓PE

<Blanking plate>

ZR1 - BM1

Refer to Example 1).

Manifold/System Circuit Example

When not using individual spacer

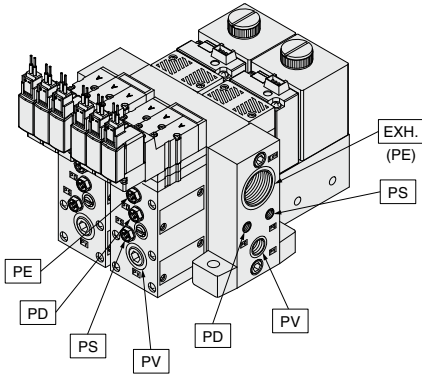

PV: Air pressure supply port
PS: Pilot pressure supply port
PD: Release pressure supply port
PE: Pilot pressure exhaust port
EXH.: Common exhaust port
V: Vacuum Port

When using individual spacer

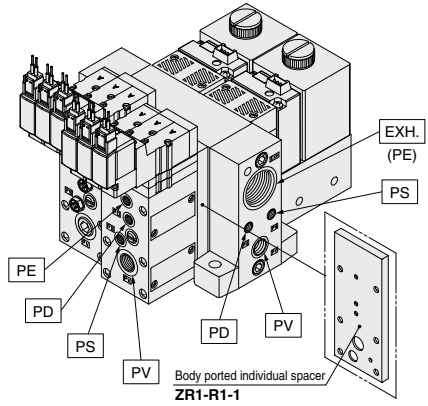

PV: Air pressure supply port
PS: Pilot pressure supply port
PD: Release pressure supply port
PE: Pilot pressure exhaust port
EXH.: Common exhaust port
V: Vacuum Port

ZK2
ZQ
ZR
ZA
ZX
ZM
ZMA
ZL
ZH
ZU
ZYY
ZYX

<System circuit example>

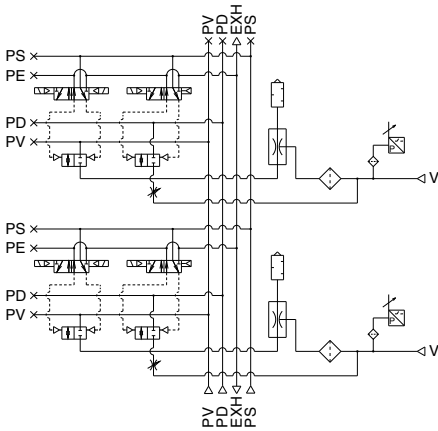

<System circuit example>

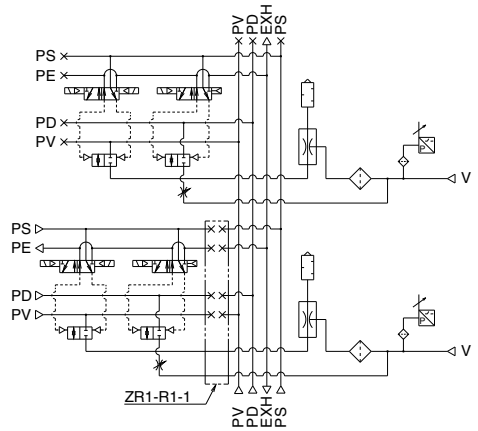

Series ZR

Ejector System

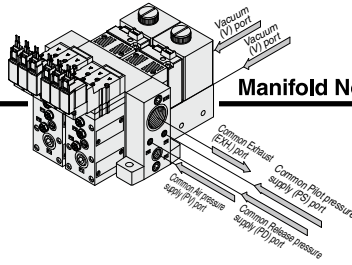

Manifold Nozzle Dia./ \varnothing 1.0, \varnothing 1.3, \varnothing 1.5

A: Release flow adjusting needle with lock nut

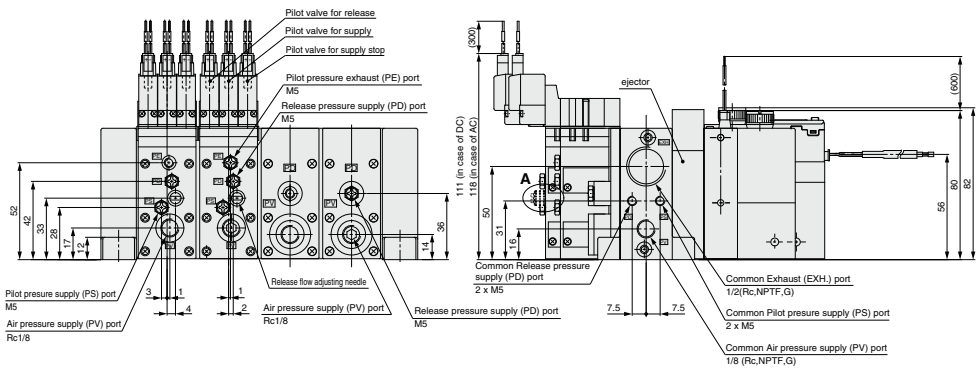
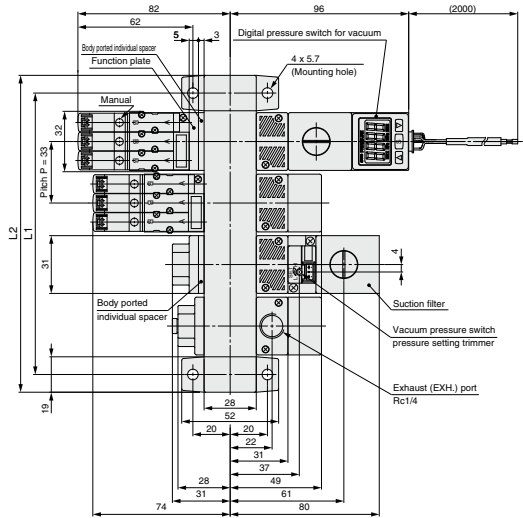
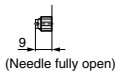

* 1 The common exhaust (EXH.) port is also used as the pilot pressure exhaust (PE) port of the pilot valve. Use while the port is open to the atmosphere.

		(mm)					
Symbol	Stations	1	2	3	4	5	6
L1		52	85	118	151	184	217
L2		71	104	137	170	203	236

Circuit diagram

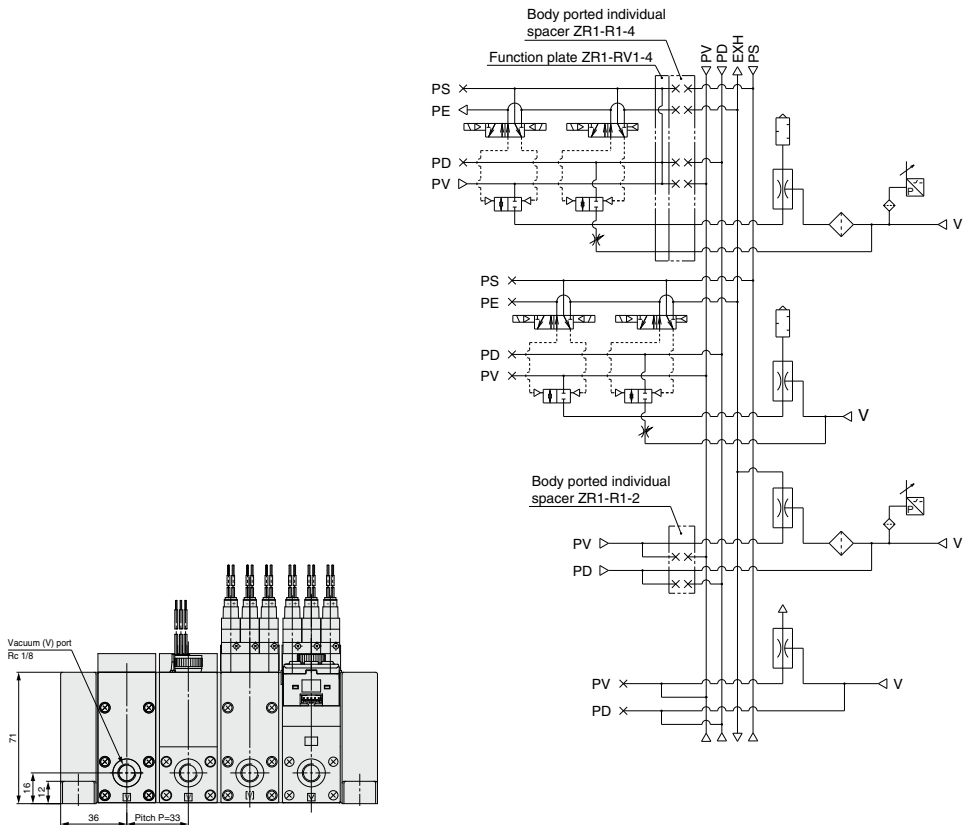

ZK2
ZQ
ZR
ZA
ZX
ZM
ZMA
ZL
ZH
ZU
ZYY
ZYX

PV: Air pressure supply port
PS: Pilot pressure supply port
PD: Release pressure supply port
PE: Pilot pressure exhaust port
EXH.: Exhaust port
V: Vacuum Port

Circuit diagram

ZK2
ZQ
ZR
ZA
ZX
ZM
ZMA
ZL
ZH
ZU
ZYY
ZYX

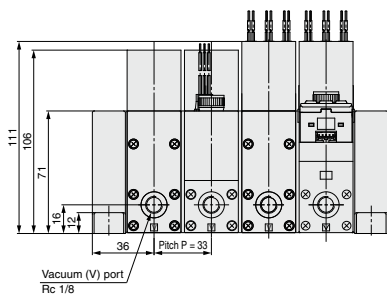
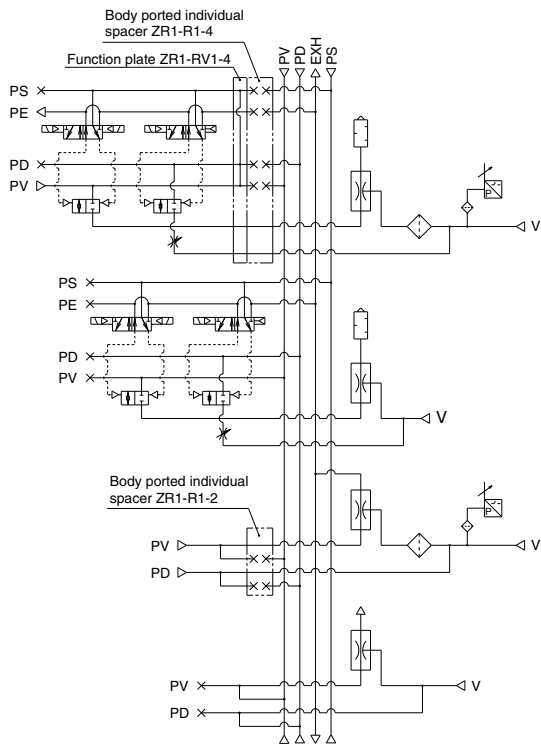

PV: Air pressure supply port
PS: Pilot pressure supply port
PD: Release pressure supply port
PE: Pilot pressure exhaust port
EXH.: Common exhaust port
V: Vacuum Port

Large Size Vacuum Module: Vacuum Pump System Series ZR



[Option]
Note) CE-compliant:
For DC only.



How to Order

Note for model selection

Take function plates into consideration.
(Refer to page 1007.)

Components

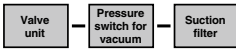

ZR100 - **K1** **5** **M** **Z** - **D** - - - - -

Combination of vacuum valve and release valve
Refer to "Table (1)" in page 1005 for details.

Solenoid valve rated voltage	CE-compliant
NII (Note)	Air operated
5	24 VDC
6	12 VDC
V	6 VDC
S	5 VDC
R	3 VDC
D1 (Note)	100 VAC (50/60Hz)
D2 (Note)	110 VAC (50/60Hz)

Note) Air operated, 100 VAC, and 110 VAC type are not CE-compliant.

Electrical entry

NII		Air operated
For 24, 12, 6, 5, 3 VDC		
L	L plug	Lead wire length 0.3 m
LN	connector	Without lead wire
LO	type	Without connector
M	M plug	Lead wire length 0.3 m
MN	connector	Without lead wire
MO	type	Without connector
G	Grommet	Lead wire length 0.3 m (Applicable to only DC)
H	type	Lead wire length 0.6 m (Applicable to only DC)

• Refer to "Table (2)" on page 1005 for part no. of lead wire with connector.

Light/Surge voltage suppressor

NII	None
Z	With light/surge voltage suppressor
S	With surge voltage suppressor

• DC voltage: Be much careful about polarity, because it is incorrect at DC (surge voltage suppressor), diode or switching element may be damaged.
AC voltage: S is not available for AC.

Manual override

NII	Non-locking push type
B	Slotted locking type

Combination of switch/filter

D	Digital pressure switch for vacuum (ZSE30A) + Filter
E	Pressure switch for vacuum (ZSE2) + Filter
F	Filter

Combination of safety switch valve and release valve
Refer to "Table (1)"
Solenoid valve rated voltage
Electrical entry
Light/Surge voltage suppressor
Manual override
Combination of switch/filter
Output specifications
Unit specifications
Lead wire specifications
Release flow rate adjusting needle/Bracket A or B

CE-compliant

NII	—
Q	CE-compliant (DC only)

Release flow rate adjusting needle/Bracket A, B

	Lock nut	Bracket A or B
NII	×	●
L	●	●
M	×	×
N	×	×

● : Attached (Bracket A or B is shipped together.)
× : None

Lead wire specifications

Digital pressure switch for vacuum (ZSE30A) specifications (D)

NII	Without lead wire
L	Lead wire with connector (Length 2 m)

Refer to "Table (4)" on page 1005 for part no. of lead wire with connector.

Pressure switch for vacuum (ZSE2) specifications (E)

NII	Grommet/Lead wire (Length 0.6 m)
L	Grommet/Lead wire (Length 3 m)
C	Lead wire with connector (Length 0.6 m)
CL	Lead wire with connector (Length 3 m)
CN	With connector/Without lead wire

Refer to "Table (3)" on page 1005 for part no. of lead wire with connector.

Filter specifications (F)

NII	No setting
------------	------------

Unit specifications

Digital pressure switch for vacuum (ZSE30A) specifications (D)

NII	With unit switching function
M	SI unit only
P	With unit switching function (Initial value psi)

Note 1) This is no longer sold for use in Japan due to the Weight and Measure Act (implemented October, 1999).

Note 2) Fixed unit: kPa

Pressure switch for vacuum (ZSE2) specifications (E)

NII	No setting
------------	------------

Filter specifications (F)

NII	No setting
------------	------------

Output specifications

Digital pressure switch for vacuum (ZSE30A) specifications (D)

N	NPN open collector 1 output
P	PNP open collector 1 output
A	NPN open collector 2 outputs
B	PNP open collector 2 outputs
C	NPN open collector 1 output + Analog voltage output
D	NPN open collector 1 output + Analog current output
E	PNP open collector 1 output + Analog voltage output
F	PNP open collector 1 output + Analog current output

Pressure switch for vacuum (ZSE2) specifications (E)

NII	NPN open collector 1 output
55	PNP open collector 1 output

Filter specifications (F)



NII	No setting
------------	------------

ZK2
ZQ
ZR
ZA
ZX
ZM
ZMA
ZL
ZH
ZU
ZYY
ZYX

Table (1) Valve Unit/Combination of Vacuum Switch Valve and Release Valve

Valve unit function			Valve unit components		Symbol	Supply valve				Release valve			
Operation stop	Vacuum adsorption	Vacuum release	Supply valve	Release valve		Solenoid valve			Air operated (SYJA3130)	Solenoid valve			Air operated (SYJA3130)
						Double SOL. (SYJ3233-X126)	Double SOL. (SYJ3233-X127)	N.C. (SYJ3133)		Double SOL. (SYJ3233-X126)	Double SOL. (SYJ3233-X127)	N.C. (SYJ3133)	
☉	☉	○	Double SOL. (SYJ3233-X126)	N.C. (SYJ3133)	K1	●	—	—	—	—	—	●	—
○	○	○	N.C. (SYJ3133)	N.C. (SYJ3133)	K2	—	—	●	—	—	—	●	—
○	○	○	Air operated (SYJA3130)	Air operated (SYJA3130)	K3	—	—	—	●	—	—	—	●
×	○	○	N.C. (SYJ3133)		C1	—	—	●	—	—	—	(Common with supply valve)	—
×	○	○	Air operated (SYJA3130)		C2	—	—	—	●	—	—	—	(Common with supply valve)
×	○	○	N.O. (SYJ3133)		C3	—	—	●	—	—	—	(Common with supply valve)	—
×	☉	☉	Double SOL. (SYJ3233-X127)		C4	—	●	—	—	—	(Common with supply valve)	—	—
<small>○: Possible ☉: Possible with limitations (without self-locking function) ×: Not possible</small>					NII	Without valve module							

Table (2) How to Order Valve Plug Connector Assembly

DC	SY100-30-4A	
For 100 VAC:	SY100-30-1A	
For other voltages of AC (with rectifier)	SY100-30-3A	

Lead wire length	
NII	300 mm (Standard)
6	600 mm
10	1000 mm
15	1500 mm
20	2000 mm
25	2500 mm
30	3000 mm
50	5000 mm

How to order

When requiring a vacuum unit equipped with valves with lead wires of 600 mm or more, specify the vacuum module valves without the standard connectors and order the required connector ass'ys separately.

Example) ZR100-K15M□Z-EC (-Q) 1 pc.
* SY100-30-4A-6 3 pcs.

Table (3) Pressure Switch for Vacuum/Lead Wire with Connector

ZS-10-5A	
-----------------	---

Lead wire length	
NII	0.6 m
30	3 m
50	5 m

How to order

When requiring a vacuum switch with a lead wire of 5 m, indicate the part numbers of the vacuum unit switch without a lead wire with connector and the 5 m lead wire connector separately.

Example) ZR100-□□□□□-□CN (-Q) 1 pc.
* ZS-10-5A-50 1 pc.

Table (4) Digital Pressure Switch for Vacuum/Lead Wire with Connector

ZS-38-3		L
----------------	---	----------

Lead wire core	
3	3 cores, 1 output, 2 m (Output specifications: N, P)
4	4 cores, 2 outputs, 2 m (Output specifications: A, B, C, D, E, F)

Vacuum Pump System/Combination of supply valve and release valve

Combination Symbol : K1

Feature : Double solenoid vacuum valve allows for self-holding.

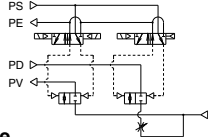

How to Operate

Operation	Pilot valve operation	Supply valve	Release valve	Note
	Pilot valve for supply	Pilot valve for supply stop	Pilot valve for release	
1. Adsorption	ON	OFF	OFF	When power supply is cut off while the supply valve is ON, the operational state is held.
2. Vacuum release	OFF	ON	ON	
3. Operation stop	OFF	ON	OFF	

Combination Symbol : K2

Feature: Single solenoid valve is provided for vacuum valve.

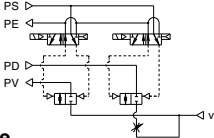

How to Operate

Operation	Pilot valve operation	Supply valve	Release valve	Note
	Pilot valve for supply	Pilot valve for release		
1. Adsorption	ON	OFF	OFF	When power supply is stopped, all operations will be stopped.
2. Vacuum release	OFF	ON	ON	
3. Operation stop	OFF	OFF	OFF	

Combination Symbol : K3

Feature: Operation can be controlled by an external pilot valve.

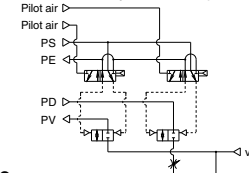

How to Operate

Operation	Pilot valve operation	Supply valve	Release valve	Note
	Air operated a	Air operated b		
1. Adsorption	ON	OFF	OFF	The product is used under the environment in which solenoid valves cannot be used or when the centralized control is applied using external pilot air.
2. Vacuum release	OFF	ON	ON	
3. Operation stop	OFF	OFF	OFF	

⚠ Caution

When pipe connection is made to two port connections (PV) port, (PD) port only, use a function plate (ZR1-RV3). Refer to page 1007 for further information.

Combination Symbol : C1

Feature: Adsorption of workpieces (when energized) and release of vacuum (when de-energized) are switched by single solenoid valve.

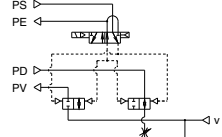

How to Operate

Operation	Pilot valve operation	Supply valve/Release valve	Note
	Pilot valve for supply/release		
1. Adsorption	ON	ON	Be careful for blowing off of workpieces or displacement of adsorption position in case of small and/or lightweight workpieces.
2. Vacuum release	OFF	OFF	

Combination Symbol : C2

Feature: Adsorption of workpieces and release of vacuum are switched by an external pilot valve.

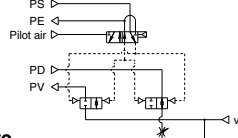

How to Operate

Operation	Pilot valve operation	Supply valve/Release valve	Note
	Air operated a		
1. Adsorption	ON	ON	Be careful for blowing off of workpieces or displacement of adsorption position in case of small and/or lightweight workpieces.
2. Vacuum release	OFF	OFF	

Combination Symbol : C3

Feature: Adsorption of workpieces (when de-energized) and release of vacuum (when energized) are switched by the single solenoid valve.

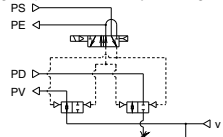

How to Operate

Operation	Pilot valve operation	Supply valve/Release valve	Note
	Pilot valve for supply/release		
1. Adsorption	OFF	ON	Be careful for blowing off of workpieces or displacement of adsorption position in case of small and/or lightweight workpieces.
2. Vacuum release	ON	ON	

Combination Symbol : C4

Feature: Adsorption of workpieces and release of vacuum are switched by double solenoid valve.

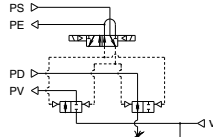

How to Operate

Operation	Pilot valve operation	Supply valve/Release valve	Note
	Pilot valve for supply	Pilot valve for release	
1. Adsorption	ON	OFF	When power supply is stopped vacuum valve/vacuum release valve will hold the operation.
2. Vacuum release	OFF	ON	

Function Plate : ZR1-RV3

A function plate is used when each connecting port for the valve unit is common. If a function plate is not used (standard), make individual pipe connections to PV, PS, and PD ports respectively.

Without Function Plate (Standard)

Applicable system: Ejector system
External vacuum supply system

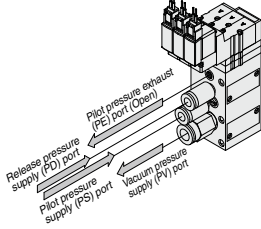

Pipe connection

Example of circuit diagram

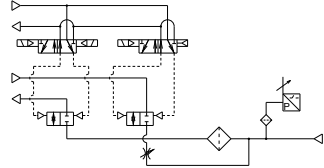

With Function Plate/Applicable to Vacuum Pump System Only

When ZR1-RV3 (PV/PS PD) is Selected

Since compressed air is necessary to operate pilot valve in vacuum pump system, supply air to PD port (or PS port).

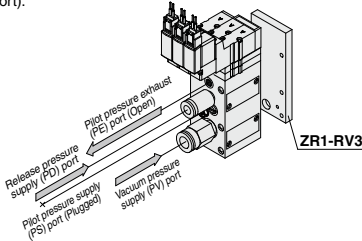

Pipe connection

Example of circuit diagram

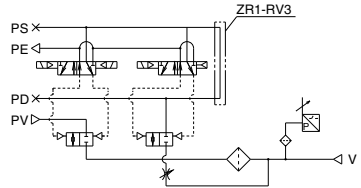

How to Order Function Plate Unit (For Pump System)

ZR1 - RV 3

Piping specifications

Symbol	Symbol	PV port	PS/PD port
3	PV/PS ↔ PD	Individual	Common

How to order

Indicate the model numbers of the vacuum module and the function plate.

Example) ZR100-K15MZ-E 1
* ZR1-RV3 1

⚠ Caution

Length of assembling mounting threads varies when adding function plate later.
Order from the mounting thread parts list for unit combination on page 1019.
Order a plug (ZXI-MP1) separately in order to plug the PD and PS ports that are no longer used due to the addition of function plate.

- ZK2
- ZQ
- ZR**
- ZA
- ZX
- ZM
- ZMA
- ZL
- ZH
- ZU
- ZYY
- ZYX

Valve Unit : ZR1-V□□□□□-□-□



Specifications

Valve unit part no.	ZR1-V□□□□□-□-□	
Components	Supply valve	Release valve
Operating method	Pilot operated	Pilot operated
Combination of supply valve and release valve	Refer to the combination of supply valve and release valve below.	
PV port supply pressure	-0.1 to 0.6 MPa	
PD port supply pressure	0.05 to 0.6 MPa	
PS port supply pressure	0.25 to 0.6 MPa	
Main valve effective area (mm²)	8.2	0.96
Main valve effective area (Cv)	0.45	0.053
Maximum operating frequency	5 Hz	
Operating temperature range	5 to 50°C	
Standard	Bracket B(ZR1-0BB)	

Solenoid Valve/Specifications

Solenoid	SYJ3133-□□□□, SYJ3233-□□□□-X126, SYJ3233-□□□□-X127
Rated voltage	24, 12, 6, 5, 3 VDC, 100 [*] , 110 [*] VAC (60/50 Hz)
Electrical entry	VDC-L/M plug connector, Grommet
Light/Surge voltage suppressor	Available, Not available (at grommet)
Manual operation	Non-locking push type, Locking slotted type

Combination of Supply Valve and Release Valve

Combination symbol	Vacuum switch valve	Release valve	Weight (kg)
K1	Double SOL. (SYJ3233-X126)	N.C. (SYJ3133)	0.34
K2	N.C. (SYJ3133)	N.C. (SYJ3133)	0.27
K3	Air operated (SYJA3130)	Air operated (SYJA3130)	0.194
C1	N.C. (SYJ3133)		0.22
C2	Air operated SYJA3130		0.174
C3	N.C. (SYJ3133)		0.21
C4	Double SOL. (SYJ3233-X127)		0.27

* Weight includes Bracket B. (Solenoid valve: 24 VDC, M plug connector type)

How to Order / Refer to page 1004 for further part no. information.

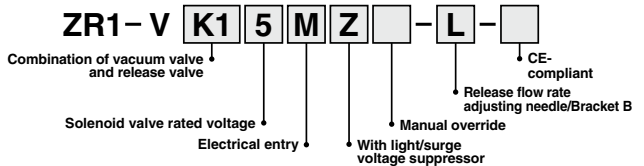

Vacuum Pressure Switch Unit/Digital Pressure Switch for Vacuum : ZR1-ZSE30A-00-□-□□



Specifications

Rated pressure range	0.0 to -101.0 kPa
Set pressure range	10.0 to -105.0 kPa
Withstand pressure	500 kPa
Applicable fluid	Air, Non-corrosive gas, Non-flammable gas
Power supply voltage	12 to 24 VDC ±10% (with power supply polarity protection)
Current consumption	40 mA (at no load)
Switch output	NPN or PNP open collector 1 output NPN or PNP open collector 2 outputs (selectable)
Hysteresis mode	Variable (0 to variable)
Window comparator mode	
Display	4-digit, 7-segment, 2-color LCD (Red/Green) Sampling cycle: 5 times/sec.
Display accuracy	±2% F.S. ±1 digit (Ambient temperature of 25°C)
Enclosure	IP40
Operating temperature range	Operating: 0 to 50°C, Stored: -10 to 60°C (No freezing or condensation)
Operating humidity range	Operating/Stored: 35 to 85% RH (No condensation)
Withstand voltage	1000 VAC for 1 minute between terminals and housing
Temperature characteristics	±2% F.S. (Based on 25°C)

Note 1) When analog voltage output is selected, analog current output cannot be used together.

Note 2) When analog current output is selected, analog voltage output cannot be used together.

Refer to page 988 for further specifications.

Vacuum Pressure Switch : ZSE2-0R-□□

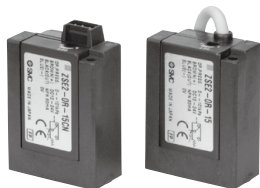

Refer to page 985 for further specifications.

Specifications

Pressure switch for vacuum part no.	ZSE2-0R-15□	ZSE2-0R-55□
Fluid	Air	
Rated pressure range/Set pressure range	0 to -101 kPa	
Proof pressure	500 kPa	
Hysteresis	3% F.S. or less (Fixed)	
Temperature characteristics (Based on 25°C)	± 3% F.S. or less	
Operating voltage	12 to 24 VDC (Ripple ±10% or less)	
Output	NPN Open collector 30 V, 80 mA	PNP Open collector 80 mA
Indicator light	Lights up when ON	
Current consumption	17 mA or less (when 24 VDC is ON)	
Proof pressure (Max. operating pressure)	0.5 MPa*	
Operating temperature range	5 to 50°C	

* When using the ejector system, instantaneous pressure up to 0.5 MPa will not damage the switch.

Note) Operation outside of the maximum operating pressure and operating temperature range may cause a serious accident or damage.

ZK2

ZQ

ZR

ZA

ZX

ZM

ZMA

ZL

ZH

ZU

ZYY

ZYX

Pressure Switch for Vacuum/Suction Filter Unit : ZR1-F□□□□-□

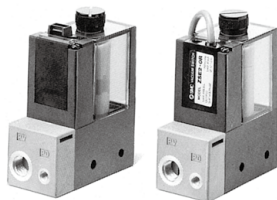

Refer to page 989 for further specifications.

Specifications

Unit no.		ZR1-F□□□□-□
Suction filter	Rated pressure range/Set pressure range	-100 to 0.5 MPa
	Operating temperature range	5 to 50°C
	Filtration degree	30 μm
Filtration material		PVF
Pressure switch for vacuum		Refer to pages 985 and 988 regarding pressure switch for vacuum.
Standard option		Bracket A (ZR1-OBA)

Note) Operation outside of the operating pressure and operating temperature range may cause a serious accident or damage.

Filter case

⚠ Caution

- The case is made of polycarbonate. Therefore, do not use it with or expose it to the following chemicals: paint thinner, carbon tetrachloride, chloroform, acetic ester, aniline, cyclohexane, trichloroethylene, sulfuric acid, lactic acid, watersoluble cutting oil (alkalinic), etc.
- Do not expose it to direct sunlight.

Suction Filter : ZR1-FX-□



Refer to page 991 for further specifications.

Specifications

Model		ZR1-FX-□
Operating pressure range		-0.1 to 0.5 MPa
Operating temperature range		5 to 50°C
Filtration efficiency		30 μm
Filter media		PVF
Weight (with bracket)		0.1 kg
Standard option		Bracket C (ZR1-OBC)

Note) Operation outside of the operating pressure and operating temperature range may cause a serious accident or damage.

Filter case

⚠ Caution

- The case is made of polycarbonate. Therefore, do not contact it or expose it to the following chemicals: paint thinner, carbon tetrachloride, chloroform, acetic ester, aniline, cyclohexane, trichloroethylene, sulfuric acid, lactic acid, watersoluble cutting oil (alkalinic), etc.
- Do not expose it to direct sunlight.

Construction

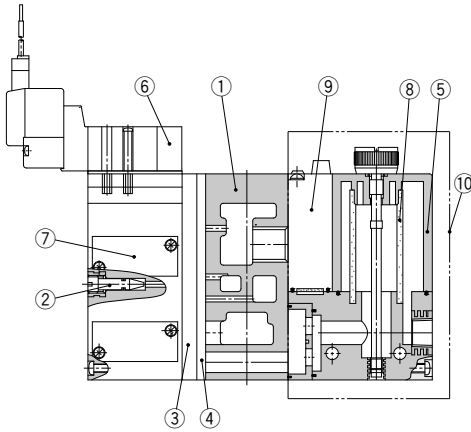

Components Parts

No.	Description	Material	Part model
①	Manifold base	Aluminum alloy	
②	Release flow rate adjusting needle	Stainless steel	Refer to ZR1-NA ^{Note 2)}
③	Function plate	PBT	Refer to page 1014.
④	Individual spacer	PBT	Refer to page 1014.
⑤ ⁽¹⁾	Filter case	Polycarbonate	Refer to page 989.
⑥	Pilot valve assembly	—	Refer to Table (1)
⑦	Valve body assembly	—	Refer to Table (2)
⑧	Filter element	PVF	ZR1-FZ (30 μm)
⑨	Pressure switch for vacuum	—	ZSE2-OR- ¹⁵ / ₃₅ -□
⑩	Filter switch unit for replacement	—	ZR1-F□□□□-D

Note 1) Precautions on handling the filter case

- The case is made of polycarbonate. Therefore, do not contact it or expose it to the following chemicals: paint thinner, carbon tetrachloride, chloroform, acetic ester, aniline, cyclohexane, trichloroethylene, sulfuric acid, lactic acid, water soluble cutting oil (alkaliniic), etc.
- Do not expose it to direct sunlight.

Note 2) Turning the release flow rate adjusting needle 4 full turns from the fully closed position renders the needle valve fully open. Do not turn more than four times since turning excessively may cause the needle fall off. In order to prevent the needle from loosening and falling out, a release flow rate adjusting needle (ZR1-ND-L) with lock nut is available.

Table (1) How to Order Pilot Valves

Symbol	Components		Model
	Supply valve	Release valve	
K1	Double solenoid valve N.C. (SYJ3233)	Single solenoid valve N.C. (SYJ1313)	Refer to "How to Order" below. Supply:ZR1-SYJ3233-□□□□-X126 Release:ZR1-SYJ1313-□□□□
	Double solenoid valve N.O. (SYJ3233)	Double solenoid valve N.O. (SYJ3233)	Refer to "How to Order" below. Supply:ZR1-SYJ3233-□□□□-X127 Release:ZR1-SYJ3233-□□□□-X127
K3	Air operated N.C. (SYJA3130)	Air operated N.O. (SYJA3130)	SYJA3130

Table (2) How to Order Valve Body Assembly

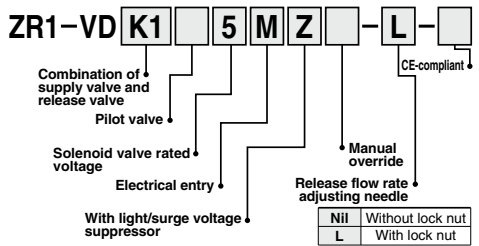

Refer to page 1004 for further symbol specifications.

Table (3) Pressure Switch for Vacuum + Suction Filter Unit

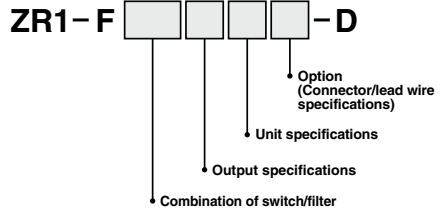

Refer to page 989 for further symbol specifications.

How to Order Solenoid Valves/Air Operated Valves

Air operated

SYJA3130

Solenoid valve

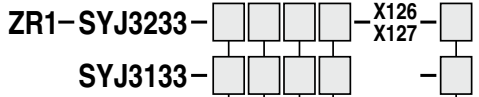

	rated voltage
5	24 VDC
6	12 VDC
V	6 VDC
S	5 VDC
R	3 VDC
1	100 VAC (50/60Hz)
3	110 VAC (50/60Hz)

CE-compliant	
Nil	Standard
Q	CE-compliant (DC only)

Manual override	
Nil	Non-locking push type
D	Slotted locking type

Electrical entry		Light/Surge voltage suppressor
L	L plug connector type	
LN		Without connector
LO		
M	M plug connector type	Lead wire: 0.3 m
MN		Without lead wires
MO		Without connector
G		Lead wire: 0.3 m
H	Grommet type	Lead wire: 0.6 m

Light/Surge voltage suppressor	
Nil	None
Z	With light and surge voltage suppressor
S	With surge voltage suppressor (DC only)

Note) Pilot valve gasket is included.

Large Size Vacuum Module: Vacuum Pump System **Series ZR**

Complete U

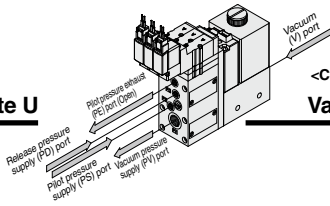

Circuit diagram

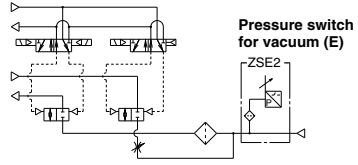

Type K1
Vacuum valve: Double SOL.
Release valve: Single SOL. (N.C.)
ZR100-K1 M - E -

A: Release flow adjusting needle with lock nut

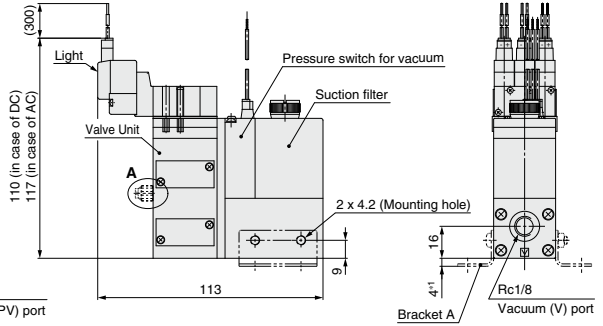
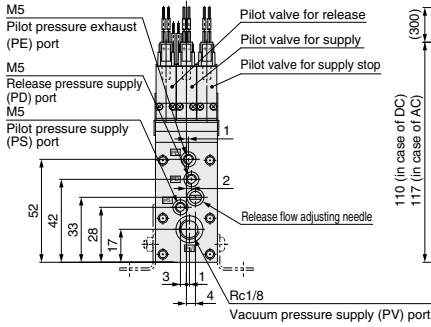
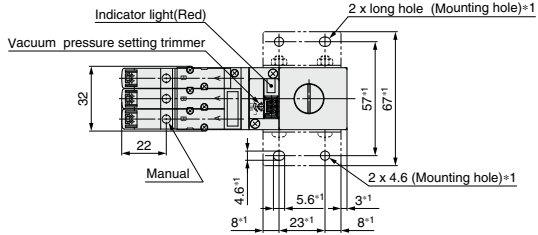
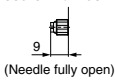

ZR100-K1 M - D -

A: Release flow adjusting needle with lock nut

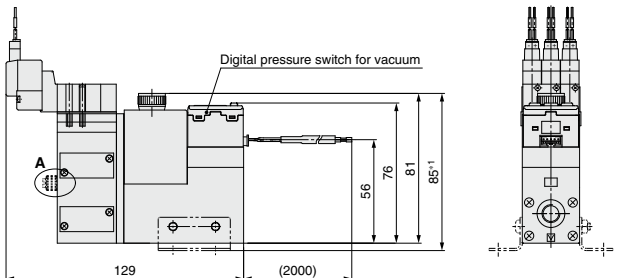
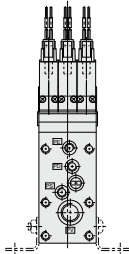
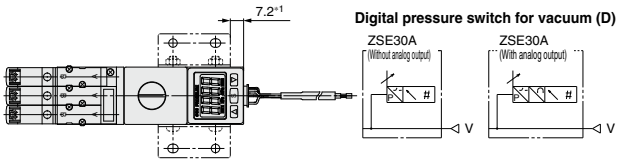
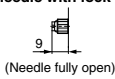

Note) * 1 Dimensions for mounting bracket A
 Bracket A part no.: ZR1-OBA (Standard accessory)

- ZK2
- ZQ
- ZR**
- ZA
- ZX
- ZM
- ZMA
- ZL
- ZH
- ZU
- ZYY
- ZYX

Series ZR

Vacuum Pump System

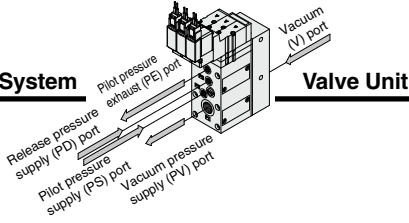

Type K1

ZR1-VK1□M□□-□

Circuit diagram

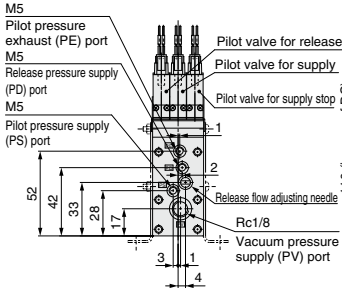
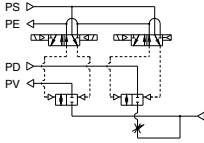

A: Release flow adjusting needle with lock nut

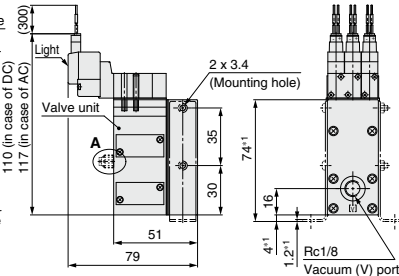
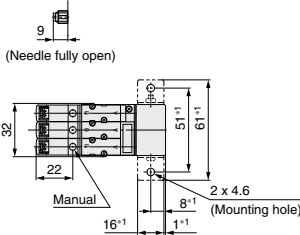

Type K2

ZR1-VK2□M□□-□

Circuit diagram

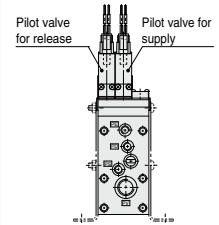
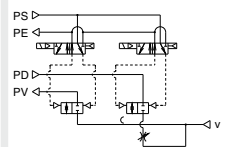

Type K3

ZR1-VK3-□

Circuit diagram

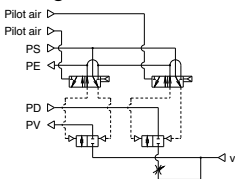

A: Release flow adjusting needle with lock nut

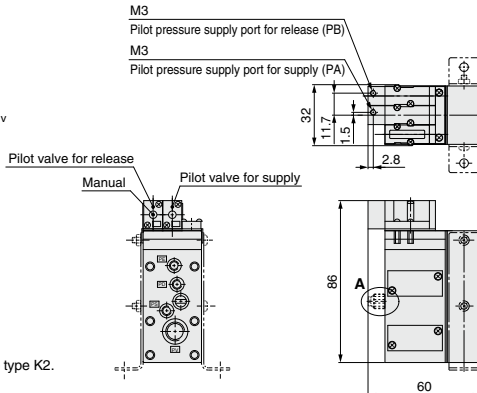
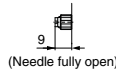

Note) * 1 Dimensions for mounting bracket B
Bracket B part no.: ZR1-0BB
(Standard accessory)

★ Dimensions not indicated are identical to type K2.

Vacuum Pump System

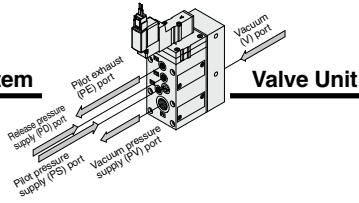

Type C1

ZR1-VC1 □ M □ □ □ □

Circuit diagram

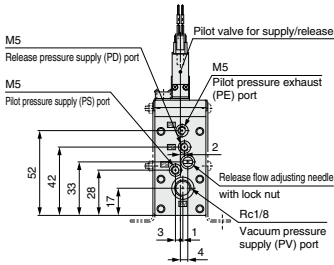
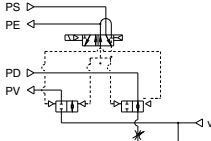

A: Release flow adjusting needle with lock nut

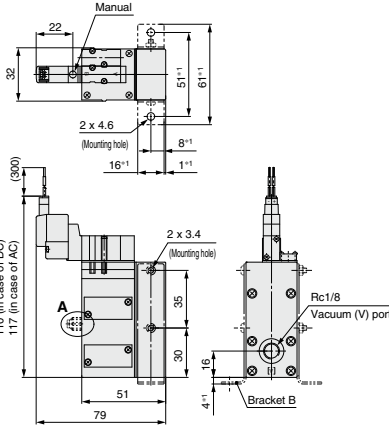
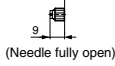

Note) Dimensions *: For mounting bracket B
Bracket B part number: ZR1-0BB
(Standard accessory)

Type C2

ZR1-VC2 □

Circuit diagram

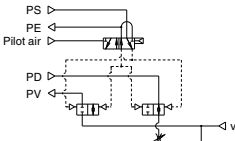

A: Release flow adjusting needle with lock nut

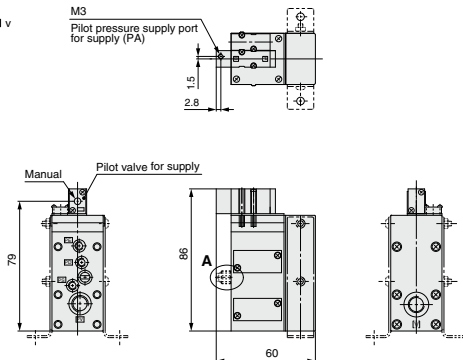

Type C3

ZR1-VC3 □ M □ □ □ □

Circuit diagram

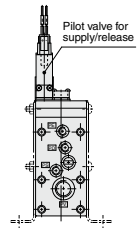
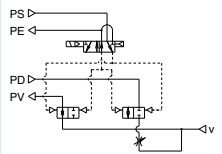

Type C4

ZR1-VC4 □ M □ □ □ □

Circuit diagram

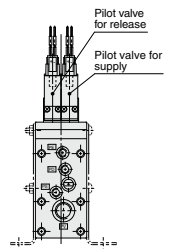
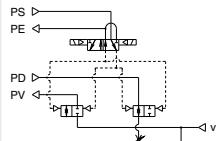

- ZK2
- ZQ
- ZR
- ZA
- ZX
- ZM
- ZMA
- ZL
- ZH
- ZU
- ZYY
- ZYX

★ Dimensions not indicated are identical to drawings above.

Manifold Specifications/Vacuum Pump System



Specifications

Max. number of units	6 stations
Port	Port size
Common vacuum pressure supply (PV) port	1/8 (Rc, NPTF, G)
Common pilot pressure supply (PS) port	M5
Common release pressure supply (PD) port	M5
Common exhaust (EXH) port	1/2 (Rc, NPTF, G)
Weight (Manifold bases only)	Basic mass for one station is 0.28kg. Additional mass per one station is 0.12 kg.

Note) When using 3 or more stations with ZR100 manifold, utilize PV port as suction on both sides.

Manifold Vacuum/Air Supply

Supply port location	Left			Right		
	PV	PS	PD	PV	PS	PD
L (Left side)	○	○	○	●	●	●
R (Right side)	●	●	●	○	○	○
B (Both sides)	○	○	○	○	○	○

Vacuum supply to ○ PV port.

Air supply to ○ port.

BLANK plug attached to ● port.

Note) BLANK plug is attached on all ports of valve unit.

Individual Spacer

Part no.	Port	Function
ZR1-R1 to R16	PV	Possible to set the external vacuum pressure individually
	PS	Possible to set the pilot valve air supply pressure individually
	PD	Possible to set the release valve supply pressure individually
	PE	Possible to set the pilot valve exhaust individually

Individual spacer is used when the connecting port of each unit is not common for the manifold connecting port. Mixed specifications of common and individual unit connecting ports for each unit is possible on manifolds with this individual spacer.

How to Order Manifold

<Manifold base>

ZZR1 06 - [] []

Stations	1
01	1
⋮	⋮
06	6

Port location	R Right side
L	Left side
B	Both sides

Thread type	
Nil	Rc
F	G (Note)
T	NPTF

* Viewed from the front side of valve unit, confirm the port location on the right and/or left side.

Note) The thread ridge shape is compatible with the G thread standard (JIS B 0202), but other shapes are not conforming to ISO16030 and ISO1179.

Example 1)

- ZZR106-R 1 pc. (Manifold base only)
- *ZR100-K15MZ-EC 5 pcs. (Unit)
- *ZR1-BM1 1 pc. (Blank plate)
- *ZR1-R1-3 1 pc. (Individual spacer)

● With reference from valve side, the third station from right side

⚠ Caution when ordering manifold

The asterisk denotes the symbol for assembly. Prefix it to the ejector part numbers to be mounted.

When it is not added, the manifold base and ejector are shipped separately.

<Function plate>

ZR1 - RV3 - 1

Arrangement (Right valve station which is looked from valve side is first station.)

1	1 station only
⋮	⋮
6	6 stations only
A	All stations

* When the spacers are attached to the specified locations, specify all spacers.

Example 2) Attached to the first and third stations

- *ZR1-RV3-1
- *ZR1-RV3-3

Example 3) Attached to all stations.

- *ZR1-RV3-A...2

Fill the number

<Individual spacer>

ZR1 - R1 - 1

R16

Refer to (About individual spacer.)

Arrangement (Right valve station which is looked from valve side is first station.)

1	1 station only
⋮	⋮
6	6 stations only
A	All stations

* When the spacers are attached to the specified locations, specify all spacers.

Example 4) Attached to the first and third stations

- *ZR1-R1-1
- *ZR1-R1-3

<Blanking plate>

ZR1 - BM1

Refer to Example 1).

About individual spacers

- Manifold supply or valve unit supply can be selectable for each port. In the right table, ports with the symbol \uparrow mean that they are manifold supply, while others are individual supply from the valve unit.
- Symbols in the right table are printed on the surface of individual spacers.

Part no.	Symbol	Part no.	Symbol
ZR1-R1	R1	ZR1-R9	R9 \uparrow PV
-R2	R2 \uparrow PE	-R10	R10 \uparrow PV \uparrow PE
-R3	R3 \uparrow PD	-R11	R11 \uparrow PV \uparrow PD
-R4	R4 \uparrow PS \uparrow PD \uparrow PE	-R12	R12 \uparrow PV \uparrow PD \uparrow PE
-R5	R5 \uparrow PS	-R13	R13 \uparrow PV \uparrow PS
-R6	R6 \uparrow PS \uparrow PE	-R14	R14 \uparrow PV \uparrow PS \uparrow PE
-R7	R7 \uparrow PS \uparrow PD	-R15	R15 \uparrow PV \uparrow PS \uparrow PD
-R8	R8 \uparrow PS \uparrow PD \uparrow PE	-R16	R16 \uparrow PV \uparrow PS \uparrow PD \uparrow PE

Manifold/System Circuit Example

When not using individual spacer

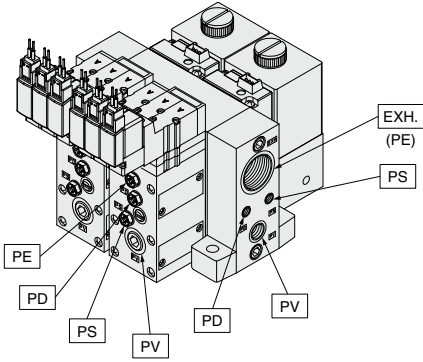

PV: Vacuum pressure supply port
PS: Pilot pressure supply port
PD: Release pressure supply port
PE: Pilot pressure exhaust port
EXH.: Common exhaust port
V: Vacuum Port

When using individual spacer

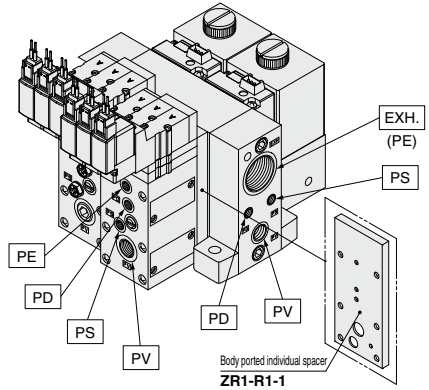

PV: Vacuum pressure supply port
PS: Pilot pressure supply port
PD: Release pressure supply port
PE: Pilot pressure exhaust port
EXH.: Common exhaust port
V: Vacuum Port

ZK2
ZQ
ZR
ZA
ZX
ZM
ZMA
ZL
ZH
ZU
ZYY
ZYX

<System circuit example>

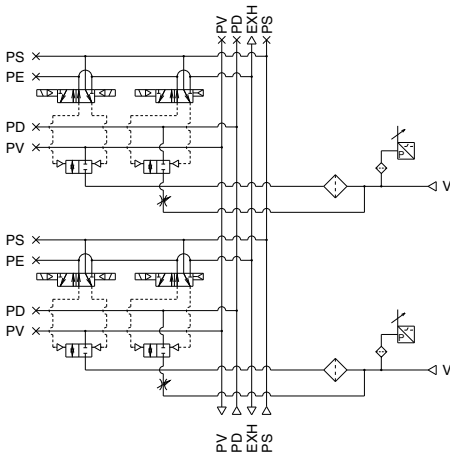

<System circuit example>

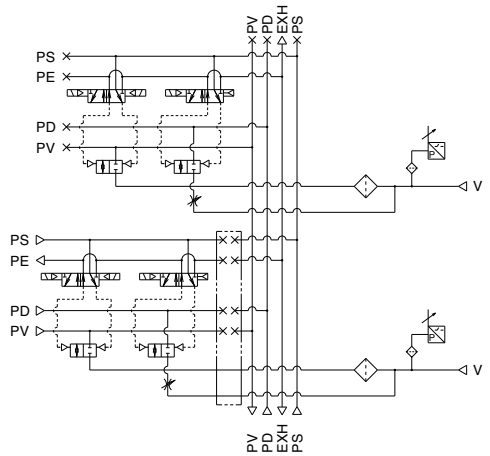

Series ZR

Vacuum Pump System

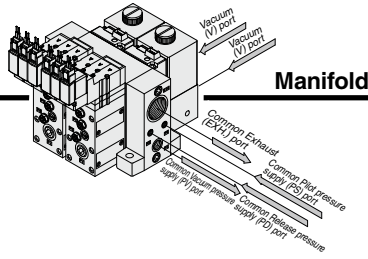

Manifold

A: Release flow adjusting needle with lock nut

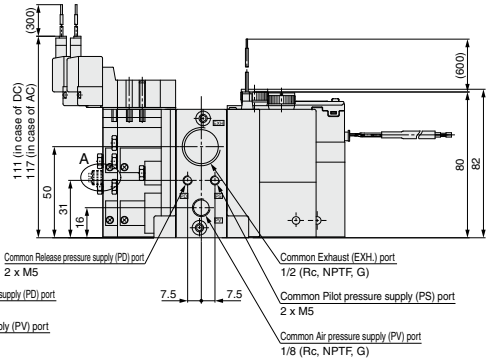
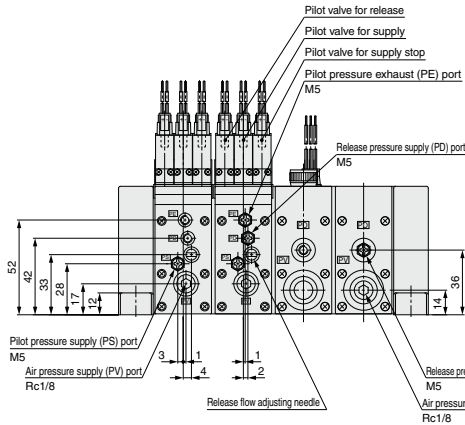
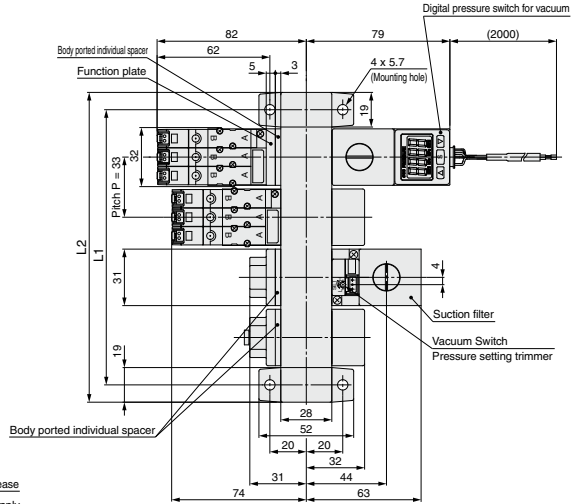
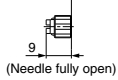

* 1 The common exhaust (EXH) port is also used as the pilot pressure exhaust (PE) port of the pilot valve. Use while the port is open to the atmosphere.

		(mm)					
Symbol	Stations	1	2	3	4	5	6
L1		52	85	118	151	184	217
L2		71	104	137	170	203	236

Circuit diagram

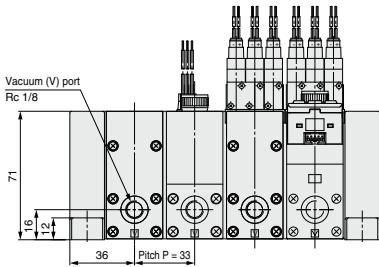
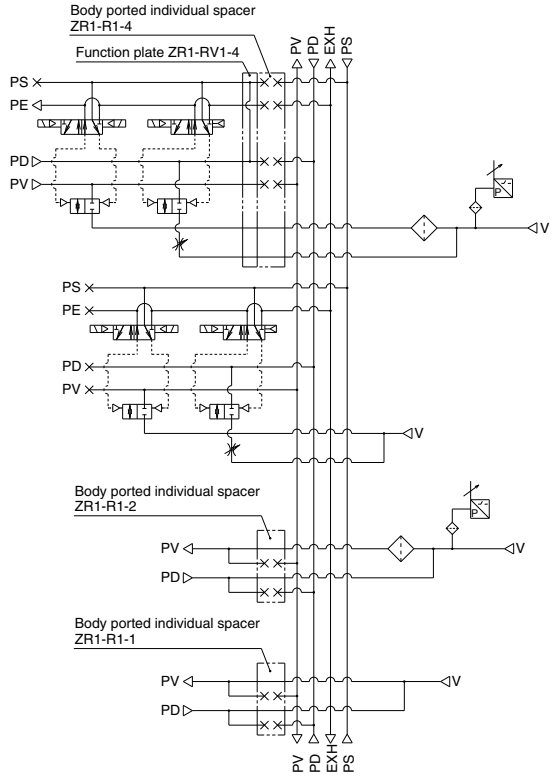

ZK2
ZQ
ZR
ZA
ZX
ZM
ZMA
ZL
ZH
ZU
ZYY
ZYX

- PV : Vacuum pressure supply port
- PS : Common pilot pressure supply port
- PD : Common release pressure supply port
- PE : Pilot valve exhaust port
- EXH : Common exhaust port
- V : Vacuum Port

Ejector System

Mounting Thread Parts List for Unit Combination

Manifold Specifications	Without Manifold
Components Valve unit + Ejector unit + Pressure switch for vacuum/Filter unit	

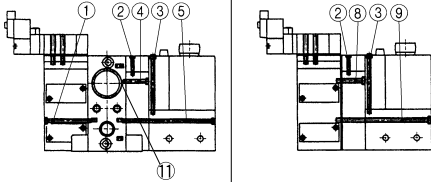

Components	Valve unit + Ejector unit
------------	---------------------------

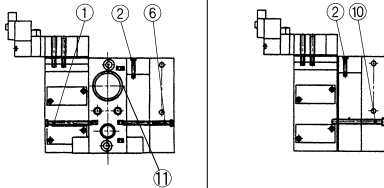

Components	Ejector unit + Pressure switch for vacuum/Filter unit
------------	---

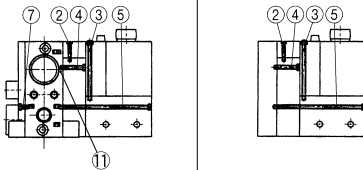

Components	Ejector unit
------------	--------------

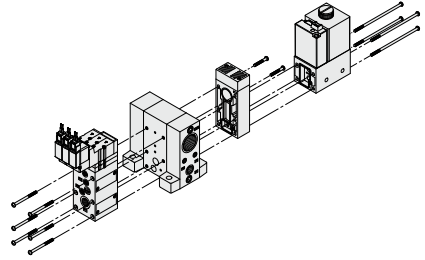
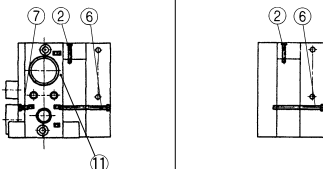

Mounting Thread Parts List for Unit Combination

No.	Combination specifications	Assembly part number
1	Standard (without options)	ZR1-SR2-33-A(a set of six threads)
	With individual spacer	ZR1-SR2-37-A(a set of six threads)
	With function plate	ZR1-SR2-39-A(a set of six threads)
	With individual spacer + with function plate	ZR1-SR2-41-A(a set of six threads)
2	Individual, common and port exhaust style for nozzle size 10, 13	ZR1-SR1-13-A(a set of two threads)
	Common and port exhaust style for nozzle size 18, 20	ZR1-SR1-23-A(a set of two threads)
3	Individual exhaust style for nozzle size 15	ZR1-SR1-48-A(a set of two threads)
	Common and port exhaust style for nozzle size 18, 20	ZR1-SR1-53-A(a set of two threads)
4	For vacuum switch and adapter A	ZR1-SR2-41-1A(a set of two threads)
	For nozzle size 10, 13, 15	ZR1-SR2-17-A(a set of two threads)
5	For nozzle size 18, 20	ZR1-SR2-21-A(a set of two threads)
	For nozzle size 10, 13, 15	ZR1-SR2-66-A(a set of four threads)
	For nozzle size 18, 20	ZR1-SR2-70-A(a set of four threads)
	For nozzle size 10, 13, 15 [For ZSE30A spec.]	ZR1-SR2-82-A(a set of four threads)
6	For nozzle size 18, 20 [For ZSE30A spec.]	ZR1-SR2-86-A(a set of four threads)
	For nozzle size 10, 13, 15	ZR1-SR2-35-A(a set of six threads)
7	For nozzle size 18, 20	ZR1-SR2-39-A(a set of six threads)
	Standard (without options)	ZR1-SR2-5-A(a set of six threads)
8	With individual spacer	ZR1-SR2-5-A(a set of six threads)
	For nozzle size 10, 13, 15	ZR1-SR3-19-1A(a set of two threads)
	For nozzle size 18, 20	ZR1-SR3-23-A(a set of two threads)
	For nozzle size 10, 13, 15 + with function plate	ZR1-SR3-24-1A(a set of two threads)
9	For nozzle size 18, 20 + with function plate	ZR1-SR3-28-A(a set of two threads)
	For nozzle size 10, 13, 15	ZR1-SR3-68-A(a set of four threads)
	For nozzle size 18, 20	ZR1-SR3-72-A(a set of four threads)
	For nozzle size 10, 13, 15 + with function plate	ZR1-SR3-73-A(a set of four threads)
	For nozzle size 18, 20 + with function plate	ZR1-SR3-77-A(a set of four threads)
	For nozzle size 10, 13, 15 [For ZSE30A spec.]	ZR1-SR3-84-A(a set of four threads)
	For nozzle size 18, 20 [For ZSE30A spec.]	ZR1-SR3-88-A(a set of four threads)
	For nozzle size 10, 13, 15 + with function plate [For ZSE30A spec.]	ZR1-SR3-89-A(a set of four threads)
10	For nozzle size 18, 20 + with function plate [For ZSE30A spec.]	ZR1-SR3-93-A(a set of four threads)
	For nozzle size 10, 13, 15	ZR1-SR3-37-A(a set of six threads)
	For nozzle size 18, 20	ZR1-SR3-41-A(a set of six threads)
	For nozzle size 10, 13, 15 + with function plate	ZR1-SR3-42-A(a set of six threads)
11	For nozzle size 18, 20 + with function plate	ZR1-SR3-46-A(a set of six threads)
	When the ejector is compatible with silencer exhaust or port exhaust	BA00601(M12 x 12)
	When the ejector is compatible with common exhaust	Unnecessary

Note 1) * BA00601 (M12 x 12 screws/Hexagon socket head set screws) in until the head aligns with the manifold base surface.

- * The manifold base not assembled with the unit does not include BA00601. Please order them separately.

Note 2) When the valve unit is assembled from a single unit function to a manifold function, 3 pcs. of ZX1-MP1 for PS, PD, PE ports and 1 pc. of TB00148 for PV port are required.

⚠ Precautions

- Be sure to read before handling.
- Refer to front matter 35 for Safety Instructions and pages 899 to 901 for Vacuum Equipment Precautions.

⚠ Caution

Refer to the Vacuum Equipment Model Selection on page 877 for precautions on matching with vacuum circuit.

Vacuum Pump System

Mounting Thread Parts List for Unit Combination

Manifold Specifications	Without Manifold
-------------------------	------------------

Components	Valve unit + Pressure switch for vacuum / Filter unit
------------	---

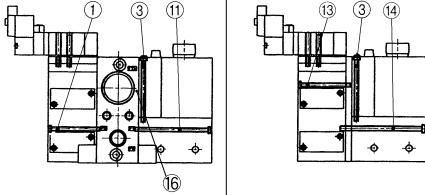

Components	Valve unit
------------	------------

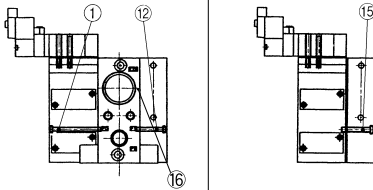

Components	Pressure switch for vacuum / Filter unit
------------	--

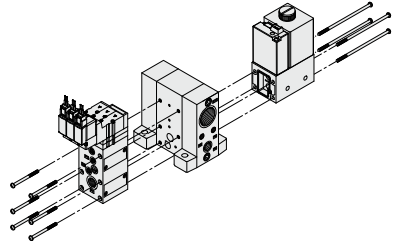
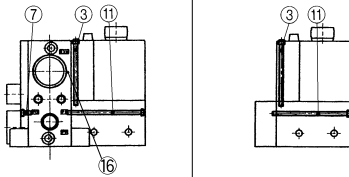

Mounting Thread Parts List for Unit Combination

No.	Combination specifications	Assembly part number
1	Standard (Without options)	ZR1-SR2-33-A(a set of six threads)
	With individual spacer	ZR1-SR2-37-A(a set of six threads)
	With function plate	ZR1-SR2-39-A(a set of six threads)
3	With individual spacer + with function plate	ZR1-SR2-41-A(a set of six threads)
	For vacuum switch and adapter A	ZR1-SR2-41-1A(a set of two threads)
7	Standard (Without options)	ZR1-SR2-5-A(a set of six threads)
	With individual spacer	ZR1-SR2-8-A(a set of six threads)
11	Standard (Without options)	ZR1-SR2-49-A(a set of four threads)
	Standard (Without options) [For ZSE30A spec.]	ZR1-SR2-66-A(a set of four threads)
12	Standard (Without options)	ZR1-SR2-18-A(a set of six threads)
	Standard (Without options)	ZR1-SR2-33-1A(a set of two threads)
13	With function plate	ZR1-SR2-39-1A(a set of two threads)
	Standard (Without options)	ZR1-SR3-54-A(a set of four threads)
	With function plate	ZR1-SR3-59-A(a set of four threads)
14	Standard (Without options) [For ZSE30A spec.]	ZR1-SR3-70-A(a set of four threads)
	With function plate [For ZSE30A spec.]	ZR1-SR3-75-A(a set of four threads)
	Standard (Without options)	ZR1-SR3-19-A(a set of six threads)
15	With function plate	ZR1-SR3-24-A(a set of six threads)
	Standard	BA00601(M12 x 12)
16 ^{Note 1)}	Standard	BA00601(M12 x 12)

Note 1) • BA00601 (M12 x 12 screws/Hexagon socket head set screws) in unit
the head aligns with the manifold base surface.

• The manifold base not assembled with the unit does not include BA00601. Please order them separately.

Note 2) When the valve unit is assembled from a single unit function to a manifold function, 3 pcs. of ZX1-MP1 for PS, PD, PE ports and 1 pc. of TB00148 for PV port are required.

ZK2

ZQ

ZR

ZA

ZX

ZM

ZMA

ZL

ZH

ZU

ZYY

ZYX