

# Trimmer Auto Switch

## D-M9K/D-□7K/D-R□K Series

One auto switch allows work pieces to be distinguished easily.



Minimum adjustment width to detect

**0.5 mm**

With one switch, various sized work pieces can be detected by the difference of 0.5 mm or more.  
\* From 0.5 mm to detectable width dependant on applied actuator.

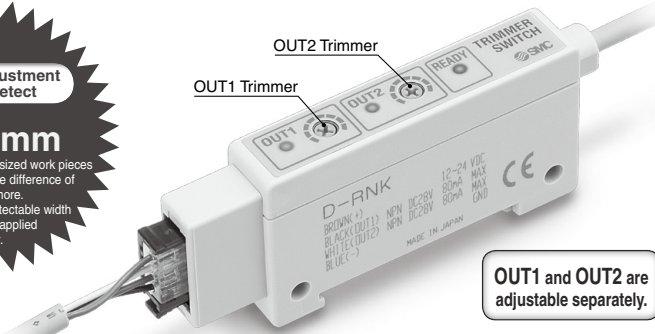

OUT1 and OUT2 are adjustable separately.

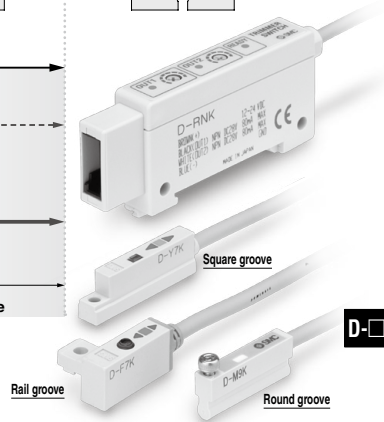
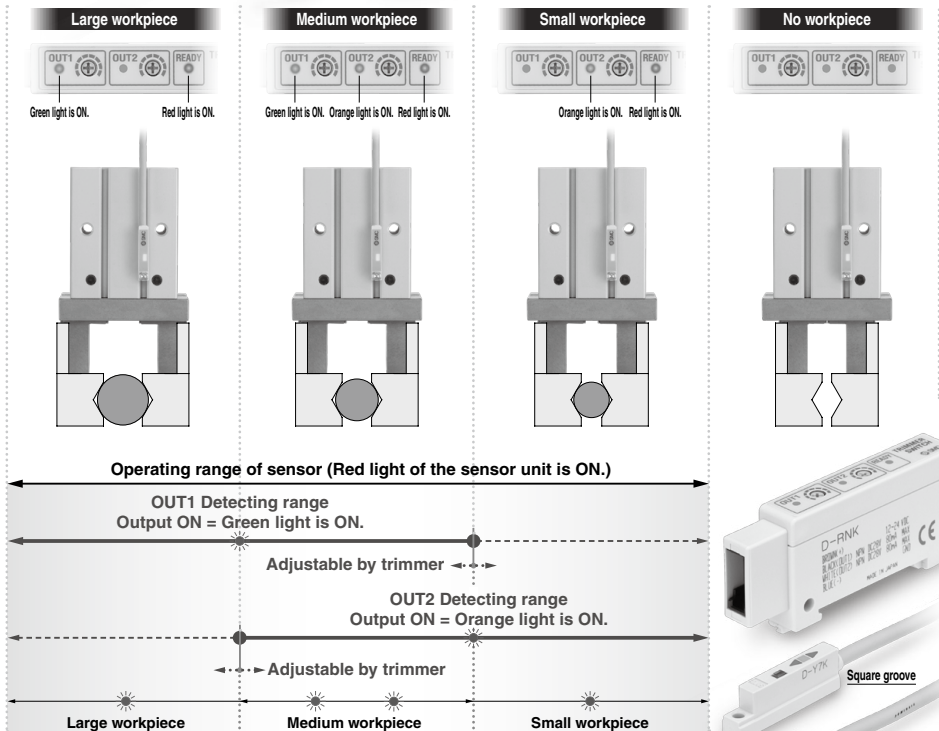

## Applicable to the short stroke cylinder.

Only one auto switch can detect the extended and retracted end positions.  
This switch can be used when two auto switches cannot be mounted due to short stroke.

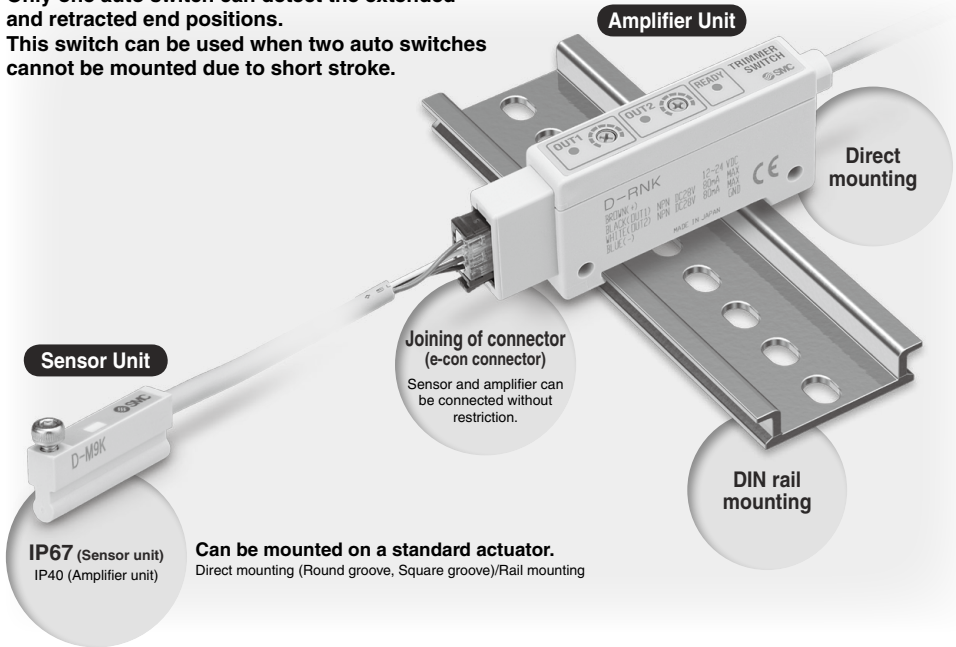

IP67 (Sensor unit)  
IP40 (Amplifier unit)

Can be mounted on a standard actuator.  
Direct mounting (Round groove, Square groove)/Rail mounting

### Examples

#### For checking height of a workpiece

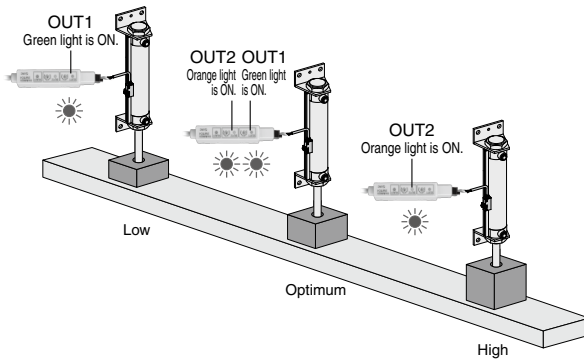

#### For checking depth of the machined hole

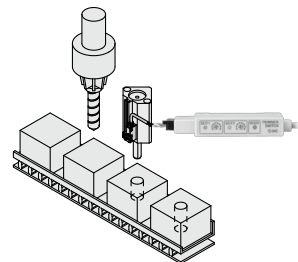

# Trimmer Auto Switch



# D-M9K/D-□7K/D-R□K Series

Direct mounting  
(Round groove)

Direct mounting  
(Square groove)

Rail mounting

## Specifications

### Sensor Unit

Auto switch model	D-M9K	D-Y7K	D-F7K
<b>Mounting</b>	Direct mounting (Round groove)	Direct mounting (Square groove)	Rail mounting
<b>Applicable amplifier unit</b>	D-RNK, D-RPK		
<b>Indicator lamp</b>	Red lights ON at sensitive position. Green lights ON at optimum detecting position.		
<b>Electrical entry</b>	Grommet		
<b>Impact resistance</b>	980 m/s <sup>2</sup>		
<b>Insulation resistance</b>	50 MΩ or more (500 VDC measured via megohmmeter) between lead wire and case		
<b>Withstand voltage</b>	1000 VAC for 1 minute (between lead wire and case)		
<b>Ambient temperature</b>	-10 to 60°C		
<b>Enclosure</b>	IP67		
<b>Weight (with connector)</b>	55 g		58 g
<b>Standard</b>	CE Marking		

### Oilproof Heavy-duty Cable

Auto switch model	D-M9K	D-Y7K	D-F7K
<b>Sheath</b>	Outside diameter [mm]	ø3.5	
<b>Insulator</b>	Number of cores	4 cores (Brown/Blue/Black/White)	
	Outside diameter [mm]	ø1.0	
<b>Conductor</b>	Effective area [mm <sup>2</sup> ]	0.15 (AWG26)	
	Strand diameter [mm]	ø0.08	
Minimum bending radius [mm] (Reference value)		21	

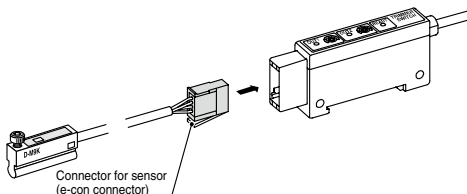

Note) The connector for sensor (e-con connector) is not attached to the lead wire. It will be supplied loose in the same shipment (1 pc.).

## Internal Circuit

### Sensor Unit

#### D-M9K/D-□7K

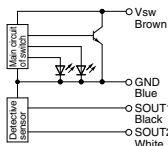

### Amplifier Unit

#### D-RNK

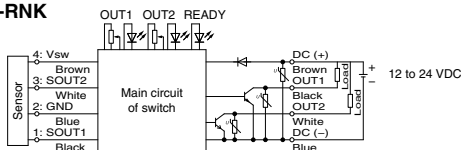

#### D-RPK

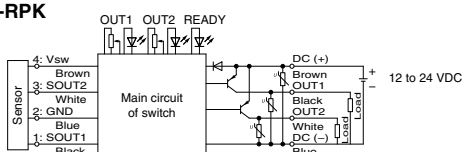

### Amplifier Unit (with Sensor Unit) PLC: Programmable Logic Controller

Model	D-RNK	D-RPK
<b>Applicable sensor unit</b>	D-M9K, D-Y7K, D-F7K	
<b>Application</b>	For relay and PLC	
<b>Power supply voltage</b>	12 to 24 VDC	
<b>Current consumption</b>	40 mA or less	
<b>Output specification</b>	NPN open collector 2 outputs	PNP open collector 2 outputs
<b>Load voltage</b>	28 VDC or less	—
<b>Load current</b>	80 mA or less/1 output	
<b>Internal voltage drop</b>	1.5 V or less	
<b>Leakage current</b>	100 μA or less/1 output	
<b>Response time</b>	1 ms or less	
<b>Indicator lamp</b>	READY: Red lights ON when the piston position detected (with sensor unit). OUT1: Green lights ON when turned ON. OUT2: Orange lights ON when turned ON.	
<b>Electrical entry</b>	Connection to sensor	e-con connector
<b>Power supply/output cable</b>	Grommet	
<b>Impact resistance</b>	98 m/s <sup>2</sup>	
<b>Insulation resistance</b>	50 MΩ or more (500 VDC measured via megohmmeter) between lead wire and case	
<b>Withstand voltage</b>	1000 VAC for 1 minute (between lead wire and case)	
<b>Ambient temperature</b>	-10 to 60°C	
<b>Enclosure</b>	IP40	
<b>Weight</b>	70 g	
<b>Standard</b>	CE Marking	

### Oilproof Heavy-duty Cable

Model	D-RNK	D-RPK
<b>Sheath</b>	Outside diameter [mm]	ø3.5
<b>Insulator</b>	Number of cores	4 cores (Brown/Blue/Black/White)
	Outside diameter [mm]	ø1.0
<b>Conductor</b>	Effective area [mm <sup>2</sup> ]	0.15 (AWG26)
	Strand diameter [mm]	ø0.08
Minimum bending radius [mm] (Reference value)		21

# D-M9K/D-□7K/D-R□K Series

Values which include hysteresis are for guideline purposes only, they are not a guarantee (assuming approximately ±30% dispersion) and may change substantially depending on the ambient environment. Please consult with SMC for alternative actuators other than those shown below.

## Applicable Actuators and Operating Range (Angle)

### Sensor Unit D-M9K



**Air Grippers** (The operating range for grippers is measured when both ends are open.)

Description/Series		Bore size										
		10	16	20	25	32	40	50	63	80	100	125
Parallel type	MHZ2	—	3.5	5.5	6.0	7.5	8.0	—	—	—	—	—
Parallel type	MHZJ2	—	5.0	6.0	6.0	—	—	—	—	—	—	—
Parallel type	MHS2 (2 fingers)	—	—	4.0	4.5	*						
Parallel type	MHS3 (3 fingers)	—	—	4.0	4.5	*						
Parallel type	MHS4 (4 fingers)	—	—	4.0	4.5	*						

\* When using the MHS series (bore size ø32 or more), use the D-Y7K.

### Air Cylinders

Description/Series		Bore size														
		12	16	20	25	32	40	50	63	80	100	125	140	160	180	200
Compact cylinder	CQ2 <sup>1</sup>	3.0	4.0	4.0	4.0	4.5	4.0	4.5	5.0	5.0	6.0	6.5	6.5	6.0	6.0	6.0
Compact cylinder guide rod type	CQM	2.5	3.0	4.0	3.5	4.5	4.0	4.5	5.0	5.0	6.0	—	—	—	—	—
3 position cylinder	RZQ	—	—	—	—	4.5	4.0	4.5	5.0	—	—	—	—	—	—	—
Rotary clamp cylinder	MK	2.5	3.5	3.5	4.0	4.5	4.0	4.5	4.5	—	—	—	—	—	—	—
Compact guide cylinder	MGP-Z	3.0	4.0	4.0	4.0	4.5	4.0	4.0	4.5	4.5	5.0	—	—	—	—	—

\* Excludes the axial piping type (CQP2), compact cylinder with end lock (CBQ2), and the low-speed cylinder (CQ2X)

### Sensor Unit D-Y7K



**Air Grippers** (The operating range for grippers is measured when both ends are open.)

Description/Series		Bore size										
		10	12	16	20	25	32	40	50	63	80	100
Parallel type	MHZ2	3.0	—	5.0	7.0	7.0	8.0	8.0	8.5	—	—	—
Parallel type	MHZL2	6.0	—	7.0	10.0	11.0	—	—	—	—	—	—
Wide type	MHL2	7.0	—	8.0	8.5	10.5	11.0	12.5	—	—	—	—
Parallel type	MHS2 (2 fingers)	—	—	—	—	—	—	6.5	7.0	7.5	8.5	—
Parallel type	MHS3 (3 fingers)/MHS(L)3	—	—	—	—	—	—	6.5	7.0	7.5	8.0	—
Parallel type	MHS4 (4 fingers)	—	—	—	—	—	—	6.5	7.0	7.5	8.5	—
Angular type	MHC2	30° to -10°	—	30° to -10°	30° to -10°	30° to -10°	22.5° to -10°	—	—	—	—	—
180° Angular type	MHW2	—	—	—	88° to -5°	54° to -6°	58° to -5°	41° to -5°	30° to -4°	—	—	—

### Air Cylinders

Description/Series		Bore size							
		20	25	32	40	50	63	80	100
Compact guide cylinder	MGP <sup>1</sup>	4.5	4.5	5.5	5.5	5.5	5.5	5.5	6.0
Non-rotating double power cylinder	MGZ	—	—	—	5.5	6.5	6.5	—	—
Air cylinder	CA2	—	—	—	4.0	4.0	6.0	6.0	6.0

\* Only the cylinder with end lock (MGP-H/R) and the heavy duty guide rod type (MGPS)

### Sensor Unit D-F7K



**Air Cylinders**

Description/Series		Bore size										
		10	12	16	20	25	32	40	50	63	80	100
Air cylinder	CJ2	4.0	—	4.5	—	—	—	—	—	—	—	—
Air cylinder	CM2 <sup>1</sup>	—	—	—	3.5	3.5	3.5	3.5	—	—	—	—
Compact cylinder	CQ2 <sup>2</sup>	—	4.5	5.5	5.5	5.0	5.5	5.5	5.5	6.0	5.5	6.0
Plate cylinder	MU	—	—	—	—	5.5	6.5	6.5	6.5	6.5	—	—
Rotary clamp cylinder	MK2T	—	—	—	5.0	5.0	6.5	6.0	6.0	6.5	—	—

<sup>1</sup>1 Use the Made-to-Order product (-XG13: Auto switch rail mounting type) for the CM2 series.

<sup>2</sup>2 The axial piping type (CQP2), compact cylinder with end lock (CBQ2), and the low-speed cylinder (CQ2X) are not applicable.

# Trimmer Auto Switch **D-M9K/D-□7K/D-R□K Series**

## Dimensions

### Sensor Unit

#### D-M9K

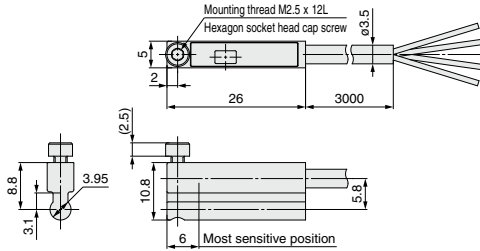

#### D-Y7K

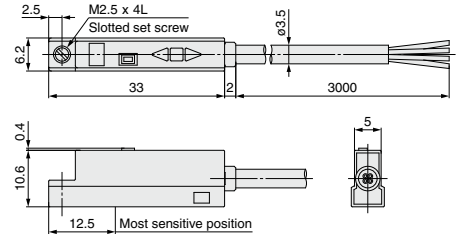

#### D-F7K

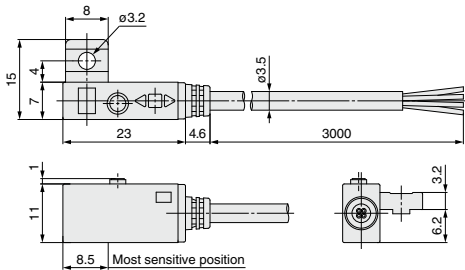

### Amplifier Unit

#### D-R□K

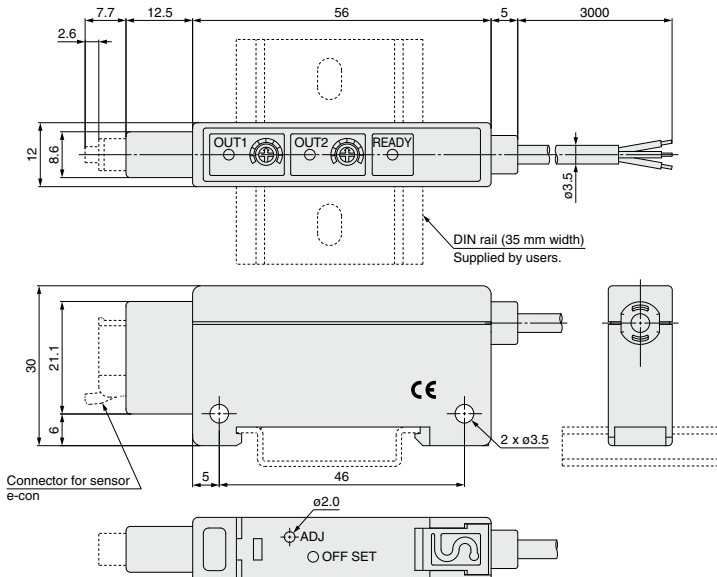

# D-M9K/D-□7K/D-R□K Series

## How to Mount and Move the Auto Switch

### D-M9K **Mounting Bracket** Direct Mounting Type

<Applicable auto switch>

Solid state.....D-M9K

#### Applicable Actuators

##### Air Grippers

Description	Series	Bore size
Parallel type	MHZ2	16 to 40
Parallel type	MHZJ2	16 to 25
Parallel type	MHS2 (2 fingers)	20, 25
Parallel type	MHS3 (3 fingers)	20, 25
Parallel type	MHS4 (4 fingers)	20, 25

##### Air Cylinders

Description	Series	Bore size
Compact cylinder	CQ2*	12 to 200
Compact cylinder guide rod type	CQM	12 to 100
3 position cylinder	RZQ	32 to 63
Rotary clamp cylinder	MK	12 to 63
Compact guide cylinder	MGP-Z	12 to 100

\* Excludes the axial piping type (CQP2), compact cylinder with end lock (CBQ2), and the low-speed cylinder (CQ2X)

### How to Mount and Move the Auto Switch

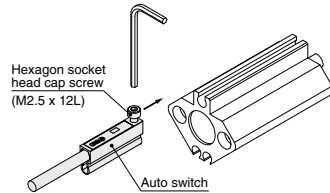

Note) The tightening torque for a hexagon socket head cap screw (M2.5 x 12L) is 0.1 to 0.2 N·m.

### D-Y7K **Mounting Bracket** Direct Mounting Type

<Applicable auto switch>

Solid state.....D-Y7K

#### Applicable Actuators

##### Air Grippers

Description	Series	Bore size
Parallel type	MHZ2	10 to 40
Parallel type	MHZL2	10 to 25
Wide type	MHL2	10 to 40
Parallel type	MHS2 (2 fingers)	32 to 63
Parallel type	MHS3 (3 fingers)/MHS(L)3	32 to 63
Parallel type	MHS4 (4 fingers)	32 to 63
Angular type	MHC2	10 to 25
180° Angular type	MHW2	20 to 50

##### Air Cylinders

Description	Series	Bore size
Non-rotating double power cylinder	MGZ	40 to 63
Compact guide cylinder	MGP*	20 to 100

\* Only the cylinder with end lock (MGP-H/R) and the heavy duty guide rod type (MGPS)

### How to Mount and Move the Auto Switch (2)

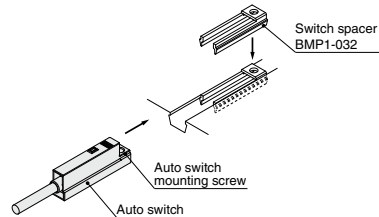

1. After picking up a switch spacer between your fingers, push it in the cylinder tube groove.
2. Confirm that it is set in the correct mounting orientation.

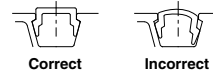

3. Insert the auto switch into the mounting groove and set it at the auto switch mounting position.
4. After reconfirming the detecting position, tighten the mounting screw to secure the auto switch.

Note) When tightening an auto switch mounting screw, use a watchmaker's screwdriver with a grip diameter of 5 to 6 mm. Also, tighten with a torque of about 0.05 to 0.1 N·m  
As a guide, it should be turned about 90° past the point at which tightening can be felt.

#### Auto Switch Mounting Bracket/Part No. (Switch spacer and auto switch mounting bracket)

Cylinder series	Bore size		
	40	50	63
MGZ	BMP1-032	BMP1-032	BMP1-032

### How to Mount and Move the Auto Switch (1)

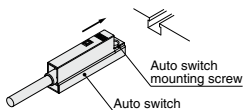

1. Insert the auto switch into the mounting groove and set it at the auto switch mounting position.
2. After reconfirming the detecting position, tighten the mounting screw to secure the auto switch.
3. Modification of the detecting position should be made in the condition of 1.

Note) When tightening an auto switch mounting screw, use a watchmaker's screwdriver with a grip diameter of 5 to 6 mm. Also, tighten with a torque of about 0.05 to 0.1 N·m  
As a guide, it should be turned about 90° past the point at which tightening can be felt.

## How to Mount and Move the Auto Switch

### D-F7K **Mounting Bracket** Rail Mounting Type

<Applicable auto switch>

Solid state..... D-F7K

#### Applicable Actuators

##### Air Cylinders

Description	Series	Bore size
Air cylinder	CJ2	10, 16
Air cylinder	CM2	20 to 40
Compact cylinder	CQ2	12 to 100
Plate cylinder	MU	25 to 63
Rotary clamp cylinder	MK2T	20 to 63

### How to Mount and Move the Auto Switch

- Slide the auto switch mounting nut inserted into the mounting rail and set it at the auto switch mounting position.
- Fit the convex part of auto switch mounting arm into the concave part of auto switch mounting rail. Then, slide the switch over the nut.  
(CDQ2 series: Fit the convex part of auto switch mounting arm through the auto switch spacer into the concave part of auto switch mounting rail.)
- Push the auto switch mounting screw lightly into the mounting nut through the hole of auto switch mounting arm.
- After reconfirming the detecting position, tighten the mounting screw to secure the auto switch. (Tightening torque of M3 screw should be 0.5 to 0.7 N·m.)
- Modification of the detecting position should be made in the condition of 3.

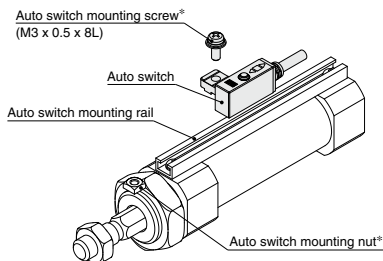

\* When the CJ2 (rail mounting type) and the CM2-XC13 cylinders are ordered, nuts and screws are included.

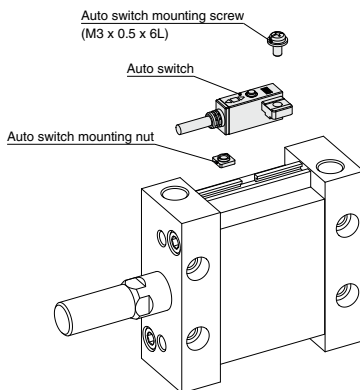

### Auto Switch Mounting Bracket Part No. (Including Nut, Screw, (Spacer))

Cylinder series	Bore size									
	12	16	20	25	32	40	50	63	80	100
<b>CQ2</b> *	BQ-1	BQ-1	BQ-1	BQ-1	BQ-2	BQ-2	BQ-2	BQ-2	BQ-2	BQ-2
<b>MU</b>	—	—	—	BMU1-025	BMU1-025	BMU1-025	BMU1-025	BMU1-025	—	—
<b>MK2T</b>	—	—	BQ-1	BQ-1	BQ-2	BQ-2	BQ-2	BQ-2	—	—

\* Only the axial piping type (CQP2), compact cylinder with end lock (CBQ2), and the low-speed cylinder (CQ2X) can be used.

# D-M9K/D-□7K/D-R□K Series

## How to Mount and Move the Auto Switch

### D-Y7K **Mounting Bracket** Tie-rod Mounting Type

<Applicable auto switch>

Solid state..... D-Y7K

#### Applicable Actuators

##### Air Cylinder

Description	Series	Bore size
Air cylinder	CA2	40 to 100

#### How to Mount and Move the Auto Switch

1. Fix it to the detecting position with a set screw by installing an auto switch mounting bracket in cylinder tie-rod and letting the bottom surface of an auto switch mounting bracket contact the cylinder tube firmly. Fix it to the detecting position with a set screw. (Use a hexagon wrench.)
2. Fit an auto switch into the auto switch mounting groove to set it roughly to the mounting position for an auto switch.
3. After confirming the detecting position, tighten up the mounting screw attached to an auto switch, and secure the auto switch.
4. When changing the detecting position, carry out in the state of 2.

\* To protect auto switches, ensure that main body of an auto switch should be embedded into auto switch mounting groove with a depth of 15 mm or more.

#### Auto Switch Mounting Bracket Part No. (Including Bracket, Set Screw)

Cylinder series	Bore size				
	40	50	63	80	100
CA2	BA4-040	BA4-040	BA4-063	BA4-080	BA4-080

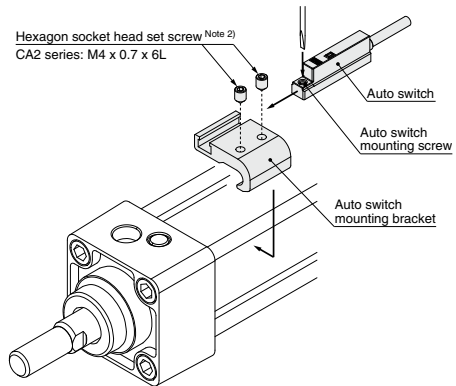

Note 1) When tightening an auto switch mounting screw, use a watchmaker's screwdriver with a grip diameter of 5 to 6 mm. Also, set the tightening torque to be 0.05 to 0.1 N·m. As a guide, turn 90° from the position where it comes to feel tight.

Note 2) Set the tightening torque of a hexagon socket head set screw (M4 x 0.7) to be 1 to 1.2 N·m.





# Trimmer Auto Switch Specific Product Precautions

Be sure to read this before handling the products. Refer to back page 50 for Safety Instructions and pages 8 to 12 for Auto Switch Precautions.

## Design and Selection

### Warning

#### 1. Check the specifications.

Read the specifications carefully and use this product appropriately. The product may be damaged or malfunction if it is used outside the range of specifications of current load, voltage, temperature or impact.

#### 2. Cautions for use in an interlock circuit

When an auto switch is used for an interlock signal requiring high reliability, devise a double interlock system to avoid trouble by providing a mechanical protection function, or by also using another switch (sensor) together with the trimmer auto switch. Also, perform periodic maintenance and confirm proper operation.

### Caution

#### 1. Take precautions when multiple cylinders are used close together.

When 2 or more cylinders with trimmer auto switches are used in close proximity, maintain a minimum actuator interval of 40 mm or more. (When the allowable interval is indicated for each cylinder series, use the specified values.) Magnetic field interference may cause the trimmer auto switches to malfunction.

#### 2. Keep the wiring as short as possible.

Use a wire 3 m or shorter between the sensor and amplifier. If the sensor cable length exceeds 3 m, the CE marking does not apply to the auto switch. Although wire length of power supply/output cable should not affect switch function, use a wire 100 m or shorter.

#### 3. Take precautions for the internal voltage drop of the switch.

Auto switches may not operate properly depending on the connected equipment.

#### 4. Take measures for rotational stoppage of the piston rod.

Take measures for rotational stoppage of the piston rod when designing by guide etc. Or use non-rotating type SMC products. The operation may be unstable.

## Mounting and Adjustment

### Caution

#### 1. Do not drop or bump.

Do not drop, bump or apply excessive impacts (980 m/s<sup>2</sup> or more for sensor unit and 98 m/s<sup>2</sup> or more for amplifier unit) while handling. Although the trimmer auto switch body may not be damaged, the inside of the trimmer auto switch could be damaged and cause a malfunction.

#### 2. Refer to the Operation Manual for how to adjust/set.

## Wiring

### Caution

#### 1. Avoid repeatedly bending or stretching lead wires.

Broken lead wires will result from applying bending stress or stretching forces to the lead wires.

#### 2. Be sure to connect the connector for sensor to the amplifier before power is applied.

#### 3. Do not allow short circuit of loads.

Output is automatically stopped when the protection circuit is working, as the output unit registers any excess current flow, if loads are short circuited. Should this occur, shut off the power supply, remove the cause of this excess current flow and switch on the power again. Take special care to avoid reverse wiring between the power supply line (brown) and the output line (black, white).

## Wiring

### Caution

#### 4. Avoid incorrect wiring.

If the connections are reversed (power supply line + and power supply line -), the trimmer auto switches will be protected by a protection circuit. However, if the power supply line (-) is connected to the black, white wire, the trimmer auto switches will be damaged.

## Operating Environment

### Warning

#### 1. Never use in an atmosphere with explosive gases.

The structure of trimmer auto switches is not designed to prevent explosion. Never use in an atmosphere with an explosive gas since this may cause a serious explosion.

### Caution

#### 1. Do not use in an area where a magnetic field is generated.

Trimmer auto switches will malfunction or magnets inside actuators will become demagnetized.

#### 2. Do not use in an environment where the trimmer auto switch will be continually exposed to water.

Although the sensor units of trimmer auto switches satisfy the IEC standard IP67 structure, do not use trimmer auto switches in applications where continually exposed to water splash or spray. Poor insulation or swelling of the potting resin inside trimmer auto switches may cause a malfunction. (Amplifier unit D-RNK and RPK: IP40)

#### 3. Do not use in an environment with oil or chemicals.

Please consult with SMC if trimmer auto switches will be used in an environment with coolant, cleaning solvent, various oils or chemicals. If trimmer auto switches are used under these conditions for even a short time, they may be adversely affected by improper insulation, malfunction due to swelling of the potting resin, or hardening of the lead wires.

#### 4. Take measures against freezing when operating at 5°C or less.

## Maintenance

### Warning

#### 1. Perform the following maintenance periodically in order to prevent possible danger due to unexpected trimmer auto switch malfunction.

- 1) Secure and tighten trimmer auto switch mounting screws.  
If screws become loose or the mounting position is dislocated, retighten them after readjusting the mounting position.
- 2) Confirm that there is no damage to lead wires.  
To prevent faulty insulation, replace trimmer auto switches or repair lead wires, etc., if damage is discovered.

## Other

### Caution

#### 1. Please consult with SMC concerning water resistance, elasticity of lead wires, and usage at welding sites, etc.

