

Датчик перепада давления

PSE550

Предназначен для контроля перепада давления.

- Аналоговый выходной сигнал 1 ~ 5 В или 4 ~ 20 мА
- Высокая точность и линейность характеристик
- Компактная конструкция
- Встроенный индикатор
- Может использоваться совместно с контроллером PSE300
- Степень защиты IP40

Технические характеристики

Номер для заказа		PSE550	PSE550-28
Диапазон измеряемого перепада давлений (кПа)		0 ~ 2	
Рабочий диапазон давлений (кПа)		-50 ~ 50	
Испытательное давление (кПа)		65	
Рабочая среда		Сжатый воздух, некоррозионные газы	
Напряжение питания		12 ~ 24 VDC (колебания напряжения ±10%)	
Потребление тока (мА)		≤ 15	-
Аналоговый выход		1 ~ 5 В, выходное сопротивление 1 кОм	4 ~ 20 мА, макс. сопротивление нагрузки 100 Ом (при 12 VDC) и 500 Ом (при 24 VDC)
Погрешность измерений		≤ ± 1% (от полного диапазона при температуре +25±3°C)	
Линейность		≤ ± 0.5% (от полного диапазона)	
Воспроизводимость		≤ ± 0.3% (от полного диапазона)	
Чувствительность к колебаниям напряжения питания		≤ ± 1% для напряжения 12 ~ 24 В пост.тока	
Степень защиты		IP40	
Диапазон температур (°C)	Рабочих	0 ~ 50	
	Хранения	-20 ~ 70	
Напряжение пробоя изоляции		Между внешним контактом и корпусом 1000 VAC, 50/60 Гц в течение 1 мин.	
Сопротивление изоляции		50 МОм между внешним контактом и корпусом (при 50 VDC)	
Устойчивость к вибрациям		10 ~ 150 Гц с амплитудой до 1.5 мм или с ускорением 98 м/с ² в трех измерениях в течении 2 часов (в выключенном состоянии)	
Устойчивость к ударам		300 м/с ² в трех измерениях, не более 3 раз в каждом измерении	
Кабель		3-проводный кабель; 3м; 0.15мм ²	2-хпроводный кабель; 3м; 0.15мм ²
Влияние температуры ¹⁾		≤ ± 3% (от полного диапазона) при 25°C	
Присоединение		∅4.8 (под трубку с внутр. диаметром 4 мм)	
Вес (г)		75 (с кабелем)	

1) В рабочем диапазоне температур по сравнению с измерением при 25°C



Примеры применения

Контроль расхода воздуха в вентиляционной системе

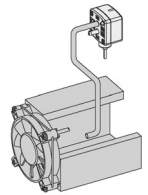

Контроль загрязненности фильтра в вентиляционной системе

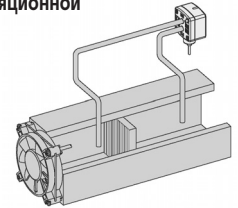

Контроль уровня жидкости

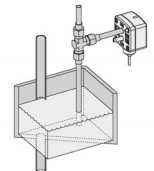

Размеры

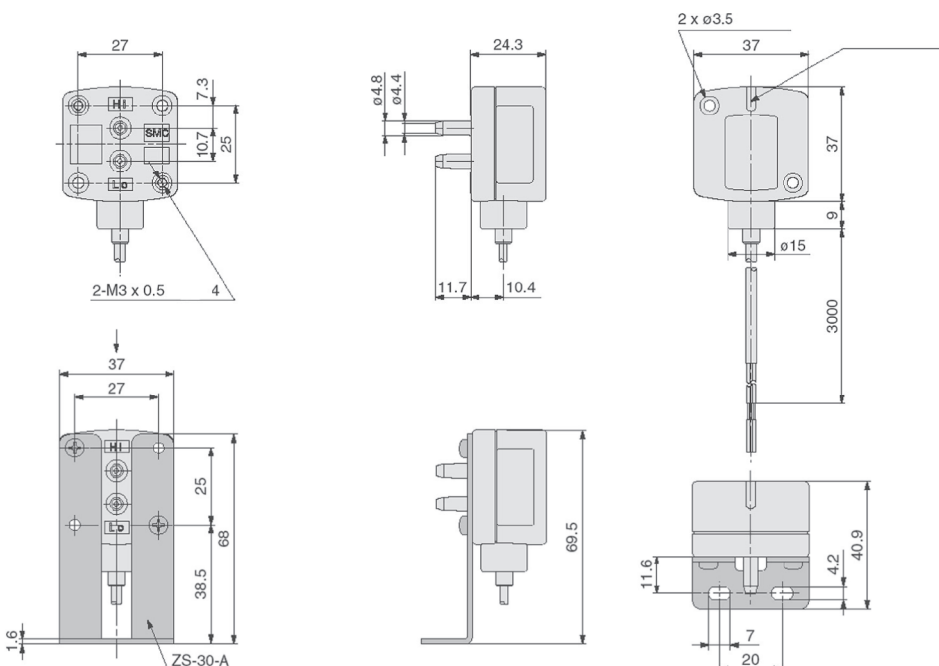

Электрическая схема и схема подключений

PSE550 Вход 1~5 В

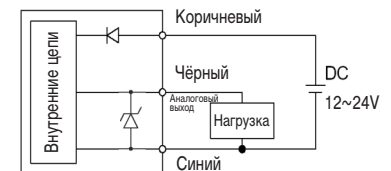

PSE550-28 Выход 4~20 мА

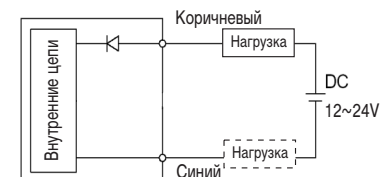

Нагрузку можно подключать как к "+" так и к "-"

Принадлежности
(заказываются отдельно)

Крепежный угольник	ZS-30-A
--------------------	---------

Low Differential Pressure Sensor Series *PSE550/300*

Rated differential pressure range:
0 to 2 kPa

Accuracy:
±1% F.S.

LED display to confirm energization

Proof pressure: 65 kPa

Output: 1 to 5 VDC/
(Analog output) 4 to 20 mA DC

Specifications:
PSE550
PRESS: 0 - 2 kPa | BROWN DC(+)
SUP: 12 - 24 VDC | BLACK ANALOG(-)
15 mA MAX | BLUE DC(-)

Options:
ZSE
ISE
PSE
ZSE3
PS
ZSE1
ZSE2
ZSP
ISA2
IS
ZSM
PF2
IF
Data

Applications

Flow control

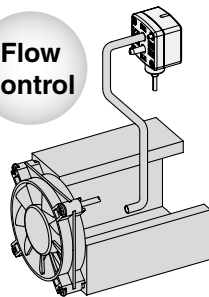

Can control air flow by monitoring the flow rate inside the duct.

Filter clogging monitoring

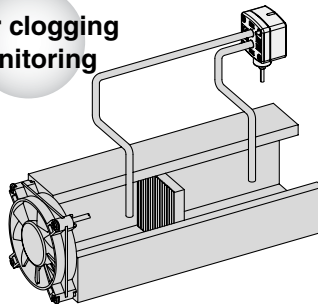

Can control filtration and replacement periods by monitoring the clogging of the filter.

Liquid level detection

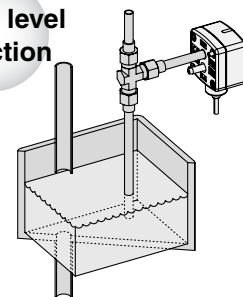

Can detect the liquid level through changes in the purge pressure.

Plug connection

Controller
PSE300

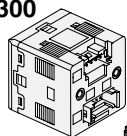

e-con connector

Low differential pressure sensor
PSE550



Two mounting methods

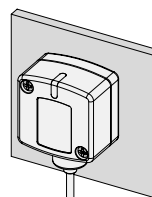

Direct mounting

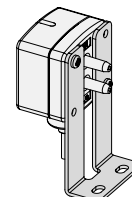

Bracket mounting



Low Differential Pressure Sensor

Series *PSE550*

How to Order

PSE550-□-□-□

Output specifications

Nil	Voltage output type 1 to 5 V
28	Current output type 4 to 20 mA

• **Option 2 (Connector)**

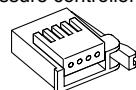
Nil	None
C2	Connector for PSE300 multiple channel pressure controller 1 pc. 

Note 1) Current output type cannot be connected to the Series PSE300.
Note 2) The connector is unassembled in the factory but is included with the shipment.



Option/Part No.

Description	Part no.	Note
Bracket	ZS-30-A	With M3 x 5L (2 pcs.)
Connector for PSE300	ZS-28-C	1 pc.

• **Option 1 (Bracket)**

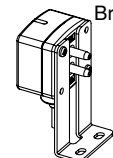
Nil	None
A	Bracket 

Note) The bracket is unassembled in the factory, but is included with the shipment.

Specifications

Model	PSE550	PSE550-28
Rated differential pressure range	0 to 2 kPa	
Operating pressure range	-50 to 50 kPa <small>Note)</small>	
Proof pressure	65 kPa	
Applicable fluid	Air/Non-corrosive gas/Non-inflammable gas	
Power supply voltage	12 to 24 VDC ±10%, Ripple (p-p) 10% or less (With power supply polarity protection)	
Current consumption	15 mA or less	—
Output specification	Analog output 1 to 5 VDC (Within rated differential pressure range) Output impedance: Approx. 1 kΩ	Analog output 4 to 20 mA DC (Within rated differential pressure range) Allowable load impedance: 500 Ω or less (at 24 VDC) 100 Ω or less (at 12 VDC)
Accuracy (Ambient temperature of 25°C)	±1% F.S. or less	
Linearity	±0.5% F.S. or less	
Repeatability	±0.3% F.S. or less	
Indication light	Orange light is on (When energized)	
Environmental resistance	Enclosure	IP40
	Operating temperature range	Operating: 0 to 50°C, Stored: -20 to 70°C (No freezing or condensation)
	Operating humidity range	Operating/Stored: 35 to 85% RH (No condensation)
	Withstand voltage	1000 VAC or more, 50/60 Hz for 1 minute between live parts and case
	Insulation resistance	50 MΩ or more between live parts and case (at 500 VDC)
Environmental resistance	Vibration resistance	10 to 150 Hz at whichever is smaller of 1.5 mm amplitude or 100 m/s ² acceleration, in X, Y, Z directions, for 2 hours each (De-energized)
	Impact resistance	300 m/s ² in X, Y, Z directions, 3 times each (De-energized)
Temperature characteristics	±3% F.S. or less (Based on 25°C)	
Port size	ø4.8 (ø4.4 in the end) resin piping (Applicable to I.D. ø4 air tubing)	
Material of wetted parts	Resin pipe: Nylon, Piston area of sensor: Silicon	
Sensor cable	3-wire oval cable (0.15 mm ²)	2-wire oval cable (0.15 mm ²)
Weight	With sensor cable	75 g
	Without sensor cable	35 g

Note) Can detect differential pressure from 0 to 2 kPa within the range of -50 to 50 kPa.

Analog Output

1 to 5 VDC

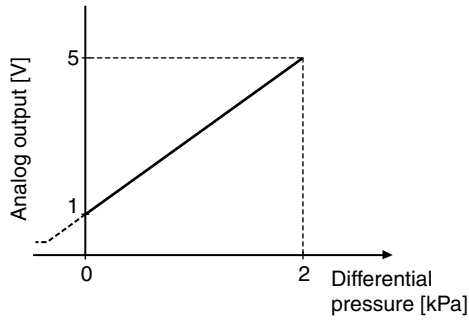

4 to 20 mA DC

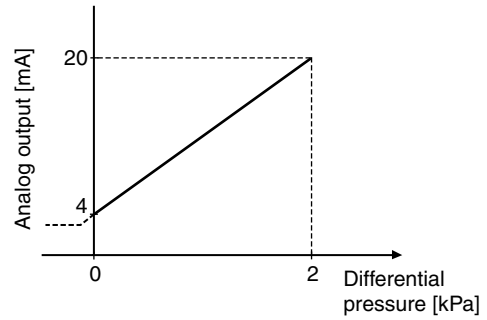

Internal Circuit

PSE550

Voltage output type
1 to 5 V
Output impedance
Approx. 1 k Ω

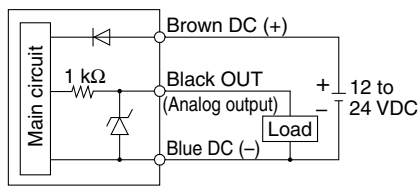

PSE550-28

Current output type
4 to 20 mA
Allowable load impedance
500 Ω or less (at 24 VDC)
100 Ω or less (at 12 VDC)

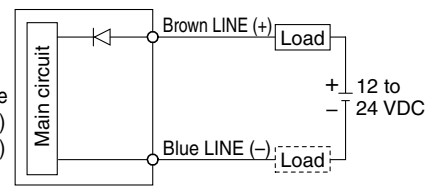

* Install the load either on the LINE (+) or LINE (-) side.

Dimensions

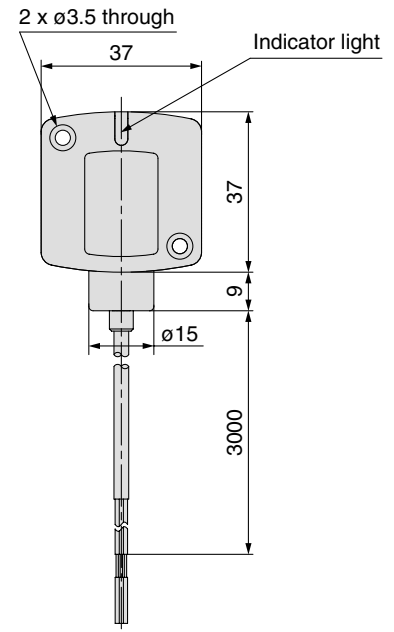
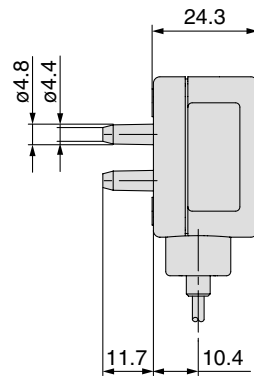
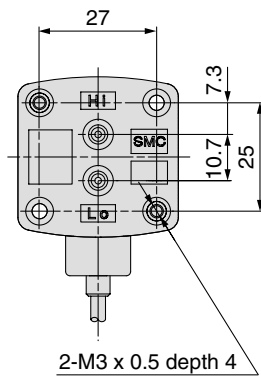

With bracket

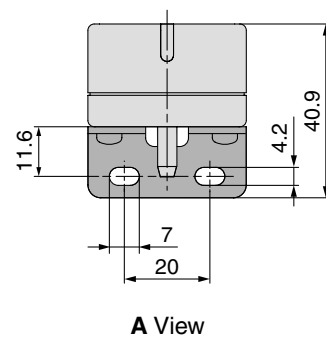
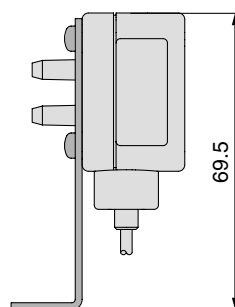
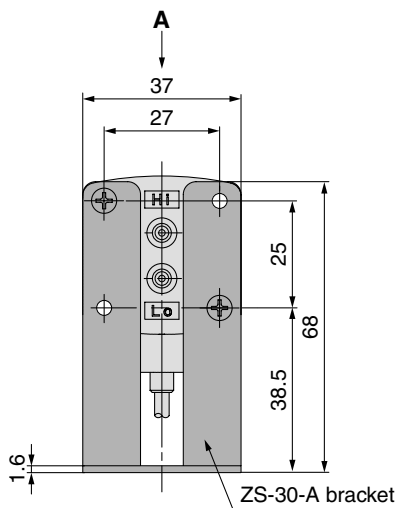



Series PSE

Specific Product Precautions 1

Be sure to read before handling.

Pressure Sensor

Handling

Warning

- Do not drop, bump, or apply excessive impact while handling. Although the body of the sensor may not be damaged, the inside of the sensor could be damaged and lead to malfunction.
- The tensile strength of the cord is 50 N or less. Applying a greater pulling force to it can cause malfunction. When handling, hold the body of the sensor—do not dangle it from the cord.
- Care should be taken when stripping the outer cable covering as the insulator may be accidentally torn or damaged if incorrectly stripped, as shown on the right.
- Do not use pressure sensors with corrosive and/or flammable gases or liquids.
- Connection of sensor connector

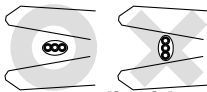

- Cut the sensor cable as illustrated to the right.
- Referring to the table below, insert each lead wire of the cable at the position marked with a number corresponding to the color of the lead wire.

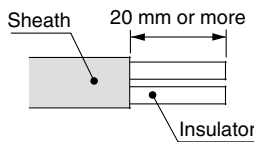

Connector no.	Wire core color For PSE300 (ZS-28-C)
1	Brown (DC (+))
2	Not connected
3	Blue (DC (-))
4	Black (OUT: 1 to 5 V)

- Confirm that the numbers on the connector match the colors of the wires and that the wires are inserted to the bottom. Press Part A by hand for temporary fixing.
- Press in the central part of Part A vertically with a tool such as pliers.
- A sensor connector cannot be taken apart for reuse once it is crimped. If the wire arrangement is incorrect or if the wire insertion fails, use a new sensor connector.

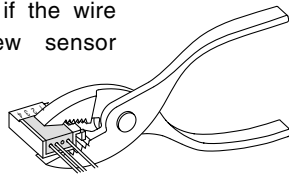
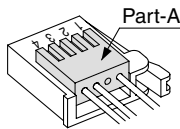

- For connection to SMC Series PSE300 pressure switches, use sensor connectors (ZS-28-C) or e-con connectors listed below.

Manufacturer	Part no.
Sumitomo 3M	37104-3101-000FL
Tyco Electronics AMP	1-1473562-4
OMRON Corporation	XN2A-1430

- For detailed information about e-con connectors, please consult the manufacturers of the respective connectors.
- When piping, increase the length of the air tubing to allow for any possible warping, increased tension or moment load or increased tension, etc.
- In cases where SMC air tubing is not used, make sure the product has similar I.D. accuracy within $\varnothing 4 \pm 0.3$ mm.

Handling

- Make sure that the air tubing is firmly inserted to avoid possible disconnection. (Tensile strength is approx. 25 N when being inserted 8 mm.)
- Please consult with SMC if you intend to use with fluids other than air, non-corrosive gas and non-inflammable gas.

Operating Environment

Warning

- The pressure sensors are CE marked; however, they are not equipped with surge protection against lightning. Lightning surge countermeasures should be applied directly to system components as necessary.
- The pressure sensors do not have an explosion proof rating. Never use pressure sensors in the presence of flammable or explosive gases.

Piping Connection

Caution

- Cut the air tubing vertically.
- Carefully hold the air tubing and slowly push it into the resin pipe, ensuring that it is inserted by more than 8 mm. For your information, the tensile strength is approx. 25 N when inserted by more than 8 mm.
- Insert the low pressure tubing into "Lo" pipe, and the high-pressure tubing into "Hi" pipe.

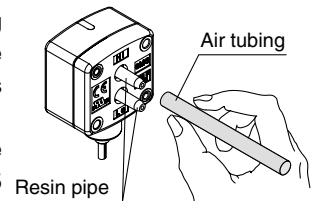

Controller

Handling

Warning

- Do not drop, bump, or apply excessive impact (100 m/s²) while handling. Although the body of the controller case may not be damaged, the inside of the controller could be damaged and cause malfunction.
- The tensile strength of the power supply/output connection cable is 50 N; that of the pressure sensor lead wire with connector is 25 N. Applying a greater pulling force than the applicable specified tensile strength to either of these components can lead to malfunction. When handling, hold the body of the controller.

ZSE□
ISE□

PSE

ZSE3

PS

ZSE1
ISE2

ZSP

ISA2

IS□

ZSM

PF2□

IF□

Data



Be sure to read before handling.

Controller

Connection

Warning

1. Incorrect wiring can damage the switch and cause malfunction or erroneous switch output. Connections should be done while the power is turned off.
2. Do not attempt to insert or pull out the pressure sensor or its connector when the power is on. Switch output may malfunction.
3. Wire separately from power lines and high voltage lines, avoiding wiring in the same conduit with these lines. Malfunctions may occur due to noise from these other lines.
4. If a commercial switching regulator is used, make sure that the F.G. terminal is grounded.

Operating Environment

Warning

1. Our pressure sensor controllers are CE marked; however, they are not equipped with surge protection against lightning. Lightning surge countermeasures should be applied directly to system components as necessary.
2. Our pressure sensor controllers do not have an explosion proof rating. Never use pressure sensors in the presence of flammable or explosive gases.

Mounting

Caution

1. Mounting with bracket

Mount the bracket on the body with two M3 x 5L mounting screws.

Tighten the bracket mounting screws at a tightening torque of 0.5 to 0.7 N·m.

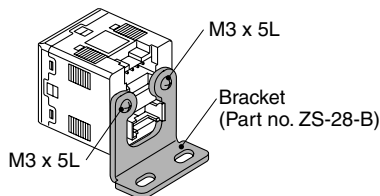

2. Mounting with panel mount adapter

Secure the panel mount adapter with two M3 x 8L mounting screws.

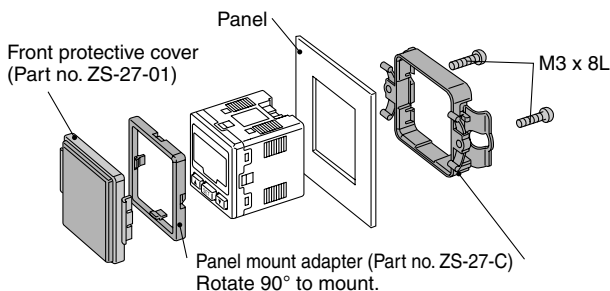

Mounting

3. Panel mount adapter removal

To remove the controller with panel mount adapter from the equipment, remove the two mounting screws, and pull out the controller while pushing the claws outward.

Failure to follow this procedure can cause damage to the controller and panel mount adapter.

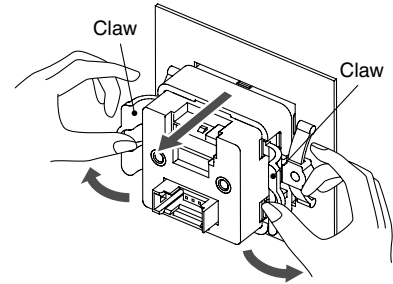

Wiring

Caution

1. Connection and removal of sensor connector

- Hold the lever and connector body with two fingers and insert the connector straight into the pin until it is locked with a click sound.
- To remove the connector, pull it out straight while pressing the lever with one finger.

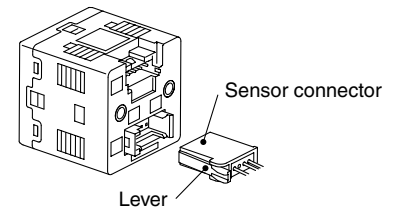

2. Connector pin numbers for power supply/output

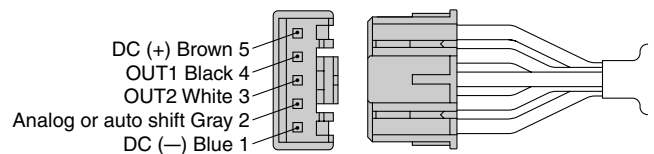



Series *PSE*

Specific Product Precautions 3

Be sure to read before handling.

Set Differential Pressure Range & Rated Differential Pressure Range

Caution

Set the pressure within the rated differential pressure range.

The set differential pressure range is the range of differential pressure that can be set on the controller. The rated differential pressure range is the range of differential pressure that satisfies the specifications (accuracy, linearity, etc.) of the sensor.

Although it is possible to set a value outside the rated differential pressure range, the specifications will not be guaranteed even if the valve stays within the set differential pressure range.

Sensor		Pressure range				
		-2 kPa	0	2 kPa	5 kPa	10 kPa
For low differential pressure	PSE550		0	2 kPa		
			-0.2 kPa	2 kPa		

Rated differential pressure range of sensor
 Set differential pressure range of controller

ZSE
ISE

PSE

ZSE3

PS

ZSE1
ZSE2

ZSP

ISA2

IS

ZSM

PF2

IF

Data