

High Purity Air Operated Chemical Liquid Valve

RoHS

Suppresses the generation of particles and reduced footprint!

Impact energy when the valve is closed (Proportional to V^2)
DOWN by 90 %

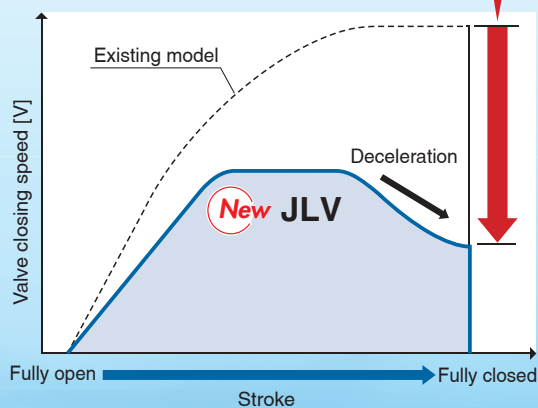

■ The special structure allows for reduced impact when the valve is closed as well as particle generation suppression.

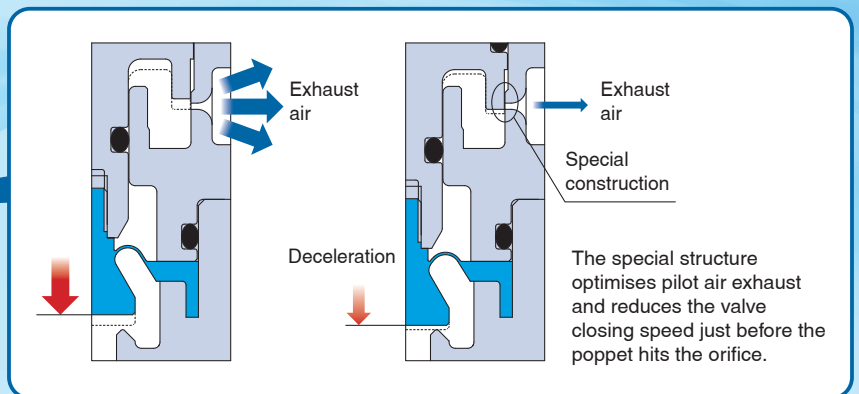
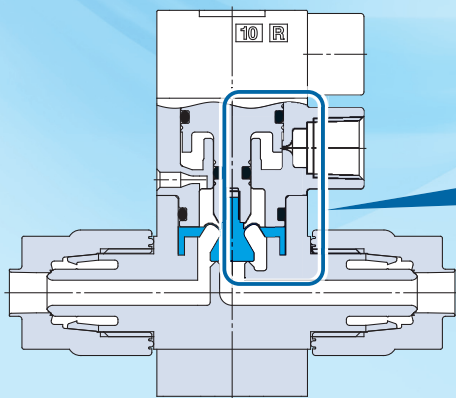

Variations

Body class	Valve type	Orifice diameter	Applicable tubing O.D.
2	N.C.	Ø 4	1/4
3		Ø 8	3/8

JLV20/30 Series



CAT.EUS70-60B-UK

Chemical-resistant materials are used.

Actuator section	PVDF
Poppet	PTFE
Body	New PFA
End plate	PVDF

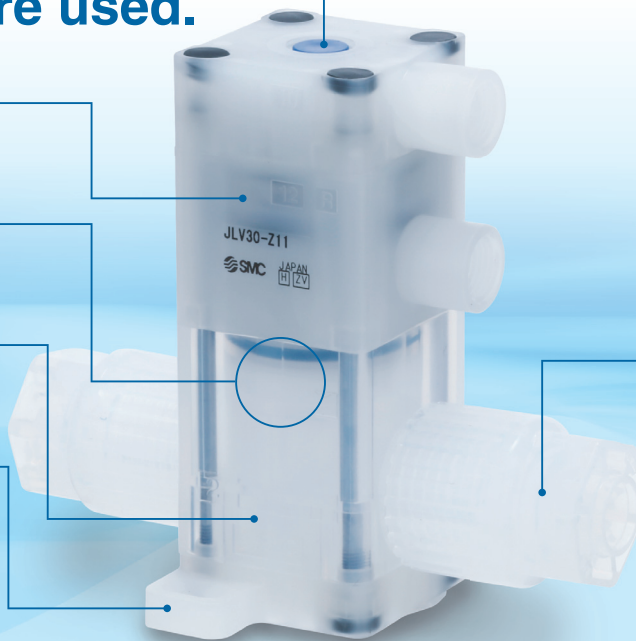

With indicator

Visual confirmation of the valve open/close status

Valve open



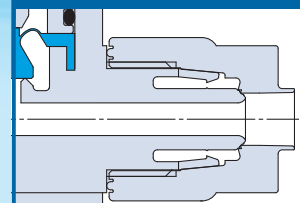

Hyper fittings Flare type LQ3 Series



- Flare type collet construction
- Triple-seal construction

Reduced footprint

	JLV [mm]	Existing model [mm]	Reduction
 Body class 2	Valve width	24	30 6 mm (20% reduction)
	Mounting pitch	31	56 25 mm (45% reduction)
	Overall length A	71	77 6 mm (8% reduction)
 Body class 3	Valve width	32	35 3 mm (9% reduction)
	Mounting pitch	42.5	62 19.5 mm (32% reduction)
	Overall length A	100	103 3 mm (3% reduction)

Mounting pitch **Max. 45 % reduction**

Valve width **Max. 20 % reduction**

* Body class 2

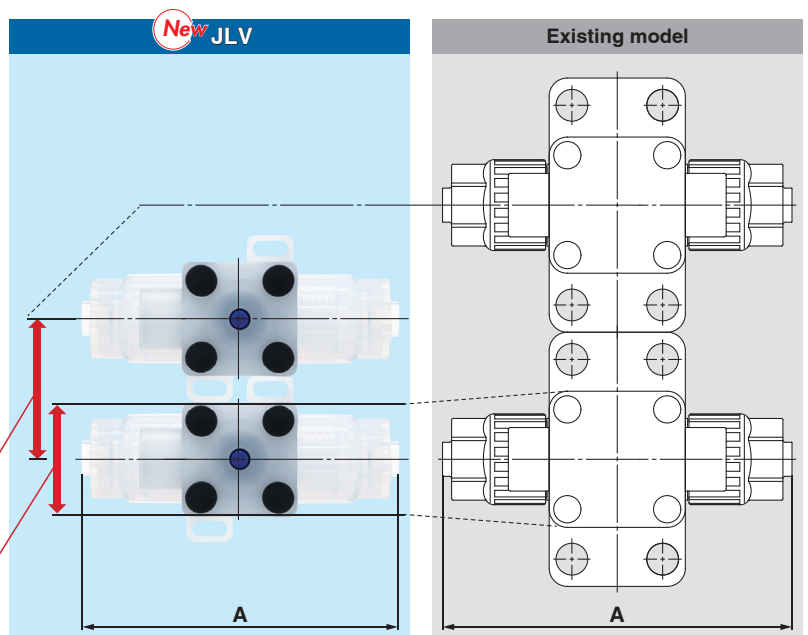

Applicable for applications requiring high pressure/high back pressure

Expanded and standardised operating pressure/back pressure range

Operating pressure: **0 to 0.5 MPa**

(Improved by up to 66 % compared with the existing model)

* Body class 3

Back pressure: **0 to 0.5 MPa**

(Improved by up to 150 % compared with the existing model)

* Body class 3

High Purity Air Operated Chemical Liquid Valve

JLV20/30 Series

RoHS

How to Order

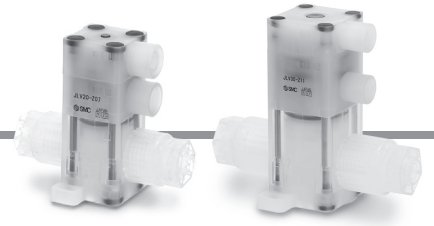

JLV 2 0 - Z 07 F

Body class

Symbol	Body class	Orifice diameter
2	2	Ø 4
3	3	Ø 8

Pilot port thread type

Symbol	Thread type
—	Rc1/8
N	NPT1/8
F	G1/8

Symbol

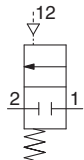

N.C. valve

Valve type

Symbol	Valve type
0	N.C.

Applicable tubing size

Symbol	Applicable tubing size	Body class	
		2	3
07	1/4" x 5/32"	○	
11	3/8" x 1/4"		○

Fitting type

Symbol	Fitting type
Z	LQ3

Specifications

Model	JLV20	JLV30
Tubing O.D.	1/4	3/8
Orifice diameter	Ø 4	Ø 8
Cv factor	0.35	1.3
Valve type	N.C.	
Withstand pressure [MPa]	1	
Operating pressure (1 → 2) [MPa]	0 to 0.5	
Back pressure [MPa]	0.5 or less	
Valve leakage [cm ³ /min]	0 (with water pressure)	
Pilot air pressure [MPa]	0.35 to 0.5	
Pilot port size	Rc1/8, NPT1/8, G1/8	
Fluid temperature [°C]	0 to 120	
Ambient temperature [°C]	0 to 60	
Operating frequency	30 cycles/min or less	
Weight [kg]	0.08	0.17

Construction

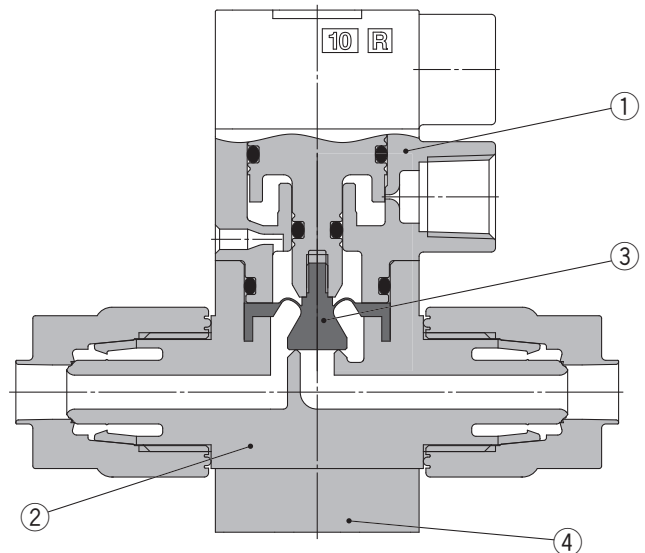

Component Parts

No.	Description	Material
①	Actuator section	PVDF
②	Body	PFA
③	Poppet	PTFE
④	End plate	PVDF

JLV20/30 Series

Dimensions

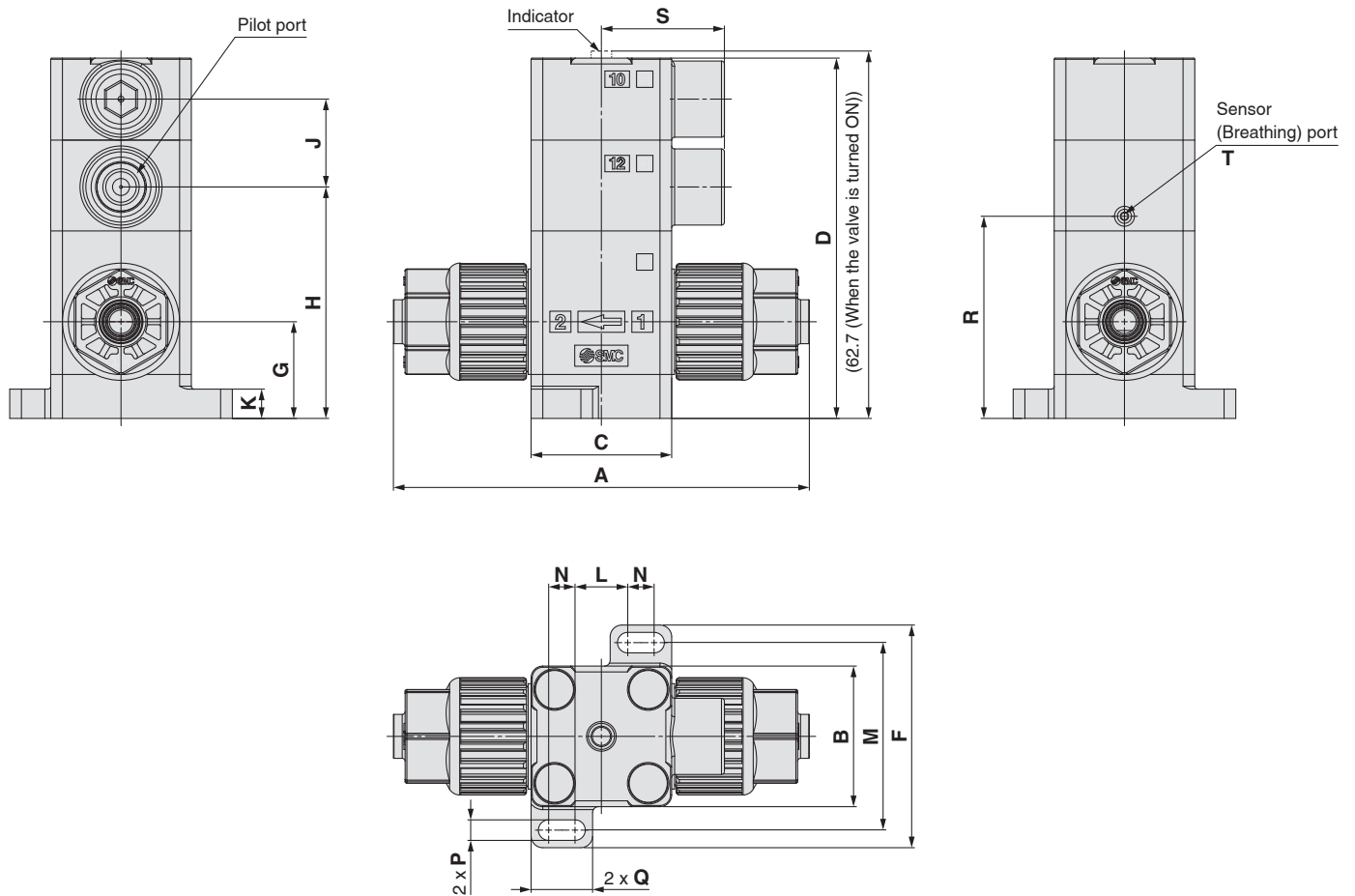

Model	A	B	C	D	E	F	G	H	J	K	L	M	N	P	Q	R	S	T
JLV20-Z07□	71	24	24	61.5	62.7	38	16.5	39.5	15	5	9	32	4.5	3.5	10.5	34.5	21	∅ 2.4
JLV30-Z11□	100	32	32	84.5	86.5	53	19.5	54	23.5	5.5	13.5	43.5	4.5	5.5	14	46.3	27.5	∅ 2.4

[mm]

⚠ Precautions

Be sure to read this before handling the products. Refer to the back cover for safety instructions. For high purity air operated chemical liquid valve precautions, refer to pages 5 and 6.



JLV20/30 Series Applicable Fluids

Material and Fluid Compatibility Check List for High Purity Air Operated Chemical Liquid Valves

Chemical	Compatibility
Acetone	○*1, *2
Ammonium hydroxide	○*2
Isobutyl alcohol	○*1, *2
Isopropyl alcohol	○*1, *2
Hydrochloric acid	○
Ozone (dry)	○
Hydrogen peroxide Concentration 5 % or less, 50 °C or less	○
Ethyl acetate	○*1, *2
Butyl acetate	○*1, *2
Nitric acid (except fuming nitric acid) Concentration 10 % or less	○*2
Deionised water (pure water)	○
Sodium hydroxide (caustic soda) Concentration 50 % or less	○
Nitrogen gas	○
Super pure water	○
Toluene	○*1, *2
Hydrofluoric acid	○*2
Sulfuric acid (except fuming sulfuric acid)	○*2
Phosphoric acid Concentration 80 % or less	○

Table symbols ○ : Can be used
○* : Can be used in certain conditions
× : Cannot be used

The material and fluid compatibility check list provides reference values as a guide only.

- *1 Since static electricity may be generated, implement suitable countermeasures.
- *2 Use caution as permeation may occur. The permeated fluid may effect the parts of other materials.

- Compatibility is indicated for fluid temperatures of 100 °C or less.
- The material and fluid compatibility check list provides reference values as a guide only, therefore we do not guarantee the application to our product.
- The data above is based on the information presented by the material manufacturers.
- SMC is not responsible for its accuracy and any damage happened because of this data.
- Use a fluid with a viscosity of 300 cp or less. Failure to do so may cause valve closing failure.



JLV20/30 Series

High Purity Air Operated Chemical Liquid Valve Precautions 1

Be sure to read this before handling the products.

Design / Selection

Warning

1. Confirm the specifications.

Give careful consideration to the operating conditions, such as the application, fluid, and environment, and use within the specified operating ranges indicated in the catalogue.

2. Cannot be used as an emergency shutoff valve, etc.

The valves presented in this catalogue are not designed to be used as emergency shutoff valves in safety applications. If the valves are used in this type of system, other reliable safety assurance measures should also be adopted.

3. Ensure sufficient space for maintenance activities.

When installing the products, allow access for maintenance and inspection.

4. Liquid seals

When circulating fluid:

Provide a relief valve in the system so that fluid does not get into the liquid seal circuit.

5. Countermeasures against static electricity

Take measures to prevent static electricity, since some fluids can cause static electricity.

6. Fluids

Operate after confirming the compatibility of the product's component materials with fluids, using the check list on page 4. Please contact SMC regarding fluids other than those in the check list.

In addition, the use of a fluid that contains foreign matter may cause problems such as seal failure. Install a suitable filter immediately upstream from the valve to counteract this.

7. Fluid pressure range

Keep the supplied fluid pressure within the operating pressure range specified in this catalogue.

8. Fluid temperature range

Keep the supplied fluid temperature within the fluid temperature range specified in this catalogue. In addition, make sure that there is no freezing.

9. Ambient environment

Use within the operable ambient temperature range. Confirm the compatibility between the product's composition materials and the ambient atmosphere. Be certain that the fluid used does not touch the external surface of the product.

Mounting

Warning

1. If air leakage increases or equipment does not operate properly, stop operation.

After mounting, perform suitable function and leakage tests to confirm that the product has been mounted correctly.

2. When mounting the valve, secure the product in place so that it is not only supported by the fitting.

Piping

Caution

1. Preparation before piping

Before piping is connected, it should be thoroughly blown out with air (flushing) or washed to remove chips, cutting oil, and other debris from inside the pipe.

Install piping so that it does not apply pulling, pressing, bending, or other forces on the valve body.

2. Use the tightening torque shown below for the threaded pilot port.

Tightening Torque for the Pilot Port

Pilot port	Torque [N·m]
Rc, NPT, G1/8	0.8 to 1.0

Do not use metal fittings for the piping as they may cause damage to the threads.

3. For information on tubing connection and special tools, please refer to the pamphlet "High Purity Fluoropolymer Fittings Hyper Fitting/Flare Type LQ3 Series Fitting Procedure" (M-E06-4). (The pamphlet can be downloaded from the SMC website.)

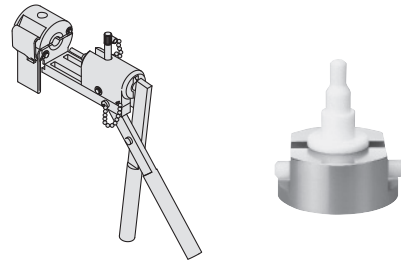

4. Refer to the applicable tubing sizes shown below to select fluoropolymer tubing.

Applicable Tubing Sizes

	Connection tubing size	O.D. [mm]		Internal thickness [mm]	
		Standard size	Tolerance	Standard size	Tolerance
Inch sizes	1/4" x 5/32"	6.35	+0.2	1.2	±0.12
	3/8" x 1/4"	9.53	-0.1	1.6	±0.15

5. Install piping so that the arrow on the product matches the flow of the fluid.

6. Tighten the nut until it touches the end surface of the body, and then tighten it an additional 1/8 turn. If the nut won't turn any further, then it means it has been tightened sufficiently. Refer to the proper tightening torques shown below.

Tightening Torque for the Piping

Body class	Torque [N·m]
	LQ3
2	1.6 to 1.8
3	3.2 to 3.5



JLV20/30 Series

High Purity Air Operated Chemical Liquid Valve Precautions 2

Be sure to read this before handling the products.

Operating Air Supply

Warning

1. Use clean air.

Do not use compressed air that contains chemicals, synthetic oils that include organic solvents, salt, corrosive gases, etc., as it can cause damage or malfunction.

Operating Environment

Warning

1. Do not use in a location having an explosive atmosphere.
2. Do not use in a place subject to heavy vibration and/or shock.
3. Do not use in locations where radiated heat will be received from nearby heat sources.
4. Do not use in environments which exceed the ambient temperature specifications of the product.

Maintenance

Warning

1. Before removing equipment or compressed air supply/exhaust devices, shut off the air and power supplies, and exhaust compressed air from the system. Further, when restarting equipment after remounting or replacement, first confirm safety and then check the equipment for normal operation.
2. Perform work after removing residual chemicals and carefully replacing them with pure water or air, etc.
3. Do not disassemble the product, as disassembly will invalidate the product's warranty.
When disassembly is necessary, please consult with SMC or our distributor.
4. In order to obtain optimum performance from valves, perform periodic inspections to confirm that there are no leaks from valves or fittings, etc.

Caution

1. Drain flushing

Remove drainage from the air filters regularly.

Operation

Warning

1. Operate within the ranges of the max. operating pressure and back pressure.

Caution

1. Please note that when the product is shipped from the factory, gases such as N₂ and air may leak from the valve at a rate of 1 cm³/min (when pressurised).
2. Water hammering may occur depending on the fluid pressure conditions. In most cases, improvement is possible by adjusting the pilot pressure with a speed controller, etc., but the flow rate, pressure and piping conditions should be reviewed.
3. After a long period of non-use, perform a trial run prior to operation.
4. Since the product is packaged in a clean room, use sufficient care in handling when opened.



Return of Product

Warning

If the product to be returned is contaminated or is possibly contaminated with substances that are harmful to humans, for safety reasons, please contact SMC beforehand and then employ a specialist cleaning company to decontaminate the product. After the decontamination prescribed above has been carried out, please submit a Product Return Request Sheet or the Detoxification/Decontamination Certificate to SMC and await SMC's approval and further instructions before attempting to return the item. Please refer to the International Chemical Safety Cards (ICSC) for a list of harmful substances. If you have any further questions, please don't hesitate to contact your SMC sales representative.

Safety Instructions

These safety instructions are intended to prevent hazardous situations and/or equipment damage. These instructions indicate the level of potential hazard with the labels of “Caution,” “Warning” or “Danger.” They are all important notes for safety and must be followed in addition to International Standards (ISO/IEC)¹⁾, and other safety regulations.

-  **Caution:** **Caution** indicates a hazard with a low level of risk which, if not avoided, could result in minor or moderate injury.
-  **Warning:** **Warning** indicates a hazard with a medium level of risk which, if not avoided, could result in death or serious injury.
-  **Danger:** **Danger** indicates a hazard with a high level of risk which, if not avoided, will result in death or serious injury.

- 1) ISO 4414: Pneumatic fluid power – General rules relating to systems.
ISO 4413: Hydraulic fluid power – General rules relating to systems.
IEC 60204-1: Safety of machinery – Electrical equipment of machines.
(Part 1: General requirements)
ISO 10218-1: Manipulating industrial robots - Safety.
etc.

Warning

1. The compatibility of the product is the responsibility of the person who designs the equipment or decides its specifications.

Since the product specified here is used under various operating conditions, its compatibility with specific equipment must be decided by the person who designs the equipment or decides its specifications based on necessary analysis and test results. The expected performance and safety assurance of the equipment will be the responsibility of the person who has determined its compatibility with the product. This person should also continuously review all specifications of the product referring to its latest catalogue information, with a view to giving due consideration to any possibility of equipment failure when configuring the equipment.

2. Only personnel with appropriate training should operate machinery and equipment.

The product specified here may become unsafe if handled incorrectly. The assembly, operation and maintenance of machines or equipment including our products must be performed by an operator who is appropriately trained and experienced.

3. Do not service or attempt to remove product and machinery/equipment until safety is confirmed.

1. The inspection and maintenance of machinery/equipment should only be performed after measures to prevent falling or runaway of the driven objects have been confirmed.
2. When the product is to be removed, confirm that the safety measures as mentioned above are implemented and the power from any appropriate source is cut, and read and understand the specific product precautions of all relevant products carefully.
3. Before machinery/equipment is restarted, take measures to prevent unexpected operation and malfunction.

4. Contact SMC beforehand and take special consideration of safety measures if the product is to be used in any of the following conditions.

1. Conditions and environments outside of the given specifications, or use outdoors or in a place exposed to direct sunlight.
2. Installation on equipment in conjunction with atomic energy, railways, air navigation, space, shipping, vehicles, military, medical treatment, combustion and recreation, or equipment in contact with food and beverages, emergency stop circuits, clutch and brake circuits in press applications, safety equipment or other applications unsuitable for the standard specifications described in the product catalogue.
3. An application which could have negative effects on people, property, or animals requiring special safety analysis.
4. Use in an interlock circuit, which requires the provision of double interlock for possible failure by using a mechanical protective function, and periodical checks to confirm proper operation.

Caution

1. The product is provided for use in manufacturing industries.

The product herein described is basically provided for peaceful use in manufacturing industries.
If considering using the product in other industries, consult SMC beforehand and exchange specifications or a contract if necessary.
If anything is unclear, contact your nearest sales branch.

Limited warranty and Disclaimer/Compliance Requirements

The product used is subject to the following “Limited warranty and Disclaimer” and “Compliance Requirements”. Read and accept them before using the product.

Limited warranty and Disclaimer

1. The warranty period of the product is 1 year in service or 1.5 years after the product is delivered, whichever is first.²⁾ Also, the product may have specified durability, running distance or replacement parts. Please consult your nearest sales branch.
2. For any failure or damage reported within the warranty period which is clearly our responsibility, a replacement product or necessary parts will be provided. This limited warranty applies only to our product independently, and not to any other damage incurred due to the failure of the product.
3. Prior to using SMC products, please read and understand the warranty terms and disclaimers noted in the specified catalogue for the particular products.
- 2) Vacuum pads are excluded from this 1 year warranty.
A vacuum pad is a consumable part, so it is warranted for a year after it is delivered. Also, even within the warranty period, the wear of a product due to the use of the vacuum pad or failure due to the deterioration of rubber material are not covered by the limited warranty.

Compliance Requirements

1. The use of SMC products with production equipment for the manufacture of weapons of mass destruction (WMD) or any other weapon is strictly prohibited.
2. The exports of SMC products or technology from one country to another are governed by the relevant security laws and regulations of the countries involved in the transaction. Prior to the shipment of a SMC product to another country, assure that all local rules governing that export are known and followed.

Caution

SMC products are not intended for use as instruments for legal metrology.

Measurement instruments that SMC manufactures or sells have not been qualified by type approval tests relevant to the metrology (measurement) laws of each country. Therefore, SMC products cannot be used for business or certification ordained by the metrology (measurement) laws of each country.

Safety Instructions

Be sure to read “Handling Precautions for SMC Products” (M-E03-3) before using.

SMC Corporation (Europe)

Austria	+43 (0)2262622800	www.smc.at	office@smc.at
Belgium	+32 (0)33551464	www.smc.be	info@smc.be
Bulgaria	+359 (0)2807670	www.smc.bg	office@smc.bg
Croatia	+385 (0)13707288	www.smc.hr	office@smc.hr
Czech Republic	+420 541424611	www.smc.cz	office@smc.cz
Denmark	+45 70252900	www.smc.dk.com	smc@smcdk.com
Estonia	+372 651 0370	www.smcee.ee	info@smcee.ee
Finland	+358 207513513	www.smc.fi	smcfi@smc.fi
France	+33 (0)164761000	www.smc-france.fr	supportclient@smc-france.fr
Germany	+49 (0)61034020	www.smc.de	info@smc.de
Greece	+30 210 2717265	www.smchellas.gr	sales@smchellas.gr
Hungary	+36 23513000	www.smc.hu	office@smc.hu
Ireland	+353 (0)14039000	www.smcautomation.ie	sales@smcautomation.ie
Italy	+39 03990691	www.smcitalia.it	mailbox@smcitalia.it
Latvia	+371 67817700	www.smc.lv	info@smc.lv

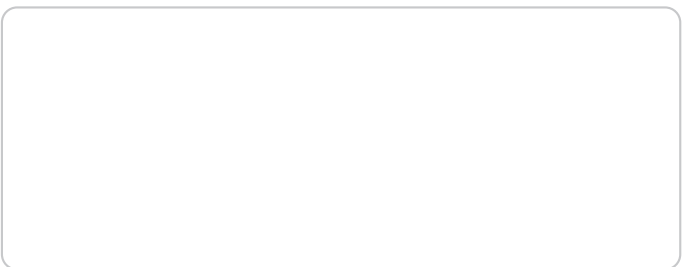

Lithuania	+370 5 2308118	www.smclt.lt	info@smclt.lt
Netherlands	+31 (0)205318888	www.smc.nl	info@smc.nl
Norway	+47 67129020	www.smc-norge.no	post@smc-norge.no
Poland	+48 222119600	www.smc.pl	office@smc.pl
Portugal	+351 214724500	www.smc.eu	apoioclientept@smc.smces.es
Romania	+40 213205111	www.smcromania.ro	smcromania@smcromania.ro
Russia	+7 (812)3036600	www.smc.eu	sales@smcru.com
Slovakia	+421 (0)413213212	www.smc.sk	office@smc.sk
Slovenia	+386 (0)73885412	www.smc.si	office@smc.si
Spain	+34 945184100	www.smc.eu	post@smc.smces.es
Sweden	+46 (0)86031240	www.smc.nu	smc@smc.nu
Switzerland	+41 (0)523963131	www.smc.ch	info@smc.ch
Turkey	+90 212 489 0 440	www.smcturkey.com.tr	satis@smcturkey.com.tr
UK	+44 (0)845 121 5122	www.smc.uk	sales@smc.uk
South Africa	+27 10 900 1233	www.smcza.co.za	zasales@smcza.co.za