

# Hygienic Design Cylinder

# Series HYG

∅20, ∅25, ∅32, ∅40, ∅50, ∅63

## How to Order

Without auto switch

HYG 20 [ ] R 50 F

With auto switch

HYDYG 20 [ ] R 50 F F6B [ ]

With auto switch  
(Built-in magnet and switch rail)

Bore size

20	20 mm
25	25 mm
32	32 mm
40	40 mm
50	50 mm
63	63 mm

Port thread type

Nil	M thread	∅20, ∅25
	Rc	
TN	NPT	∅32 to ∅63
TF	G	

Sealant material

R	NBR
H	External FKM <sup>Note)</sup>

Note) External sealant: Scraper, rod seal, O ring (rod end) and seal washer are made from FKM.

Number of auto switches

Nil	2 pcs.
S	1 pc.
n	"n" pcs.

Auto switch

Nil	Without auto switch (Built-in magnet and switch rail)
-----	--

Refer to the table below for selection of applicable auto switch.  
Auto switch is shipped not assembled with the cylinder.

Grease

Nil	Standard grease (for non-food)
F	Grease for food

Note) Select grease for food for use in a water dispersion environment or when washing a product with water.  
(Water resistance is insufficient with standard grease.)

Cylinder stroke

Refer to the next page for the standard stroke.

Optional parts (plug bolt) should be ordered separately.  
Please refer to page 35 for details.

### Applicable Auto Switches/Refer to page 37 for detailed auto switch specifications.

Type	Electrical entry	Indicator light	Wiring (Output)	Load voltage		Auto switch model	Lead wire length (m)*			Pre-wired connector	Applicable load	
				DC			0.5 (Nil)	3 (L)	5 (Z)			
Solid state switch	Grommet	Yes	3-wire (NPN)	24 V	5 V	F6N	●	●	○	○	IC circuit	Relay, PLC
			3-wire (PNP)		12 V	F6P	●	●	○			
			2-wire		12 V	F6B	●	●	○			

\* Lead wire length symbols 0.5 m.. Nil (Example) F6N  
3 m.. l (Example) F6NI  
5 m.. Z (Example) F6NZ

\* Auto switches marked with a "○" symbol are produced upon receipt of orders.

• Refer to "SMC Best Pneumatics" catalog vol. 10, page 10-20 66 for detailed specifications about the auto switch with pre wired connector.



## Specifications

Bore size (mm)	20	25	32	40	50	63
<b>Action</b>	Double acting					
<b>Fluid</b>	Air					
<b>Minimum operating pressure</b>	0.2 MPa		0.15 MPa			
<b>Maximum operating pressure</b>	1.0 MPa					
<b>Proof pressure</b>	1.5 MPa					
<b>Ambient and operating fluid temperature</b>	0°C to 60°C					
<b>Lubrication</b>	Not required					
<b>Piston speed</b>	50 to 500 mm/s (With pressure at 1.0 MPa) <sup>Note)</sup>					
<b>Cushion</b>	Rubber bumper					
<b>Stroke length tolerance</b>	$^{+1.5}_0$ mm					

Note) Use a cylinder below the allowable kinetic energy. Refer to page 24 for the allowable kinetic energy.

## Standard Stroke

Bore size (mm)	Standard stroke (mm)
<b>20</b>	20, 30, 50, 100, 150, 200
<b>25</b>	20, 30, 50, 100, 150, 200
<b>32</b>	25, 50, 100, 150, 200
<b>40</b>	25, 50, 100, 150, 200
<b>50</b>	25, 50, 100, 150, 200
<b>63</b>	25, 50, 100, 150, 200

\* Manufacture of Intermediate Stroke

Intermediate strokes of mm each can be produced by using spacers with standard stroke cylinders. However, intermediate strokes of 5 mm each can be produced about ø40 to 63.

Example) HYG32R-57 mounts a 43mm spacer in standard stroke cylinder HYG32R-100.

## Weight

### Without auto switch

Unit: kg

Bore size (mm)	Stroke (mm)						
	20	25	30	50	100	150	200
<b>20</b>	0.77	—	0.86	1.10	1.68	2.24	2.42
<b>25</b>	1.17	—	1.29	1.61	2.40	3.15	3.43
<b>32</b>	—	2.04	—	2.56	3.61	4.59	5.43
<b>40</b>	—	2.31	—	2.90	4.12	5.23	6.17
<b>50</b>	—	3.79	—	4.64	6.43	8.04	9.41
<b>63</b>	—	4.71	—	5.74	7.95	9.92	11.56

### With auto switch (Built-in magnet and switch rail)

Unit: kg

Bore size (mm)	Stroke (mm)						
	20	25	30	50	100	150	200
<b>20</b>	0.80	—	0.89	1.12	1.71	2.26	2.45
<b>25</b>	1.19	—	1.32	1.63	2.43	3.18	3.47
<b>32</b>	—	2.07	—	2.60	3.66	4.66	5.51
<b>40</b>	—	2.35	—	2.94	4.96	5.30	6.25
<b>50</b>	—	3.83	—	4.68	6.48	8.11	9.49
<b>63</b>	—	4.75	—	5.79	8.01	9.99	11.65

## Theoretical Output

Unit: N

Bore size (mm)	Operating direction	Operating pressure (MPa)		
		0.3	0.5	0.7
<b>20</b>	IN	71	118	165
	OUT	94	157	220
<b>25</b>	IN	113	189	265
	OUT	147	246	344
<b>32</b>	IN	181	302	422
	OUT	241	402	563
<b>40</b>	IN	317	528	739
	OUT	377	629	880
<b>50</b>	IN	495	825	1154
	OUT	589	982	1374
<b>63</b>	IN	841	1402	1962
	OUT	935	1559	2182

## Plate Allowable Rotational Torque

Strictly observe the values in the following table regarding rotational torque (T) pressurized to the plate (rod end).

When operated outside of the acceptable range, it can decrease the machine's service life.

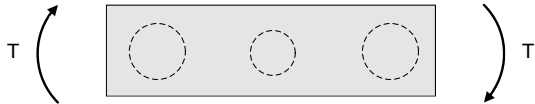

Unit: N·m

Bore size (mm)	Stroke (mm)						
	20	25	30	50	100	150	200
<b>20</b>	0.72	—	0.60	0.57	0.51	0.45	0.37
<b>25</b>	1.29	—	1.18	1.04	0.97	0.83	0.68
<b>32</b>	—	3.23	—	3.07	2.87	2.59	2.24
<b>40</b>	—	3.56	—	3.39	3.16	2.86	2.47
<b>50</b>	—	7.83	—	6.80	5.88	5.25	4.61
<b>63</b>	—	8.83	—	7.67	6.63	5.92	5.20

## Plate Non-rotating Accuracy

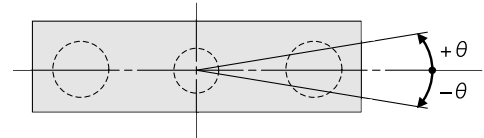

Bore size (mm)	Non-rotating accuracy $\theta$
<b>20</b>	$\pm 0.10$
<b>25</b>	$\pm 0.09$
<b>32</b>	$\pm 0.08$
<b>40</b>	$\pm 0.08$
<b>50</b>	$\pm 0.07$
<b>63</b>	$\pm 0.06$

\* When the cylinder retracts (initial value), for non-rotating accuracy in load-free states and/or except the guide rod deflection, use a value that does not exceed those listed above.

## Plate Allowable Moment

Strictly observe the values in the following table regarding allowed moment when eccentric distance is generated from the plate.

When operated outside of the acceptable range, it can decrease the machine's service life.

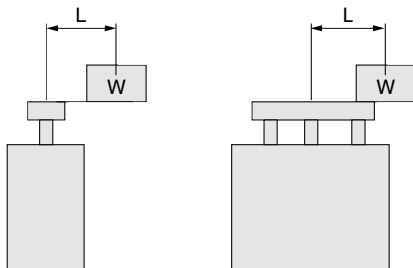

Allowable moment (N·m)	$\phi 20$	$\phi 25$	$\phi 32, \phi 40$	$\phi 50, \phi 63$
	3.57	5.07	21.5	35.3

# Series HYG

## Plate Allowable Lateral Load

Strictly observe the values in the following graph regarding lateral loads hanging upon the plate end point. When operated outside of the acceptable range, it can decrease the machine's service life.

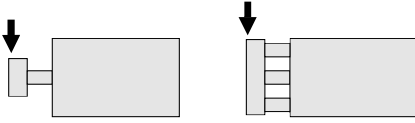

**HYG20**

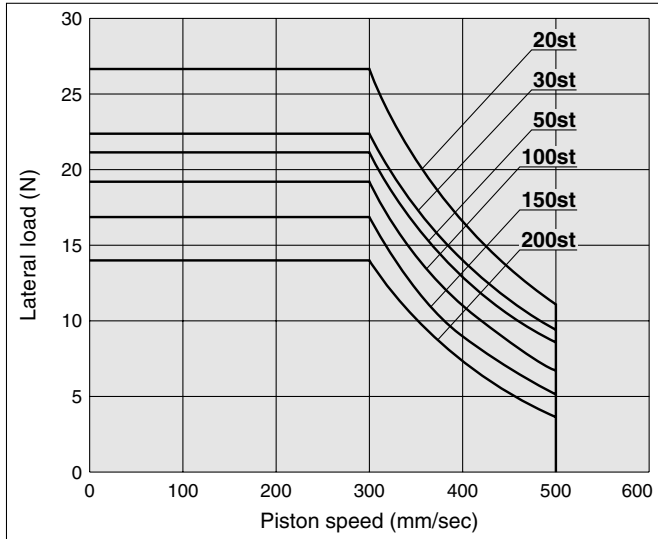

**HYG25**

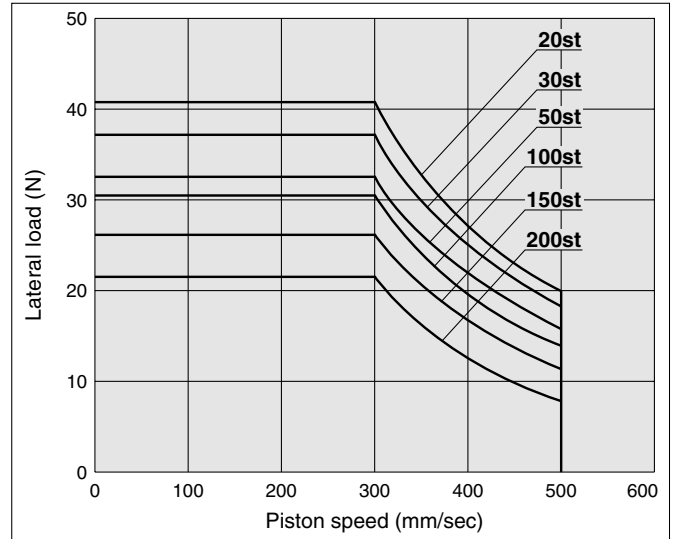

**HYG32, 40**

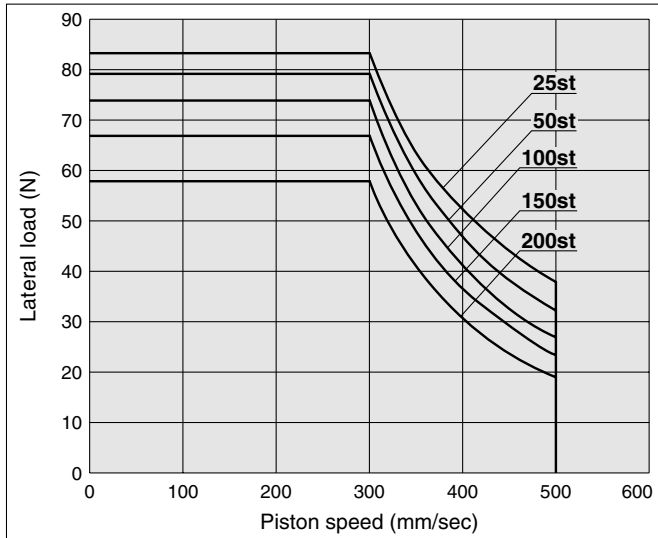

**HYG50, 63**

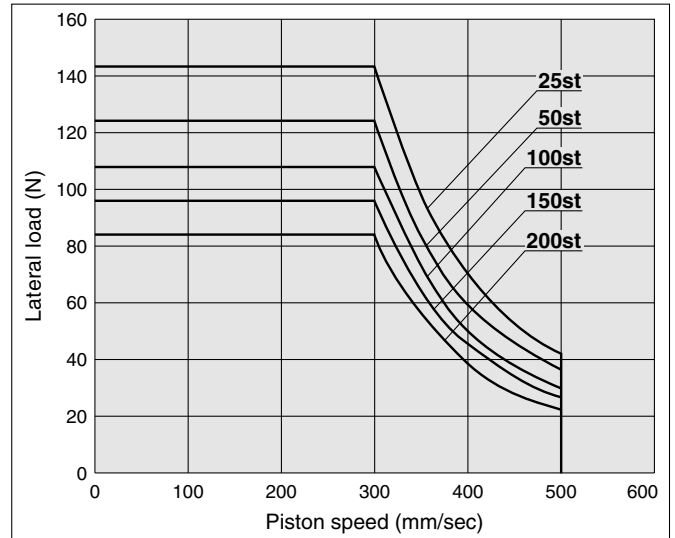

## Allowable Kinetic Energy

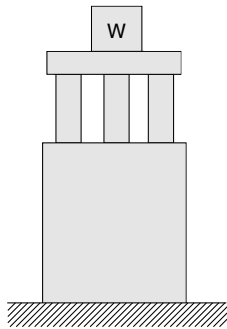

(Supply pressure: at P 0.5 MPa)

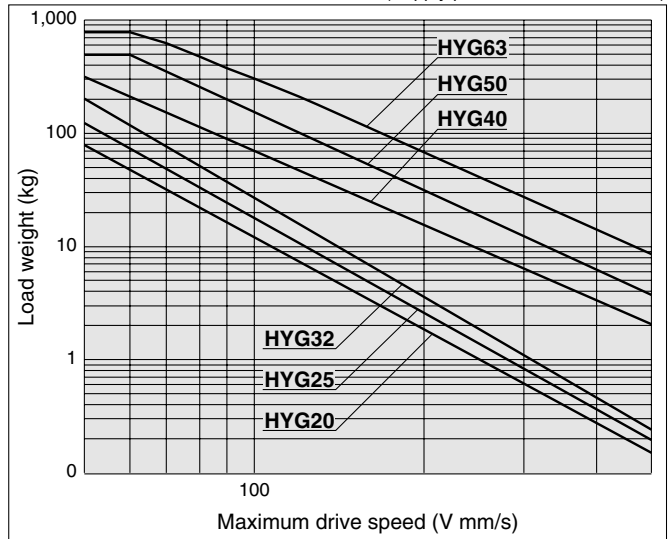

## Operating Range When Used as Stopper

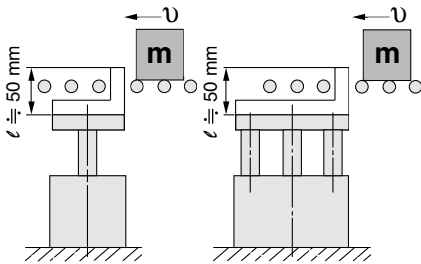

\* When selecting a model with a longer  $l$  dimension, be sure to choose a sufficiently large bore size.

### ⚠ Caution Caution on handling

Note) When using as a stopper  
 Bore size  $\phi 20$  and  $\phi 25$ : Select a model with  $\phi 30$  strokes or less.  
 Bore size  $\phi 32$  to  $\phi 63$ : Select a model with  $\phi 50$  strokes or less.

### Bore size $\phi 20$ and $\phi 25$

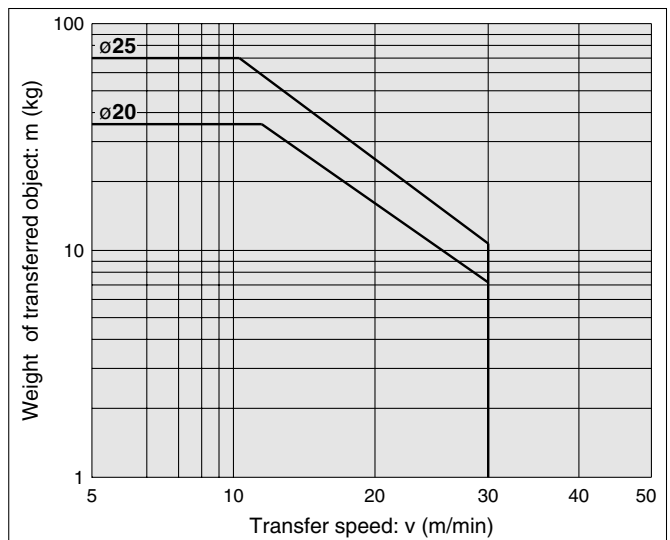

### Bore size $\phi 32$ to $\phi 63$

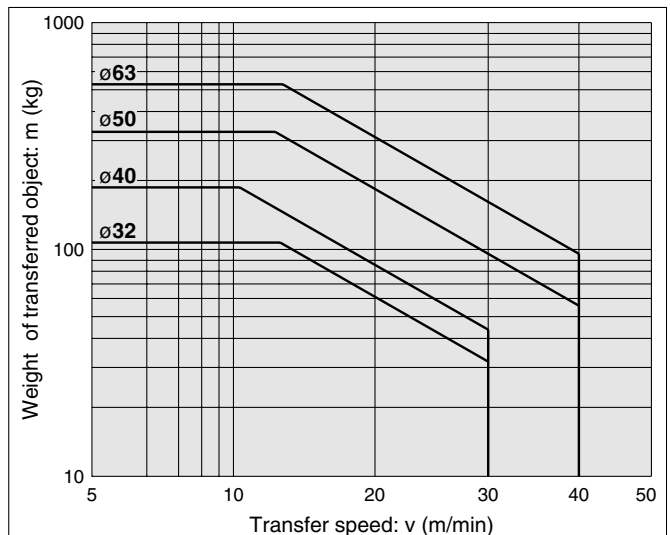

## Construction

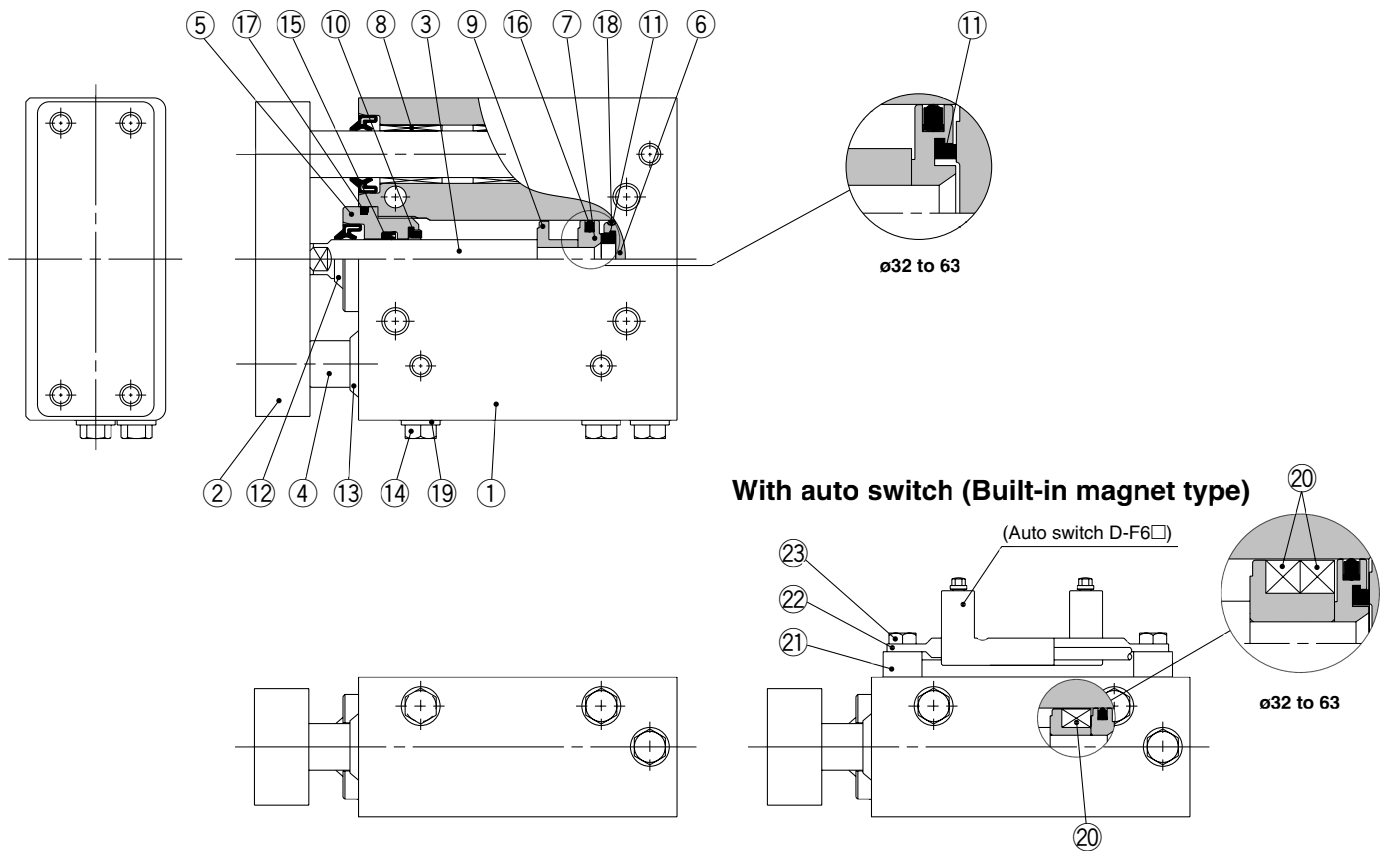

### Component Parts

No.	Description	Material	Qty.	Note
1	Body	Aluminum alloy	1	Anodic oxide film
2	Plate	Aluminum alloy	1	Anodic oxide film
3	Piston rod	Stainless steel	1	Hard chromium plated
4	Guide rod	Stainless steel	2	Special coated
5	Rod cover	Aluminum alloy	1	Anodic oxide film
6	Head cover	Aluminum alloy	1	Chromated
7	Piston	Aluminum alloy	1	Chromated
8	Bushing	Stainless steel	4	Special coated
9	Magnet holder	Aluminum alloy	1	Chromated
10	Bumper A	Resin	1	
11	Bumper B	Resin	1	
12	Scraper (Piston rod)	Stainless steel+NBR	1	(FKM can be selected.)
13	Scraper (Guide rod)	Stainless steel+NBR	2	(FKM can be selected.)
14	Hexagon bolt	Stainless steel	3	(Over ø32: 2 plugs and 1 hexagon bolt)
15	Rod seal	NBR	1	(FKM can be selected.)
16	Piston seal	NBR	1	
17	O-ring (Rod end)	NBR	1	(FKM can be selected.)
18	O-ring (Head end)	NBR	1	
19	Seal washer	Stainless steel+NBR	3	(FKM can be selected.)
20	Magnet	Resin	1	(Only built-in magnet) (Over ø32: 2 magnets)
21	Switch rail base	Stainless steel	2	(Only built-in magnet)
22	Switch rail	Stainless steel	1	(Only built-in magnet)
23	Hexagon bolt	Stainless steel	2	(Only built-in magnet)

### Replacement Parts: Seal Kit

Bore size	Part no.	Set contents
20	HYG20□-PS	15 Rod seal (1 pc.) 16 Piston seal (1 pc.)
25	HYG25□-PS	17 O-ring (Rod end) (1 pc.) 19 Seal washer (3 pcs.)
32	HYG32□-PS	15 Rod seal (1 pc.) 16 Piston seal (1 pc.)
40	HYG40□-PS	17 O-ring (Rod end) (1 pc.) 19 Seal washer (Breathing port for guide) (1 pc.)
50	HYG50□-PS	
63	HYG63□-PS	19 Seal washer (cylinder port) (2 pcs.)

Place the seal material symbol in □.

Symbol	Material
R	NBR
H	External FKM*

\* External seal. Rod seal, O-ring (Rod side) and seal washer are made from FKM.

**Grease package (Food compatible grease): GR-H-010 (10 g)**  
**(Standard grease): GR-S-010 (10 g)**

### ⚠ Caution

**Please contact SMC to repair or replace seals of cylinder bore size 40 mm and above.**

Please contact SMC when the cylinder has to be disassembled for the purpose of replacing seals, etc.

## Dimensions $\varnothing 20, \varnothing 25$

Without auto switch: HYG20, 25

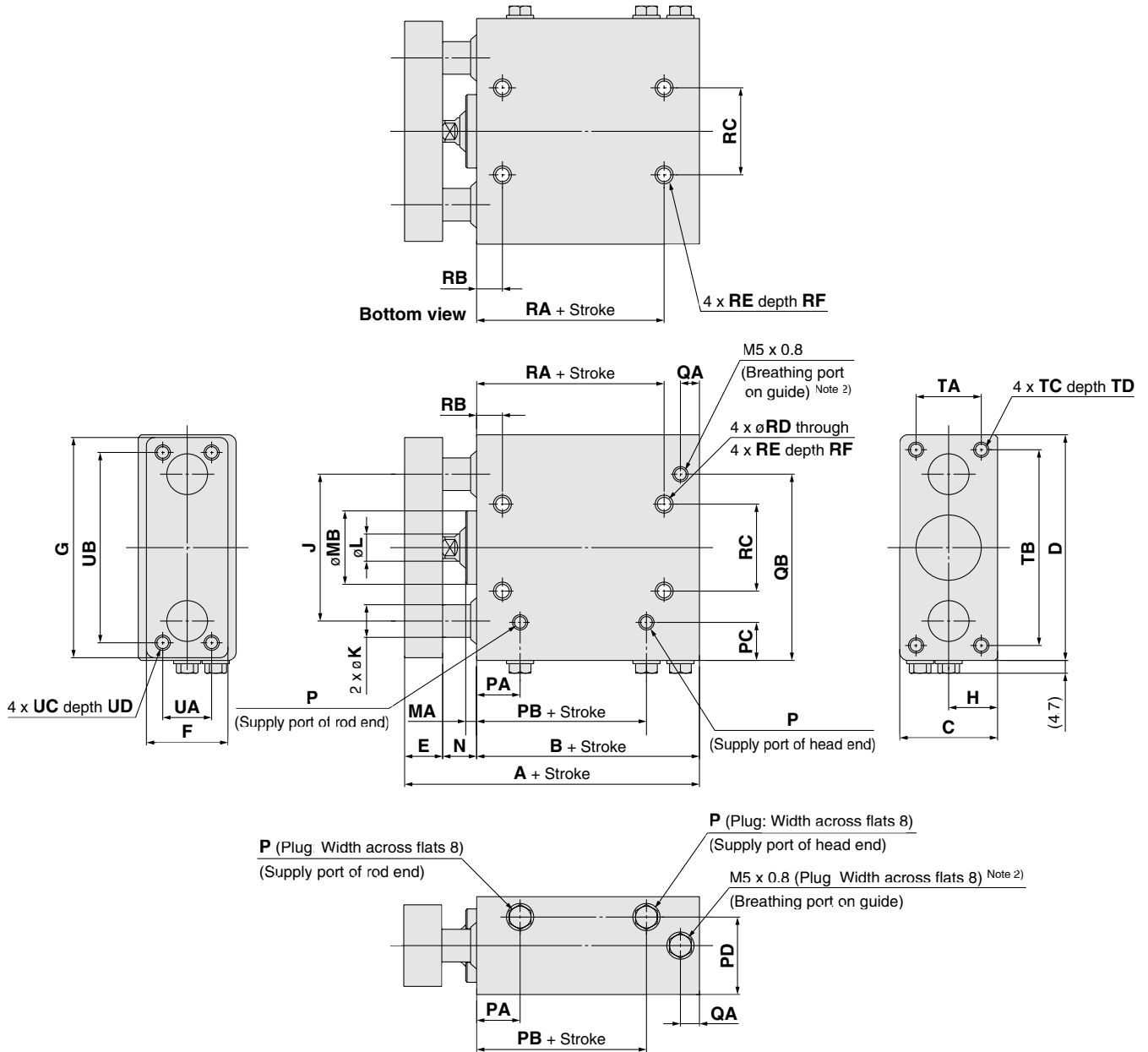

Bore size	Standard stroke	A				B				C	D	E	F	G	H	J	K	L	MA	MB	N	P	PA
		30 st or less	31 to 50 st	51 to 100 st	Over 101 st	30 st or less	31 to 50 st	51 to 100 st	Over 101 st														
20	20, 30, 50, 100,	78.5	88.5	108.5	128.5	52	62	82	102	36	83	14	30	81	18	54	12	10	4	27	12.5	M5 x 0.8	1 <sup>r</sup>
25	150, 200	86	96	116	136	56.5	66.5	86.5	106.5	42	93	16	38	91	21	64	16	12	4.5	32	13.5	M5 x 0.8	18

Bore size	PB	PC	PD	QA	QB	RA	RB	RC	RD	RE	RF	TA	TB	TC	TD	UA	UB	UC	UD
20	32.5	14	28.5	7	68.5	39	9.5	32	5.4	M6 x 1	12	24	72	M5 x 0.8	13	18	70	M5 x 0.8	1 <sup>r</sup>
25	34.5	15	34	8.5	78.5	41.5	9.5	38	5.4	M6 x 1	12	29	80	M6 x 1	14.5	26	78	M6 x 1	12

Note 1) Refer to page 35 for details about the optional parts (plug bolt).

Note 2) For piping, refer to Specific Product Precautions.

# Series HYG

## Dimensions $\varnothing 20, \varnothing 25$

With auto switch HYDG20, 25

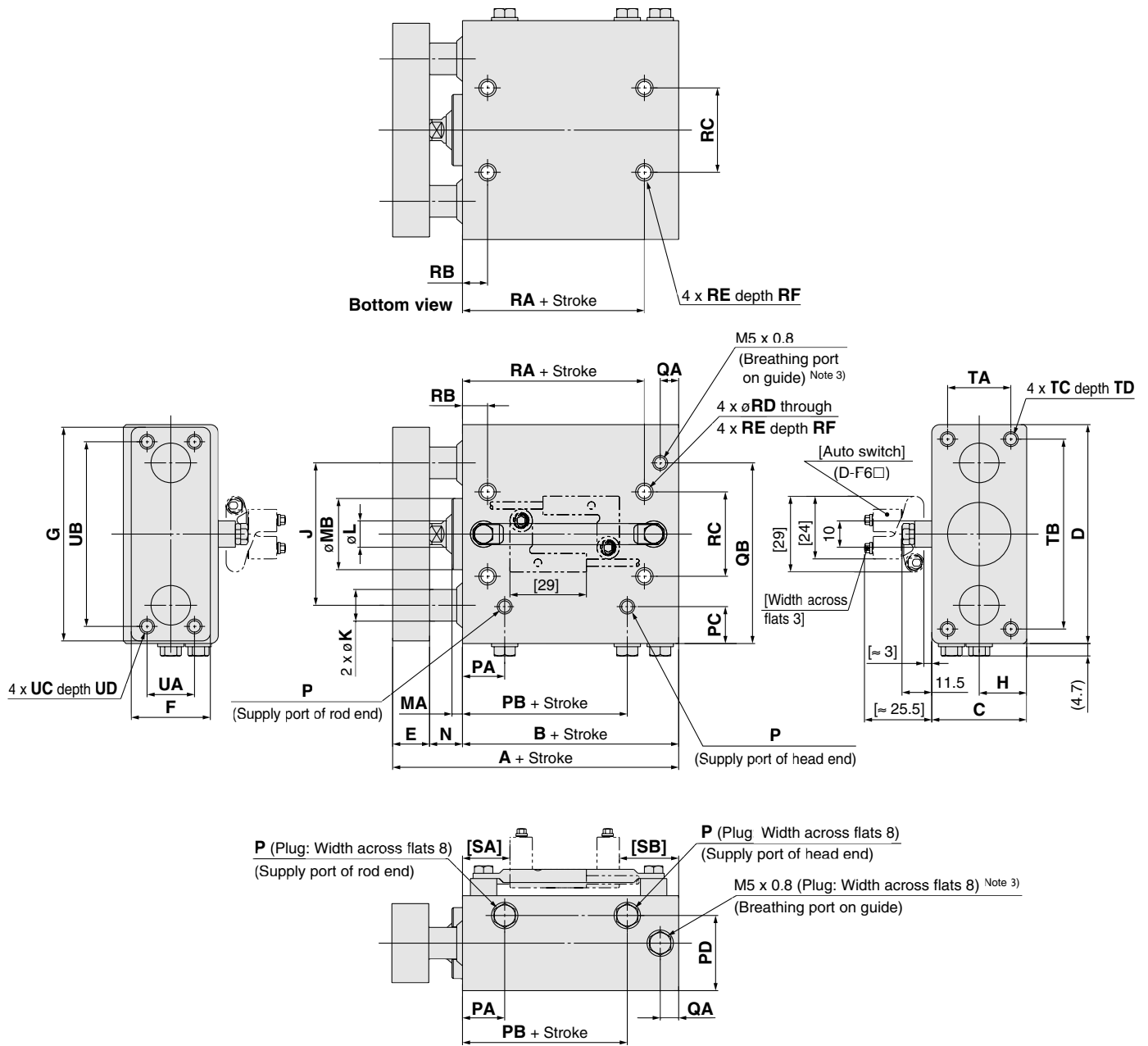

Bore size	Standard stroke	A				B				C	D	E	F	G	H	J	K	L	MA	MB	N	P	PA
		30 st or less	31 to 50 st	51 to 100 st	Over 101 st	30 st or less	31 to 50 st	51 to 100 st	Over 101 st														
20	20, 30, 50, 100,	78.5	88.5	108.5	128.5	52	62	82	102	36	83	14	30	81	18	54	12	10	4	27	12.5	M5 x 0.8	1 <sup>o</sup>
25	150, 200	86	96	116	136	56.5	66.5	86.5	106.5	42	93	16	38	91	21	64	16	12	4.5	32	13.5	M5 x 0.8	18

Bore size	PB	PC	PD	QA	QB	RA	RB	RC	RD	RE	RF	SA	SB				TA	TB	TC	TD	UA	UB	UC	UD
													30 st or less	31 to 50 st	51 to 100 st	Over 101 st								
20	32.5	14	28.5	7	68.5	39	9.5	32	5.4	M6 x 1	12	16	22.5	32.5	52.5	72.5	24	72	M5 x 0.8	13	18	70	M5 x 0.8	1 <sup>o</sup>
25	34.5	15	34	8.5	78.5	41.5	9.5	38	5.4	M6 x 1	12	17	25.5	35.5	55.5	75.5	29	80	M6 x 1	14.5	26	78	M6 x 1	12

Note 1) The [ ] value denotes dimensions with the auto switch D-F6□ mounted, which is dedicated to the Hygienic Design Cylinder.

Note 2) Refer to page 35 for details about the optional parts (plug bolt).

Note 3) For piping, refer to Specific Product Precautions.



## Dimensions $\varnothing 32$ to $\varnothing 63$

Without auto switch: HYG32 to 63

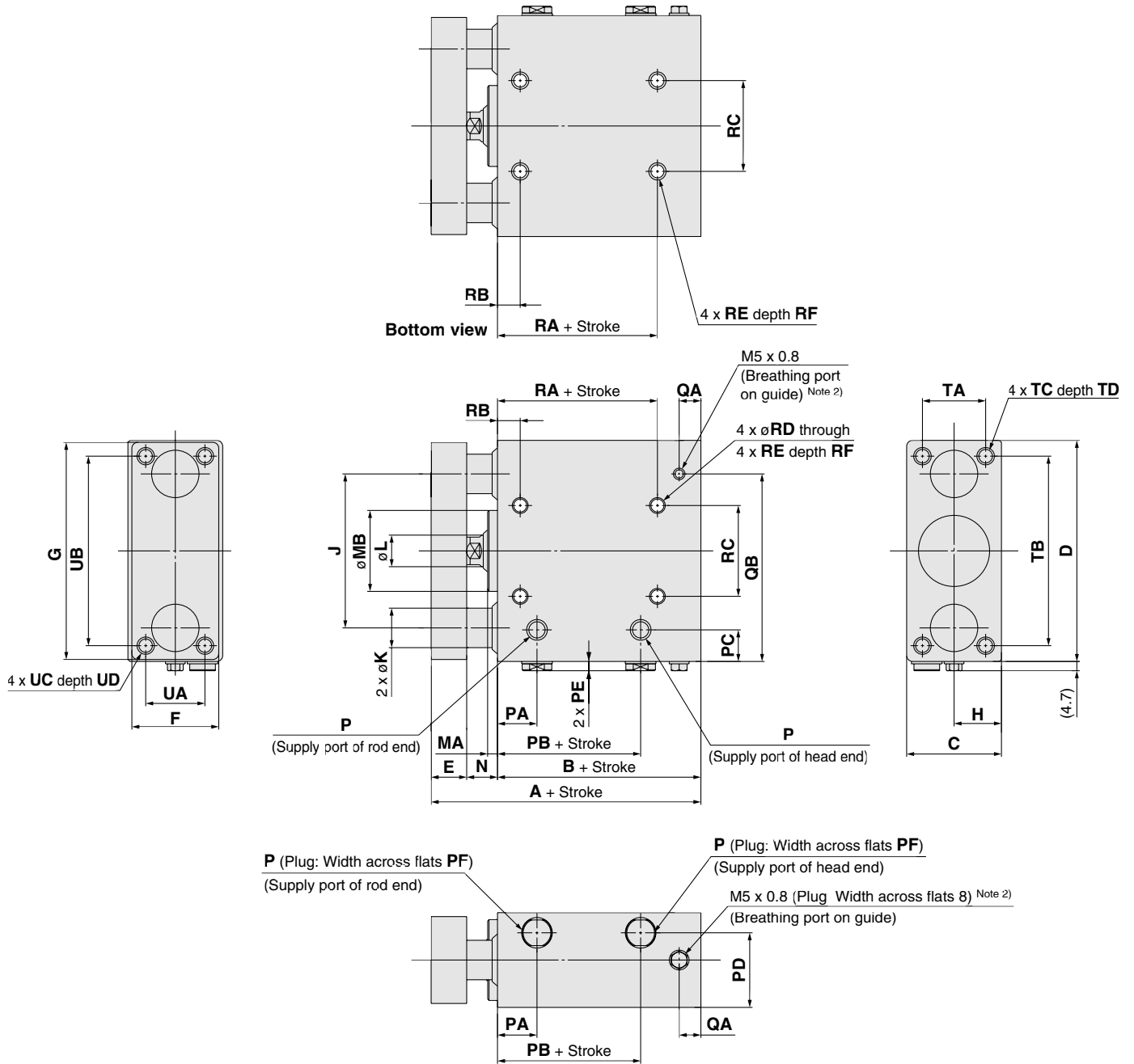

Bore size	Stroke	A				B				C	D	E	F	G	H	J	K	L	MA	MB	N
		30 st or less	31 to 50 st	51 to 100 st	Over 101 st	30 st or less	31 to 50 st	51 to 100 st	Over 101 st												
32	25, 50, 100, 150, 200	106.5	116.5	131.5	146.5	73	83	98	113	48	112	18	44	110	24	78	20	16	5	41	15.5
40		106.5	116.5	131.5	146.5	73	83	98	113	54	120	18	44	118	27	86	20	16	5	48	15.5
50		121.5	131.5	146.5	161.5	80	90	105	120	64	148	23	60	146	32	110	25	20	6	59	18.5
63		121.5	131.5	146.5	161.5	80	90	105	120	78	162	23	70	158	39	124	25	20	6	74	18.5

Bore size	P			PA	PB	PC	PD	PE	PF	QA	QB	RA	RB	RC	RD	RE	RF	TA	TB	TC	TD	UA	UB	UC	UD
	Nil	TF	TN																						
32	Rc1/8	G1/8	NPT1/8	20	42.5	16	37.8	4.7	13	11	95	51	11.5	46	6.6	M8 x 1.25	16	32	96	M8 x 1.25	20	30	96	M8 x 1.25	13.5
40	Rc1/8	G1/8	NPT1/8	20.5	40.5	17	42.5	4.7	13	11	103	31	30	50	6.6	M8 x 1.25	16	38	104	M8 x 1.25	20	30	104	M8 x 1.25	13.5
50	Rc1/4	G1/4	NPT1/4	22	41.5	22	52	6.2	16	12.5	129	31	32	63	8.6	M10 x 1.5	20	43	127	M10 x 1.5	22	40	130	M10 x 1.5	17
63	Rc1/4	G1/4	NPT1/4	24	45	23	61	6.2	16	12	143	35	34	76	8.6	M10 x 1.5	20	57	141	M10 x 1.5	22	50	130	M10 x 1.5	17

Note 1) Refer to page 35 for details about the optional parts (plug bolt).

Note 2) For piping, refer to Specific Product Precautions.

# Series HYG

## Dimensions $\varnothing 32$ to $\varnothing 63$

With auto switch HYDG32 to 63

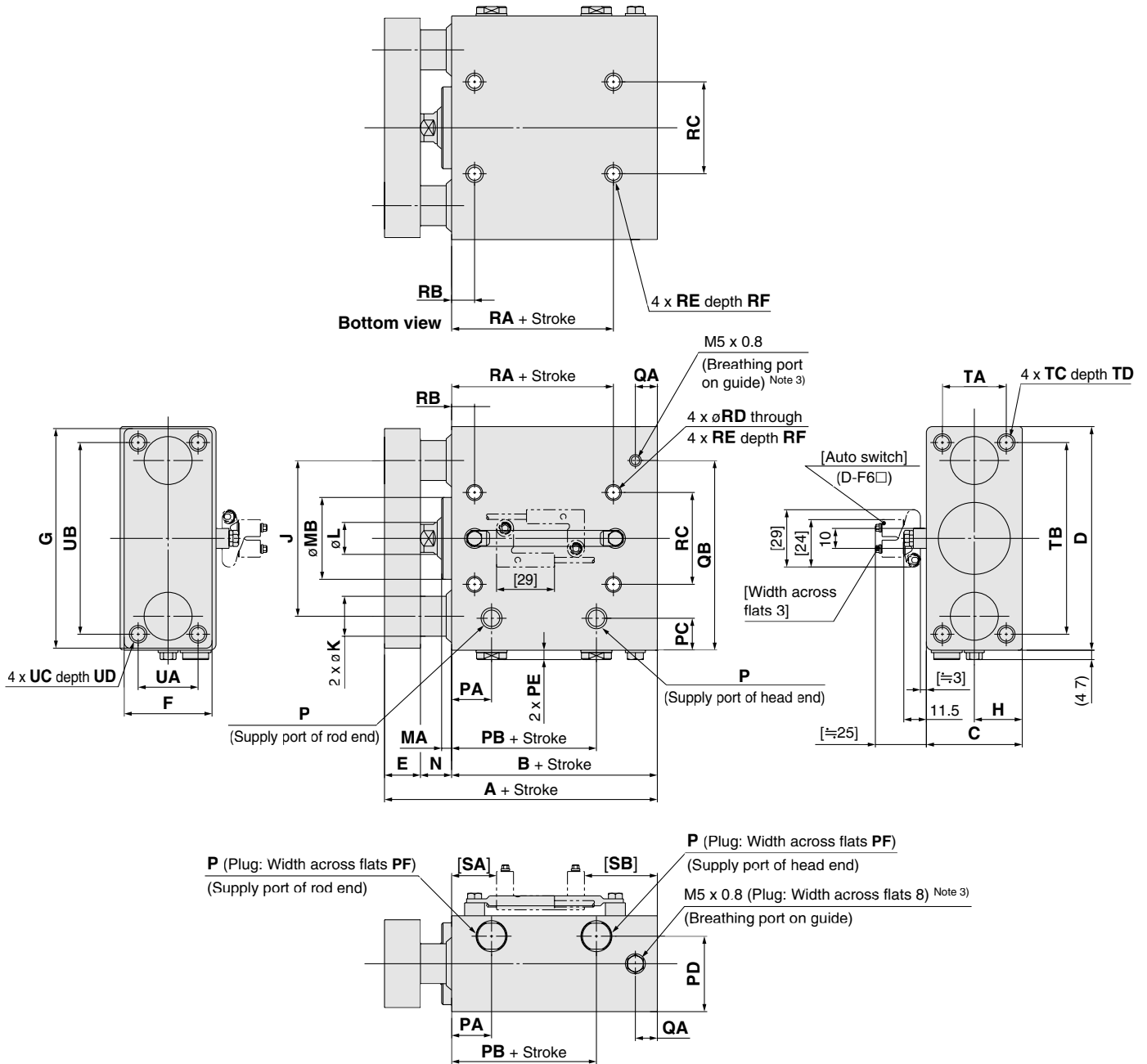

(mm)

Bore size	Stroke	A				B				C	D	E	F	G	H	J	K	L	MA	MB	N	P			PA
		30 st or less	31 to 50 st	51 to 100 st	Over 101 st	30 st or less	31 to 50 st	51 to 100 st	Over 101 st													Nil	TF	TN	
<b>32</b>	25, 50, 100, 150, 200	106.5	116.5	131.5	146.5	73	83	98	113	48	112	18	44	110	24	78	20	16	5	41	15.5	Rc1/8	G1/8	NPT1/8	20
<b>40</b>		106.5	116.5	131.5	146.5	73	83	98	113	54	120	18	44	118	27	86	20	16	5	48	15.5	Rc1/8	G1/8	NPT1/8	20.5
<b>50</b>		121.5	131.5	146.5	161.5	80	90	105	120	64	148	23	60	146	32	110	25	20	6	59	18.5	Rc1/4	G1/4	NPT1/4	22
<b>63</b>		121.5	131.5	146.5	161.5	80	90	105	120	78	162	23	70	158	39	124	25	20	6	74	18.5	Rc1/4	G1/4	NPT1/4	24

Bore size	PB	PC	PD	PE	PF	QA	QB	RA	RB	RC	RD	RE	RF	SA	SB				TA	TB	TC	TD	UA	UB	UC	UD
															30 st or less	31 to 50 st	51 to 100 st	Over 101 st								
<b>32</b>	42.5	16	37.8	4.7	13	11	95	51	11.5	46	6.6	M8 x 1.25	16	22.5	36.5	46.5	61.5	76.5	32	96	M8 x 1.25	20	30	96	M8 x 1.25	13.5
<b>40</b>	40.5	17	42.5	4.7	13	11	103	31	30	50	6.6	M8 x 1.25	16	21	38	48	63	78	38	104	M8 x 1.25	20	30	104	M8 x 1.25	13.5
<b>50</b>	41.5	22	52	6.2	16	12.5	129	31	32	63	8.6	M10 x 1.5	20	21	45	55	70	85	43	127	M10 x 1.5	22	40	130	M10 x 1.5	17
<b>63</b>	45	23	61	6.2	16	12	143	35	34	76	8.6	M10 x 1.5	20	23.5	42.5	52.5	67.5	82.5	57	141	M10 x 1.5	22	50	130	M10 x 1.5	17

Note 1) The [ ] value denotes dimensions with the auto switch D-F6□ mounted, which is dedicated to the Hygienic Design Cylinder.

Note 2) Refer to page 35 for details about the optional parts (plug bolt).

Note 3) For piping, refer to Specific Product Precautions.

## Auto Switch Proper Mounting Position (Detection at stroke end) and Its Mounting Height

### HYQ

#### D-F6

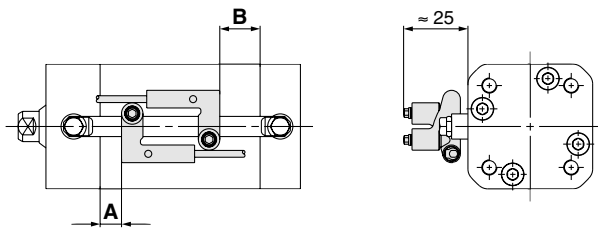

Bore size	(mm)	
	A	B
20	6.5	10.5
25	6.5	11
32	8.5	16
40	10.5	16
50	10.5	17
63	9	18

Note) The above values are a guide in the stroke end detection of the mounting position of the auto switch. Please adjust in an actual setting after confirming the operating state of the auto switch.

### HYC

#### D-F6

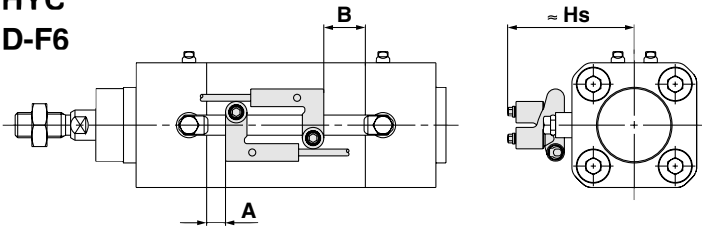

Bore size	(mm)		
	A	B	Hs
32	7.5	16.5	50
40	12	23	54
50	9	19	60
63	19	24	67

Note) The above values are a guide in the stroke end detection of the mounting position of the auto switch. Please adjust in an actual setting after confirming the operating state of the auto switch.

### HYG

#### D-F6

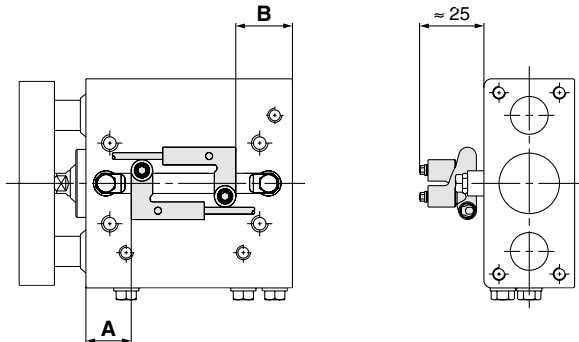

Bore size	A	(mm)			
		B			
		30 st or less	31 to 50 st	51 to 100 st	Over 101 st
20	16	22.5	32.5	52.5	72.5
25	17	25.5	35.5	55.5	75.5
32	22.5	36.5	46.5	61.5	76.5
40	21	38	48	63	78
50	21	45	55	70	85
63	23.5	42.5	52.5	67.5	82.5

Note) The above values are a guide in the stroke end detection of the mounting position of the auto switch. Please adjust in an actual setting after confirming the operating state of the auto switch.

## Operating Range

Unit: Operating range [mm]

Auto switch model	Series	Bore size					
		20	25	32	40	50	63
D-F6	HYQ	7	6	7.5	7.5	7.5	7.5
	HYC	—	—	7.5	7.5	7.5	7.5
	HYG	7	7	8	7.5	7.5	7.5

Note) Since this is a guideline including hysteresis, it is not meant to be guaranteed. There may be substantial variation depending on the surrounding environment (assuming approximately ±50% dispersion).

## Minimum Stroke of Auto Switch Mounting

Auto switch model	Series	1 pc.	2 pcs.
D-F6	HYQ, HYC	5	10
	HYG	10	15

## Auto Switch Mounting (HYQ, HYC, HYG common)

### Proper tightening torque

When the mounting screw is tightened, use a special tool or torque wrench. The tightening torque of the M3 mounting screw should be 0.8 to 1.4 N·m.

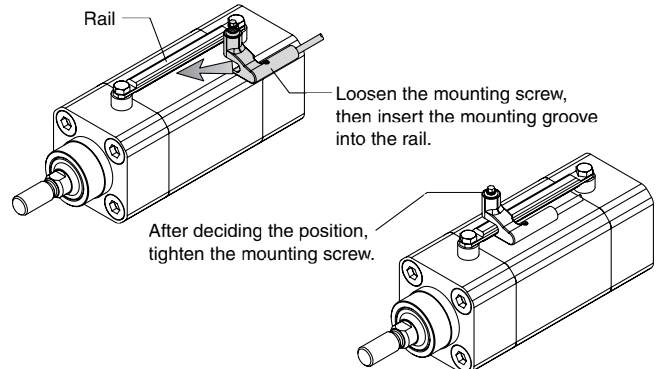

Tighten the screw within the following torque range when the auto switch mounting rail is installed during maintenance.

Screw size	Tightening torque (N·m)
M4	1.1 to 1.9

Tighten the screw within the following torque range when the auto switch is installed on the mounting rail.

Tightening torque (N·m)
0.8 to 1.4

# Mounting Brackets

## Foot Bracket

### HYB

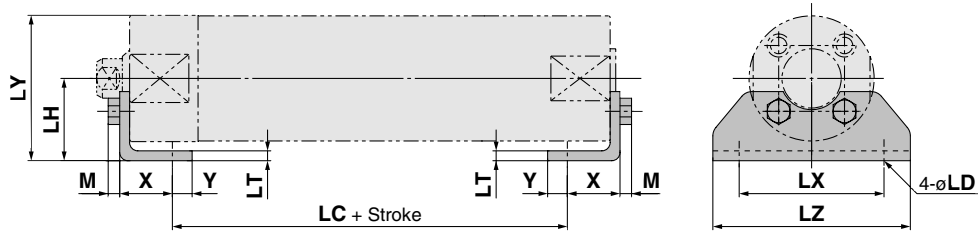

Foot bracket material: Stainless steel

Bore size	Bracket part no.	Weight (g)	X	Y	LD	LH	LC	LT	LX	LY	LZ	M	Mounting bolt
32	CG-L032SUS	0.06	16	6	7.2	25	45	3	44	44	60	3.5	M5 x 0.8
40	CG-L040SUS	0.08	16.5	6.5	7.2	30	51	3	54	53.5	75	4	M6 x 1.0
50	CG-L050SUS	0.17	21.5	11.5	10	40	55	4	66	69	90	5.5	M8 x 1.25
63	CG-L063SUS	0.23	21.5	11.5	12	45	55	4	82	81	110	7	M10 x 1.5
80	CG-L080SUS	0.36	28	17	12	55	60	4	100	99.5	130	7	M10 x 1.5
100	CG-L100SUS	0.69	30	15	14	70	60	6	120	125	160	8	M12 x 1.75

Note 1) One mounting bracket is attached with one foot bracket and two mounting bolts.

Note 2) Order two foot brackets per cylinder.

Note 3) Contact SMC for HYB ø20, ø25.

### HYC

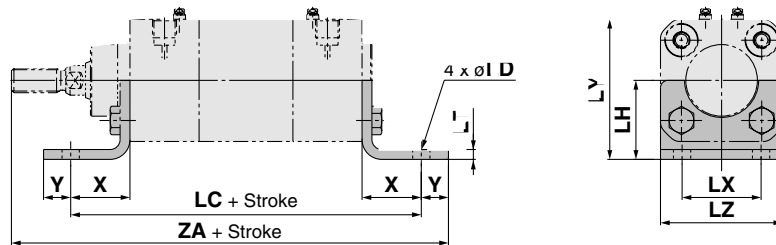

### HYQ

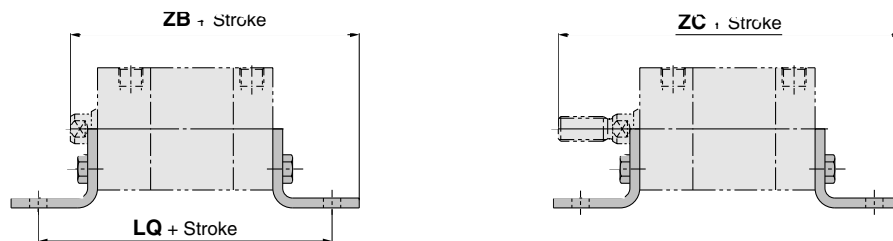

Foot bracket material: Stainless steel (mm)

Bore size	Bracket part no.	Weight (g)	X	Y	LD	LH	LC	LQ	LT	LX	LY	LZ	HYC		HYQ Without auto switch		HYDQ With auto switch		Mounting bolt
													ZA	ZB	ZC	ZB	ZC		
32	HY-L032SUS	100	24	11	7	32	142	109	4	32	57	49.5	177	107	129	122	144	M6 x 1 x 18L	
40	HY-L040SUS	120	28	10	9	36	161	121.5	4	36	65	57.5	198	115.5	139.5	130.5	154.5	M6 x 1 x 18L	
50	HY-L050SUS	210	32	11	9	45	170	140.5	5	45	80	69	218	133.5	165.5	148.5	180.5	M8 x 1.25 x 20L	
63	HY-L063SUS	260	32	11	9	50	185	141	5	50	92	84	233	134	166	149	181	M8 x 1.25 x 20L	

Note 1) One mounting bracket is attached with one foot bracket and two mounting bolts.

Note 2) Two foot brackets per cylinder should be ordered.

Note 3) Contact SMC for HYQ ø20, ø25.

## Flange Bracket

### HYB (Rod end)

Rod end flange bracket (Material: Stainless steel)

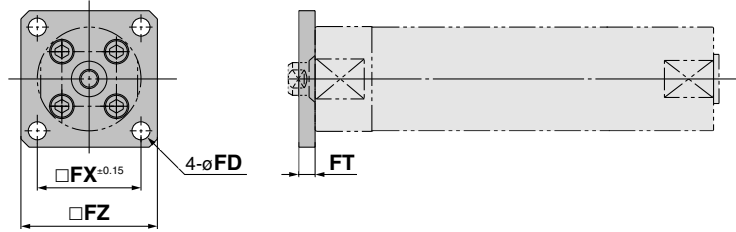

Flange bracket material: Stainless steel

Bore size	Bracket part no.	Weight (g)	FT	FX	FZ	FD
32	CG-F032SUS	0.10	6	38	50	6.6
40	CG-F040SUS	0.15	6	46	60	6.6
50	CG-F050SUS	0.26	9	58	75	9
63	CG-F063SUS	0.52	9	70	90	11
80	CG-F080SUS	0.66	9	82	100	11
100	CG-F100SUS	1.16	10	100	125	14

Note 1) One mounting bracket is attached with one flange bracket and four mounting bolts.

Note 2) Contact SMC for HYB  $\phi 20$ ,  $\phi 25$ .

### HYC (Rod end and head end are common.)

### HYQ

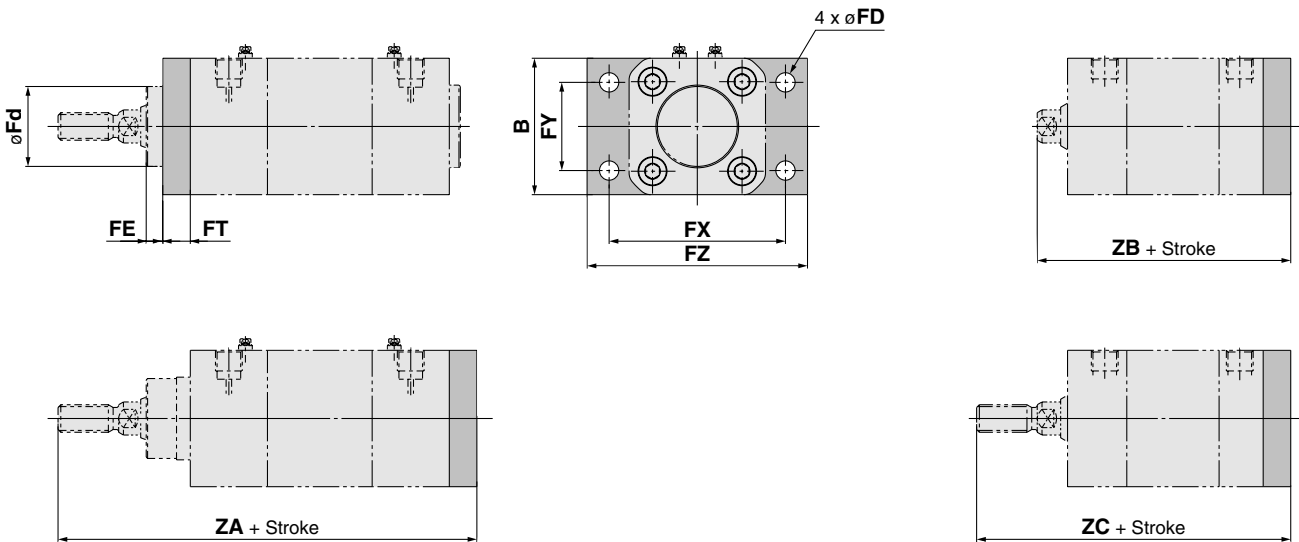

Flange bracket material: Stainless steel (mm)

Bore size	Bracket part no.	Weight (g)	B	FD	FE	FT	FX	FY	FZ	Fd	HYC		HYQ		HYDQ		Mounting bolt
											ZA	ZB	Without auto switch	With auto switch	ZB	ZC	
32	HY-F032SUS	260	49.5	7	6	10	64	32	80	29	152	82	104	97	119	M6 x 1 x 18L	
40	HY-F040SUS	320	57.5	9	8.5	10	72	36	90	34	169	87.5	111.5	102.5	126.5	M6 x 1 x 18L	
50	HY-F050SUS	580	69	9	11	12	90	45	110	39	187	102.5	134.5	117.5	149.5	M8 x 1.25 x 20L	
63	HY-F063SUS	770	82	9	11	12	100	50	120	44	202	103	135	118	150	M8 x 1.25 x 20L	

Note 1) One mounting bracket is attached with 4 mounting bolts

Note 2) Contact SMC for HYQ  $\phi 20$ ,  $\phi 25$ .

## Single Clevis Bracket

### HYC

Single clevis bracket material: Stainless steel  
(mm)

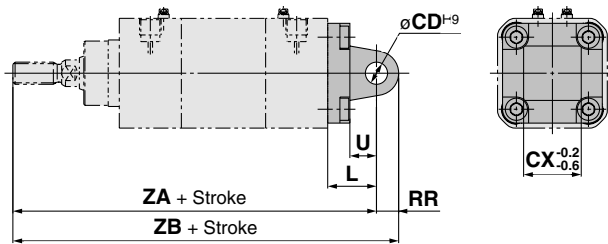

Bore size	Bracket part no.	Weight (g)	L	RR	U	CD <sup>H9</sup>	CX <sup>-0.2</sup> <sub>-0.6</sub>	HYC	
								ZA	ZB
32	HY-C032SUS	200	22	10	12	10	26	164	174
40	HY-C040SUS	310	25	12	15	12	28	184	196
50	HY-C050SUS	440	27	12	17	12	32	202	214
63	HY-C063SUS	760	32	16	20	16	40	222	238

### HYQ

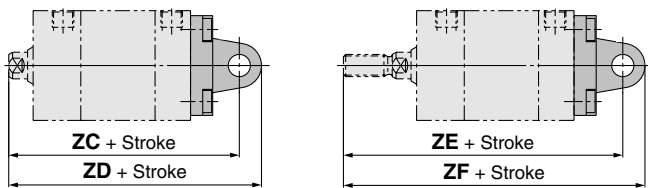

Bore size	Bracket part no.	HYQ / without auto switch			
		ZC	ZD	ZE	ZF
32	HY-C032SUS	94	104	116	126
40	HY-C040SUS	102.5	114.5	126.5	138.5
50	HY-C050SUS	117.5	129.5	149.5	161.5
63	HY-C063SUS	123	139	155	171

Bore size	Bracket part no.	HYDQ / with auto switch				Mounting bolt
		ZC	ZD	ZE	ZF	
32	HY-C032SUS	109	119	131	141	M6 x 1 x 18L
40	HY-C040SUS	117.5	129.5	141.5	153.5	M6 x 1 x 18L
50	HY-C050SUS	132.5	144.5	164.5	176.5	M8 x 1.25 x 20L
63	HY-C063SUS	138	154	170	186	M8 x 1.25 x 20L

Note 1) One mounting bracket is attached with 4 mounting bolts.  
Note 2) Contact SMC for HYQ  $\phi 20$ ,  $\phi 25$ .

## Double Clevis Bracket

### HYC

Double clevis bracket material: Stainless steel  
(mm)

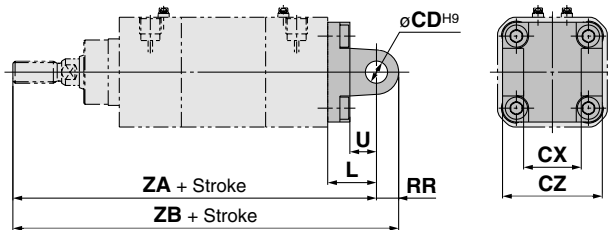

Bore size	Bracket part no.	Weight (g)	L	RR	U	CD <sup>H9</sup>	CX <sup>H14</sup>	CZ <sup>H14</sup>
40	HY-D040SUS	350	25	12	15	12	28	52
50	HY-D050SUS	490	27	12	17	12	32	60
63	HY-D063SUS	810	32	16	20	16	40	70

Bore size	Bracket part no.	HYC		HYQ / without auto switch			
		ZA	ZB	ZC	ZD	ZE	ZF
32	HY-D032SUS	164	174	94	104	116	126
40	HY-D040SUS	184	196	102.5	114.5	126.5	138.5
50	HY-D050SUS	202	214	117.5	129.5	149.5	161.5
63	HY-D063SUS	222	238	123	139	155	171

### HYQ

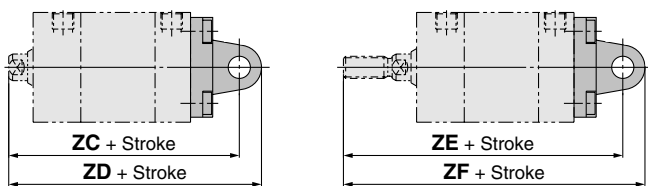

Bore size	Bracket part no.	HYDQ / with auto switch				Mounting bolt
		ZC	ZD	ZE	ZF	
32	HY-D032SUS	109	119	131	141	M6 x x 18L
40	HY-D040SUS	117.5	129.5	141.5	153.5	M6 x 1 x 18L
50	HY-D050SUS	132.5	144.5	164.5	176.5	M8 x .25 x 20L
63	HY-D063SUS	138	154	170	186	M8 x 1.25 x 20L

Note 1) One mounting bracket is attached with 4 mounting bolts and clevis pin (HY-E0□SUS) and snap rings.  
Note 2) Contact SMC for HYQ  $\phi 20$ ,  $\phi 25$ .

## Clevis Pin

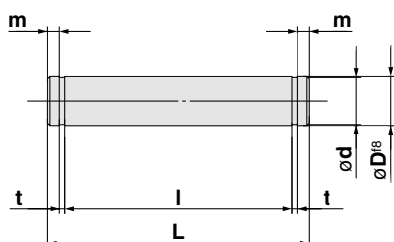

Material: Stainless steel  
(mm)

Bore size	Bracket part no.	Weight (g)	D <sup>H8</sup>	L	d	l	m	t	Applied snap ring
									C type for shaft 10
32	HY-E03SUS	40	10	53	9.6	46	2.3	1.2	C type for shaft 10
40	HY-E04SUS	60	12	60	11.5	53	2.3	1.2	C type for shaft 12
50	HY-E05SUS	70	12	68	11.5	61	2.3	1.2	C type for shaft 12
63	HY-E06SUS	130	16	78	15.2	71	2.3	1.2	C type for shaft 16

Note 1) One clevis pin is attached with two snap rings.  
Note 2) Contact SMC for HYQ  $\phi 20$ ,  $\phi 25$ .

# Options

## Rod End Nut

### HYQ, HYC

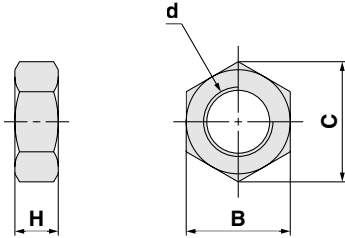

Material: Stainless steel  
(mm)

Part no.	Applicable bore size	d	H	B	C
NTH-02SUS	20	M6 x 1.0	3.6	10	11.5
NT-02SUS	25	M8 x 1.25	5	13	15
NT-03SUS	32	M10 x 1.25	6	17	19.6
NTH-04SUS	40	M12 x 1.25	7	19	21.9
NTH-05SUS	50, 63	M16 x 1.5	10	24	27.7

## Plug Bolt

### HYC

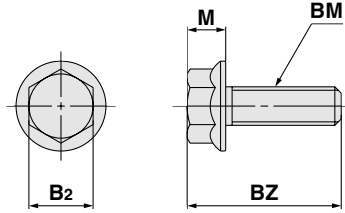

Material: Stainless steel  
(mm)

Part no.	Applicable bore size	B2	BM	BZ	M
HYC-H03SUS	32, 40	10	M6 x 1.0	22	6
HYC-H05SUS	50, 63	12	M8 x 1.25	24	8

Note) The above part number is attached with 4 bolts.

### HYB, HYG

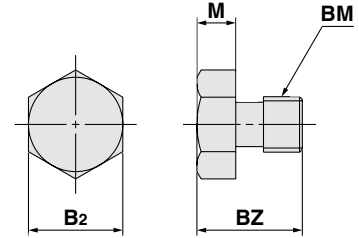

Material: Stainless steel  
(mm)

#### HYB

Part no.	Applicable bore size	B2	BM	BZ	M
HYB-H020SUS	20	7	M4 x 0.7	9	3
HYB-H025SUS	25	8	M5 x 0.8	9.5	3.5
	32	8	M5 x 0.8	9.5	3.5
HYB-H040SUS	40	10	M6 x 1.0	12	4
HYB-H050SUS	50	13	M8 x 1.25	15.5	5.5
HYB-H063SUS	63	17	M10 x 1.5	19	7
	80	17	M10 x 1.5	19	7
HYB-H100SUS	100	19	M12 x 1.75	24	8

Note) The above part number is attached with 4 bolts.

#### HYG

Part no.	B2	BM	BZ	M
HYG-H020SUS	8	M5 x 0.8	9.5	3.5
HYG-H025SUS	10	M6 x 1.0	12	4
HYG-H032SUS	13	M8 x 1.25	15.5	5.5
HYG-H050SUS	17	M10 x 1.5	19	7

Note) The above part number is attached with 4 bolts.

## External Cover

### HYQ: $\varnothing 20, \varnothing 25$

#### Rod end

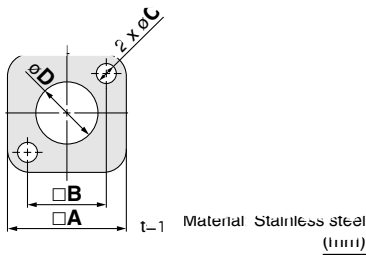

Part no.	A	B	C	D	Installation bolt
HYQ-HA020SUS	32.2	22	5.5	18.5	M5 x 0.8 x 10L
HYQ-HA025SUS	39.2	26	6.6	20.5	M6 x 1.0 x 10L

Note) One mounting bracket is attached with two mounting bolts.

#### Head end

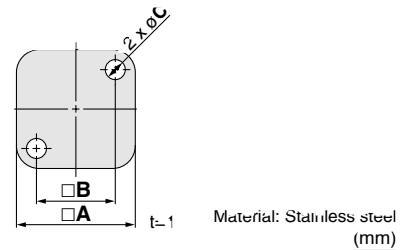

Part no.	A	B	C	Installation bolt
HYQ-HB020SUS	32.2	22	5.5	M5 x 0.8 x 10L
HYQ-HB025SUS	39.2	26	6.6	M6 x 1.0 x 10L

Note) One mounting bracket is attached with two mounting bolts.

### HYQ: $\varnothing 32$ to $\varnothing 63$

#### Rod end

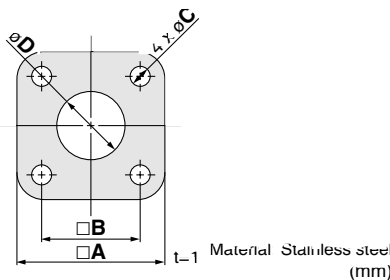

Part no.	A	B	C	D	Installation bolt
HYQ-HA032SUS	48.8	32.5	6.6	22.5	M6 x 1.0 x 10L
HYQ-HA040SUS	56.8	38	6.6	26.5	M6 x 1.0 x 10L
HYQ-HA050SUS	68.2	46.5	8.8	32.5	M8 x 1.25 x 10L
HYQ-HA063SUS	83.2	56.5	8.8	32.5	M8 x 1.25 x 10L

Note) One mounting bracket is attached with four mounting bolts.

#### Head end

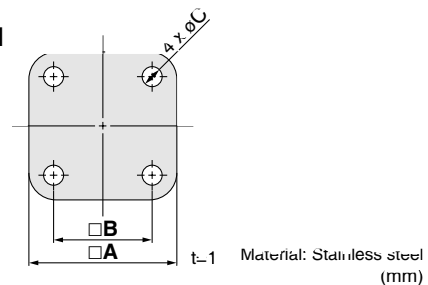

Part no.	A	B	C	Installation bolt
HYQ-HB032SUS	48.8	32.5	6.6	M6 x 1.0 x 10L
HYQ-HB040SUS	56.8	38	6.6	M6 x 1.0 x 10L
HYQ-HB050SUS	68.2	46.5	8.8	M8 x 1.25 x 10L
HYQ-HB063SUS	83.2	56.5	8.8	M8 x 1.25 x 10L

Note) One mounting bracket is attached with four mounting bolts.

# Auto Switch Specifications

## Specifications

Type	Solid state switch
<b>Leakage current</b>	3-wire: 100 $\mu$ A or less 2-wire: 0.8 mA or less
<b>Operating time</b>	1 ms or less
<b>Impact resistance</b>	1000 m/s <sup>2</sup>
<b>Insulation resistance</b>	50 M $\Omega$ or more at 500 VDC Mega (between lead wire and case)
<b>Withstand voltage</b>	1000 VAC for 1 minute (between lead wire and case)
<b>Ambient temperature</b>	-10 to 60°C
<b>Enclosure</b>	IEC529 standard IP67, JIS C 0920 waterproof construction

## Hysteresis

Hysteresis is the distance between the position at which piston movement operates an auto switch and the position at which reverse movement turns the switch off. This hysteresis is included in a part of the operating range (one side)

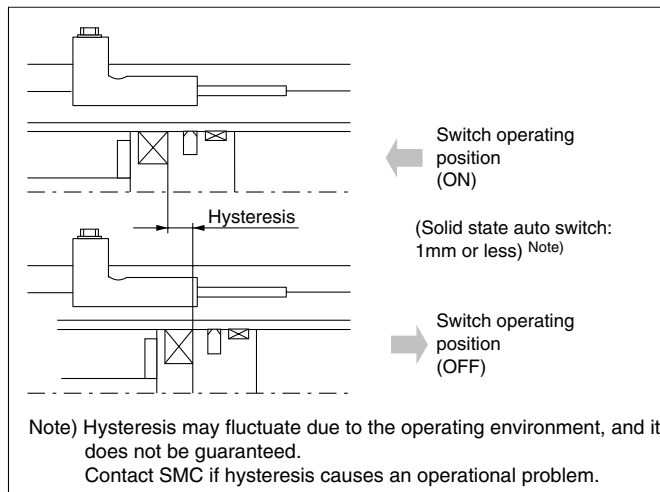

## Lead Wire Length

Lead wire length indication

(Example) D-F6P L

L

Lead wire length

Nil	0.5 m
L	3 m
Z	5 m

Note 1) Applicable auto switch with 5 m lead wire "Z"

Solid state switch: All types are manufactured upon receipt of order (as standard).

Note 2) The standard lead wire length of solid state switch with water resistant 2-color indication is 3 meters. (0.5 m is not available.)



# Series HY   Auto Switch Connections and Examples

## Basic Wiring

### Solid state 3-wire, NPN

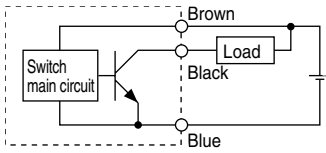

(The switch power supply and the load power supply are another cases )

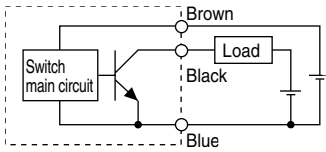

### Solid state 3-wire, PNP

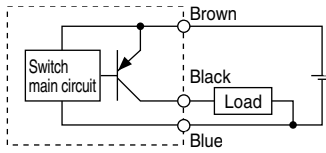

### 2-wire (Solid state)

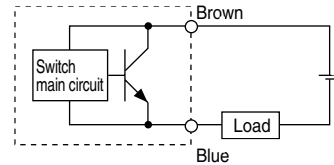
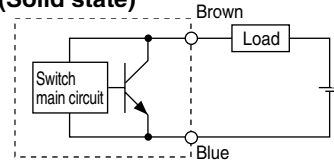

## Example of Connection to PLC

### • Sink input specifications 3-wire, NPN

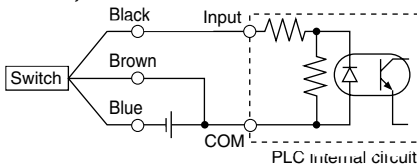

### • Source input specifications 3-wire, PNP

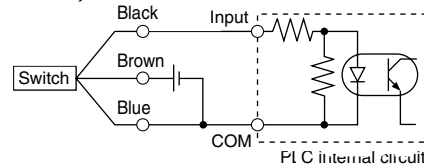

Connect according to the applicable PLC input specifications, since the connection method will vary depending on the PLC input specifications.

### 2-wire

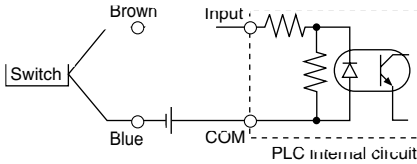

### 2-wire

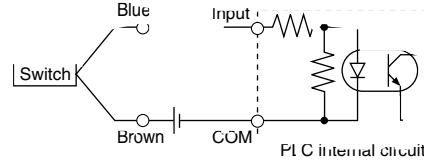

## Example of AND (Series) and OR (Parallel) Connection

### • 3-wire

#### AND connection for NPN output (using relays)

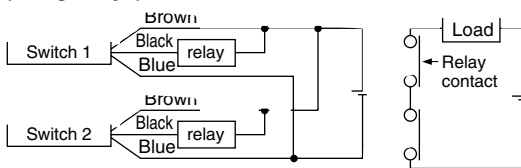

#### AND connection for NPN output (performed with switches only)

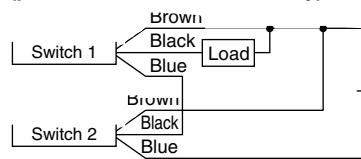

#### OR connection for NPN output

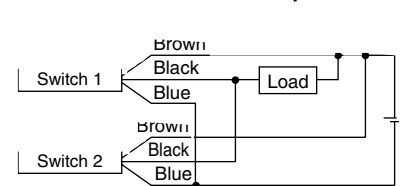

The indicator lights will illuminate when both switches are turned ON.

#### 2-wire with 2 switches AND connection

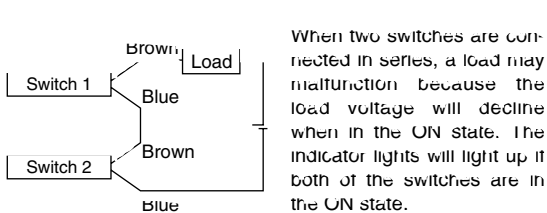

When two switches are connected in series, a load may malfunction because the load voltage will decline when in the ON state. The indicator lights will light up if both of the switches are in the ON state.

$$\begin{aligned} \text{Load voltage at ON} &= \text{Power supply voltage} - \text{Internal voltage drop} \times 2 \text{ pcs.} \\ &= 24 \text{ V} - 4 \text{ V} \times 2 \text{ pcs.} \\ &= 16 \text{ V} \end{aligned}$$

Example : Power supply voltage is 24 V DC  
Internal voltage drop in switch is 4 v.

#### 2-wire with 2 switches OR connection

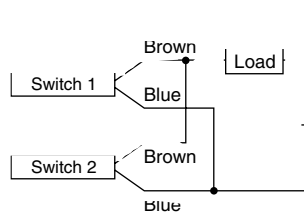

(Solid state)  
When two switches are connected in parallel, malfunction may occur because the load voltage will increase when in the OFF state.

$$\begin{aligned} \text{Load voltage at OFF} &= \text{Leakage current} \times 2 \text{ pcs.} \times \text{Load impedance} \\ &= \text{mA} \times 2 \text{ pcs.} \times 3 \text{ k}\Omega \\ &= 6 \text{ V} \end{aligned}$$

Example : Load impedance is 3 kΩ  
Leakage current from switch is 1 mA.

# Solid State Switch: Direct Mounting Style D-F6N/D-F6P/D-F6B



## Grommet

- 2-wire load current is reduced (2.5 to 40 mA)
- UL certified (style 2844) lead cable is used
- For RoHS



## Auto Switch Specifications

PLC: Programmable Logic Controller

D-F6□ (With indicator light)			
Auto switch part no.	D-F6N	D-F6P	D-F6B
Electrical entry direction	In-line		
Wiring type	3-wire		2-wire
Output type	NPN	PNP	—
Applicable load	IC circuit, relay, and PLC		24 VDC relay, PLC
Power supply voltage	5, 12, 24 VDC (4.5 to 28 V)		—
Current consumption	10 mA or less		—
Load voltage	28 VDC or less	—	24 VDC (10 to 28 VDC)
Load current	40 mA or less		2.5 to 40 mA
Internal voltage drop	0.8 V or less		4 V or less
Leakage current	100 μA or less at 24 V DC		0.8 mA or less
Indicator light	Red LED illuminates when ON.		

- Lead wires Oilproof vinyl heavy-duty cord: 2.7 x 3.2 ellipse  
D-F6B 0.15 mm<sup>2</sup> x 2 cores  
D-F6N, D-F6P: 0.15 mm<sup>2</sup> x 3 cores

Note 1) Refer to page 37 for solid state switch common specifications.

Note 2) Refer to page 37 for lead wire lengths.

## Caution

### Operating Precautions

Fix the switch with the existing screw installed on the switch body. The switch may be damaged if a screw other than the one supplied, is used.

## Weight

Unit g

Auto switch part no.	D-F6N	D-F6P	D-F6B
Lead wire length (m)	0.5	20	19
	3	53	50
	5	80	75

## Auto Switch Internal Circuit

### D-F6N

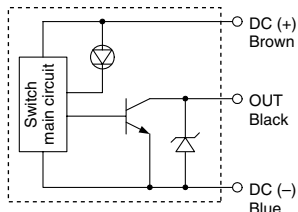

### D-F6P

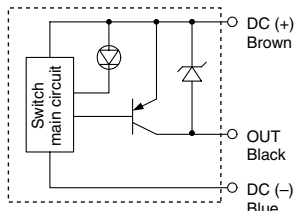

### D-F6B

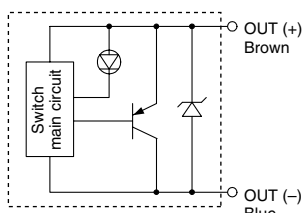

## Dimensions

Unit mm

### D-F6□

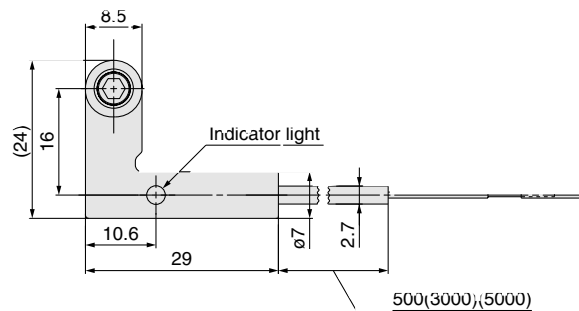

### D-F6B

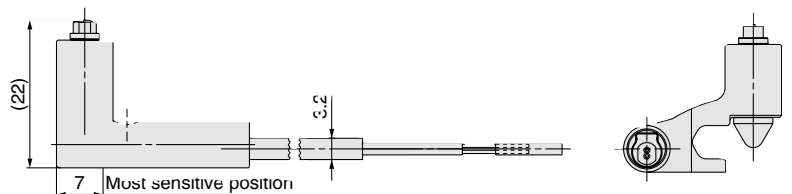

### D-F6N/F6P

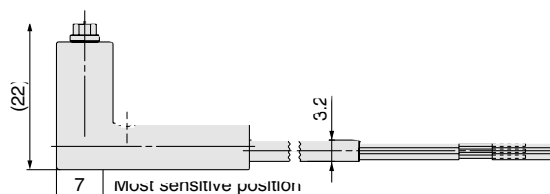





Series HY □

# Safety Instructions

These safety instructions are intended to prevent a hazardous situation and/or equipment damage. These instructions indicate the level of potential hazard by labels of "Caution", "Warning" or "Danger". To ensure safety, be sure to observe ISO 4414 <sup>Note 1)</sup>, JIS B 8370 <sup>Note 2)</sup> and other safety practices.

## ■ Explanation of the Labels

Labels	Explanation of the labels
 <b>Danger</b>	In extreme conditions, there is a possible result of serious injury or loss of life.
 <b>Warning</b>	Operator error could result in serious injury or loss of life.
 <b>Caution</b>	Operator error could result in injury <sup>Note 3)</sup> or equipment damage. <sup>Note 4)</sup>

Note 1) ISO 4414: Pneumatic fluid power – General rules relating to systems

Note 2) JIS B 8370: General Rules for Pneumatic Equipment

Note 3) Injury indicates light wounds, burns and electrical shocks that do not require hospitalization or hospital visits for long-term medical treatment.

Note 4) Equipment damage refers to extensive damage to the equipment and surrounding devices.

## ■ Selection/Handling/Applications

### 1. The compatibility of the pneumatic equipment is the responsibility of the person who designs the pneumatic system or decides its specifications.

Since the products specified here are used in various operating conditions, their compatibility for the specific pneumatic system must be based on specifications or post analysis and/or tests to meet the specific requirements. The expected performance and safety assurance are the responsibility of the person who has determined the compatibility of the system. This person should continuously review the suitability of all items specified, referring to the latest catalog information with a view to giving due consideration to any possibility of equipment failure when configuring a system.

### 2. Only trained personnel should operate pneumatically operated machinery and equipment.

Compressed air can be dangerous if handled incorrectly. Assembly, handling or repair of pneumatic systems should be performed by trained and experienced operators. (Understanding JIS B 8370 General Rules for Pneumatic Equipment, and other safety rules are included.)

### 3. Do not service machinery/equipment or attempt to remove components until safety is confirmed.

1. Inspection and maintenance of machinery/equipment should only be performed once measures to prevent falling or runaway of the driver objects have been confirmed.
2. When equipment is removed, confirm that safety process as mentioned above. Turn off the supply pressure for this equipment and exhaust all residual compressed air in the system, and release all the energy (liquid pressure, spring, condenser, gravity).
3. Before machinery/equipment is restarted, take measures to prevent quick extension of a cylinder piston rod, etc.

### 4. Contact SMC if the product will be used in any of the following conditions:

1. Conditions and environments beyond the given specifications, or if product is used outdoors.
2. Installation on equipment in conjunction with atomic energy, railway, air navigation, vehicles, medical equipment, food and beverages, recreation equipment, emergency stop circuits, clutch and brake circuits in press applications, or safety equipment.
3. An application which has the possibility of having negative effects on people, property, or animals, requiring special safety analysis.
4. If the products are used in an interlock circuit, prepare a double interlock style circuit with a mechanical protection function for the prevention of a breakdown. And, examine the devices periodically if they function normally or not.

## ■ Exemption from Liability

1. SMC, its officers and employees shall be exempted from liability for any loss or damage arising out of earthquakes or fire, action by a third person, accidents, customer error with or without intention, product misuse, and any other damages caused by abnormal operating conditions.

2. SMC, its officers and employees shall be exempted from liability for any direct or indirect loss or damage, including consequential loss or damage, loss of profits, or loss of chance, claims, demands, proceedings, costs, expenses, awards, judgments and any other liability whatsoever including legal costs and expenses, which may be suffered or incurred, whether in tort (including negligence), contract, breach of statutory duty, equity or otherwise.

3. SMC is exempted from liability for any damages caused by operations not contained in the catalogs and/or instruction manuals, and operations outside of the specification range.

4. SMC is exempted from liability for any loss or damage whatsoever caused by malfunctions of its products when combined with other devices or software.



Series **HY**□

# Auto Switch Precautions 1

Be sure to read this before handling.

## Caution on Design / Selection

### ⚠ Warning

#### 1. Confirm the specifications.

Read the specifications carefully and use this product appropriately. The product may be damaged or malfunction if it is used outside the range of specifications of current load, voltage, temperature or impact. We do not guarantee any damage in any case the product is used outside of the specification range.

#### 2. Pay attention to the length of time that a switch is on at an intermediate stroke position.

When an auto switch is placed at an intermediate position of the stroke and a load is driven at the time the piston passes, the auto switch will operate, but if the speed is too great, the operating time will be shortened and the load may not operate properly. The maximum detectable piston speed is:

$$V \text{ (mm/s)} = \frac{\text{Auto switch operating range (mm)}}{\text{Load operating time (ms)}} \times 1000$$

#### 3. Keep wiring as short as possible.

<Solid state switch>

Although wire length should not affect switch function, use a wire that is 100 m or shorter.

#### 4. Do not use a load that generates surge voltage. If a surge voltage is generated, the discharge occurs at the contact, possibly resulting in the shortening of product life.

<Solid state switch>

Although a zener diode for surge protection is connected at the output side of a solid state auto switch, damage may still occur if a surge is applied repeatedly. When directly driving a load which generates surge, such as a relay or solenoid valve, use a type of switch with a built-in surge absorbing element.

#### 5. Cautions for use in an interlock circuit

When an auto switch is used for an interlock signal requiring high reliability, devise a double interlock system to safeguard against malfunctions by providing a mechanical protection function, or by also using another switch (sensor) together with the auto switch. Also perform periodic inspection and confirm proper operation.

#### 6. Do not repair, disassemble, or make any modifications to the product, including changes in the printed circuit board, as this may result in injury or an accident.

### ⚠ Caution

#### 1. Take precautions when multiple cylinders (actuators) are used close together.

When two or more auto switch cylinders (actuators) are lined up in close proximity to each other, magnetic field interference may cause the switches to malfunction. Maintain a minimum cylinder separation of 40 mm. (When the allowable interval is specified for each cylinder series, use the indicated value.)

#### 2. Take precautions for the internal voltage drop of the switch.

- If auto switches are connected in series as shown below, take note that there will be a large voltage drop because of internal resistance in the light emitting diodes. (Refer to internal voltage drop in the auto switch specifications.)

[The voltage drop will be "n" times larger when "n" auto switches are connected.]

Even though an auto switch operates normally, the load may not operate.

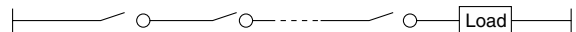

- Similarly, when operating below a specified voltage, it is possible that the load may be ineffective even though the auto switch function is normal. Therefore, the formula below should be satisfied after confirming the minimum operating voltage of the load.

$$\text{Supply voltage} - \text{Internal voltage drop of switch} > \text{Minimum operating voltage of load}$$

<Solid state switch>

Generally, the internal voltage drop will be great with a 2-wire solid state auto switch.

Also, note that a 12 VDC relay is not applicable.

#### 3. Pay attention to leakage current.

<Solid state switch>

With a 2-wire solid state auto switch, current (leakage current) flows to the load to operate the internal circuit even when in the OFF state.

$$\text{Current to operate load (OFF condition)} > \text{Leakage current}$$

If the condition given in the above formula is not met, it will not reset correctly (stays ON). Use a 3-wire switch if this specification cannot be satisfied.

Moreover, leakage current flow to the load will be "n" times larger when "n" auto switches are connected in parallel.

#### 4. Ensure sufficient clearance for maintenance activities.

When designing an application, be sure to allow sufficient clearance for maintenance and inspections.



## Series HY□

# Auto Switch Precautions 2

Be sure to read this before handling.

### Mounting and Adjustment

#### ⚠ Warning

##### 1. Instruction manual.

Install the products and operate them only after reading the instruction manual carefully and understanding its contents. Also keep the manual where it can be referred to as necessary.

##### 2. Do not drop or bump.

Do not drop, bump or apply excessive impacts (1000 m/s<sup>2</sup> or greater for solid state switches) while handling. Although the body of the switch may not be damaged, the inside of the switch could be damaged and cause a malfunction.

##### 3. Mount switches using the proper tightening torque.

When a switch is tightened above the torque specification, the mounting screws, or switch may be damaged. On the other hand, tightening below the torque specification may allow the switch to slip out of position. (Refer to switch mounting for each series regarding switch mounting, moving, and fastening torque, etc.)

##### 4. Mount a switch at the center of the operating range.

Adjust the mounting position of an auto switch so that the piston stops at the center of the operating range (the range in which a switch is ON). (The mounting positions shown in the catalog indicate the optimum position at the stroke end.) If mounted at the end of the operating range (around the borderline of ON and OFF), operation will be unstable.

##### 5. Secure the space for maintenance.

When installing the products, please allow access for maintenance.

#### ⚠ Caution

##### 1. Do not carry an actuator by the auto switch lead wires.

Never carry a cylinder by its lead wires. This may not only cause broken lead wires, but it may cause internal elements of the switch to be damaged by the stress.

##### 2. Fix the switch with the appropriate screw installed on the switch body. If using other screws, switch may be damaged.

### Wiring

#### ⚠ Warning

##### 1. Confirm proper insulation of wiring.

Be certain that there is no faulty wiring insulation (such as contact with other circuits, ground fault, improper insulation between terminals, etc.). Damage may occur due to excess current flow into a switch.

##### 2. Do not wire in conjunction with power lines or high voltage lines.

Wire separately from power lines or high voltage lines, avoiding parallel wiring or wiring in the same conduit with these lines. Control circuits containing auto switches may malfunction due to noise from these lines.

### Wiring

#### ⚠ Caution

##### 1. Avoid repeatedly bending or stretching lead wires.

Broken lead wires will result from repeatedly applying bending stress or stretching force to the lead wires.

##### 2. Be sure to connect the load before power is applied.

###### <2-wire type>

If the power is turned ON when an auto switch is not connected to a load, the switch will be instantly damaged because of excess current.

##### 3. Do not allow short circuit of loads.

###### <Solid state switch>

F6□ does not have built-in short circuit protection circuits. If loads are short circuited, the switches will be instantly damaged, as in the case of reed switches.

Take special care to avoid reverse wiring with the brown power supply line and the black output line on 3-wire type switches.

##### 4. Avoid incorrect wiring.

###### <Solid state switch>

If connections are reversed on a 2-wire type switch, the switch will not be damaged if protected by a protection circuit, but the switch will always stay in an ON state. However, it is still necessary to avoid reversed connections, since the switch could be damaged by a load short circuit in this condition.

###### <F6□>

D-F6□ does not have built-in short circuit protection circuit. Be aware that if the power supply connection is reversed (e.g. (+) power supply wire and (-) power supply wire connection is reversed), the switch will be damaged.

##### 5. When the cable sheath is stripped, confirm the stripping direction. The insulator may be split or damaged depending on the direction. (D-F6□)

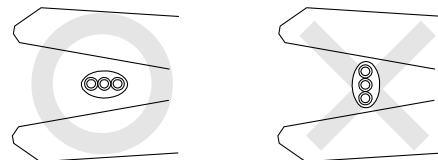

#### Recommended Tool

Model name	Model no.
Wire stripper	D-M9N-SWY

\* Stripper for a round cable (ø2.0) can be used for a 2-wire type cable.



Series **HY** □

# Auto Switch Precautions 3

Be sure to read this before handling.

## Operating Environment

### ⚠ Warning

- 1. Never use in an atmosphere of explosive gases.**  
The construction of the auto switch is not intended to prevent explosion. Never use in an atmosphere with an explosive gas since this may cause a serious explosion.
- 2. Do not use in an area where a magnetic field is generated.**  
The auto switch will malfunction or the magnets inside of an actuator will become demagnetized if used in such an environment.
- 3. Do not use in an environment where the auto switch will be continually exposed to water.**  
The switch satisfies the IEC standard IP67 construction (JIS C 0920: waterproof construction). Nevertheless, it should not be used in applications where it is continually exposed to water splash or spray. This may cause deterioration of the insulation or swelling of the potting resin inside switch causing a malfunction.
- 4. Do not use in an environment with oil or chemicals.**  
Consult with SMC if the auto switch will be used in an environment with coolant, cleaning solvent, various oils or chemicals. If the auto switch is used under these conditions for even a short time, it may be adversely effected by a deterioration of the insulation, a malfunction due to swelling of the potting resin, or hardening of the lead wires.
- 5. Do not use in an environment with temperature cycles.**  
Consult with SMC if the switch is used where there are temperature cycles other than normal temperature changes, as they may adversely affected the switch internally.
- 6. Do not use in an area where surges are generated.**  
<Solid state switch>  
When there are units (such as solenoid type lifters, high frequency induction furnaces, motors, etc.) that generate a large amount of surge in the area around an actuator with a solid state auto switch, their proximity or pressure may cause deterioration or damage to the internal circuit of the switch. Avoid sources of surge generation and crossed lines.

### ⚠ Caution

- 1. Avoid accumulation of iron debris or close contact with magnetic substances.**  
When a large accumulated amount of ferrous waste such as machining chips or welding spatter, or a magnetic substance (something attracted by a magnet) is brought into close proximity to a cylinder with auto switches, this may cause the auto switches to malfunction due to a loss of the magnetic force inside the cylinder.
- 2. Contact SMC for the water resistance ability, the elasticity ability of the lead wire, and the welding site etc.**
- 3. Do not expose the product to direct sunlight for an extended period of time.**
- 4. Do not use the product in locations where it is exposed to radiant heat.**

## Maintenance

### ⚠ Warning

- 1. Perform the following maintenance periodically in order to prevent possible danger due to unexpected auto switch malfunction.**
  - 1) Securely tighten switch mounting screws.  
If screws become loose or the mounting position is dislocated, retighten them after readjusting the mounting position.
  - 2) Confirm that there is no damage to the lead wires.  
To prevent faulty insulation, replace switches or repair lead wires, etc., if damage is discovered.
- 2. Perform the maintenance procedures outlined in the instruction manual.**  
If the maintenance procedures are performed improperly, malfunction or damage to the machinery or equipment may occur.
- 3. Removal of equipment, and supply/exhaust of compressed air.**  
When an equipment is serviced, first confirm that measures are in place to prevent workpieces from dropping run-away equipment, etc. Then cut the supply pressure and power, and exhaust all compressed air from the system using the residual pressure release function.  
When the equipment is operated after remounting or replacement, first confirm that measures are in place to prevent lurching of actuators, etc. Then confirm that the equipment is operating normally.



# Series HY□

## Specific Product Precautions 1

Be sure to read this before handling.

Please refer to the back of page 1 to 4 for Safety Instruction and Auto Switch Precautions.

### Caution on Design

#### ⚠ Caution

1. Speed adjustment should be conducted in the environment where the cylinder is used.

In a different environment, the speed adjustment may be incorrect.

2. There are possibilities that dust may accumulate by the usage condition in the thread part and brackets for mounting of this products.

Do measures according to the usage condition when you mount it.

### Operating Environment

#### ⚠ Caution

1. Avoid installing and using a cylinder inside a food zone.

<Not installable>

Food zone ..... An environment where food which will be sold as merchandize, directly touches the cylinder's components.

<Installable>

Splash zone ..... An environment where food which will not be sold as merchandize, directly touches the cylinder's components.

Non-food zone ..... An environment where there is no contact with food.

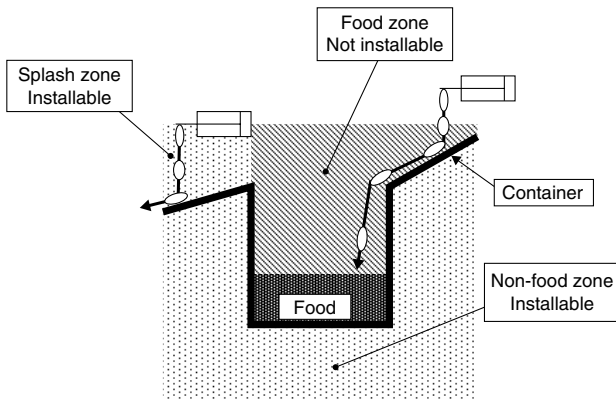

2. When a detergent or chemical liquid other than water is splashed on the cylinder, the cylinder's service life may be substantially shortened. Please contact us for details.

3. When washing a cylinder with steam, please observe the allowable temperature range of the cylinder and perform for a short period of time.

4. When washing a cylinder with a brush, etc., please do not apply excessive force to the auto switch's lead wire, etc.

### Mounting

#### ⚠ Warning

1. Do not put hands or fingers, etc. between the plate and body. [Series HYG]

Care should be taken that hands or fingers do not get caught in between the cylinder body and the plate when air pressure is applied.

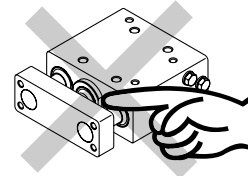

#### ⚠ Caution

1. Design the aptitude enough by thinking about the rigidity of mount because the cylinder puts out big power.
2. Tighten in following tightening torque when you install the auto switch rail when repairing it.

Thread size	Tightening torque (N·m)
M4	1.1 to 1.9

3. Do not apply any force to lead wires when auto switch is mounted on cylinder.

Never apply any force to lead wires. This may not only cause broken lead wires, but it may cause internal elements of the switch to be damaged by the stress. Moreover, the switch might not operate when force applies to the lead wire and the distance between the switch and the cylinder become long.

4. Pay attention to magnetic substance density between the auto switch and the cylinder body and the circumference.

When a magnetic substance is brought into close proximity with an auto switch and cylinder, it may cause the auto switch to malfunction due to a loss of the magnetic force inside the cylinder.

5. When the cylinder, the support bracket and the plug bolt are mounted, tighten them within below tightening torque. [Series HYB]

Bore size	Thread size	Tightening torque (N·m)
ø20	M4 x 0.7	1.1 to 1.9
ø25, ø32	M5 x 0.8	2.1 to 3.9
ø40	M6 x 1	3.7 to 6.7
ø50	M8 x 1.25	8.8 to 16.2
ø63, ø80	M10 x 1.5	17.2 to 31.8
ø100	M12 x 1.75	29.4 to 54.6

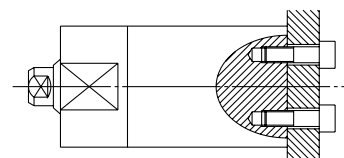



# Series HY □

## Specific Product Precautions 2

Be sure to read this before handling.

Please refer to the back of page 1 to 4 for Safety Instruction and Auto Switch Precautions.

### Mounting

#### ⚠ Caution

[Series HYC]

Bore size	Thread size	Tightening torque (N·m)
ø32, 40	M6 x 1	3.7 to 6.7
ø50, 63	M8 x 1.25	8.8 to 16.2

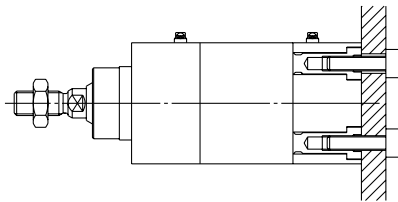

6. When the cylinder, the support bracket and the external cover are mounted, tighten them within below tightening torque. [Series HYQ]

Bore size	Thread size	Tightening torque (N·m)
ø20	M5 x 0.8	2.1 to 3.9
ø25, 32, 40	M6 x 1	3.7 to 6.7
ø50, 63	M8 x 1.25	8.8 to 16.2

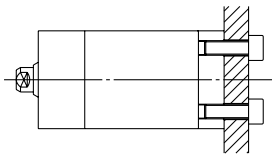

7. When the cylinder, the plug bolt and the load are mounted, tighten within below tightening torque. [Series HYG]

Top Mounting

Bore size	Thread size	Tightening torque (N·m)
ø20, 25	M5 x 0.8	2.1 to 3.9
ø32, 40	M6 x 1	3.7 to 6.7
ø50, 63	M8 x 1.25	8.8 to 16.2

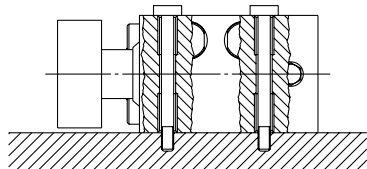

Lower Side Mounting

Bore size	Thread size	Tightening torque (N·m)
ø20, 25	M6 x 1	3.7 to 6.7
ø32, 40	M8 x 1.25	8.8 to 16.2
ø50, 63	M10 x 1.5	17.2 to 31.8

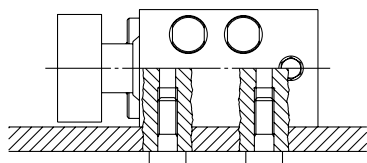

#### ⚠ Caution

Bottom Mounting or Load Mounting

Bore size	Thread size	Tightening torque (N·m)
ø20	M5 x 0.8	2.1 to 3.9
ø25	M6 x 1	3.7 to 6.7
ø32, 40	M8 x 1.25	8.8 to 16.2
ø50, 63	M10 x 1.5	17.2 to 31.8

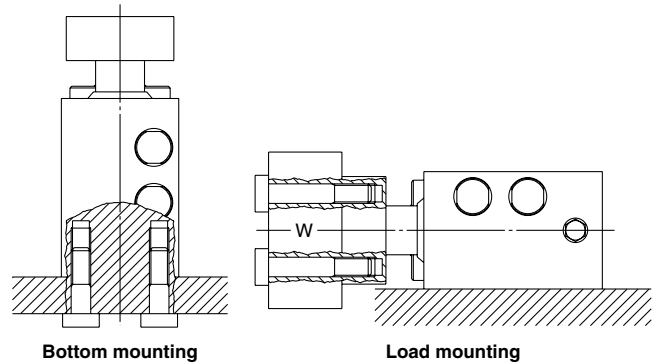

Plug Bolt Mounting (Optional)

Thread size	Tightening torque (N·m)
M5 x 0.8	2.1 to 3.9
M6 x 1	3.7 to 6.7
M8 x 1.25	8.8 to 16.2
M10 x 1.5	17.2 to 31.8

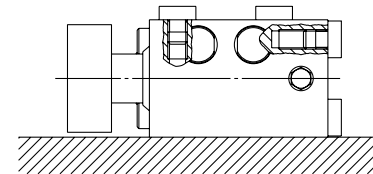

8. Install the load when the piston rod is retracted. [Series HYG]

The twist occurs in the guide part if the load is installed on the plate when the piston rod is extended, and it causes the malfunction.

### Lubrication

#### ⚠ Caution

1. Lubrication of Hygienic Design Cylinder (standard grease use goods).

This unit can be operated without lubrication. If lubrication is performed, build in the lubricator in the circuit, use turbine oil Class 1 (with no additives) ISO VG32.

Moreover, the malfunction will occur if the lubrication is discontinued on the way because the disappearance of the initial lubrication part. Lubricate without fail continuously. Consult with SMC if other lubricant are used.





# Series HY □

## Specific Product Precautions 3

Be sure to read this before handling.

Please refer to the back of page 1 to 4 for Safety Instruction and Auto Switch Precautions.

### Lubrication

#### ⚠ Caution

##### 2. Lubrication to Hygienic Design Cylinder (food compatible grease use goods).

If this unit is lubricated, it might cause the malfunction. Moreover, when a grease out of specification is used, it causes the malfunction.

- Place a purchase order with the following model number when only the grease for maintenance is necessary.
 

Standard grease (for non-food)	GR-S-010 (10 g)
Food compatible grease	GR-H-010 (10 g)

##### 3. Do not wipe off the grease adhering to the sliding part of the air cylinder.

It might cause the malfunction when compulsorily peeling off the adhering grease to the sliding parts. If the cylinder operates the long distance, the sliding parts might become black. In that case, the actuation becomes possible for a long term when the grease of the sliding parts is wiped off once, and it greases it again.

(Wipe off by water. If alcohol and a special solvent are used, the seal might be damaged.)

### Cushion (HYC)

#### ⚠ Caution

##### 1. Readjust with the cushion needle.

Readjust the cushion needle installed in the cover according to the load size and the operating speed before use, though it is adjusted to near the fully closed states when it ships. When the cushion adjuster is rotated to clockwise, the throttle strengthens becomes tight and the cushion strengthens will be good.

##### 2. Do not use the cushion needle for a long term in the fully closed states.

It causes the damage of the seal.

##### 3. Torque to the cushion adjuster should be below of the following torque when the cushion needle is adjusted.

Tightening torque (N·m)
0.5

Do not exceed the torque mentioned above. Otherwise it causes the damage.

##### 4. Do not exceed the adjustable range of cushion needle.

If cushion needle is rotated with the torque over adjustable range, it causes the damage.

Bore size	Rotations
ø32, 40	4 or less
ø50, 63	5 or less

### Piping

#### ⚠ Caution

##### 1. This product might be damaged if the compressed air is supplied to the breathing port for guide, so do not supply it. [Series HYG]

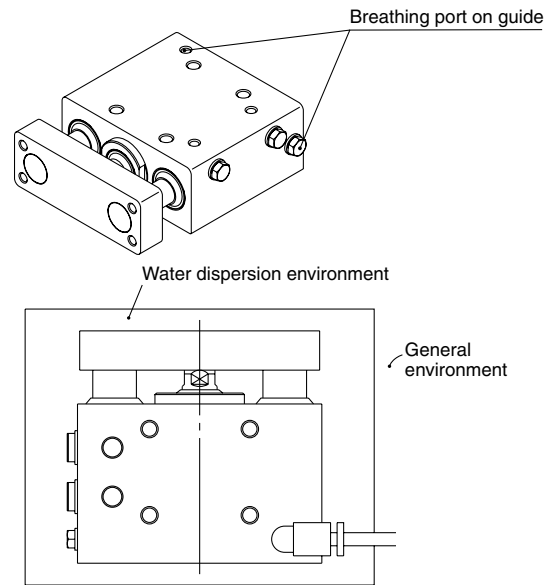

<Example>

- Piping is connected in the breathing port on guide, breathing at general environment is possible.

##### 2. Plug piping ports and breathing port on guide according to the operating conditions. [Series HYG]

###### Piping Port

Bore size	Plug thread size	Plug width across flats	Tightening torque (N·m)
ø20, 25	M5	8	After tightening by hand, tighten 1/6 turn.
ø32, 40	1/8	13	7 to 9
ø50, 63	1/4	16	12 to 14

###### Breathing Port for Guide

Bore size	Plug thread size	Plug width across flats	Tightening torque (N·m)
ø20 to ø63	M5	8	After tightening by hand, tighten 1/6 turn.

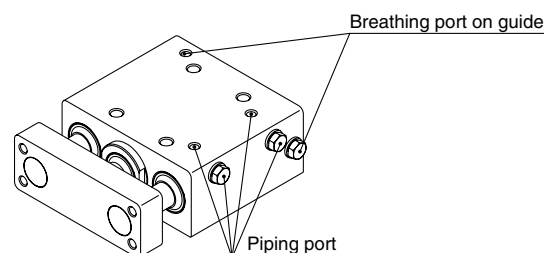

##### 3. Use the piping tube installed in the breathing port for guide is more than ø4 in bore size and within 3 m in length, otherwise the cylinder piston speed might decrease.



Series **HY** □

## Specific Product Precautions 4

Be sure to read this before handling.

Please refer to the back of page 1 to 4 for Safety Instruction and Auto Switch Precautions.

### Caution on Handling

#### **Caution**

- 1 If the sliding parts is washed, the grease will wash out and the service life will be shorten, keep washing at a minimum.
2. Plug up unnecessary mounting holes with plug bolts or external cover (optional), etc., bacteria might grow if water gets in these holes.



#### **Safety Instructions**

Be sure to read "Precautions for Handling Pneumatic Devices" (M-03-E3A) before using.

## SMC Corporation

1-16-4 Shimbashi, Minato-ku, Tokyo 105-8659 JAPAN

Tel: 03-3502-2740 Fax: 03-3508-2480

URL <http://www.smcworld.com>

© 2005 SMC Corporation All Rights Reserved

Specifications are subject to change without prior notice  
and any obligation on the part of the manufacturer

D-DN

1st printing JT printing JY 120DN Printed in Japan.

This catalog is printed on recycled paper with concern for the global environment.