

# Peltier-Type Temperature Control System for Chemical Liquids Chemical Thermo-con

## HED Series

**Fluororesin** heat exchanger allows **direct temperature control for chemical liquids!!**



SEMI Standard  
S2-0706, F47-0706

RoHS

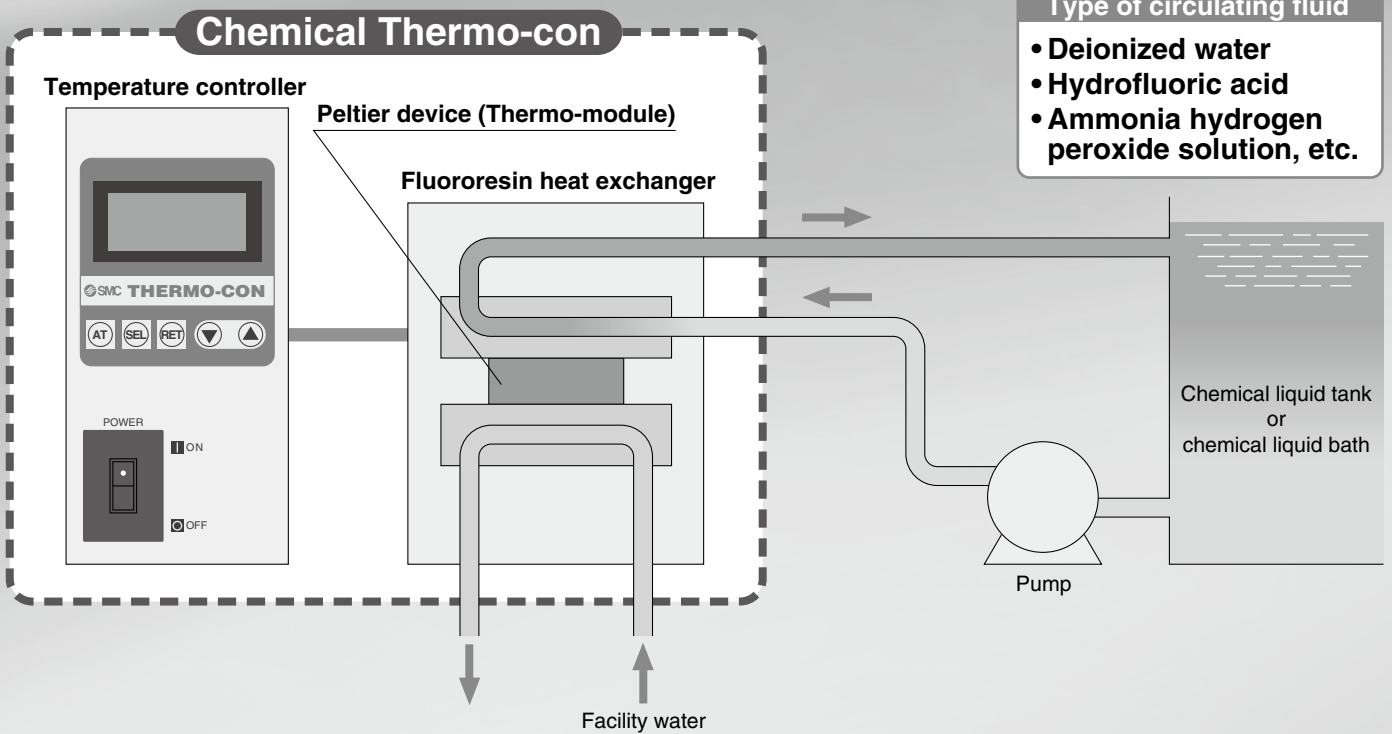

Industry-leading withstand pressure **0.35 MPa!!**

- With leakage detection function
- Operating temperature range:  
**10°C to 60°C**
- Temperature stability: **±0.1°C**
- Cooling capacity (with water):  
**300 w, 500 w, 750 w**



# Allows direct control of chemical liquid temperature.

- PFA wetted parts material prevents contamination from metal ion elution.
- No need for a tube-type heat exchanger.

## Indirect temperature control

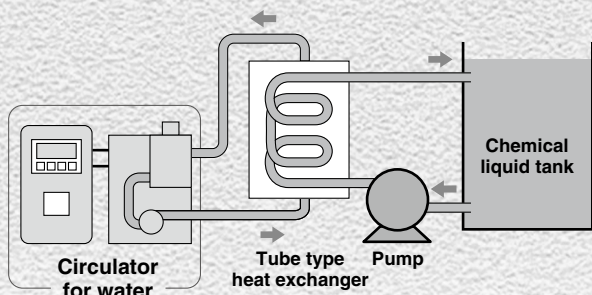

## Direct temperature control

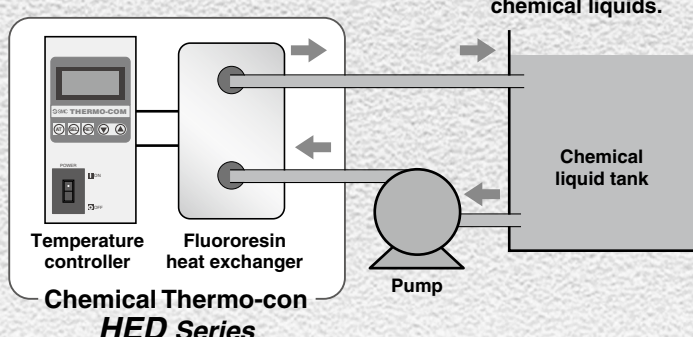

# Compact and light

- Self-developed heat exchanger matched to the configuration of the Peltier device (Thermo-module). Compact and light

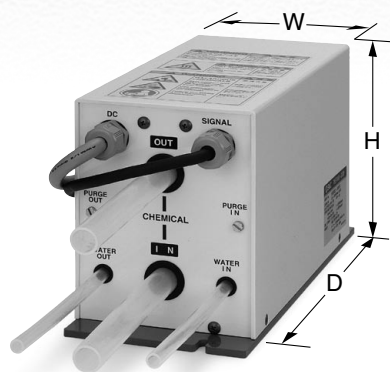

## Heat Exchanger

Model	W	D	H	Weight
HED003	130	263	170	8 kg
HED005	150	294	222	14 kg
HED007				15 kg

The outline dimensions do not include protruding parts such as the foot flange and tube.

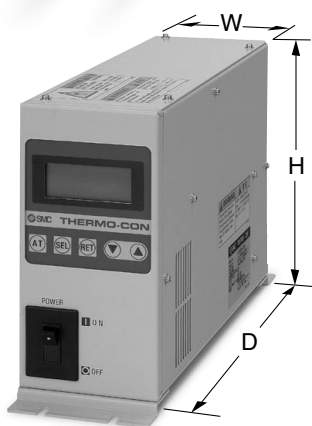
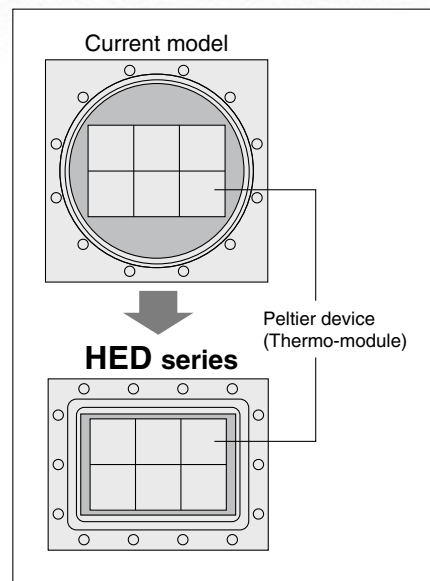

## Temperature Controller

Model	W	D	H	Weight
HED003	100	320	215	6 kg
HED005	140	350	215	8 kg
HED007	165	447	215	13 kg

The outline dimensions do not include protruding parts such as the foot flange, screw and connector.

## ● Applications

Cleaning equipment

Plating equipment

Wet etching equipment, etc.

## ● Applicable Fluid Examples

Chemical liquids	Operating temperature range	Chemical liquids	Operating temperature range
Deionized water	10 to 60°C	Ammonia hydrogen peroxide solution	10 to 60°C
Hydrofluoric acid	10 to 40°C	Sodium hydroxide	10 to 60°C
Sulfuric acid (except fuming sulfuric acid)	10 to 50°C	Ozone water	10 to 60°C
Copper sulfate solution	10 to 50°C		

\* No condensation

\* Chemical Thermo-con is not designed to be explosion proof, so it is not suitable for flammable fluids.

# Principle of Peltier Device (Thermo-module, Thermoelectric device)

The Peltier device (thermo-module, thermoelectric device) is plate-shape solid state element with P-type, N-type semiconductor arrayed alternately. When direct current is supplied to the element, heat moves from one surface to another along with electron flow in N-type semiconductor and electron hole in P-type semiconductor. As a result of the heat move, one surface of the element absorbs heat and decrease temperature. And other surface heats up. When the DC current is switched to reverse direction, the heat move will also be reverse direction. Therefore, Peltier element can achieve heating effect as well as cooling effect depending on the current direction. It can achieve high speed switching and precise temperature control.

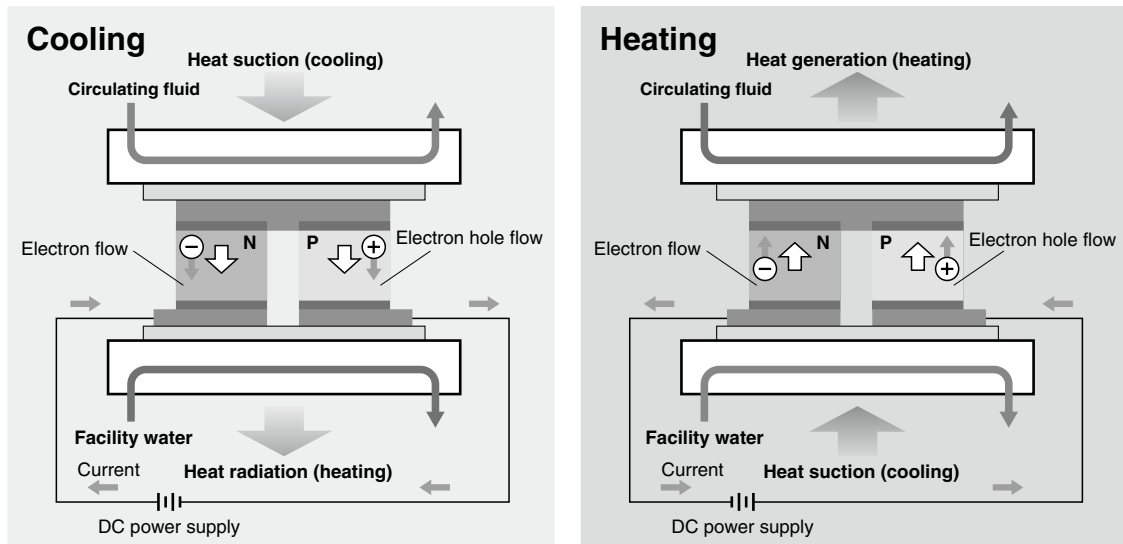

## Construction and Principle

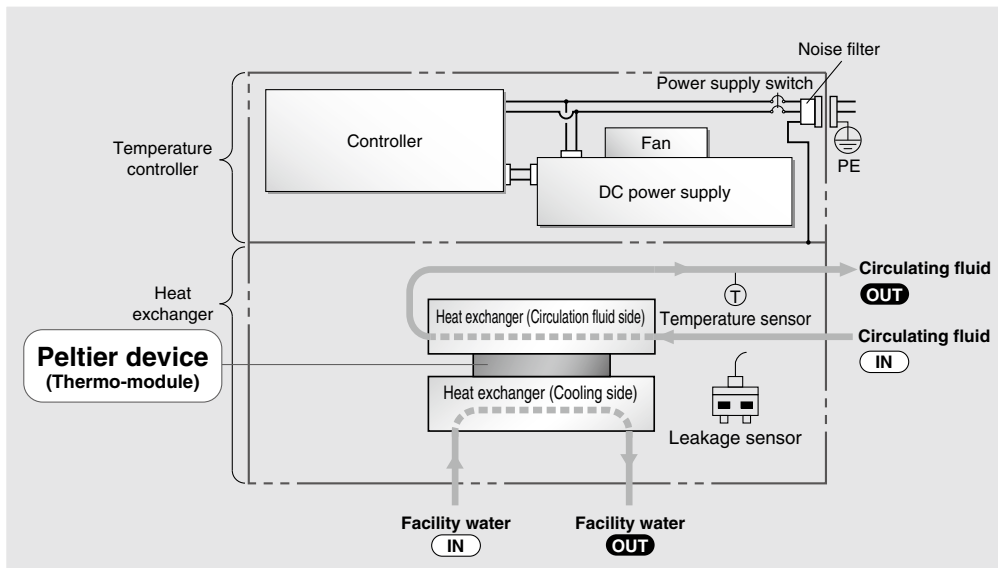

The temperature controller controls the circulating fluid in the heat exchanger. A temperature sensor (platinum resistance temperature detector) installed in the heat exchanger sends a signal to the controller, which changes the temperature of the circulating fluid by adjusting the output direction and energizing time of the built-in DC power supply based on the difference between the set and measured temperatures. This product can be used safely since the sensor to detect leakage of the circulating fluid is installed as a standard device.

# CONTENTS

## *HED Series*



### Chemical Thermo-con HED Series

Model Selection .....	Page 360
How to Order .....	Page 361
Main Specifications .....	Page 362
· Heat Exchanger Specifications .....	Page 362
· Temperature Controller Specifications .....	Page 362
Cooling Capacity .....	Page 363
Heating Capacity .....	Page 363
Pressure Loss in Circulating Fluid Circuit .....	Page 364
Pressure Loss in Facility Water Circuit .....	Page 364
Dimensions .....	Page 365
Connectors .....	Page 367
Alarm .....	Page 368
Maintenance .....	Page 368

● <b>Applicable Fluids</b> .....	Page 369
Specific Product Precautions .....	Page 370

# HED Series Model Selection

## Guide to Model Selection

### Example 1: When the heat generation amount in the user's equipment is known.

Heat generation amount  $Q$ : 400 W (at 25°C)

Cooling capacity = Considering a safety factor of 20%, select  $400 \text{ W} \times 1.2 = \boxed{480 \text{ W (at 25°C)}}$  or more.

### Example 2: When the heat generation amount in the user's equipment is not known.

Obtain the temperature difference between inlet and outlet by circulating the circulating fluid inside the user's equipment.

Heat generation amount $Q$	: Unknown
Circulating fluid temperature difference $\Delta T (= T_2 - T_1)$	: 1.0°C (1.0 K)
Circulating fluid outlet temperature $T_1$	: 20°C (293.15 K)
Circulating fluid inlet temperature $T_2$	: 21°C (294.15 K)
Circulating fluid flow rate $L$	: 7 L/min
Circulating fluid	: Water
	: Density $\gamma$ : $1 \times 10^3 \text{ kg/m}^3$
	: Specific heat $C$ : $4.2 \times 10^3 \text{ J/(kg}\cdot\text{K)}$

$$Q = \frac{\Delta T \times L \times \gamma \times C}{60 \times 1000}$$

$$= \frac{1 \times 7 \times 1 \times 10^3 \times 4.2 \times 10^3}{60 \times 1000}$$

$$= 490 \text{ W}$$

Cooling capacity = Considering a safety factor of 20%,  
 $490 \times 1.2 = \boxed{588 \text{ W}}$

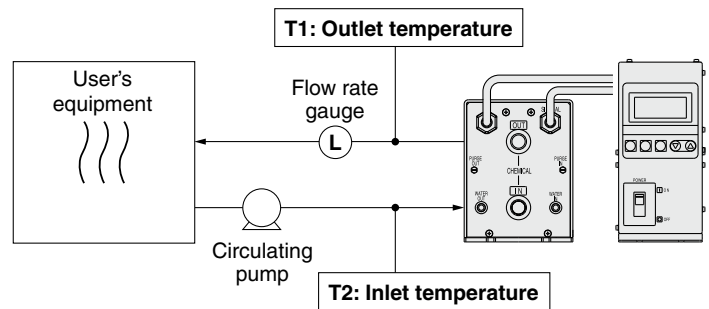

### Example 3. In cases where cooling the object below a certain temperature and period of time.

Cooled substance total volume $V$	: 20 L
Cooling time $h$	: 15 min
Cooling temperature difference $\Delta T$	: 5°C (5 K)
Circulating fluid	: Tap water
	Density $\gamma$ : $1 \times 10^3 \text{ kg/m}^3$
	Specific heat $C$ : $4.2 \times 10^3 \text{ J/(kg}\cdot\text{K)}$

$$Q = \frac{\Delta T \times V \times \gamma \times C}{h \times 60 \times 1000}$$

$$= \frac{5 \times 20 \times 1 \times 10^3 \times 4.2 \times 10^3}{15 \times 60 \times 1000}$$

$$= 467 \text{ W}$$

Cooling capacity = Considering a safety factor of 20%,  
 $467 \times 1.2 = \boxed{560 \text{ W}}$

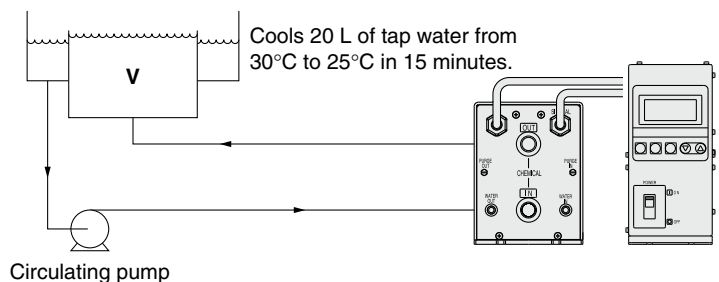

## Precautions on Model Selection

The flow rate of the circulating fluid depends on the internal resistance of the user's equipment and the length, diameter and resistance created by bends in the circulating fluid piping, etc. Check if the required flow rate of circulating fluid can be obtained before using.

# Chemical Thermo-con

## HED Series



### How to Order

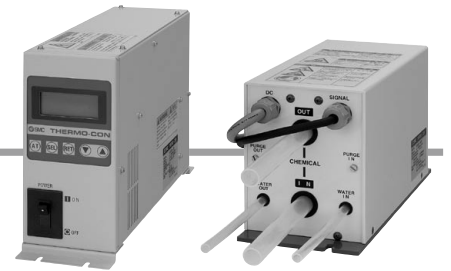

Temperature controller

Heat exchanger

### Part Number of Set (Temperature Controller + Heat Exchanger)

\* The model numbers of the temperature controller and heat exchanger are printed respectively on the product name label.

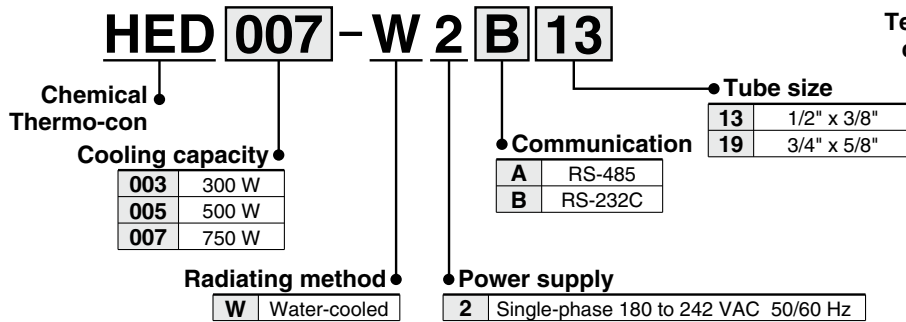

### Combination in Set

Part number of set	Heat exchanger model	Temperature controller model
HED003-W2A13	HED003-HW13	HED003-C2A
HED003-W2A19	HED003-HW19	
HED003-W2B13	HED003-HW13	HED003-C2B
HED003-W2B19	HED003-HW19	
HED005-W2A13	HED005-HW13	HED005-C2A
HED005-W2A19	HED005-HW19	
HED005-W2B13	HED005-HW13	HED005-C2B
HED005-W2B19	HED005-HW19	
HED007-W2A13	HED007-HW13	HED007-C2A
HED007-W2A19	HED007-HW19	
HED007-W2B13	HED007-HW13	HED007-C2B
HED007-W2B19	HED007-HW19	

### Heat Exchanger

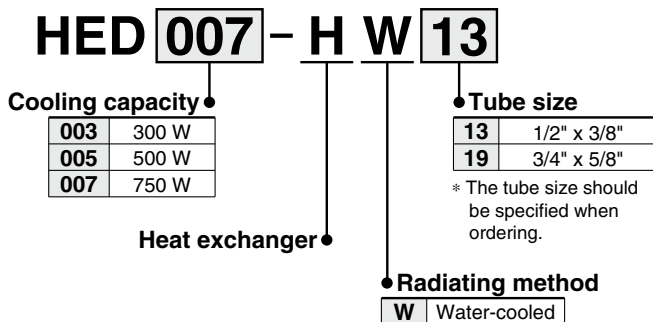

### Temperature Controller

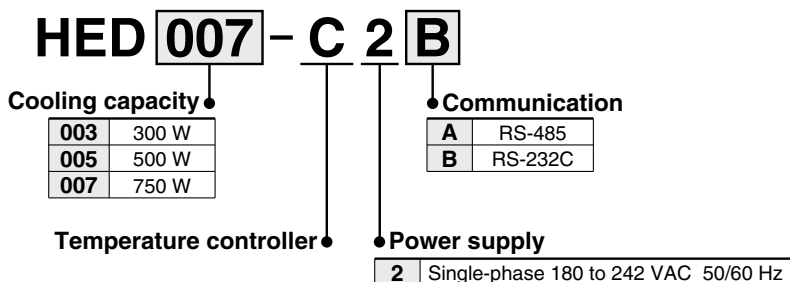

**Main Specifications** (For details, please refer to our "Product Specifications" information.)

**Heat Exchanger Specifications**

Heat exchanger model		HED003-HW13	HED003-HW19	HED005-HW13	HED005-HW19	HED007-HW13	HED007-HW19
<b>Cooling capacity (Water)*1</b>		300 W		500 W		750 W	
<b>Heating capacity (Water)*1</b>		600 W		1000 W		1800 W	
<b>Cooling/Heating method</b>		Peltier device (Thermoelectric device, Thermo-module)					
<b>Radiating method</b>		Water-cooled					
<b>Operating temperature range</b>		10.0 to 60.0°C (depending on the type of circulating fluid)					
<b>Circulating fluid</b>	<b>Applicable fluid*2</b>	Deionized water, Hydrofluoric acid, Ammonia hydrogen peroxide solution, etc.					
	<b>Fluid contact material</b>	PFA					
	<b>Operating pressure*3</b>	0 (atmospheric pressure) to 0.35 MPa					
	<b>Tube size (PFA tube)</b>	1/2" x 3/8"	3/4" x 5/8"	1/2" x 3/8"	3/4" x 5/8"	1/2" x 3/8"	3/4" x 5/8"
<b>Facility water</b>	<b>Temperature</b>	10 to 35°C (no condensation)					
	<b>Fluid contact material</b>	FEP, Stainless steel 304, Stainless steel 316					
	<b>Max. operating pressure</b>	0.5 MPa					
	<b>Tube size</b>	IN/OUT: FEP tube 3/8" x 1/4"					
<b>Flow rate</b>	5 to 10 L/min						
<b>Ambient temperature/humidity</b>		Temperature: 10 to 35°C, Humidity: 35 to 80%RH (no condensation)					
<b>Dimensions*4</b>		W130 mm x D263 mm x H170 mm		W150 mm x D294 mm x H222 mm		W150 mm x D294 mm x H222 mm	
<b>Weight</b>		Approx. 8 kg		Approx. 14 kg		Approx. 15 kg	
<b>Applied temperature controller</b>		HED003-C2A HED003-C2B		HED005-C2A HED005-C2B		HED007-C2A HED007-C2B	

\*1 The conditions are as follows.

Circulating fluid: Water (Circulating flow rate 15 L/min, Set temperature 25°C), Facility water temperature 25°C, Facility water flow rate 5 L/min, Ambient temperature 25°C

\*2 For the compatibility between the circulating fluid and materials, refer to "Applicable Fluids".

Note that the Chemical Thermo-con is not designed to be explosion proof so it is not suitable for flammable fluids.

\*3 Install the heat exchanger in the discharge side of a circulating pump. Do not use at location where a negative pressure is applied. The circulating fluid pump should be prepared by user.

\*4 The outline dimensions do not include protruding parts such as the foot flange and tube.

**Temperature Controller Specifications**

Temperature controller model		HED003-C2A	HED003-C2B	HED005-C2A	HED005-C2B	HED007-C2A	HED007-C2B
<b>Communication</b>		RS-485	RS-232C	RS-485	RS-232C	RS-485	RS-232C
<b>Control method</b>		Cooling/Heating automatic shift PID control					
<b>Operating temperature range</b>		10.0 to 60.0°C (no condensation)					
<b>Temperature stability*1</b>		Within ±0.1°C (with stable load)					
<b>Temperature sensor</b>		Resistance thermometer Pt100 Ω, 3-wires, class A, 2 mA (for both internal control sensor and external sensor) The external sensor should be prepared by user.					
<b>Main functions</b>		Auto-tuning, Sensor fine adjustment, Offset, Learning control, External sensor control, Set value memory, Upper/Lower temperature limit alarm, Output shutdown alarm, Remote ON/OFF, Leakage detection					
<b>Ambient temperature/humidity</b>		Temperature: 10 to 35°C, Humidity: 35 to 80%RH (no condensation)					
<b>Power supply spec.</b>	<b>Power supply</b>	Single-phase 180 to 242 VAC 50/60 Hz					
	<b>Rated current</b>	3 A		5 A		14 A	
<b>Dimensions*2</b>		W100 mm x D320 mm x H215 mm		W140 mm x D350 mm x H215 mm		W165 mm x D447 mm x H215 mm	
<b>Weight</b>		Approx. 6 kg		Approx. 8 kg		Approx. 13 kg	
<b>Applied heat exchanger*3</b>		HED003-HW13 HED003-HW19		HED005-HW13 HED005-HW19		HED007-HW13 HED007-HW19	

\*1 This value is with a stable load with no disturbance and cannot be achieved in some operating conditions.

\*2 The outline dimensions do not include protruding parts such as the foot flange, screw and connector.

\*3 The temperature controller should be connected with a specific series of heat exchanger. If connected with a different series of heat exchanger, it may not operate normally. (The HED003 and HED005 series use the same connector, so be careful for incorrect wiring.)

**⚠ Caution**

• For the combination of the heat exchanger and temperature controller, refer to "Combination in Set."

HRS  
HRS090  
HRS100/150  
HRS090  
HRS  
HRS  
HRS  
HRZ  
HRZD  
HRW  
HECR  
HEC  
HEB  
HED  
Technical Data

# HED Series

The values shown on the performance chart are representative and not guaranteed. Allow a margin for safety to device when choosing the product.

## Cooling Capacity <Conditions> Circulating fluid: Tap water, Circulating fluid flow rate: 15 L/min, Facility water flow rate: 5 L/min

### HED003

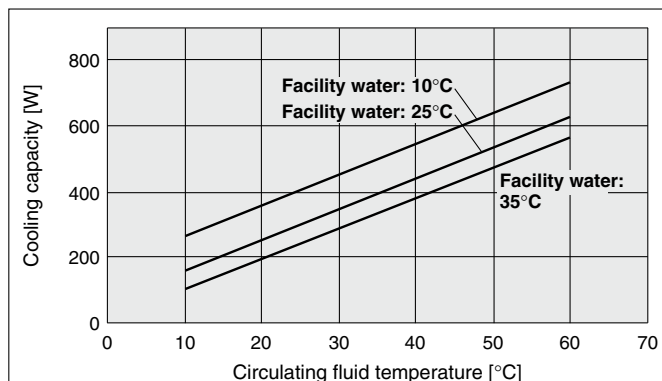

### HED005

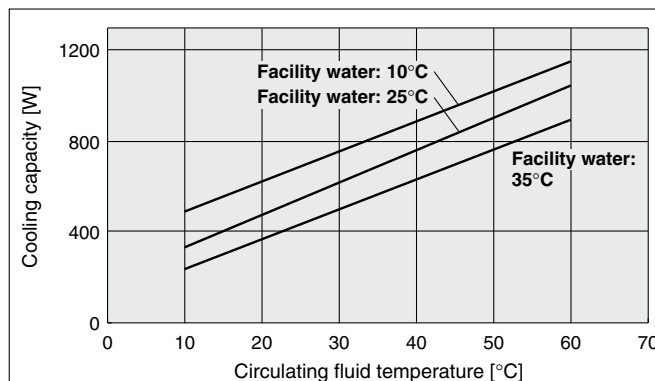

### HED007

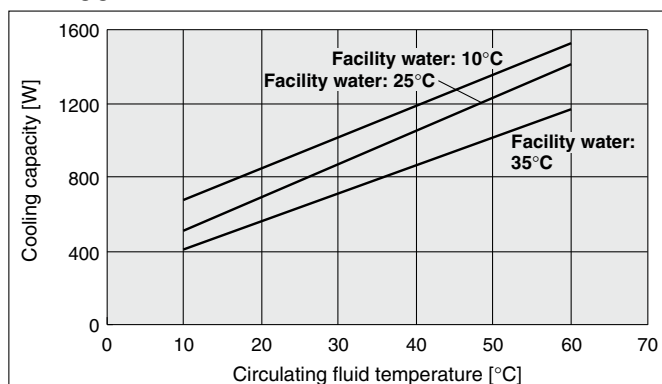

## Heating Capacity <Conditions> Circulating fluid: Tap water, Circulating fluid flow rate: 15 L/min, Facility water flow rate: 5 L/min

### HED003

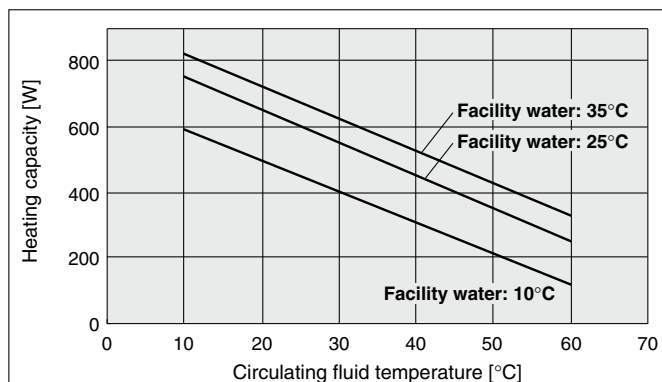

### HED005

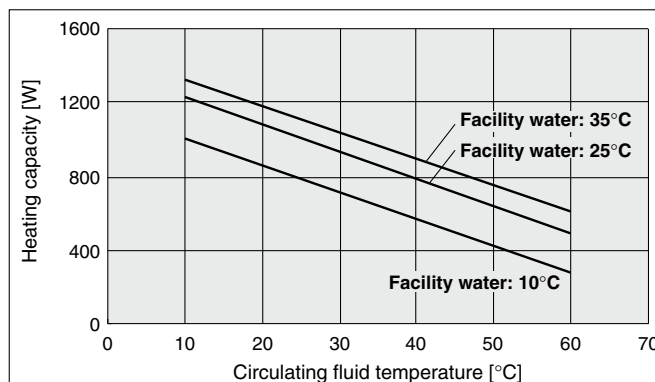

### HED007

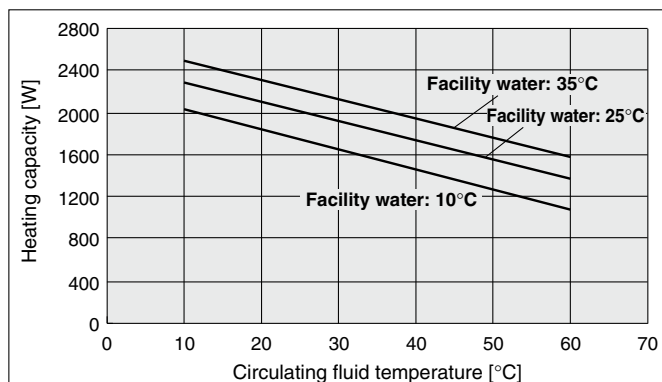



**Pressure Loss in Circulating Fluid Circuit** <Condition> Tap water

**HED003**

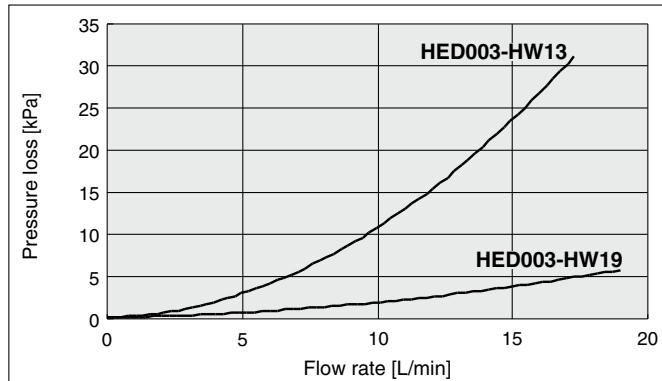

**HED005  
HED007**

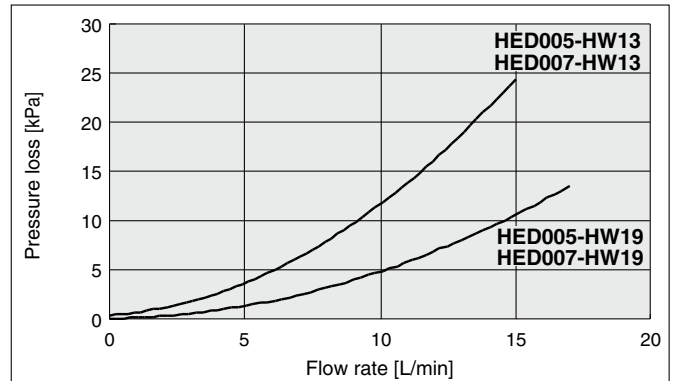

**Pressure Loss in Facility Water Circuit** <Condition> Tap water

**HED003**

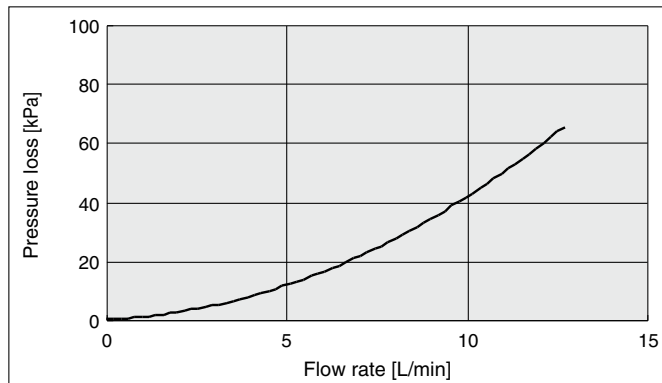

**HED005  
HED007**

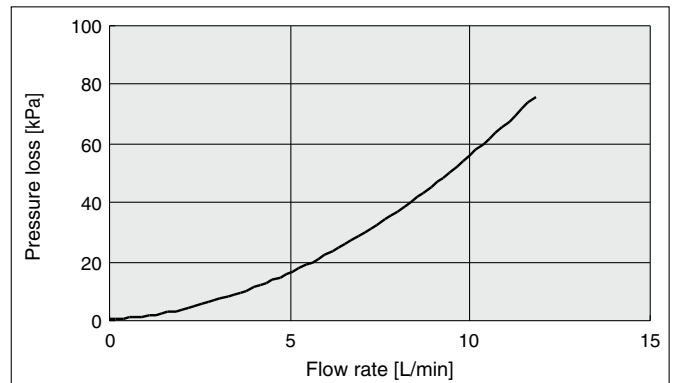

- HRS
- HRS090
- HRS100/150
- HRSH090
- HRSH
- HRSE
- HRZ
- HRZD
- HRW
- HECR
- HEC
- HEB
- HED
- Technical Data

# HED Series

## Dimensions

### HED003-W2□□

Temperature controller Heat exchanger  
HED003-C2□ HED003-HW□

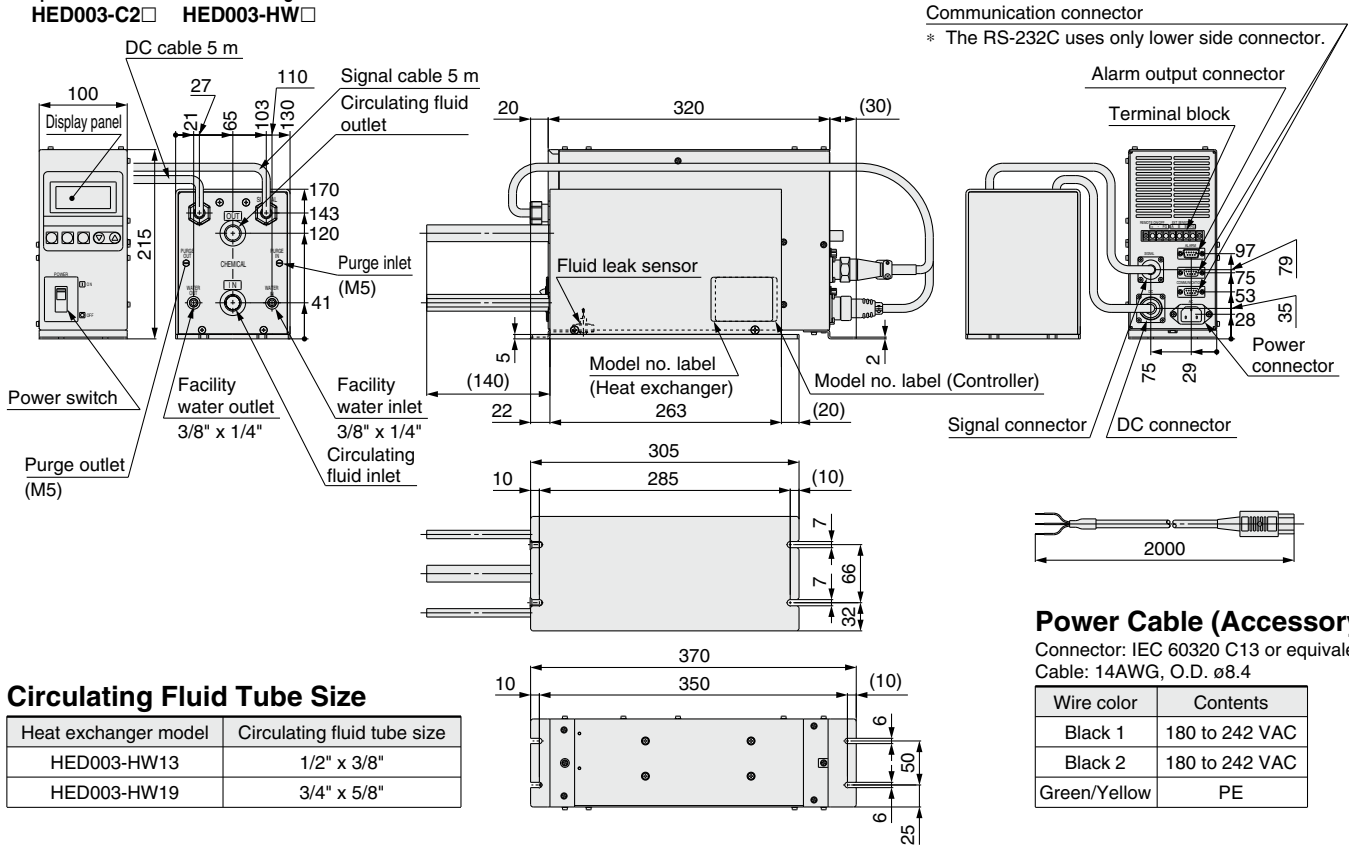

### Circulating Fluid Tube Size

Heat exchanger model	Circulating fluid tube size
HED003-HW13	1/2" x 3/8"
HED003-HW19	3/4" x 5/8"

### HED005-W2□□

Temperature controller Heat exchanger  
HED005-C2□ HED005-HW□

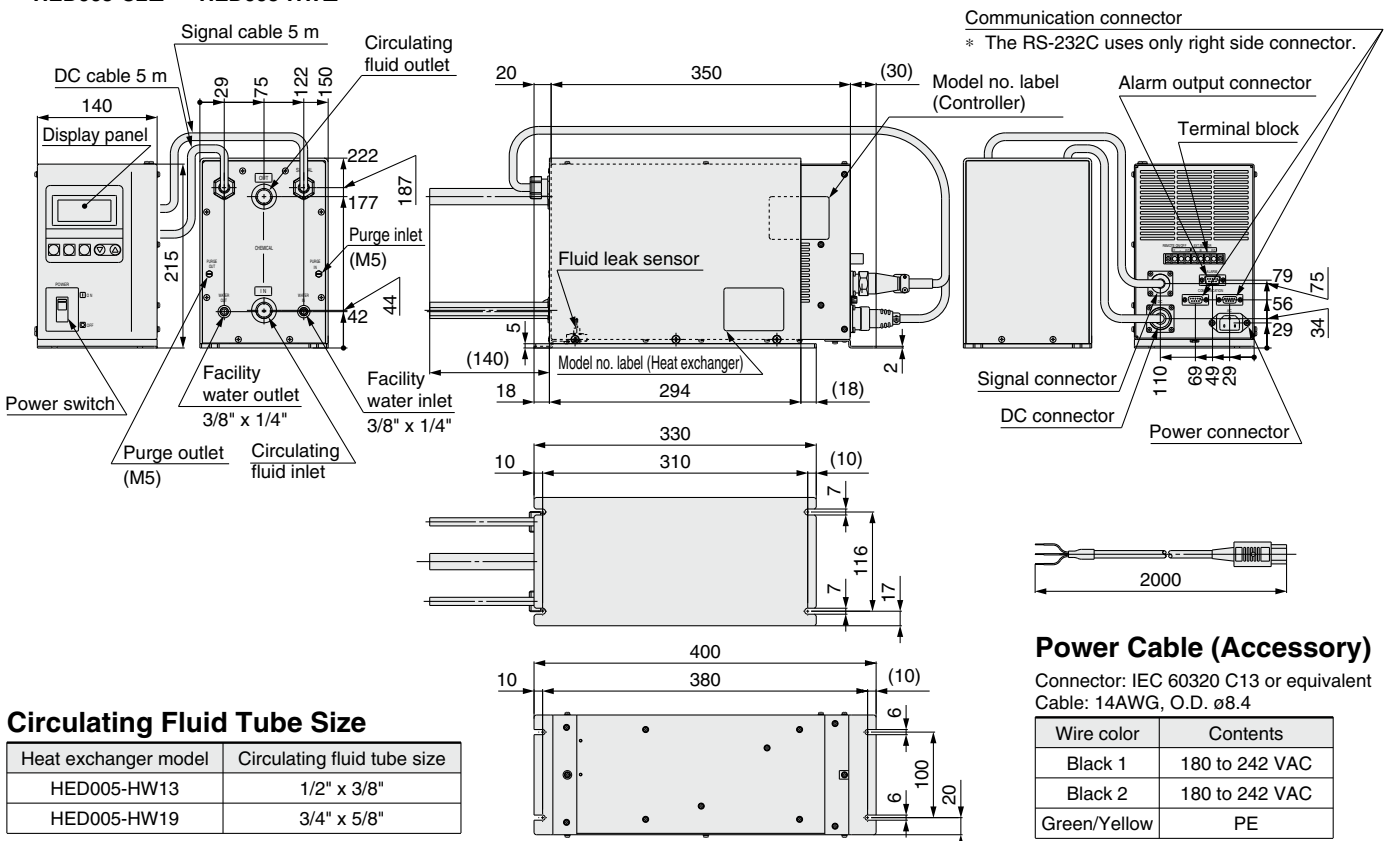

### Circulating Fluid Tube Size

Heat exchanger model	Circulating fluid tube size
HED005-HW13	1/2" x 3/8"
HED005-HW19	3/4" x 5/8"

**Dimensions**

**HED007-W2□□**

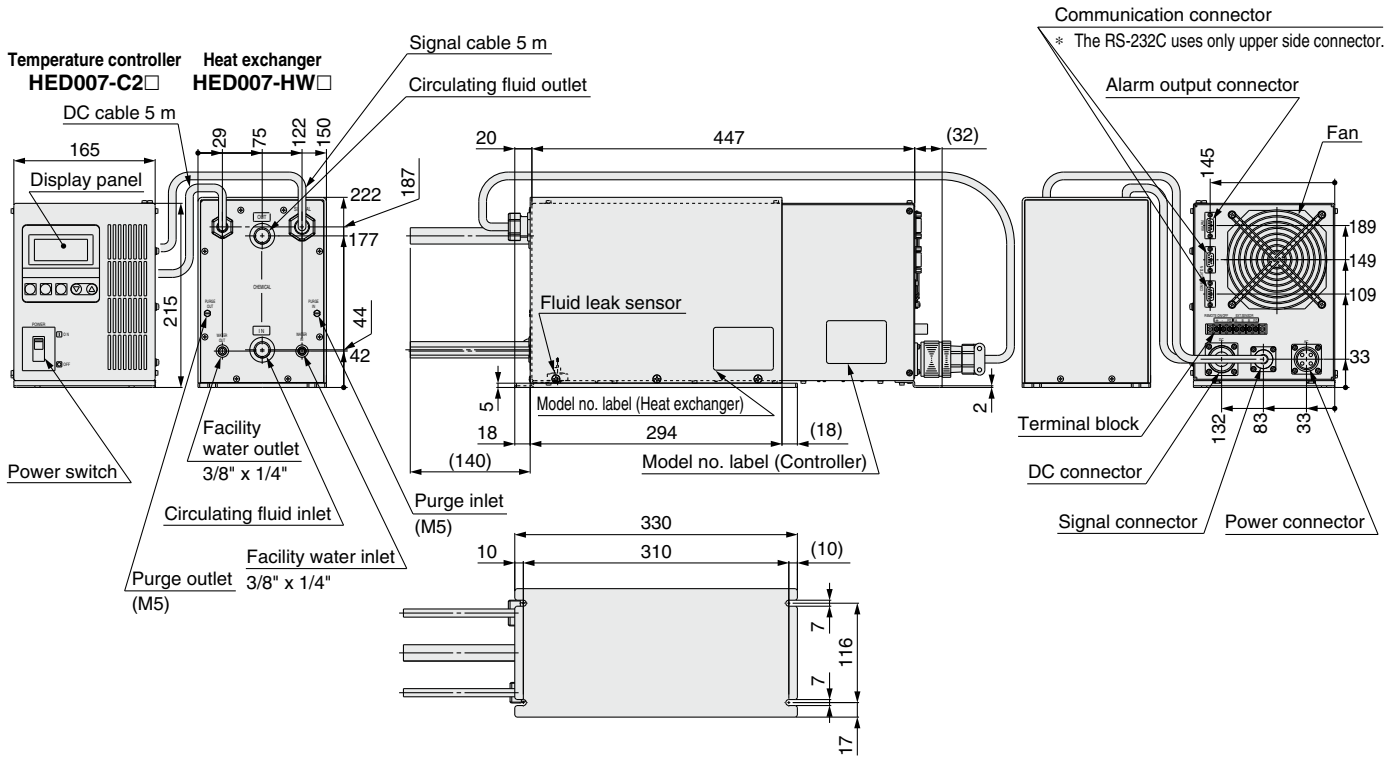

**Circulating Fluid Tube Size**

Heat exchanger model	Circulating fluid tube size
HED007-HW13	1/2" x 3/8"
HED007-HW19	3/4" x 5/8"

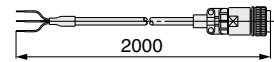
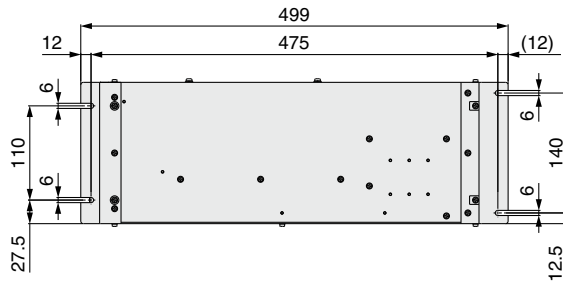

**Power Cable (Accessory)**

Connector: DDK CE05-6A18-10SD-D-BSS  
Cable: 12AWG, O.D. ø11.8

Wire color	Contents
Black 1	180 to 242 VAC
Black 2	180 to 242 VAC
Green/Yellow	PE

- HRS
- HRS090
- HRS100/150
- HRSH090
- HRSH
- HRSE
- HRZ
- HRZD
- HRW
- HECR
- HEC
- HEB
- HED
- Technical Data

## Connectors

- Use the special power cable included with the temperature controller.
- Connect the DC cable and signal cable that come from the heat exchanger to the DC and signal connectors of the temperature controller.
- Prepare other required connectors and wiring by user.

### 1. Power connector

<For HED003-C2□, HED005-C2□>  
IEC 60320 C14 or equivalent

Connect the included special power cable.

Pin No.	Signal contents
1	180 to 242 VAC
2	180 to 242 VAC
3	PE

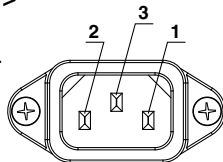

Power connector  
(HED003-C2□, HED005-C2□)

<For HED007-C2□>

DDK Ltd. CE05-2A18-10PD-D

Connect the included special power cable.

Pin No.	Signal contents
A	180 to 242 VAC
B	180 to 242 VAC
C	Unused
D	PE

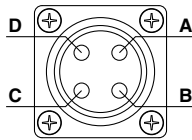

Power connector  
(HED007-C2□)

### 2. DC connector

<For HED003-C2□, HED005-C2□>  
Nanaboshi Electric Mfg. Co., Ltd.:  
NJC-243-RF (UL, CSA)

Connect the DC cable connector of the heat exchanger.

Pin No.	Signal contents
1	DC output
2	DC output
3	FG

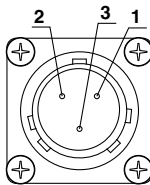

DC connector  
(HED003-C2□, HED005-C2□)

<For HED007-C2□>

DDK Ltd. D/MS3102A20-15S

Connect the DC cable connector of the heat exchanger.

Pin No.	Signal contents
A	DC output
B	DC output
C	DC output
D	DC output
E	DC output
F	DC output
G	FG

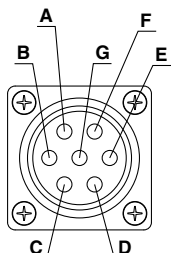

DC connector  
(HED007-C2□)

### 3. Signal connector

<Common to HED003-C2□, HED005-C2□, HED007-C2□>  
Tajimi Electronics Co., Ltd.: TRC01-A16R-10FA

Connect the signal cable connector of the heat exchanger.

Pin No.	Signal contents
1	Thermostat +
2	Thermostat -
3	Terminal A of resistance temperature detector
4	Terminal B of resistance temperature detector
5	Terminal B of resistance temperature detector
6	Fluid leak sensor +24 V
7	Fluid leak alarm signal input
8	Fluid leak 24VE
9-10	Unused
Grounding	FG

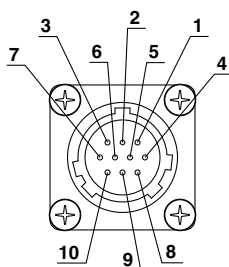

Signal connector

### 4. Terminal block

<Common to HED003-C2□, HED005-C2□, HED007-C2□>  
Morimatsu Co., Ltd.: M111A-7A, for holding screw M3  
Connection cable: 22AWG or more, max. 10 m

Pin No.	Signal contents
1	Remote ON/OFF +
2	Remote ON/OFF -
3	FG
4	External sensor: Terminal A of resistance temperature detector
5	External sensor: Terminal B of resistance temperature detector
6	External sensor: Terminal B of resistance temperature detector
7	FG

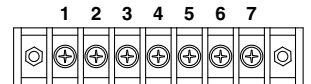

Terminal block

A short pin is installed between No. 1 and No. 2 pins to short-circuit it (Remote ON) when shipped.

#### Remote ON/OFF signal

Circuit voltage: 24 VDC  $\pm$ 10%; passing current: 2.9 to 4.3 mA

#### Exterior sensor signal

Applicable sensor: Pt100  $\Omega$ ; passing current: 2 mA

### 5. Alarm output connector: D-sub 9 pin

<Common to HED003-C2□, HED005-C2□, HED007-C2□>  
OMRON Corp. XM2A-0901 or equivalent, holding screw M2.6  
Fixed contact point (load resistance: 125 VAC, 0.3 A; 30 VDC, 2 A)  
Connection cable: With shielding 22AWG or more, max. 10 m

Pin No.	Signal contents
1	Contact a for output cut-off alarm (open when alarm occurs)
2	Common for output cut-off alarm
3	Contact b for output cut-off alarm (closed when alarm occurs)
4	Contact a for upper/lower temp. limit alarm (open when alarm occurs)
5	Common for upper/lower temp. limit alarm
6	Contact b for upper/lower temp. limit alarm (closed when alarm occurs)
7-9	Unused

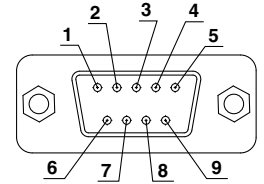

Alarm output connector  
D-sub 9 pin (pin type)

### 6. Communication connector: D-sub 9 pin

OMRON Corp. XM2D-0901 or equivalent, holding screw M2.6  
Connection cable: With shielding 22AWG or more

1) Common to HED003-C2A, HED005-C2A, HED007-C2A  
RS-485

Pin No.	Signal contents
1	RS-485 BUS +
2	RS-485 BUS -
3	Unused
4	Unused
5	SG
6-9	Unused

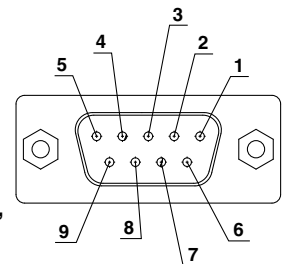

Communication connector  
D-sub 9 pin (socket type)

2) Common to HED003-C2B,  
HED005-C2B,  
HED007-C2B  
RS-232C

Pin No.	Signal contents
1	Unused
2	RS-232C RD
3	RS-232C SD
4	Unused
5	SG
6-9	Unused

## Alarm

This unit has failure diagnosis function. When an failure happens, its failure mode is displayed on the LCD display in the controller and it can be read out through the serial communication, and has relay outputs for upper/lower temperature limit alarm and shutdown alarm.

Alarm code	Alarm description	Operation status	Main reason
WRN	Upper/Lower temp. limit alarm	Continue	The temperature has exceeded the upper or lower limit of the set temperature.
WRN	Remote OFF alarm	Stop	The remote ON/OFF contact is set to be off. (This alarm is not generated by the relay output.)
ERR00	CPU hung-up	Stop	The CPU has crashed due to noise, etc.
ERR01	CPU check failure	Stop	The contents of the CPU cannot be read out correctly when the power supply is turned on.
ERR03	Back-up data error	Stop	The contents of the back-up data cannot be read out correctly when the power supply is turned on.
ERR04	EEPROM writing error	Stop	The data cannot be written to EEPROM.
ERR05	EEPROM input over time error	Stop	The number of times of writing to EEPROM has exceeded the maximum value.
ERR11	DC power voltage failure	Stop	Momentary loss of AC power supply, DC power supply has excessive temperature, or the thermo-module has been short-circuited.
ERR12	Internal sensor value is high.	Stop	The internal temperature sensor has exceeded the upper limit where the Chemical Thermo-con is set to stop.
ERR13	Internal sensor value is low.	Stop	The internal temperature sensor has exceeded the lower limit where the Chemical Thermo-con is set to stop.
ERR14	Thermostat alarm	Stop	The thermostat has been activated due to insufficient flow rate of the circulating fluid or facility water or high temperature.
ERR15	Output failure alarm	Continue	The temperature cannot be changed even at 100% output, due to overload or disconnection of the thermo-module.
ERR17	Cutoff/short of internal sensor	Stop	The internal temperature sensor has been disconnected or short-circuited.
ERR18	Cutoff/short of external sensor	Continued by normal control	The external temperature sensor has been disconnected or short-circuited. (Only detected when in learning control, auto-tuning operation 2, or external sensor control)
ERR19	Auto-tuning failure	Stop	Auto-tuning has not been completed within 60 minutes.
ERR21	Fan alarm	Stop	The air-cooled fan alarm of the power supply has been activated.
ERR22	Leak alarm	Stop	The fluid leak sensor has detected leakage of fluid.

## Maintenance

Please prepare back-up equipment as necessary to minimize the downtime.

### 1) Heat exchanger

The heat exchanger will not be repaired in principle.

Only the return to SMC for an investigation within warranty will be accepted. The return unit has to be completely decontaminated with appropriate method such as use of neutralizing agent before return to SMC.

### 2) Temperature controller

Maintenance of the temperature controller will be performed only at SMC. SMC will not support on-site maintenance. The following parts have published life time. To make a maintenance return schedule is recommended based on the following parts life expectation.

#### Parts Life Expectation

Description	Expected life	Possible failure
Fan	5 to 10 years	Lack of fan cooling because of the life time of the bearing. It will activate the overheat protection of DC power supply and generate alarm.
DC power supply	5 to 10 years	End life of electrolytic condenser. It will generate DC power supply alarm.
Display panel	50,000 hours (approx. 5 years)	End life of backlight of LCD.



## HED Series

# Applicable Fluids

### Chemical Liquid Compatibility Table against the Fluid Contact Material in Chemical Thermo-con

Chemical	Concentration	Operating temperature range	Compatibility
Hydrofluoric acid	HF: 10% or less	10 to 40°C	○*2
Buffered hydrogen fluoride	HF: 10% or less	10 to 40°C	○*2
Hydrofluoric acid and Nitric acid mixture	HF: 5% or less HNO <sub>3</sub> : 5% or less		△
Nitric acid (except fuming nitric acid)	HNO <sub>3</sub> : 5% or less		△
Hydrochloric acid	HCl: 5% or less		△
Copper sulfate solution	H <sub>2</sub> SO <sub>4</sub> : 96% or less	10 to 50°C * HED007 10 to 30°C	○
Sulfuric acid (except fuming sulfuric acid)	H <sub>2</sub> SO <sub>4</sub> : 96% or less	10 to 50°C * HED007 10 to 30°C	○
Ozone	—	10 to 60°C	○
Ammonium hydroxide	NH <sub>3</sub> : 5% or less	10 to 60°C	○*2
Ammonia hydrogen peroxide solution	NH <sub>3</sub> : 5% or less H <sub>2</sub> O <sub>2</sub> : 20% or less	10 to 60°C	○*1, 2
Sodium hydroxide	NaOH: 50% or less	10 to 60°C	○*2
Deionized water	—	10 to 60°C	○*1
Ultrapure water	—	10 to 60°C	○*1

How to read the table:  
○: Useable  
△: Consult with SMC separately.

- The Chemical Liquid Compatibility Table shows reference values only and does not guarantee successful use of chemical liquids in products.
- SMC is not responsible for the accuracy of this data or for any damage arising out of the use of these chemical liquids.
- Chemical Thermo-con is not designed to be explosion proof, so it is not suitable for flammable fluids.

\*1 Static electricity may be generated. Anti-static electricity countermeasures should be implemented.  
Flow friction may generate static electricity, which can cause electric discharge to the temperature sensor or other devices and cause a malfunction.  
It is possible to discharge electricity by using a conductive PFA tube, metal piping (metal flexible hose), or other type of tubing, and by installing a ground line.

\*2 Permeation of the fluid may be possible. The permeated fluid may have a moderate corrosion to inside components and it may effect their life time. If the chemical liquid has high concentration, permeation becomes greater, which effects the service life. In case the fluid has a possibility to generate corrosive gas, SMC recommends a nitrogen purge of the enclosure. N<sub>2</sub> purge ports are located at the piping connection side of the heat exchanger.



# HED Series

## Specific Product Precautions 1

Be sure to read this before handling the products. Refer to page 383 for safety instructions and pages 384 to 387 for temperature control equipment precautions.

### Design

#### Warning

This catalog shows the specifications of the Chemical Thermo-con.

1. Check detailed specifications in the separate “Product Specifications”, and evaluate the compatibility of the Chemical Thermo-con with the user’s system.
2. The Chemical Thermo-con is equipped with a protective circuit independently, but the whole system should be designed by user to ensure safety.

### Handling

#### Warning

1. Thoroughly read the Operation Manual.

Read the Operation Manual completely before operation, and keep this manual available whenever necessary.

### Operating Environment/Storage Environment

#### Warning

1. Keep within the specified ambient temperature and humidity range. Also, if the set temperature is too low, condensation may form on the inside of the Chemical Thermo-con or the surface of piping even within the specified ambient temperature range. Dew condensation can cause failure, and so must be avoided by considering operating conditions.
2. The Chemical Thermo-con is not designed for clean room usage. The fan will generate dust.
3. Low molecular siloxane can damage the contact of the relay. Use the Chemical Thermo-con in a place free from low molecular siloxane.

### Piping

#### Warning

1. Piping must be designed taking the whole system into consideration.

For this product and future equipment, design of the piping system should be performed by a knowledgeable and experienced person.

The fitting is not attached, and should be prepared separately by user.

Select a fitting suitable for the material and dimensions of the tube. When connecting the fitting, use a specific tool specified by fitting manufacturer.

### Piping

#### Warning

2. Work performed on the piping should be done by a knowledgeable and experienced person.

If work performed on the piping is done by a less knowledgeable and inexperienced person, it will likely lead to operating fluid leakage, etc.

3. Confirm the leakage of fluid.

Fluid leakage can cause dangerous accidents. Be sure to confirm that the hose or tubing is not pulled out and that there is no leakage in the fitted parts.

4. Confirm that the resin tube is not kinked or collapsed.

If a resin tube is used, it should be checked for the presence and possibility of kink or collapse.

5. Countermeasures against fluid leakage

Water drops may accumulate due to leakage of circulating fluid or facility water, or condensation on the piping. Install the Chemical Thermo-con with a drip pan, fluid leak sensor and exhaust system.

If leakage is detected, cut off the circulating pump with a hardware interlock, and cut off the power to the Chemical Thermo-con.

Depending on the type of chemical used (circulating fluid), it may have a harmful effect on the surrounding equipment and the human body.

#### Caution

1. Before piping

Confirm that dust, scales, etc., in contact with piping is cleaned up or air blown (flushing) before piping.

2. Take care over the direction of fluid.

Do not mistake the direction of “IN” and “OUT” for the facility water system and circulating fluid system.

3. Take countermeasures against condensation.

Depending on the operating condition, condensation may occur on the piping. In such a case, take countermeasures such as installing insulation material, etc.

4. Avoid electrostatic discharge.

If a fluid with low conductivity such as deionized water is used as the circulating fluid, static electricity generated by flow friction may be discharged to the temperature sensor and malfunction the Chemical Thermo-con. Consider measures to minimize the discharge of static electricity from the circulating fluid to signal line including the temperature sensor.

For example, a PFA conductive tube or metal piping (metal flexible hose) can be used to provide grounding to the piping of the external sensor and to discharge.

HRS

HRS090

HRS100/150

HRS090

HRS

HRS

HRS

HRS

HRS

HECR

HEC

HEB

HED

Technical Data



## HED Series

# Specific Product Precautions 2

Be sure to read this before handling the products. Refer to page 383 for safety instructions and pages 384 to 387 for temperature control equipment precautions.

### Electrical Wiring

#### Warning

##### 1. Electrical wiring job should be performed by a knowledgeable and experienced person.

Power supply facilities and wiring works should be implemented in accordance with the electric facilities technical standards and provisions and conducted correctly.

##### 2. Mounting a dedicated earth leakage breaker.

As a countermeasure against current leakage, install an earth leakage breaker in the main power supply.

##### 3. Confirmation of power supply

If this product is used with voltages other than specified, it will likely lead to a fire or an electrical shock. Before wiring, confirm the voltage, capacity, and frequency.

Confirm that the voltage fluctuation is within the specified value.

##### 4. Grounding

Be sure to ground (frame ground) with class D grounding. (grounding resistance of 100 Ω or less)

Can be grounded with the PE line of the power supply cable.

Also, do not use together with equipment that generates a strong electrical magnetic noise or high frequency noise.

##### 5. Wiring cable should be handled with care.

Do not bend, twist or pull the cord or cable.

##### 6. Wire with an applicable cable size and terminal.

In the event of attaching a power supply cable, use a cable and terminal size which is suitable for the electrical current of each product.

Forcibly mounting with an unsuitable size cable will likely result in a fire.

##### 7. Avoid wiring the signal line and power line in parallel.

Since there may be a possibility of malfunction from noise, avoid parallel wiring between the temperature sensor line, communications line, signal line of alarm line, etc. and the power line and high voltage line. Also, do not place them in the same wiring tube.

##### 8. Check for incorrect wiring.

Incorrect wiring can damage the Chemical Thermo-con or cause malfunction. Be sure to check wiring is connected properly.

##### 9. Check the model of the Chemical Thermo-con.

The HED003 and HED005 series use the same connector. If the temperature controller and heat exchanger of different models are combined by mistake, an alarm may be generated and the specified performance may not be obtained. Be sure to check the combination of models.

### Facility Water Supply

#### Warning

##### 1. Be sure to supply the facility water.

1. Prohibition of water-cut operation, very little flow rate of water operation.

Do not operate under the condition that there is no facility water or where there is very little flow rate of water is flowing. (Facility water flow rate range: 5 to 10 L/min)

In this kind of operation, facility water temperature may become extremely higher. It is dangerous enough the material of hose may soften and burst when the piping supplying the facility water is connected with hose.

2. Actions to be taken when an emergency stop occurs due to extremely high temperature.

In case a stop occurs due to extremely high temperature resulting from a decrease in the facility water flow rate, do not immediately flow facility water. It is dangerous enough the material of hose may soften and burst when the piping supplying the facility water is connected with hose. First, naturally let it cool down, and removing the cause of the flow rate reduction. Secondly, make sure that there is no leakage again.

#### Caution

##### 1. Facility water quality

1. Use the facility water within the specified range.

When using with other fluid than facility water, please consult with SMC.

2. When it is likely that foreign matter may enter the fluid, install a filter (20 mesh or equivalent).

##### Facility Water Quality Standards

The Japan Refrigeration and Air Conditioning Industry Association

JRA GL-02-1994 "Cooling water system – Circulating type – Circulating water"

	Item	Standard value
Standard item	pH (at 25°C)	6.5 to 8.2
	Electric conductivity (25°C)	100*1 to 800 [μS/cm]
	Chloride ion	200 [mg/L] or less
	Sulfuric acid ion	200 [mg/L] or less
	Acid consumption amount (at pH4.8)	100 [mg/L] or less
	Total hardness	200 [mg/L] or less
	Calcium hardness	150 [mg/L] or less
Reference item	Ionic state silica	50 [mg/L] or less
	Iron	1.0 [mg/L] or less
	Copper	0.3 [mg/L] or less
	Sulfide ion	Should not be detected.
	Ammonium ion	1.0 [mg/L] or less
	Residual chlorine	0.3 [mg/L] or less
	Free carbon	4.0 [mg/L] or less

\*1 Electric conductivity should be 100 [μS/cm] or more.

##### 2. If the temperature of the facility water is too low, it can cause formation of condensation inside the heat exchanger.

Supply facility water with a temperature over the atmospheric dew point to avoid the formation of dew condensation.

##### 3. If the facility water piping is connected to multiple machines, the facility water exchanges heat at the upstream side and its temperature will become higher as it goes downstream.

Limit the number of connected Chemical Thermo-cons to two per facility water system, and if two Chemical Thermocons or more are to be connected, increase the number of systems.





# HED Series

## Specific Product Precautions 3

Be sure to read this before handling the products. Refer to page 383 for safety instructions and pages 384 to 387 for temperature control equipment precautions.

### Mounting

#### ⚠ Caution

##### 1. Mount and install horizontally.

When mounting, fix the foot of the Chemical Thermo-con by tightening the screws to the specified torque below.

##### Recommended Mounting Torque

Device to mount	Thread size	Applicable tightening torque N·m
Heat exchanger	M6	1.5 to 2.5
Temperature controller	M5	1.5 to 2.5

### Circulating Fluid

#### ⚠ Caution

##### 1. Applicable fluids

For the compatibility between the material of components and fluid, refer to "Applicable Fluids" (page 369). Please contact SMC for fluids other than those described on the check list.

##### 2. Caution for the use of fluids with high permeation

When the Chemical Thermo-con is used for a fluid with high permeation into fluorine resin, the permeation can affect its life. If the fluid also generates corrosive gas, perform N<sub>2</sub> supply and exhaust (N<sub>2</sub> purge) inside the heat exchanger.

##### 3. Caution for the use of deionized water

If deionized water is used, bacteria and algae may grow in a short period. If the Chemical Thermo-con is operated with bacteria and algae, the performance of the heat exchanger may deteriorate. Exchange all deionized water regularly depending on the conditions (once a month as a guide).

##### 4. Prohibition of small flow rate

Be sure to avoid operation with the circulating pump stopped or with extremely small flow rate of recirculating fluid (7 L/min or less for water). Otherwise, the Chemical Thermo-con will repeat change cooling and heating operation, which may shorten the life of the Peltier element significantly, and it will become unable to control the temperature accurately. When the circulating pump is stopped, stop the temperature control of the Chemical Thermo-con as well by using the remote ON/OFF function.

##### 5. Operating pressure range of circulating fluid

The operating pressure range is 0 to 0.35 MPa. Do not use with negative pressure which can cause the Chemical Thermo-con to fail. (Specifically, install the heat exchanger at the secondary (discharge) side of the circulating pump.) Also, avoid excessive pressure being applied to the circulating fluid circuit by a clogged filter or fully closed valve.

##### 6. Prohibition of fluid pulsation

If a pump generating pulsation is used, install a damper to absorb the pulsation directly before the Chemical Thermo-con. Fluid pulsation can break the Chemical Thermo-con.

### Communication

#### ⚠ Caution

##### 1. The set value can be written to EEPROM, but only up to approx. 1 million times.

In particular, pay attention to how many of times the writing is performed using the communication function.

### Maintenance

#### ⚠ Warning

##### 1. Prevention of electric shock and fire

Do not operate the switch with wet hands. Also, do not operate the Chemical Thermo-con with water or fluid left on it.

##### 2. Action in the case of error

If any error such as abnormal noise, smoke, or bad smell occurs, cut off the power at once, and stop supplying facility water. Please contact SMC or a sales distributor to repair the Chemical Thermo-con.

##### 3. Regular inspection

Check the following items at least once a month. The inspection must be done by an operator who has sufficient knowledge and experience.

- Check of displayed contents.
- Check of temperature, vibration and abnormal sounds in the body of the Chemical Thermo-con.
- Check of the voltage and current of the power supply system.
- Check for leakage and contamination of the circulating fluid and intrusion of foreign matter to it, and subsequent replacement water.
- Check for leakage, quality change, flow rate and temperature of facility water.

##### 4. Wearing of protective clothing

Some fluids can be dangerous when handled incorrectly. Wear protective clothing for safety during maintenance. In particular, observe the MSDS of the circulating fluid, and wear protective goggles, gloves and mask for the operation of the Chemical Thermo-con accompanied with the use of fluids.



Goggles



Mask



Gloves



Safety shoes

HRS

HRS090

HRS100/150

HRS090

HRS

HRS

HRS

HRS

HRS

HRS

HRS

HRS

HRS

HRS

Technical Data