

- Совместимые серии пневмораспределителей: SY3000/5000, SV1000/2000/3000, VQC1000/2000/4000, S0700
- Толщина 28.2 мм (для сравнения, у EX250 – 81 мм)
- Поддерживает протоколы Profibus DP, DeviceNet, CC-Link, EtherCAT, PROFINET, EtherNet/IP™
- Разъемы D-sub или M12
- Степень защиты IP67 (у исполнения с разъемом D-sub – IP40)
- Возможность управления распределителями с общим (+) и общим (-)
- Возможность выбора 16 или 32 катушек распределителей
- Не требуется «тройник» для подключения к промышленной сети
- Встроенный терминальный резистор с переключателем у исполнений для протоколов Profibus DP и CC-Link с разъемом M12



Номер для заказа

Номер для заказа	Протокол	Кол-во выходов	Тип выхода	Разъем для подключения к промышл. сети
EX260-SDN1	DeviceNet™	32	PNP	M12
EX260-SDN2			NPN	
EX260-SDN3		16	PNP	
EX260-SDN4			NPN	
EX260-SPR1	PROFIBUS DP	32	PNP	M12
EX260-SPR2			NPN	
EX260-SPR3		16	PNP	
EX260-SPR4			NPN	
EX260-SPR5		D-sub	32	PNP
EX260-SPR6				NPN
EX260-SPR7			16	PNP
EX260-SPR8				NPN
EX260-SMJ1	CC-Link	32	PNP	M12
EX260-SMJ2			NPN	
EX260-SMJ3		16	PNP	
EX260-SMJ4			NPN	
EX260-SEC1	EtherCAT	32	PNP	M12
EX260-SEC2			NPN	
EX260-SEC3		16	PNP	
EX260-SEC4			NPN	
EX260-SPN1	PROFINET	32	PNP	M12
EX260-SPN2			NPN	
EX260-SPN3		16	PNP	
EX260-SPN4			NPN	
EX260-SEN1	EtherNet/IP™	32	PNP	M12
EX260-SEN2			NPN	
EX260-SEN3		16	PNP	
EX260-SEN4			NPN	



*В комплект поставки входит влагозащитный колпачок M12 (только для модулей с разъемом M12 для подключения к промышленной сети) и 2 установочных винта

Совместимые пневмораспределители

Серия	Объемный расход (норм.л/мин.)	Ø пневмоцилиндра (справочное значение)	Мак. количество катушек	Потребляемая мощность (Вт)	Степень защиты
SY3000/5000	440/980	Ø80/Ø125	32	Стандарт: 0.35 С энергосбер. схемой: 0.1	IP67
SV1000/2000/3000	300/650/1170	Ø40/Ø63/Ø80	32	0.6	
VQC1000/2000/4000	270/870/1990	Ø40/Ø63/Ø100	24	VQC1000/2000: 0.4 VQC4000: 1.0	
S0700	100	Ø25	32	0.35	IP40

Принадлежности (заказываются отдельно)

Наименование	Номер для заказа	Примечание
Кабель питания 1 м с прямым разъемом M12	EX500-AP010-S	Для PROFIBUS DP, DeviceNet™, EtherCAT, PROFINET, EtherNet/IP™
Кабель питания 1 м с угловым разъемом M12	EX500-AP010-A	
Кабель питания 5 м с прямым разъемом M12	EX500-AP050-S	
Кабель питания 5 м с угловым разъемом M12	EX500-AP050-A	
Кабель питания 1.5 м с разъемом M12-SPEEDCON	PCA-1401804	
Кабель питания 3 м с разъемом M12-SPEEDCON	PCA-1401805	
Кабель питания 5 м с разъемом M12-SPEEDCON	PCA-1401806	Для CC-Link
Кабель питания 1 м с прямым разъемом M12	EX9-AC010-1	
Кабель питания 3 м с прямым разъемом M12	EX9-AC030-1	
Кабель питания 5 м с прямым разъемом M12	EX9-AC050-1	
Кабель питания 1.5 м с разъемом M12-SPEEDCON	PCA-1401807	
Кабель питания 3 м с разъемом M12-SPEEDCON	PCA-1401808	
Кабель питания 5 м с разъемом M12-SPEEDCON	PCA-1401809	
Кабель передачи данных	По запросу	–
Комплект влагозащитных колпачков M12 (10 шт.)	EX9-AWTS	–

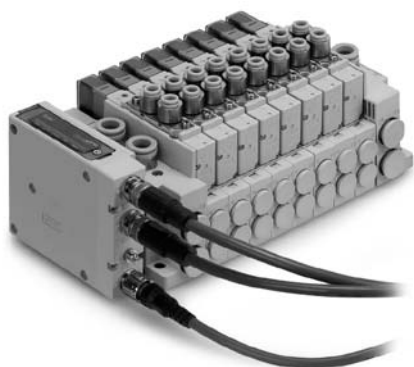

Технические характеристики

Номер для заказа		EX260-SPR1 EX260-SPR3	EX260-SPR2 EX260-SPR4	EX260-SPR5 EX260-SPR7	EX260-SPR6 EX260-SPR8	EX260-SDN1 EX260-SDN3	EX260-SDN2 EX260-SDN4	EX260-SMJ1 EX260-SMJ3	EX260-SMJ2 EX260-SMJ4
Сетевой протокол		PROFIBUS DP				DeviceNet™		CC-Link	
Версия		DP-VO				Volume 1 (Edition 3.5) Volume 3 (Edition 1.5)		Ver.1.10	
Файл конфигурации ²⁾		GSD				EDS		-	
Количество входов/выходов		SPR1: 0/32 SPR3: 0/16	SPR2: 0/32 SPR4: 0/16	SPR5: 0/32 SPR7: 0/16	SPR6: 0/32 SPR8: 0/16	SDN1: 0/32 SDN3: 0/16	SDN2: 0/32 SDN4: 0/16	SMJ1: 32/32 SMJ3: 32/32 (1 секция , модули удаленных вх/вых)	SMJ2: 32/32 SMJ4: 32/32 (1 секция , модули удаленных вх/вых)
Поддерживаемые скорости передачи данных		9.6, 19.2, 45.45, 93.75, 187.5, 500 кбит/с 1.5, 3, 6, 12 Мбит/с				125, 250, 500 кбит/с		156, 625 кбит/с 2.5, 5, 10 Мбит/с	
Питание	Цепи управления	21.6 ~ 26.4 VDC, потребление не более 100 mA				-		21.6 ~ 26.4 VDC, потребление не более 100 mA	
	Выходов	22.8 ~ 26.4 VDC							
	Интерфейса	-				11 ~ 25 VDC, потребление не более 100 mA		-	
Разъем для подключения к промышленной сети		M12		D-sub		M12			
Терминальный резистор		Встроенный		-				Встроенный	
Выходы	Тип	PNP	NPN	PNP	NPN	PNP	NPN	PNP	NPN
	Количество	SPR1: 32 SPR3: 16	SPR2: 32 SPR4: 16	SPR5: 32 SPR7: 16	SPR6: 32 SPR8: 16	SDN1: 32 SDN3: 16	SDN2: 32 SDN4: 16	SMJ1: 32 SMJ3: 16	SMJ2: 32 SMJ4: 16
	Нагрузка	Пневмораспределитель SMC с электроуправлением, с искрогашением, 24 VDC, не более 1.5 Вт							
	Напряжение (VDC)	24							
	Ток (A)	SPR1: ≤ 2 SPR3: ≤ 1	SPR2: ≤ 2 SPR4: ≤ 1	SPR5: ≤ 2 SPR7: ≤ 1	SPR6: ≤ 2 SPR8: ≤ 1	SDN1: ≤ 2 SDN3: ≤ 1	SDN2: ≤ 2 SDN4: ≤ 1	SMJ1: ≤ 2 SMJ3: ≤ 1	SMJ2: ≤ 2 SMJ4: ≤ 1
Степень защиты		IP67		IP40		IP67			
Рабочая температура (°C)		-10 ~ 50							
Относительная влажность		35 ~ 85%, при низких температурах использовать сухой воздух							
Электрическая прочность изоляции		Устойчивость к воздействию испытательного напряжения 500 VAC, приложенного в течение 1 мин. между проводящими частями и корпусом							
Сопротивление изоляции		Между любым контактом и корпусом не менее 10 МОм (при 500 V DC)							
Устойчивость к вибрации		10 ~ 57 Гц с постоянной амплитудой 0.75 мм; 57 ~ 150 Гц с постоянным ускорением 49м/с ² , в трех измерениях длительностью до двух часов (в выключенном состоянии)							
Устойчивость к ударам		147 м/с ²							
Вес (г)		Не более 200							

Номер для заказа		EX260-SEC1 EX260-SEC3	EX260-SEC2 EX260-SEC4	EX260-SPN1 EX260-SPN3	EX260-SPN2 EX260-SPN4	EX260-SEN1 EX260-SEN3	EX260-SEN2 EX260-SEN4
Сетевой протокол		EtherCAT ¹⁾		PROFINET ¹⁾		EtherNet/IP™ ¹⁾	
Версия		Conformance Test Record V. 1.1		PROFINET Specification Version 2.2		Volume 1 (Edition 3.8) Volume 2 (Edition 1.9)	
Файл конфигурации ²⁾		XML		GSD		EDS	
Количество входов/выходов		SEC1: 0/32 SEC3: 0/16	SEC2: 0/32 SEC4: 0/16	SPN1: 0/32 SPN3: 0/16	SPN2: 0/32 SPN4: 0/16	SEN1: 16/32 SEN3: 16/16	SEN2: 16/32 SEN4: 16/16
Поддерживаемые скорости передачи данных		100 Мбит/с ¹⁾				10, 100 Мбит/с ¹⁾	
Питание	Цепи управления	21.6 ~ 26.4 VDC, потребление не более 100 мА					
	Выходов	22.8 ~ 26.4 VDC					
	Интерфейса	–					
Разъем для подключения к промышленной сети		M12					
Терминальный резистор		–					
Выходы	Тип	PNP	NPN	PNP	NPN	PNP	NPN
	Количество	SEC1: 32 SEC3: 16	SEC2: 32 SEC4: 16	SPN1: 32 SPN3: 16	SPN2: 32 SPN4: 16	SEN1: 32 SEN3: 16	SEN2: 32 SEN4: 16
	Нагрузка	Пневмораспределитель SMC с электроуправлением, с искрогашением, 24 VDC, не более 1.5 Вт		Пневмораспределитель SMC с электроуправлением, с искрогашением, 24 VDC, не более 1.0 Вт		Пневмораспределитель SMC с электроуправлением, с искрогашением, 24 VDC, не более 1.5 Вт	
	Напряжение (VDC)	24					
	Ток (A)	SEC1: ≤ 2 SEC3: ≤ 1	SEC2: ≤ 2 SEC4: ≤ 1	SPN1: ≤ .2 SPN3: ≤ 1	SPN2: ≤ 2 SPN4: ≤ 1	SEN1: ≤ 2 SEN3: ≤ 1	SEN2: ≤ 2 SEN4: ≤ 1
Степень защиты		IP67					
Рабочая температура (°C)		–10 ~ 50					
Относительная влажность		35 ~ 85%, при низких температурах использовать сухой воздух					
Электрическая прочность изоляции		Устойчивость к воздействию испытательного напряжения 500 VAC, приложенного в течение 1 мин. между проводящими частями и корпусом					
Сопrotивление изоляции		Между любым контактом и корпусом не менее 10 МОм (при 500 V DC)					
Устойчивость к вибрации		10 ~ 57 Гц с постоянной амплитудой 0.75 мм; 57 ~ 150 Гц с постоянным ускорением 49м/с ² , в трех измерениях длительностью до двух часов (в выключенном состоянии)					
Устойчивость к ударам		147 м/с ²					
Вес (г)		Не более 200					

1) Для EtherCAT, PROFINET и EtherNet/IP™ используйте Ethernet кабель категории не хуже, чем CAT5

2) Файлы конфигурации могут быть загружены с сайта SMC <http://www.smcworld.com/>

Размеры

Интерфейсный модуль с разъемом M12

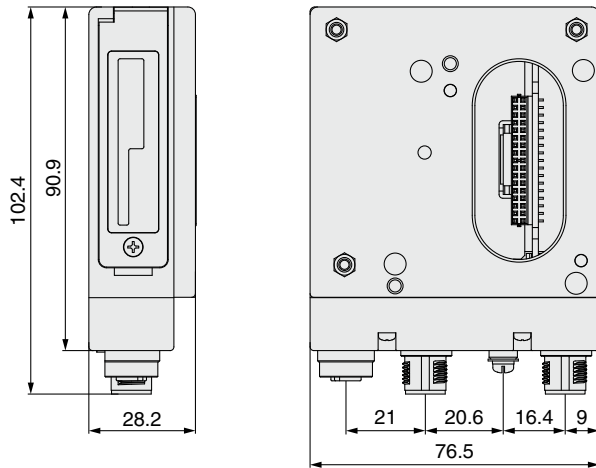

Интерфейсный модуль с разъемом D-sub

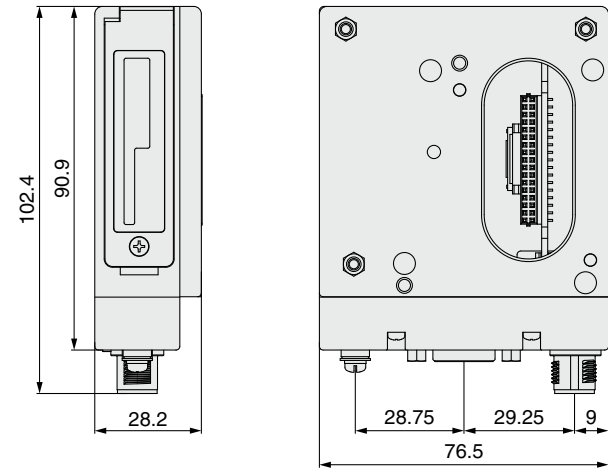

Внешний вид

Индикаторы и настройка



Примечание
Подробная информация приведена в Руководстве по эксплуатации

Назначение разъемов

Интерфейсный модуль с разъемом M12

Номер для заказа	EX260-SPR1/-SPR2 -SPR3/-SPR4	EX260-SDN□	EX260-SMJ□	EX260-SEC□ EX260-SPN□ EX260-SEN□
Протокол	PROFIBUS DP	DeviceNet™	CC-Link	EtherCAT PROFINET EtherNet/IP™
Разъем передачи данных (M12) BUS OUT	5 конт., розетка, В-код	5 конт., розетка, А-код	5 конт., розетка, А-код	4 конт., розетка, D-код
Разъем передачи данных (M12) BUS IN	5 конт., вилка, В-код	5 конт., вилка, А-код	4 конт., вилка, А-код	4 конт., розетка, D-код
Винт заземления	M3			
Разъем M12 для питания пневмоострова	5 конт., вилка, А-код	4 конт., вилка, А-код	5 конт., вилка, В-код	5 конт. ¹⁾ , 4 конт. ²⁾ , вилка, А-код

1) Для EtherCAT, PROFINET
2) Для EtherNet/IP™

Интерфейсный модуль с разъемом D-sub

Номер для заказа	EX260-SPR5/-SPR6/-SPR7/-SPR8
Протокол	PROFIBUS DP
Винт заземления	M3
Разъем передачи данных (D-sub) BUS IN/OUT	9 конт., розетка
Разъем M12 для питания пневмоострова	5 конт., вилка, А-кодировка

Принадлежности

Кабель питания с разъемом M12

Для PROFIBUS DP, DeviceNet™, EtherCAT, PROFINET, EtherNet/IP™

EX500 – AP 050 – S

Длина (L)		Разъем	
010	1000 мм	S	Прямой
050	5000 мм	A	Угловой

Прямой разъем

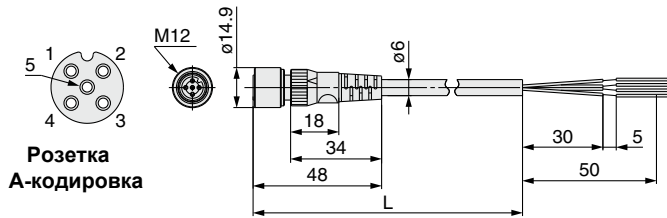

Угловой разъем

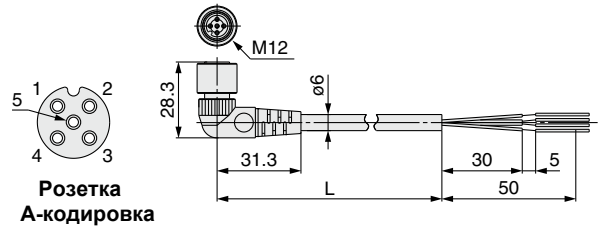

SPEEDCON

РСА-1401804

Длина (L)	
1401804	1500 мм
1401805	3000 мм
1401806	5000 мм

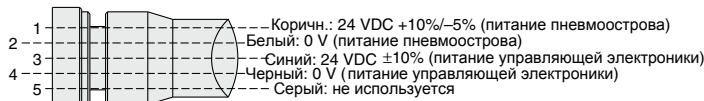
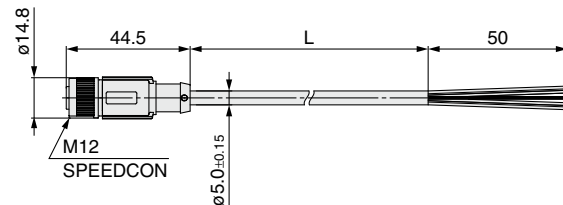

Подключение для PROFIBUS DP/EtherCAT

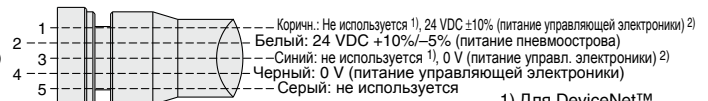

Подключение для DeviceNet™, EtherNet/IP™

1) Для DeviceNet™
2) Для EtherNet/IP™

Для CC-Link

Прямой разъем

EX9 – AC 050 – 1

Длина (L)	
010	1000 мм
030	3000 мм
050	5000 мм

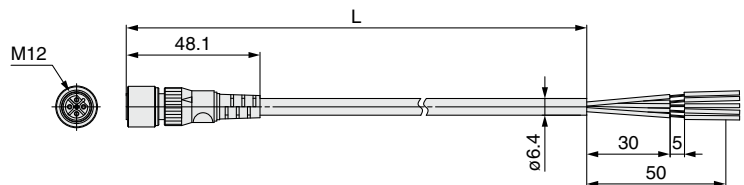
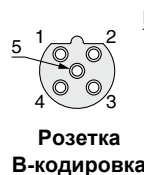

SPEEDCON

РСА-1401807

Длина (L)	
1401807	1500 мм
1401808	3000 мм
1401809	5000 мм

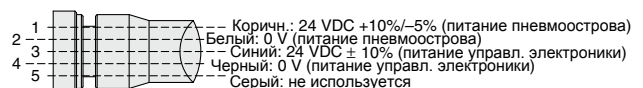
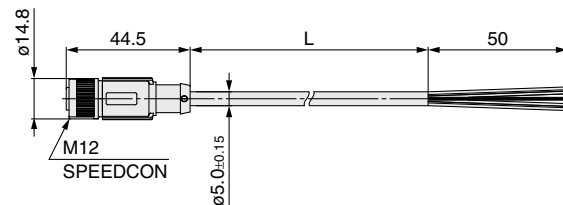

Влагозащитный колпачок

Устанавливается на неиспользуемые разъемы для подключения к промышленной сети M12.

Обеспечивает степень защиты IP67.

Рекомендуемый момент затяжки резьбы 0.1 Нм.

EX9 – AW TS (номер для заказа комплекта из 10 колпачков)

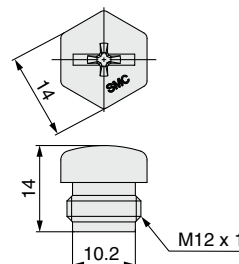

Fieldbus System

(Output device for driving 5 port solenoid valves)

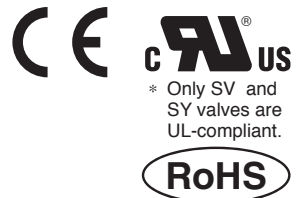

Compact
28 mm
(Actual size)

Space-saving Installation



• **IP67***

* For units with D-sub connector, and when connected to S0700 manifolds, it is IP40.

• **Drives up to 32 solenoids**

Daisy-chain wiring communication

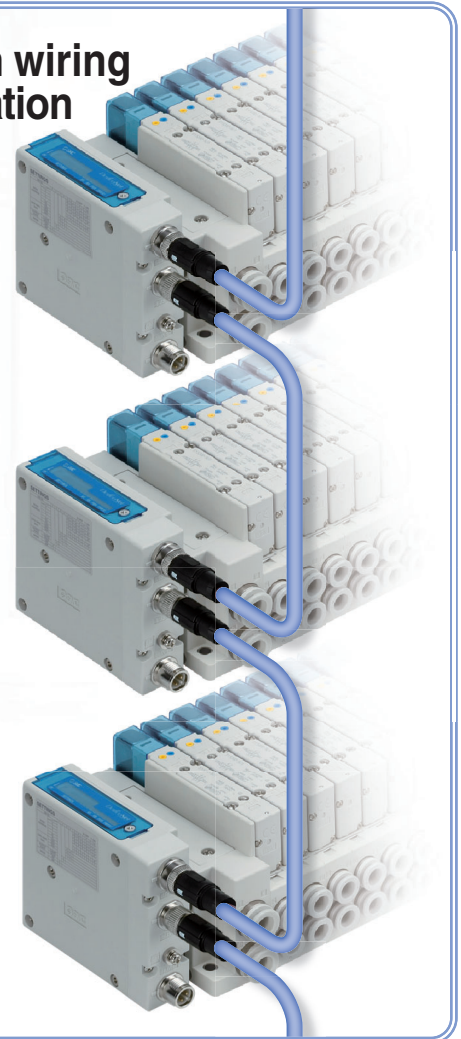

Compatible Protocols



Made to Order IO-Link AS-Interface Modbus CANopen
Please contact SMC for details on compatible products.

Top ported valve



IP67

SY3000/5000/7000 Series

Bottom ported valve



IP67

SY3000/5000/7000 Series

Side ported valve Mixed valve sizes manifold



IP67

SY3000/5000/7000 Series

7 mm width valve



IP40

S0700 Series

EX260 Series



CAT.EU02-25Bb-UK

Manifold length is shortened by the small fieldbus output module (SI unit).

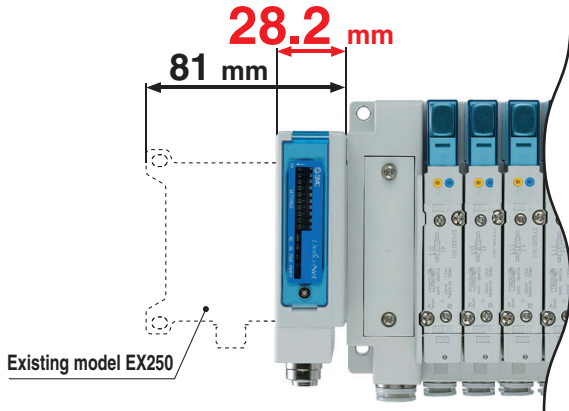

Wiring and piping from the same direction is possible. (for side ported)
Can be installed in locations where space above the valve is limited

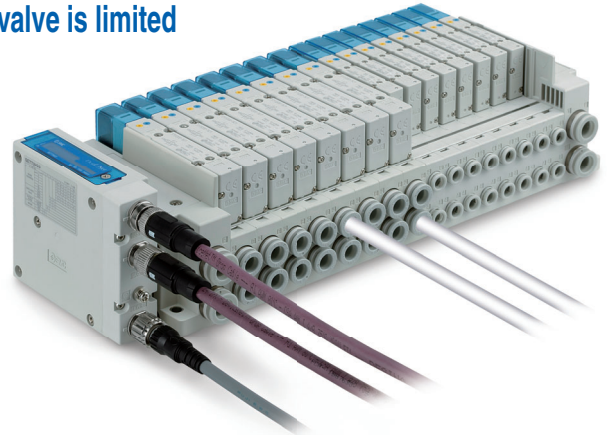

External branch connector is not necessary. Daisy-chain wiring is possible. Reduced wiring space

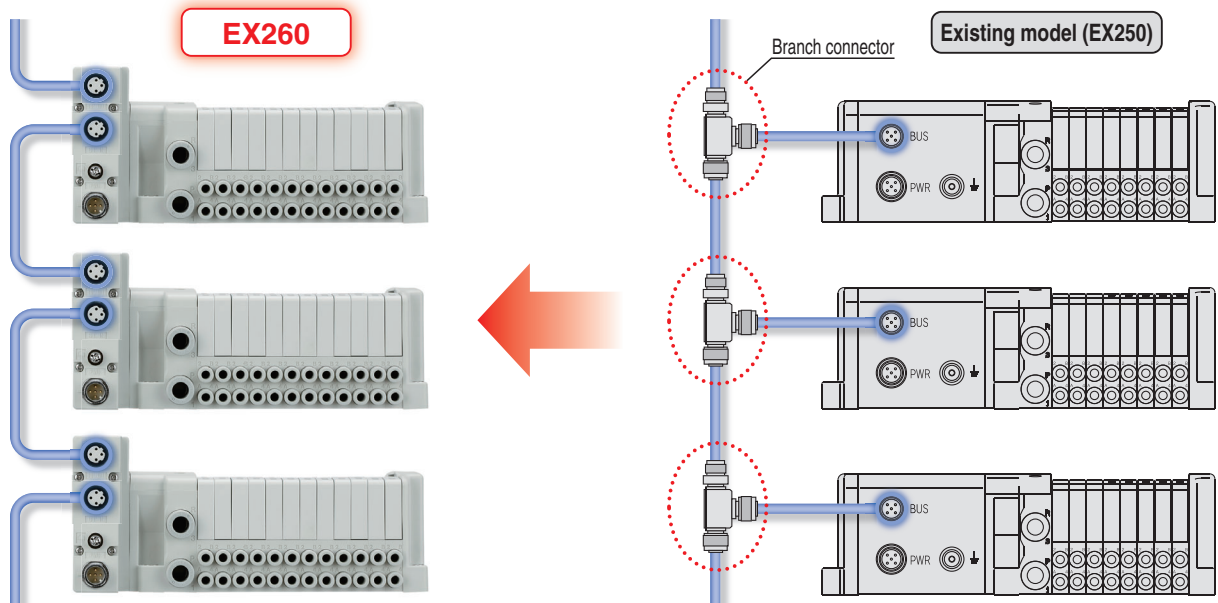

External terminating resistor is not necessary.

(Only available for M12 PROFIBUS DP, CC-Link communication connectors)

ON/OFF switching is possible with an internal terminating resistor. External terminating resistor is not necessary.

External terminating resistor

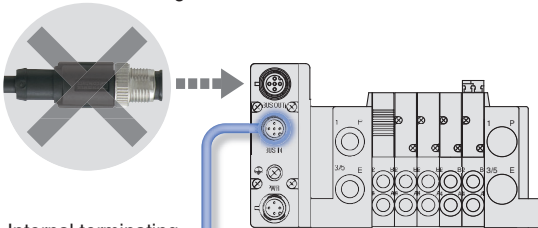

Internal terminating resistor

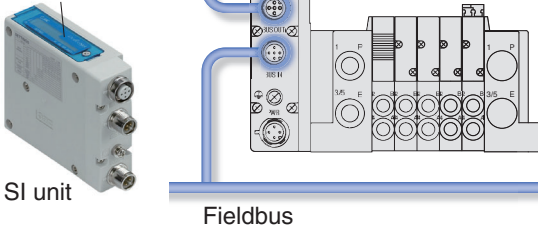

Product Specification Variations

	PROFIBUS [®]	DeviceNet	CC-Link	PROFIBUS [®] NET	EtherNet/IP	EtherCAT [™]	ETHERNET [™] POWERLINK
Number of outputs	16	16	16	16	16	16	16
	32	32	32	32	32	32	32
Output polarity	PNP	PNP	PNP	PNP	PNP	PNP	PNP
	NPN	NPN	NPN	NPN	NPN	NPN	
Communication connector	M12	M12	M12	M12	M12	M12	M12
	D-sub						

Communication connector examples



M12 communication connector (PROFIBUS DP)



D-sub communication connector (PROFIBUS DP)

SY3000/5000/7000 Series

Valve piping direction variations

■ Piping is possible from 3 directions.

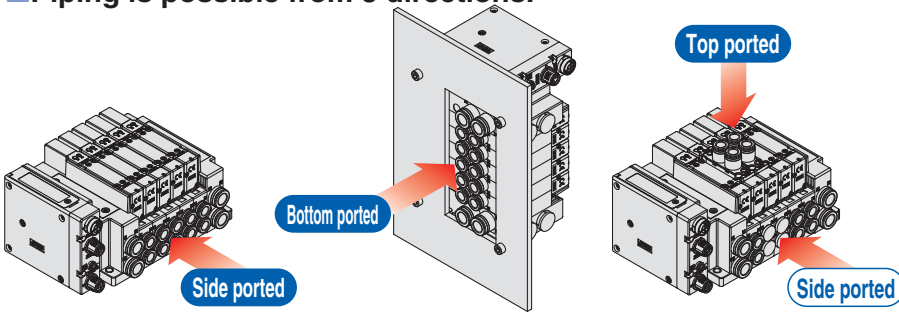

Mixed mounting of top ported and side ported is possible.

Pressure switch

<Example of Use>

By mounting top ported valves on side ported and bottom ported type manifolds, it is possible to detect the output of the A/B port with a pressure switch.

Up to 24 valve stations can be freely connected.

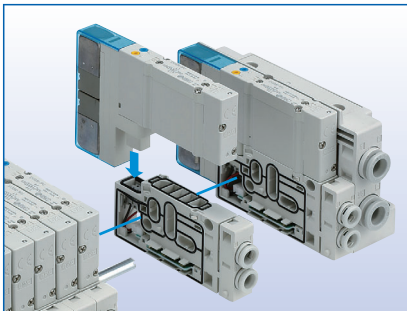

■ It is possible to connect only the number of valves required, from 1 to 24 stations, to suit the application.
(Maximum number of solenoids connected: 32)

Mixed valve sizes manifold

■ Valves with different sizes, SY3000 and SY5000 or SY5000 and SY7000, can be mounted on the same manifold.

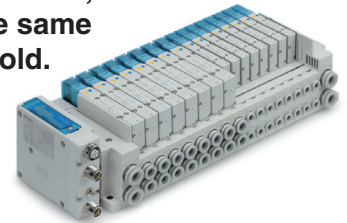











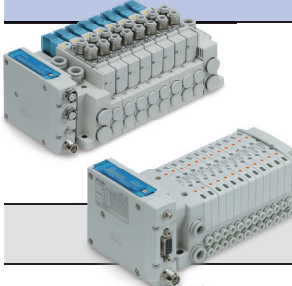

Series S0700

7 mm width valves can be connected.



■ It is possible to connect only the number of 7 mm width valves required, from 1 to 24 stations.
(Maximum number of solenoids connected: 32)

● Applicable Valve Series

Series	Flow rate characteristics (4/2→5/3)			Maximum number of solenoids	Power consumption [W]	Enclosure	Standards
	C [dm ³ /(s·bar)]	b	Q [l/min] (ANR) <small>Note 2)</small>				
	SY3000	1.6	0.19	381	32	0.35 (Standard) 0.1 (With power-saving circuit) [Inrush 0.4, Holding 0.1]	 
	SY5000	3.6	0.17	848			
	SY7000	5.9	0.20	1413			
	S0700	0.37	0.39	100	32	0.35	 
	SV1000	1.1	0.35	289	32	0.6	 
	SV2000	2.4	0.18	568			
	SV3000	4.3	0.21	1036			
	VQC1000	1.0	0.30	254	24	0.4 (Standard) 0.95 (Standard) 0.4 (Low-wattage type)	 
	VQC2000	3.2	0.30	814			
	VQC4000	7.3	0.38	1958			
	VQC5000	17	0.31	4350			

Note 1) For units with D-sub communication connector, it is IP40.

Note 2) These values have been calculated according to ISO6358 and indicate the flow rate under standard conditions with an inlet pressure of 0.6 MPa (relative pressure) and a pressure drop of 0.1 MPa.

Note 3) SY series is UL-compliant except for; with residual pressure release valve, vacuum release valve with restrictor and specials others than X90 and X320.

Applicable Product Selection by Type

IP67/65 specification models

		Type 1 Output type for solenoid valves		Type 2 Gateway type	Type 3 Integrated input-output type		
	Number of valve outputs	32		 EX500	 EX600 EX245 EX250		
		16					
	Number of inputs	16		 EX260 EX124			
		32					
Applicable protocols	EtherNet/IP™	●		●	●		●
	PROFINET	●		●		●	
	Modbus®TCP	◆					◆
	Ethernet POWERLINK	●			◆		
	EtherCAT	●			●		
	CC-Link IE Field				◆		◆
	PROFIBUS DP	●		●	●		●
	DeviceNet™		●	●			●
	CC-Link	●	●		●		●
	AS-Interface	◆					●
	CANopen	◆					●
	CompoNet™		◆				
	INTERBUS					◆	
IO-Link	◆						
Series		EX260	EX124	EX500	EX600	EX245	EX250
Applicable valve series	SY (Plug-in connector connecting base: 10/11/12 type)	3000	●	●	●	●	●
		5000	●	●	●	●	●
		7000	●	●	●	●	●
	S0700 (Stacking base)	0700	●	●	●	●	●
		1000	●	●	●	●	●
		2000	●	●	●	●	●
		4000	●	●	●	●	●
	SV	3000	●	●	●	●	●
		4000	●	●	●	●	●
		5000	●	●	●	●	●
	VQC	1000	●	●	●	●	●
		2000	●	●	●	●	●
		4000	●	●	●	●	●
5000		●	●	●	●	●	
VQ	1000	●	●	●	●	●	
	2000	●	●	●	●	●	
	4000	●	●	●	●	●	
	5000	●	●	●	●	●	

●: Standard product ◆: Made to order*1

*1 Please contact SMC for details about the Made to Orders.

IP20 specification models

			Type 1 Output type for solenoid valves			Type 2 Gateway type	Type 3 Integrated input-output type					
	Number of valve outputs	32										
		16										
	Number of inputs	16										
		32										
Applicable protocols			EtherNet/IP™			◆						
			PROFINET						◆			
			Modbus®TCP									
			Ethernet POWERLINK									
			EtherCAT						◆			
			CC-Link IE Field									
			PROFIBUS DP			●			●			
			DeviceNet™			●			●			
			CC-Link			●			●			
			AS-Interface			●			●			
			CANopen			●			●			
			CompoNet™			●			●			
			INTERBUS			●			●			
IO-Link			●			●						
Series			EX120	EX121	EX122	EX140	EX180	EX510	—			
Applicable valve series	SY	(Plug-in connector connecting base: 10/11/12 type)	3000	●								
			5000	●								
			7000	●								
	SJ	(Plug-in metal base: 50/51/52 type)	3000					●				
			5000					●				
			7000					●				
	S0700 (Bar stock)		2000					●				
			3000					●				
	SY	(Bar stock: 42SA type)	0700					●				
			3000					●				
			5000					●				
			7000					●				
	SV	(Stacking base: 45S6/43SA type)	3000	●				●				
			5000	●				●				
			7000	●				●				
			9000	●				●				
	VQ		1000	●				●				
			2000	●				●				
			3000	●				●				
			4000	●				●				
SQ		1000			●		●					
		2000			●		●					
		3000			●		●					
SZ		1000			●		●					
		2000			●		●					
		3000			●		●					
VQZ		1000					●					
		2000					●					
		3000					●					
SYJ		1000					●					
		2000					●					
		3000					●					
	5000					●						
	7000					●						

●: Standard product ◆: Made to order*1

*1 Please contact SMC for details about the Made to Orders.

INDEX

Fieldbus System (Output device for driving 5-port solenoid valves) **EX260 Series**

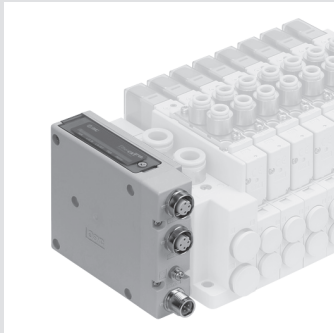

How to Order SI Units	p. 1
Specifications	p. 2
Dimensions	p. 3
Parts Description	p. 3
LED Indicator	p. 4

Accessories

① Communication Cable	p. 5
② Field-wireable Communication Connector	p. 7
③ Power Supply Cable (For SI unit)	p. 8
④ Power Supply Cable (For SI unit/For power block)	p. 9
⑤ Seal Cap (10 pcs.)	p. 9
⑥ Output Block	p. 10
⑦ Power Block	p. 10
⑧ Connector for Output Block Wiring	p. 11
⑨ End Plate	p. 11
⑩ Bracket Plate/DIN Rail Mounting Bracket	p. 11

Made to Order

① IO-Link compatible	p. 12
② EtherNet/IP™ Web server function compatible	p. 12
Communication Cable	p. 13
Power Supply Cable	p. 17

Specific Product Precautions	p. 19
------------------------------------	-------

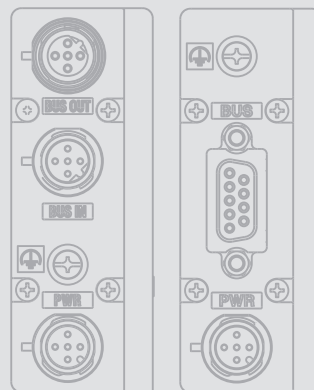
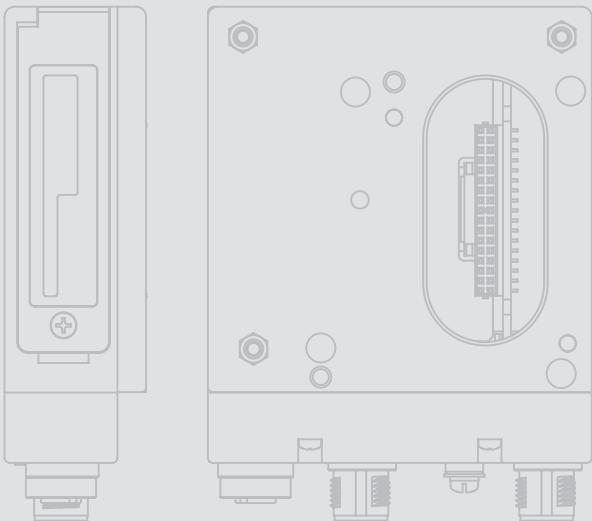

SI Unit Integrated-type/ For Output Series EX260

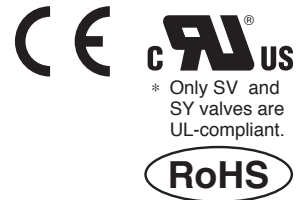

Compact design	Compact design for space saving
Number of outputs	Each 32/16 digital output type available in the series
Output polarity	Each negative common (PNP) / positive common (NPN) type available in the series (Only negative common (PNP) is available for units compatible with Ethernet POWERLINK.)
Enclosure	IP67 (For units with D-sub connector, and when connected with S0700 manifolds, it is IP40.)
Internal terminating resistor	ON/OFF switching is possible with an internal terminating resistor for communication. (Only for units compatible with M12 PROFIBUS DP, CC-Link communication connectors)

SY3000/5000/7000

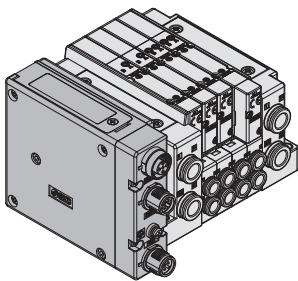

VQC1000/2000/4000/5000

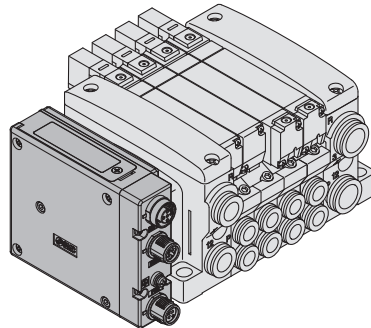

S0700

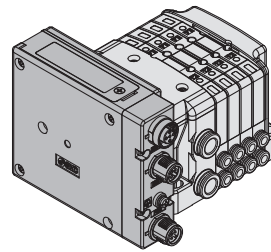

SV1000/2000/3000

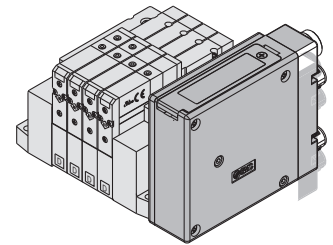

How to Order SI Units

EX260 - S PR1

Communication protocol

Symbol	Protocol	Number of outputs	SI unit output polarity	Communication connector	Manifold symbol	
DN1	DeviceNet™	32	Source/PNP (Negative common)	M12	QAN	
DN2			Sink/NPN (Positive common)		QA	
DN3		16	Source/PNP (Negative common)		QBN	
DN4			Sink/NPN (Positive common)		QB	
PR1	PROFIBUS DP	32	Source/PNP (Negative common)	M12	NAN	
PR2			Sink/NPN (Positive common)		NA	
PR3		16	Source/PNP (Negative common)		NBN	
PR4			Sink/NPN (Positive common)		NB	
PR5		32	Source/PNP (Negative common)		D-sub ^{Note)}	NCN
PR6			Sink/NPN (Positive common)			NC
PR7		16	Source/PNP (Negative common)			NDN
PR8			Sink/NPN (Positive common)			ND
MJ1	CC-Link	32	Source/PNP (Negative common)	M12		VAN
MJ2			Sink/NPN (Positive common)			VA
MJ3		16	Source/PNP (Negative common)			VBN
MJ4			Sink/NPN (Positive common)			VB
EC1	EtherCAT	32	Source/PNP (Negative common)	M12	DAN	
EC2			Sink/NPN (Positive common)		DA	
EC3		16	Source/PNP (Negative common)		DBN	
EC4			Sink/NPN (Positive common)		DB	
PN1	PROFINET	32	Source/PNP (Negative common)	M12	FAN	
PN2			Sink/NPN (Positive common)		FA	
PN3		16	Source/PNP (Negative common)		FBN	
PN4			Sink/NPN (Positive common)		FB	
EN1	EtherNet/IP™	32	Source/PNP (Negative common)	M12	EAN	
EN2			Sink/NPN (Positive common)		EA	
EN3		16	Source/PNP (Negative common)		EBN	
EN4			Sink/NPN (Positive common)		EB	
PL1	Ethernet POWERLINK	32	Source/PNP (Negative common)	M12	GAN	
PL3		16			GBN	

Note) Enclosure is IP40 when the communication connector is D-sub.



Made to Order
→ p. 12

IO-Link compatible
EtherNet/IP™ Web server function compatible

Specifications

All SI Units Common Specifications

Power supply for control	Power supply voltage	21.6 to 26.4 VDC*1
	Internal current consumption	100 mA or less
Power supply for output	Power supply voltage	22.8 to 26.4 VDC
Environmental resistance	Enclosure	IP67*2
	Operating temperature range	-10 to +50 °C
	Operating humidity range	35 to 85 %RH (No condensation)
	Withstand voltage	500 VAC for 1 minute between terminals and housing
	Insulation resistance	10 MΩ or more (500 VDC measured via megohmmeter) between terminals and housing
Standards	CE marking, UL (CSA) compliant	
Weight	200 g	
Accessories	Mounting screw	2 pcs.
	Seal cap (for M12 connector socket)	EX9-AWTS (1 pc.)*3

*1 For EX260-SDN□, the power supply voltage will be 11 to 25 VDC to serve as the power supply for communication.

*2 IP40 applies to EX260-SPR5/6/7/8.

*3 Not provided for EX260-SPR5/6/7/8

Model	EX260-SPR1/3	EX260-SPR2/4	EX260-SPR5/7	EX260-SPR6/8	EX260-SDN1/3	EX260-SDN2/4	EX260-SMJ1/3	EX260-SMJ2/4	
Applicable system	Protocol				PROFIBUS DP		DeviceNet™		CC-Link
	Version*1				DP-V0		Volume1 (Edition 3.5) Volume3 (Edition 1.5)		Ver.1.10
	Configuration file*3				GSD file		EDS file		CSP+ file
I/O occupation area (Inputs/Outputs)	SPR1: 0/32 SPR3: 0/16	SPR2: 0/32 SPR4: 0/16	SPR5: 0/32 SPR7: 0/16	SPR6: 0/32 SPR8: 0/16	SDN1: 0/32 SDN3: 0/16	SDN2: 0/32 SDN4: 0/16	SMJ1: 32/32 SMJ3: 32/32 (1 station, remote I/O stations)	SMJ2: 32/32 SMJ4: 32/32 (1 station, remote I/O stations)	
Applicable function	—				QuickConnect™		—		
Communication speed	9.6 k/19.2 k/45.45 k/93.75 k/ 187.5 k/500 k/1.5 M/3 M/6 M/12 Mbps				125 k/250 k/500 kbps		156 k/625 k/ 2.5 M/5 M/10 Mbps		
Communication connector specification	M12			D-sub		M12			
Terminating resistor switch	Built-in			None			Built-in		
Output	Output type	Source/PNP (Negative common)	Sink/NPN (Positive common)	Source/PNP (Negative common)	Sink/NPN (Positive common)	Source/PNP (Negative common)	Sink/NPN (Positive common)	Source/PNP (Negative common)	Sink/NPN (Positive common)
	Number of outputs	SPR1: 32 points SPR3: 16 points	SPR2: 32 points SPR4: 16 points	SPR5: 32 points SPR7: 16 points	SPR6: 32 points SPR8: 16 points	SDN1: 32 points SDN3: 16 points	SDN2: 32 points SDN4: 16 points	SMJ1: 32 points SMJ3: 16 points	SMJ2: 32 points SMJ4: 16 points
	Load	Solenoid valve with surge voltage suppressor 24 VDC, 1.5 W or less (SMC)							
	Supplied voltage	24 VDC							
	Supplied current	SPR1: Max. 2.0 A SPR3: Max. 1.0 A	SPR2: Max. 2.0 A SPR4: Max. 1.0 A	SPR5: Max. 2.0 A SPR7: Max. 1.0 A	SPR6: Max. 2.0 A SPR8: Max. 1.0 A	SDN1: Max. 2.0 A SDN3: Max. 1.0 A	SDN2: Max. 2.0 A SDN4: Max. 1.0 A	SMJ1: Max. 2.0 A SMJ3: Max. 1.0 A	SMJ2: Max. 2.0 A SMJ4: Max. 1.0 A

Model	EX260-SEC1/3	EX260-SEC2/4	EX260-SPN1/3	EX260-SPN2/4	EX260-SEN1/3	EX260-SEN2/4	EX260-SPL1	EX260-SPL3	
Applicable system	Protocol		EtherCAT*2		PROFINET*2		EtherNet/IP™*2		Ethernet POWERLINK*2
	Version*1		Conformance Test Record V.1.1		PROFINET Specification Version 2.2		Volume1 (Edition 3.17) Volume2 (Edition 1.18)		EPSS DS 301 Version 1.2.0
	Configuration file*3		XML file		GSD file		EDS file		XDD file
I/O occupation area (Inputs/Outputs)	SEC1: 0/32 SEC3: 0/16	SEC2: 0/32 SEC4: 0/16	SPN1: 0/32 SPN3: 0/16	SPN2: 0/32 SPN4: 0/16	SEN1: 16/32 SEN3: 16/16	SEN2: 16/32 SEN4: 16/16	16/32	16/16	
Applicable function	—		FSU, MRP		QuickConnect™, DLR		—		
Communication speed	100 Mbps*2				10 M/100 Mbps*2		100 Mbps*2		
Communication connector specification	M12								
Terminating resistor switch	None (Not required)								
Output	Output type	Source/PNP (Negative common)	Sink/NPN (Positive common)	Source/PNP (Negative common)	Sink/NPN (Positive common)	Source/PNP (Negative common)	Sink/NPN (Positive common)	Source/PNP (Negative common)	
	Number of outputs	SEC1: 32 points SEC3: 16 points	SEC2: 32 points SEC4: 16 points	SPN1: 32 points SPN3: 16 points	SPN2: 32 points SPN4: 16 points	SEN1: 32 points SEN3: 16 points	SEN2: 32 points SEN4: 16 points	32 16	
	Load	Solenoid valve with surge voltage suppressor 24 VDC, 1.5 W or less (SMC)		Solenoid valve with surge voltage suppressor 24 VDC, 1.0 W or less (SMC)		Solenoid valve with surge voltage suppressor 24 VDC, 1.5 W or less (SMC)			
	Supplied voltage	24 VDC							
	Supplied current	SEC1: Max. 2.0 A SEC3: Max. 1.0 A	SEC2: Max. 2.0 A SEC4: Max. 1.0 A	SPN1: Max. 2.0 A SPN3: Max. 1.0 A	SPN2: Max. 2.0 A SPN4: Max. 1.0 A	SEN1: Max. 2.0 A SEN3: Max. 1.0 A	SEN2: Max. 2.0 A SEN4: Max. 1.0 A	Max. 2 A	Max. 1 A

*1 Please note that the version is subject to change.

*2 Use a CAT5 or higher transmission cable for EtherCAT, PROFINET, Ethernet/IP™, and Ethernet POWERLINK.

*3 The setting file can be downloaded from the SMC website, <http://www.smc.eu>

EX260 Series

Dimensions

M12 communication connector type

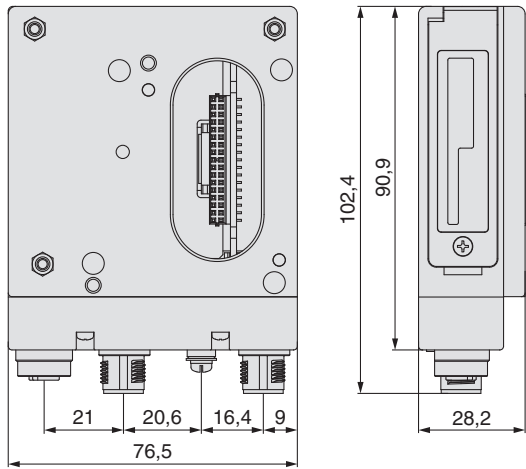

D-sub communication connector type (EX260-SPR5/6/7/8)

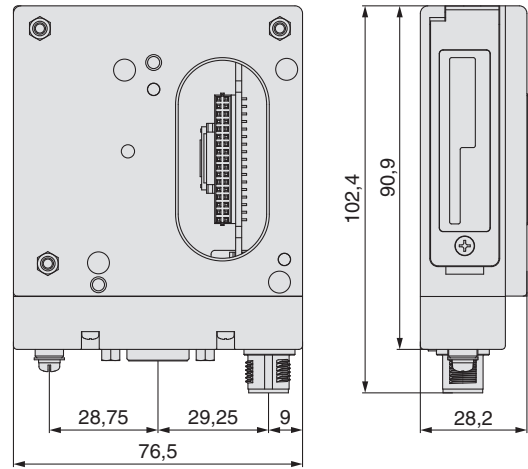

Parts Description

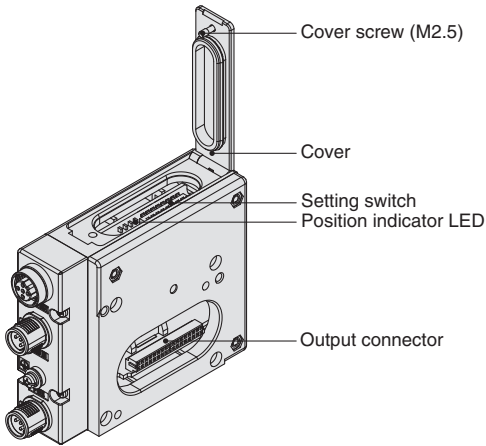

* The setting switch varies depending on the model. Refer to the operation manual for details. Please download it via the SMC website, <http://www.smc.eu>

<Connector>

M12 communication connector type

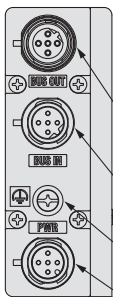

Part no.	EX260-SPR1/-SPR2 -SPR3/-SPR4	EX260-SDN□	EX260-SMJ□	EX260-SEC□ EX260-SPN□ EX260-SEN□ EX260-SPL□
Communication protocol	PROFIBUS DP	DeviceNet™	CC-Link	EtherCAT PROFINET EtherNet/IP™ Ethernet POWERLINK
Communication connector (M12) BUS OUT	5 pins, socket, B code (SPEEDCON)	5 pins, socket, A code (SPEEDCON)	5 pins, socket, A code*1 (SPEEDCON)	4 pins, socket, D code (SPEEDCON)
Communication connector (M12) BUS IN	5 pins, plug, B code (SPEEDCON)	5 pins, plug, A code (SPEEDCON)	4 pins, plug, A code (SPEEDCON)	4 pins, socket, D code (SPEEDCON)
Ground terminal	M3			
Power connector (M12)	5 pins, plug, A code (SPEEDCON)	4 pins, plug, A code (SPEEDCON)	5 pins, plug, B code (SPEEDCON)	5 pins*2, 4 pins*3, plug, A code (SPEEDCON)

D-sub communication connector type

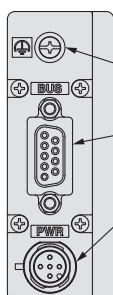

Part no.	EX260-SPR5/-SPR6/-SPR7/-SPR8
Communication protocol	PROFIBUS DP
Ground terminal	M3
Communication connector (D-sub) BUS IN/OUT	9 pins, socket
Power connector (M12)	5 pins, plug, A code

*1 Recommended mating M12 4-pin plug, part no. PCA-1567717.

*2 For EtherCAT, PROFINET and Ethernet POWERLINK

*3 For EtherNet/IP™

LED Indicator

EX260-SDN

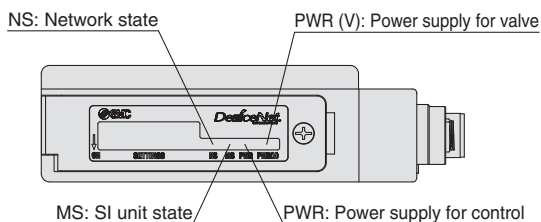

EX260-SEC

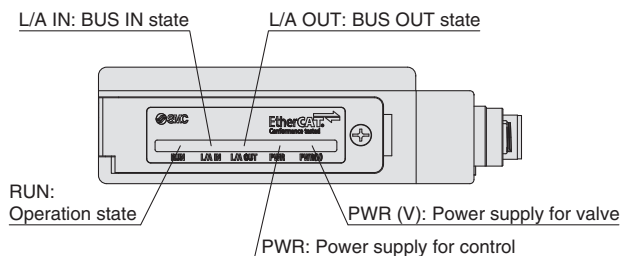

EX260-SEN

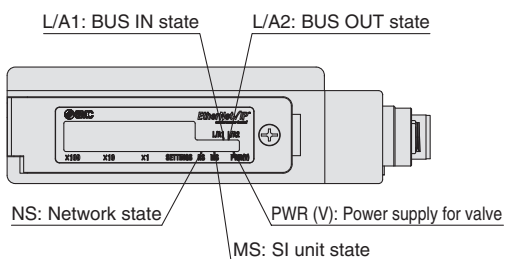

EX260-SMJ

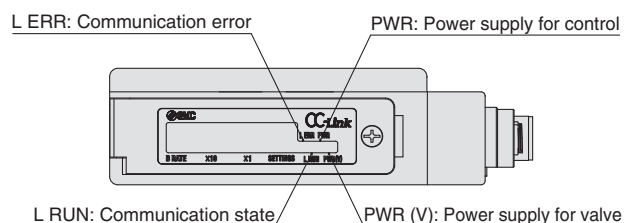

EX260-SPN

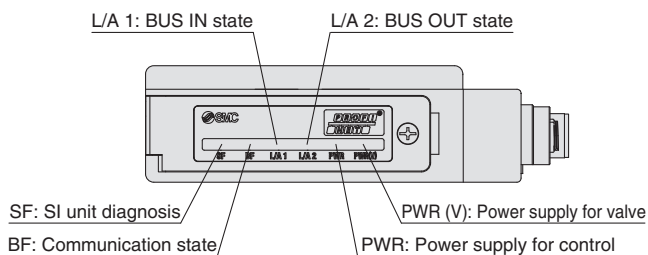

EX260-SPR

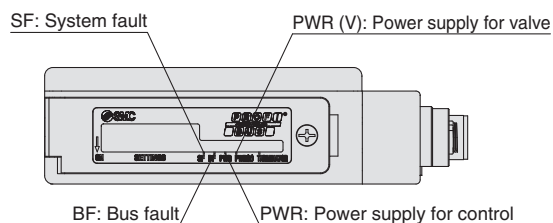

EX260-SPL

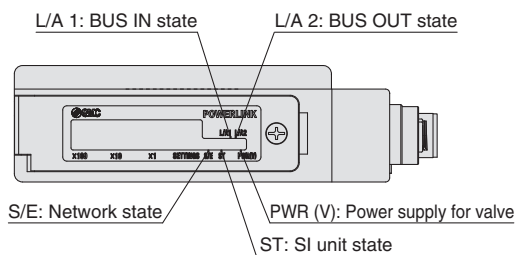

EX260 Series Accessories

① Communication Cable

For CC-Link

PCA-1567720
(Socket)

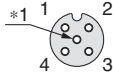

Socket connector pin assignment
A-coded (Normal key)
*1 Number of holes: 5,
Total number of pins: 4

PCA-1567717
(Plug)



Plug connector pin arrangement
A-coded (Normal key)

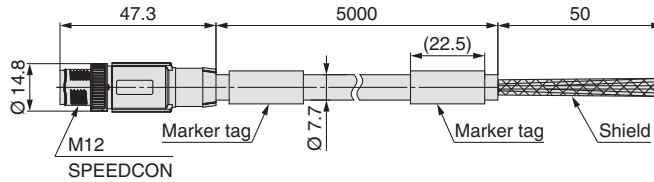
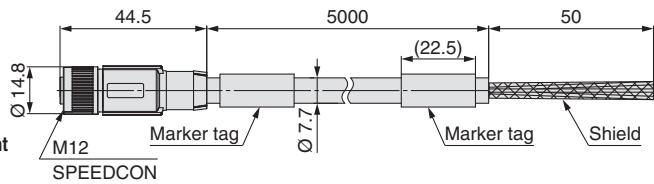

Made to Order

Cable length	10000 mm	p. 15
--------------	----------	-------

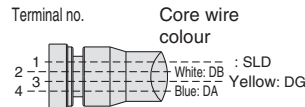

Connections

Item	Specifications
Cable O.D.	Ø 7.7 mm
Conductor nominal cross section	0.5 mm ² /AWG20
Wire O.D. (Including insulator)	2.55 mm
Min. bending radius (Fixed)	77 mm

For DeviceNet™

PCA-1557633
(Socket)

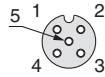

Socket connector pin assignment
A-coded (Normal key)

PCA-1557646
(Plug)

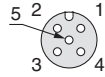

Plug connector pin arrangement
A-coded (Normal key)

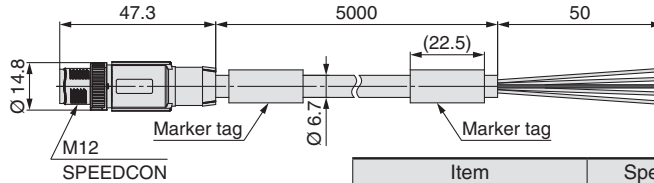
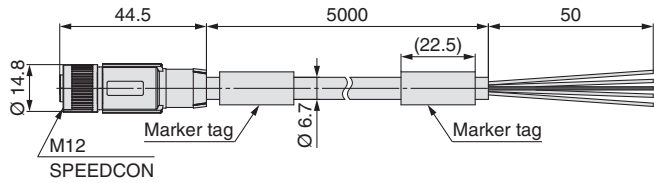

Made to Order

Cable length	10000 mm	p. 15
--------------	----------	-------

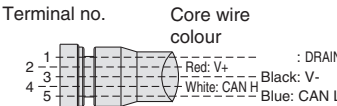

Connections

Item	Specifications
Cable O.D.	Ø 6.7 mm
Conductor nominal cross section	Power pair 0.33 mm ² /AWG22
	Data pair 0.2 mm ² /AWG24
Wire O.D. (Including insulator)	Power pair 1.4 mm
	Data pair 2.05 mm
Min. bending radius (Fixed)	67 mm

For PROFIBUS DP

PCA-1557688
(Socket)

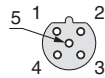

Socket connector pin assignment
B-coded (Reverse key)

PCA-1557691
(Plug)

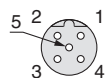

Plug connector pin arrangement
B-coded (Reverse key)

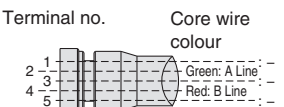
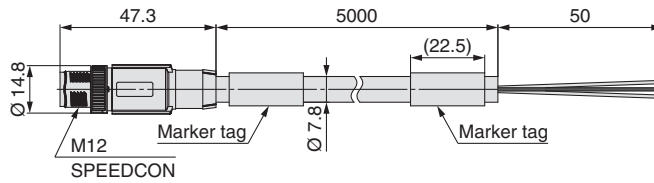
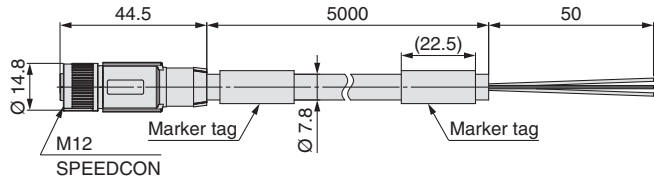

Shield line is connected to the knurl.
Connections

Item	Specifications
Cable O.D.	Ø 7.8 mm
Conductor nominal cross section	0.34 mm ² /AWG22
Wire O.D. (Including insulator)	2.55 mm
Min. bending radius (Fixed)	78 mm

① Communication Cable

For EtherCAT For PROFINET For EtherNet/IP™ For Ethernet POWERLINK

EX9-AC **020** EN-PSRJ (Plug/RJ-45 connector)

● Cable length (L)

010	1000 mm
020	2000 mm
030	3000 mm
050	5000 mm
100	10000 mm

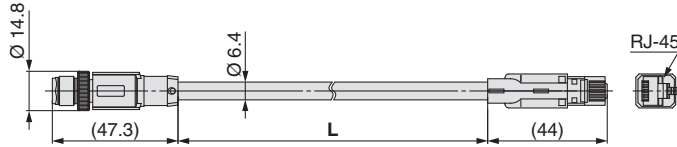

Plug connector pin arrangement D-coded

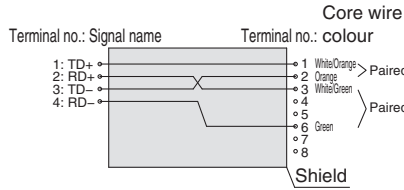

Connections (Straight cable)

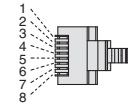

Plug connector pin arrangement

Item	Specifications
Cable O.D.	Ø 6.4 mm
Conductor nominal cross section	0.14 mm ² /AWG26
Wire O.D. (Including insulator)	0.98 mm
Min. bending radius (Fixed)	26 mm

PCA-1446566 (Plug)



Plug connector pin arrangement D-coded

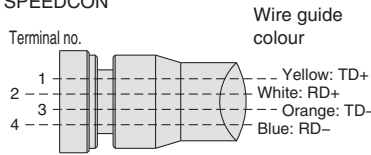
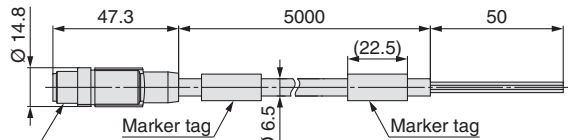

Connections

Item	Specifications
Cable O.D.	Ø 6.5 mm
Conductor nominal cross section	0.34 mm ² /AWG22
Wire O.D. (Including insulator)	1.5 mm
Min. bending radius (Fixed)	19.5 mm



Made to Order

With angle connector on both sides, Change in the cable length p. 16

EX260 Series

② Field-wireable Communication Connector

Plug

For CC-Link For DeviceNet™
PCA-1557617 PCA-1557659

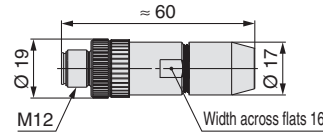

For PROFIBUS DP
PCA-1557701

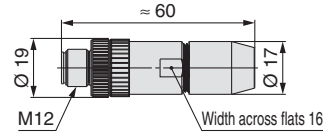

Applicable Cable

Item	Specifications
Cable O.D.	4.0 to 8.0 mm
Wire gauge (Stranded wire cross section)	0.14 to 0.5 mm ² AWG26 to 20

For EtherCAT For PROFINET For EtherNet/IP™ For Ethernet POWERLINK
PCA-1446553

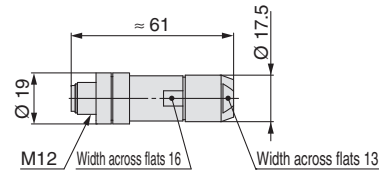
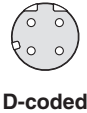

Applicable Cable

Item	Specifications
Cable O.D.	4.0 to 8.0 mm
Wire gauge (Stranded wire cross section)	0.14 to 0.34 mm ² /AWG26 to 22

* The table above shows the specifications for the applicable cable. Adaptation for the connector may vary on account of the conductor construction of the electric wire.

Socket

For CC-Link For DeviceNet™
PCA-1557620 PCA-1557662

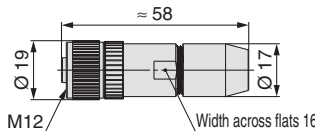

For PROFIBUS DP
PCA-1557714

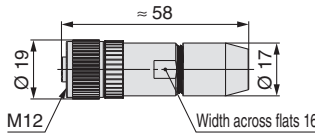

Applicable Cable

Item	Specifications
Cable O.D.	4.0 to 8.0 mm
Wire gauge (Stranded wire cross section)	0.14 to 0.5 mm ² AWG26 to 20

③ Power Supply Cable (For SI unit)

For PROFIBUS DP For DeviceNet™ For EtherCAT For PROFINET For EtherNet/IP™ For Ethernet POWERLINK

EX500-AP **050** - **S**

Cable length (L)

010	1000 mm
050	5000 mm

Connector specification

S	Straight
A	Angle

Straight connector type

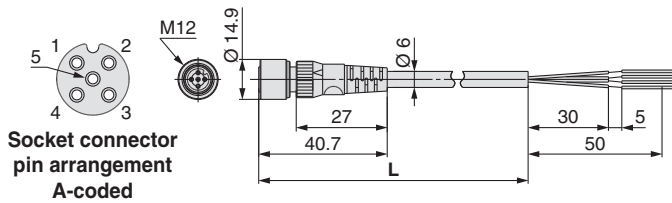

Item	Specifications
Cable O.D.	Ø 6 mm
Conductor nominal cross section	0.3 mm ² /AWG22
Wire O.D. (Including insulator)	1.5 mm
Min. bending radius (Fixed)	40 mm

Angle connector type

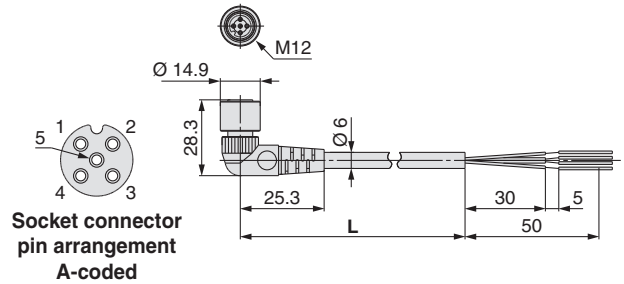

Item	Specifications
Cable O.D.	Ø 6 mm
Conductor nominal cross section	0.3 mm ² /AWG22
Wire O.D. (Including insulator)	1.5 mm
Min. bending radius (Fixed)	40 mm

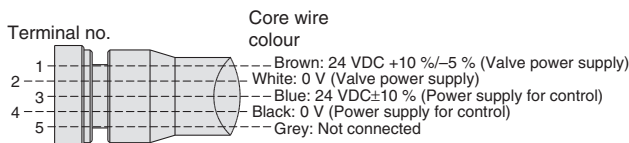

Connections (PROFIBUS DP/EtherCAT/PROFINET/Ethernet POWERLINK)

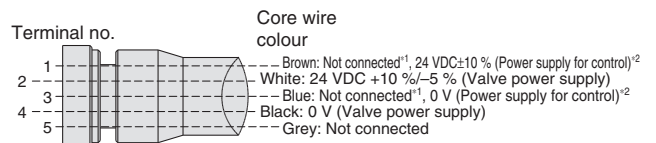

Connections (DeviceNet™, EtherNet/IP™) ^{*1} For DeviceNet™ ^{*2} For EtherNet/IP™



Made to Order

Cable length	10000 mm	p. 18
--------------	----------	--------------

PCA- **1401804**

Cable length (L)

1401804	1500 mm
1401805	3000 mm
1401806	5000 mm

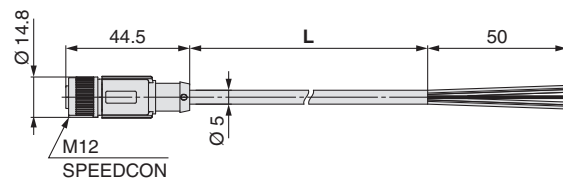
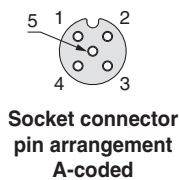

Item	Specifications
Cable O.D.	Ø 5 mm
Conductor nominal cross section	0.34 mm ² /AWG22
Wire O.D. (Including insulator)	1.27 mm
Min. bending radius (Fixed)	21.7 mm

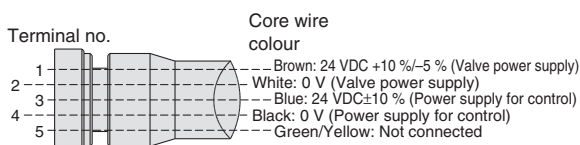

Connections (PROFIBUS DP/EtherCAT/PROFINET/Ethernet POWERLINK)

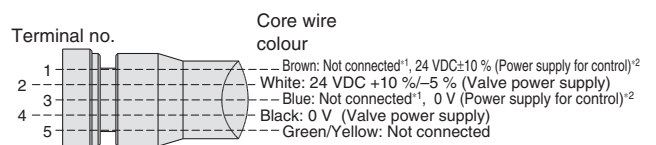

Connections (DeviceNet™, EtherNet/IP™) ^{*1} For DeviceNet™ ^{*2} For EtherNet/IP™

EX260 Series

④ Power Supply Cable (For SI unit/For power block)

Straight connector type

EX9-AC 050 -1

● Cable length (L)

010	1000 mm
030	3000 mm
050	5000 mm

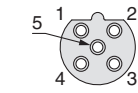

Socket connector pin arrangement B-coded

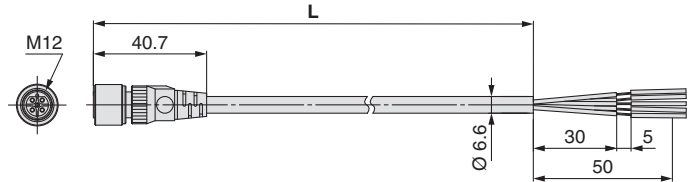

Item	Specifications
Cable O.D.	Ø 6.6 mm
Conductor nominal cross section	0.3 mm ² /AWG22
Wire O.D. (Including insulator)	1.65 mm
Min. bending radius (Fixed)	40 mm



Made to Order

Cable length	7000, 10000 mm	p. 17
--------------	----------------	-------

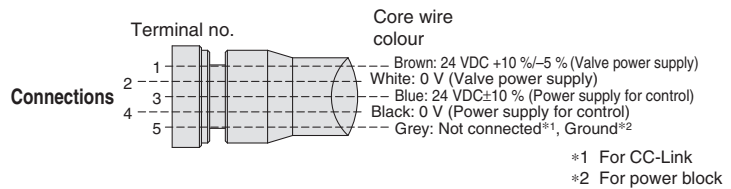

PCA-1401807

● Cable length (L)

1401807	1500 mm
1401808	3000 mm
1401809	5000 mm

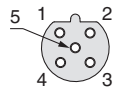

Socket connector pin arrangement B-coded

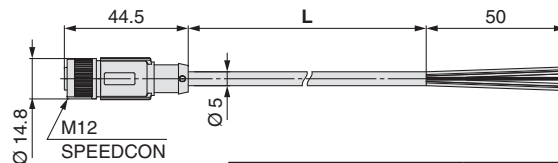

Item	Specifications
Cable O.D.	Ø 5 mm
Conductor nominal cross section	0.34 mm ² /AWG22
Wire O.D. (Including insulator)	1.27 mm
Min. bending radius (Fixed)	21.7 mm

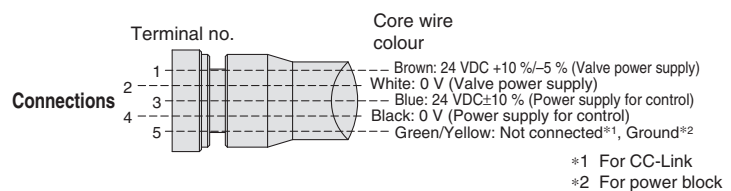

⑤ Seal Cap (10 pcs.)

Use this on ports that are not being used for communication connector (M12 connector socket).
Use of this seal cap maintains the integrity of the IP67 enclosure.

* Tighten the seal cap with the prescribed tightening torque. (For M12: 0.1 N·m)

EX9-AW TS

● Connector specification

TS	For M12 connector socket (10 pcs.)
----	------------------------------------

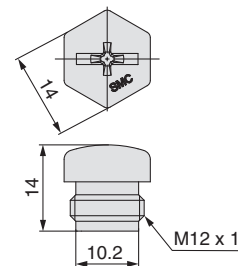

For M12 connector socket

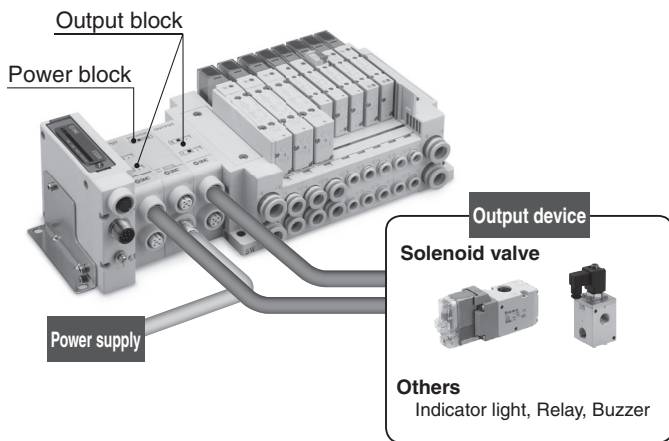

- Output devices other than valve manifold can be operated.
- By using the power block and output block for high watt load, operation up to 0.5 A/point can be performed.
- Possible to mount the output block and power block additionally between the SI unit and the valve (The surplus I/O points are used).
- 2 point outputs per output block (M12 connector)

You are requested to connect it to an SI unit and a valve manifold. For detailed specifications, refer to the operation manual that can be downloaded from SMC website, <http://www.smc.eu>

6 Output Block

EX9-OE T 1

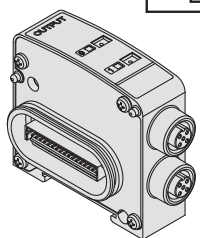

Output specification

1	Source/PNP (Negative common)
2	Sink/NPN (Positive common)

Power supply type

T	Internal power supply method (for low-wattage load)
P	Integrated power supply method (for high-wattage load) *1

*1 Required to connect with a power block

Dimensions/Parts Description

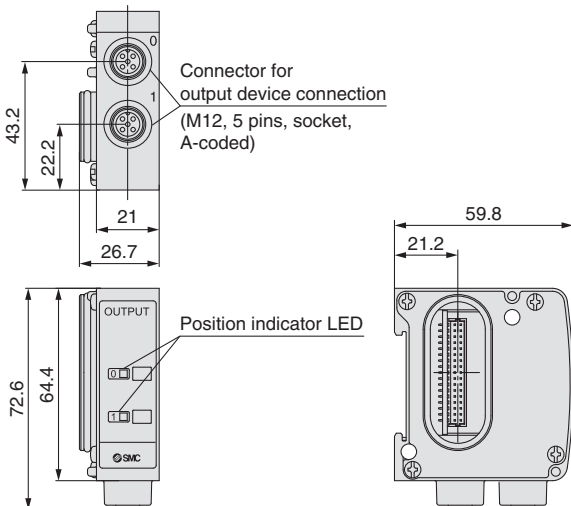

Specifications

Model	EX9-OET1	EX9-OET2	EX9-OEP1	EX9-OEP2	
Internal current consumption	40 mA or less				
Output	Output type	Source/PNP (Negative common)	Sink/NPN (Positive common)	Source/PNP (Negative common) / Sink/NPN (Positive common)	
	Number of outputs	2 outputs			
	Power supply method	Internal power supply method		Integrated power supply method (Power block: supplied from EX9-PE1)	
	Output device supply voltage	24 VDC			
	Output device supply current	Max. 42 mA/point (1.0 W/point)		Max. 0.5 A/point (12 W/point)	
Environmental resistance	Enclosure	IP67			
	Operating temperature range	-10 to 50 °C			
	Operating humidity range	35 to 85 %RH (No condensation)			
Standards	CE marking, UL (CSA), RoHS compliant				
Weight	120 g				

7 Power Block

EX9-PE1

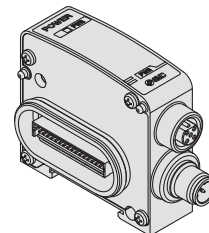

Dimensions/Parts Description

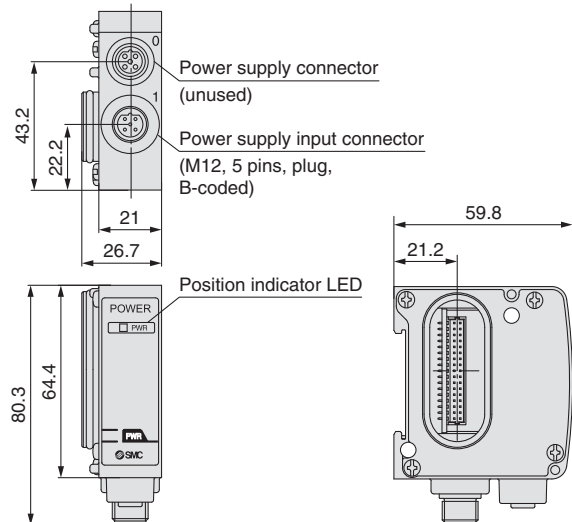

Specifications

Model	EX9-PE1	
Connection block	Output block for high wattage load	
Connection block stations	Output block: Max. 8 stations	
Power supply for output and internal control	Power supply voltage	22.8 to 26.4 VDC
	Internal current consumption	20 mA or less
Supply current	Max. 3.1 A*1	
Environmental resistance	Enclosure	IP67
	Operating temperature range	-10 to 50 °C
	Operating humidity range	35 to 85 %RH (No condensation)
Standards	CE marking, UL (CSA), RoHS compliant	
Weight	120 g	
Enclosed parts	Seal cap (for M12 connector) 1 pc.	

*1 When using with 3.0 to 3.1 A, the ambient temperature should not exceed 40°C, and do not bundle the cable.

EX260 Series

⑧ Connector for Output Block Wiring

Field-wireable connector for connecting an output device to an output block

PCA-1557743

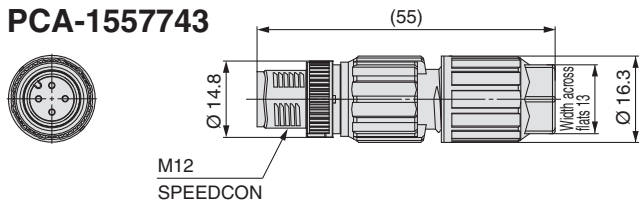

A-coded

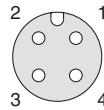

Plug pin arrangement

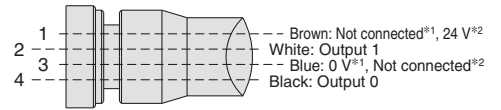

Connections

- *1 When used for EX9-OE□1
- *2 When used for EX9-OE□2

Applicable Cable

Item	Specifications
Cable O.D.	3.5 to 6.0 mm
Wire gauge (Stranded wire cross section)	0.14 to 0.34 mm ² /AWG26 to 22
Core wire diameter (Including insulating material)	0.7 to 1.3 mm

PCA-1557756

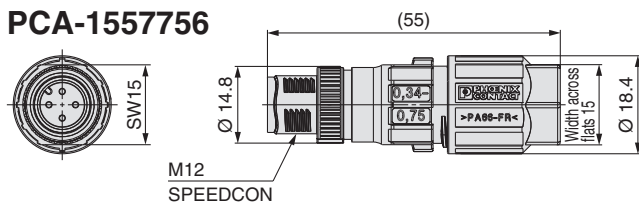

A-coded

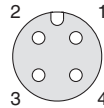

Plug pin arrangement

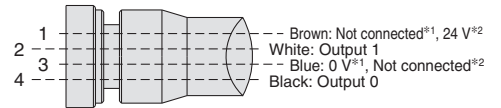

Connections

- *1 When used for EX9-OE□1
- *2 When used for EX9-OE□2

Applicable Cable

Item	Specifications
Cable O.D.	4.0 to 8.0 mm
Wire gauge (Stranded wire cross section)	0.34 to 0.75 mm ² /AWG22 to 18
Core wire diameter (Including insulating material)	1.3 to 2.5 mm

Refer to page 9 for the power supply cable for power block.

⑨ End Plate

Use when an output block is not being used and a valve manifold is not connected.

EX9-EA03

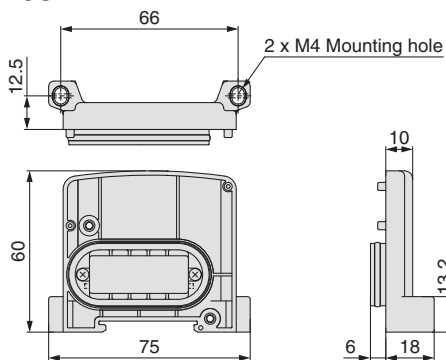

<Example of use>

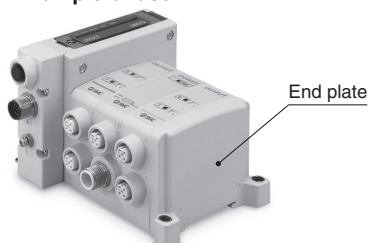

⑩ Bracket Plate/DIN Rail Mounting Bracket

A reinforcing brace used to mount an output block or power block onto an SI unit
To prevent connection failure between products due to deflection, use this bracket plate whenever an output block or power block is mounted.

EX9-BP1

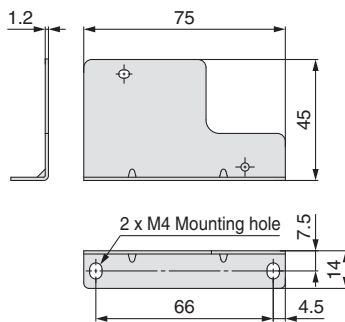

EX9-BD1

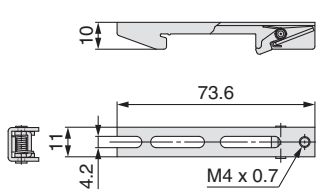

Accessory

Description	Qty.
Domed cap nut (M4)	1
Round head combination screw (M4 x 8)	1
Round head combination screw (M4 x 10)	1

Accessory

Description	Qty.
Hexagon socket head cap screw (M3 x 35)	2

<Example of use>

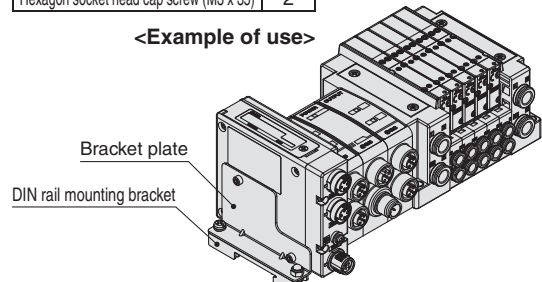

EX260 Series Made to Order

Please contact SMC for detailed specifications and lead times.



SI Unit

① IO-Link compatible

EX260-SIL1-X207

IO-Link port class

X207	IO-Link port class A, supplied from another connector
X210	IO-Link port class B

Output specification

1	32 outputs, PNP (Negative common)/Source
---	--

Communication protocol

IL	IO-Link
----	---------

- Send and receive ON/OFF signals + unit information/status
- Supports data update cycles of 1 ms or less
- IO-Link master and SI unit can be connected with one cable (Port class B compliant: X210 specifications)
- Uses 4-wire or 5-wire unshielded cables

EX260-SIL1-X207 (The X210 is not provided with a power supply connector.)

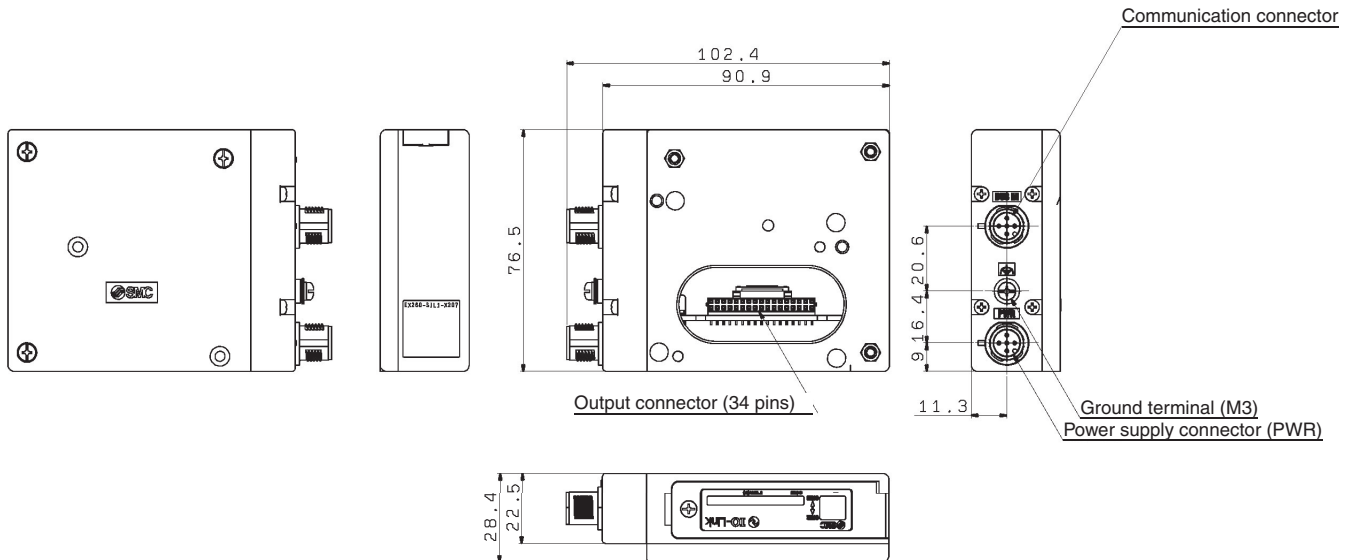

② EtherNet/IP™ Web server function compatible

EX260-SEN1-X194

- Web server compatible: Can conduct a valve operation test (ON/OFF), check communication state, set QuickConnect™, etc.
- Applicable to the power supply taken from Rockwell Automation's safe output module with pulse test function
- Compliant with QuickConnect™ class A specifications
- The gateway address is set to 192.168.□.001 when the IP address is set by the rotary switch.
- Dimensions are the same as those of the standard type.

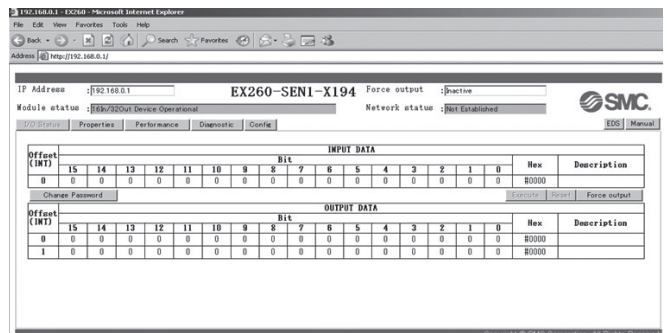

Web server screen (Example)

EX260 Series

Communication Cable

① With connector on both sides (Socket/Plug)

For CC-Link For DeviceNet™

EX9-AC 005 MJ -SSPS-X19

• Applicable protocol

MJ	CC-Link
DN	DeviceNet™

• Cable length (L)

005	500 mm
010	1000 mm
020	2000 mm
030	3000 mm
050	5000 mm
100	10000 mm

For CC-Link

Dimensions

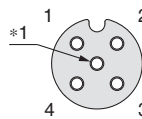
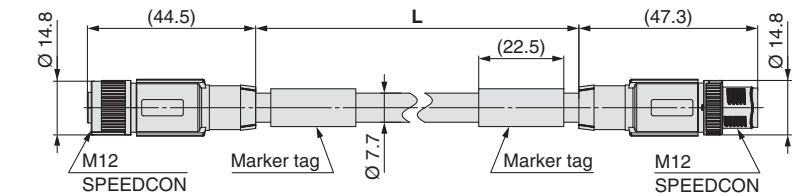

Socket connector pin arrangement
A-coded (Normal key)

*1 Number of holes: 5,
Total number of pins: 4

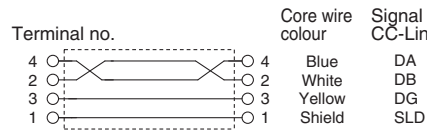

Connections

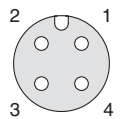

Plug connector pin arrangement
A-coded (Normal key)

Item	Specifications
Cable O.D.	Ø 7.7 mm
Conductor nominal cross section	0.43 mm ² /AWG20
Wire O.D. (Including insulator)	2.55 mm
Min. bending radius (Fixed)	77 mm

For DeviceNet™

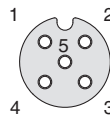

Socket connector pin arrangement
A-coded (Normal key)

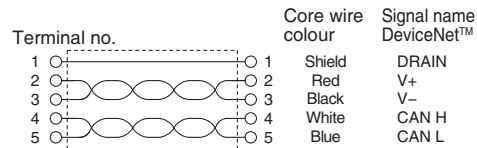

Connections

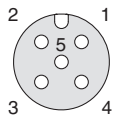

Plug connector pin arrangement
A-coded (Normal key)

Item	Specifications	
Cable O.D.	Ø 6.7 mm	
Conductor nominal cross section	Power pair	0.32 mm ² /AWG22
	Data pair	0.2 mm ² /AWG24
Wire O.D. (Including insulator)	Power pair	1.4 mm
	Data pair	2.05 mm
Min. bending radius (Fixed)	67 mm	

Communication Cable

② With angle connector on both sides (Socket/Plug)

For CC-Link For DeviceNet™
EX9-AC 005 MJ -SAPA-X19

• Applicable protocol

MJ	CC-Link
DN	DeviceNet™

• Cable length (L)

005	500 mm
010	1000 mm
020	2000 mm
030	3000 mm
050	5000 mm
100	10000 mm

Dimensions

For CC-Link

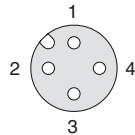
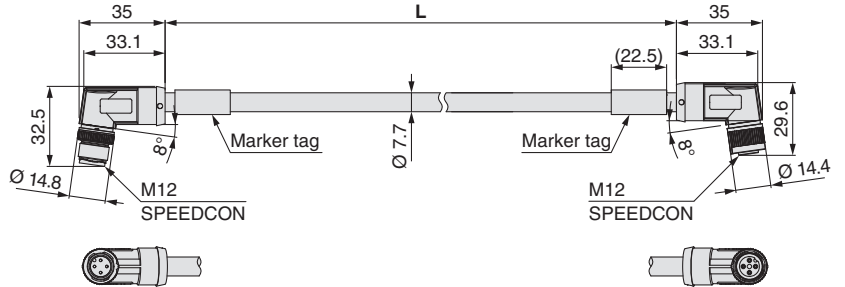

Plug connector pin arrangement A-coded (Normal key)

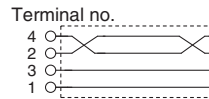

Connections

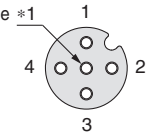
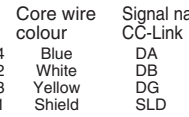

Socket connector pin arrangement A-coded (Normal key)

*1 Number of holes: 5, Total number of pins: 4

Item	Specifications
Cable O.D.	Ø 7.7 mm
Wire O.D. (Including insulator)	2.55 mm
Min. bending radius (Fixed)	77 mm

For DeviceNet™

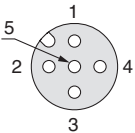
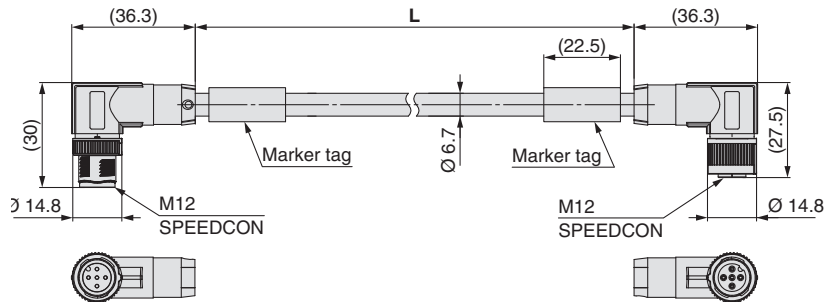

Plug connector pin arrangement A-coded (Normal key)

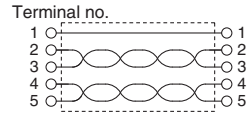

Connections

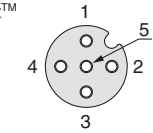
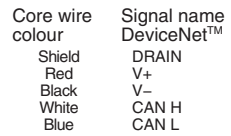

Socket connector pin arrangement A-coded (Normal key)

Item	Specifications	
Cable O.D.	Ø 6.7 mm	
Conductor nominal cross section	Power pair	0.32 mm ² /AWG22
	Data pair	0.2 mm ² /AWG24
Wire O.D. (Including insulator)	Power pair	1.4 mm
	Data pair	2.05 mm
Min. bending radius (Fixed)	67 mm	

EX260 Series

Communication Cable

- ③ With connector on one side (Socket)
Cable length: 10000 mm

For CC-Link For DeviceNet™

EX9-AC100 MJ -X12

• Applicable protocol

MJ	CC-Link
DN	DeviceNet™

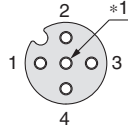

Socket connector pin arrangement A-coded (Normal key)

For CC-Link

Dimensions

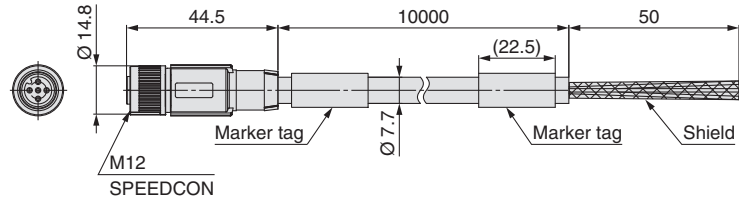

Connections

Terminal no.	Core wire colour: Signal name (CC-Link)
1	Shield: SLD
2	White: DB
3	Yellow: DG
4	Blue: DA

Item	Specifications
Cable O.D.	Ø 7.7 mm
Wire O.D. (Including insulator)	2.55 mm
Min. bending radius (Fixed)	77 mm

*1 Number of holes: 5, Total number of pins: 4

For DeviceNet™

Dimensions

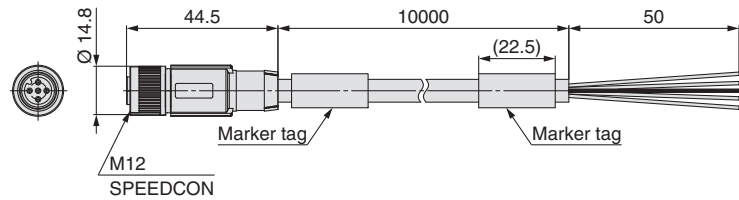

Connections

Terminal no.	Core wire colour: Signal name (DeviceNet™)
1	Shield: DRAIN
2	Red: V+
3	Black: V-
4	White: CAN H
5	Blue: CAN L

Item	Specifications	
Cable O.D.	Ø 6.7 mm	
Conductor nominal cross section	Power pair	0.32 mm ² /AWG22
	Data pair	0.2 mm ² /AWG24
Wire O.D. (Including insulator)	Power pair	1.4 mm
	Data pair	2.05 mm
Min. bending radius (Fixed)	67 mm	

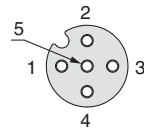

Socket connector pin arrangement A-coded (Normal key)

Communication Cable

④ With connector on both sides (Socket/Plug) **Dimensions**

For EtherCAT For PROFINET

For EtherNet/IP™

For Ethernet POWERLINK

EX9-AC 005 EN-PSPS-X19

● Cable length (L)

005	500 mm
010	1000 mm
020	2000 mm
030	3000 mm
050	5000 mm
100	10000 mm

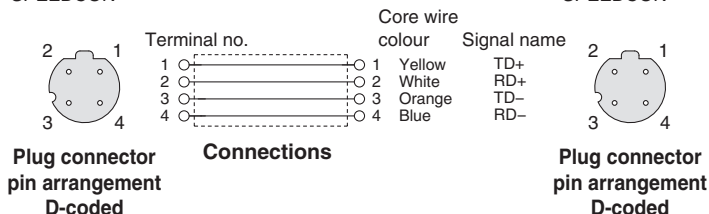
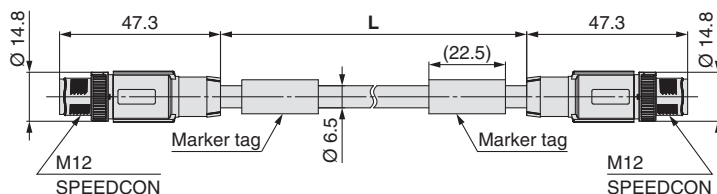

Item	Specifications
Cable O.D.	Ø 6.5 mm
Conductor nominal cross section	0.34 mm ² /AWG22
Wire O.D. (Including insulator)	1.5 mm
Min. bending radius (Fixed)	19.5 mm

⑤ With angle connector on both sides (Socket/Plug) **Dimensions**

For EtherCAT For PROFINET

For EtherNet/IP™

For Ethernet POWERLINK

EX9-AC 005 EN-PAPA-X19

● Cable length (L)

005	500 mm
010	1000 mm
020	2000 mm
030	3000 mm
050	5000 mm
100	10000 mm

Dimensions

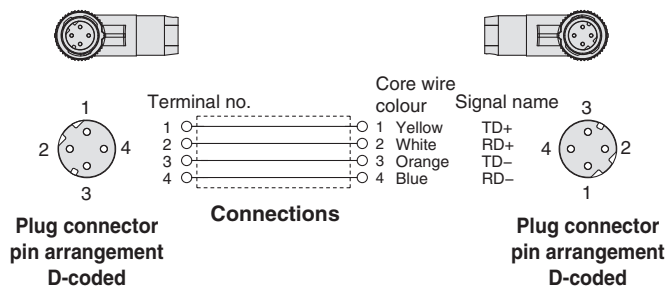
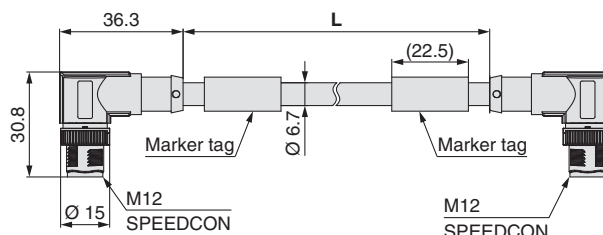

Item	Specifications
Cable O.D.	Ø 6.5 mm
Conductor nominal cross section	0.34 mm ² /AWG22
Wire O.D. (Including insulator)	1.5 mm
Min. bending radius (Fixed)	19.5 mm

EX260 Series

Power Supply Cable

① With connector on one side (Socket)

Cable length: 10000 mm

For CC-Link

For Power block

Dimensions

EX9-AC100-1-X16

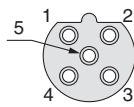
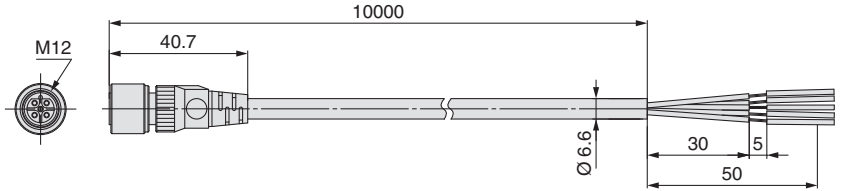

Socket connector
pin arrangement
B-coded (Reverse key)

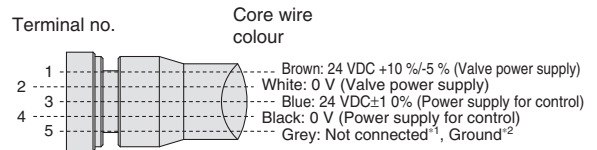

Connections

*1 For CC-Link
*2 For power block

Item	Specifications
Cable O.D.	Ø 6.6 mm
Conductor nominal cross section	0.3 mm ² /AWG22
Wire O.D. (Including insulator)	1.65 mm
Min. bending radius (Fixed)	40 mm

Power Supply Cable

② With connector on one side (Socket)

Cable length: 10000 mm

For PROFIBUS DP For DeviceNet™ For EtherCAT For PROFINET For EtherNet/IP™ For Ethernet POWERLINK

EX500-AP100-**S**-X1

• Connector specification

S	Straight
A	Angle

Straight connector type

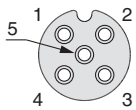
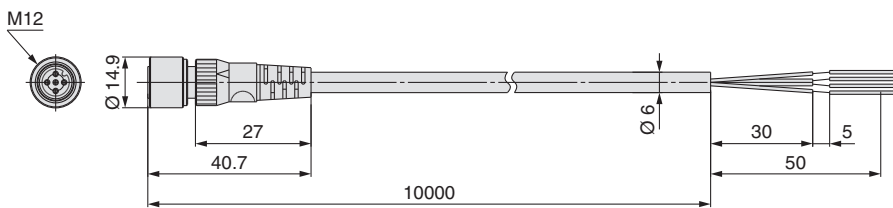

Socket connector pin arrangement A-coded

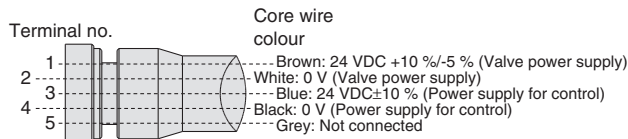

Connections (PROFIBUS DP/EtherCAT/PROFINET/Ethernet POWERLINK)

Item	Specifications
Cable O.D.	Ø 6 mm
Conductor nominal cross section	0.3 mm ² /AWG22
Wire O.D. (Including insulator)	1.5 mm
Min. bending radius (Fixed)	40 mm

Angle connector type

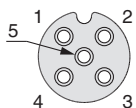
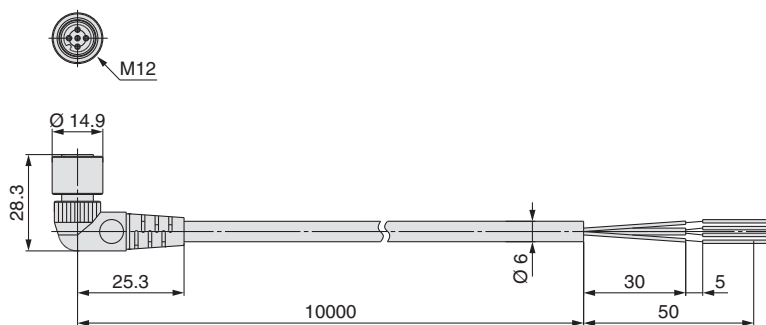

Socket connector pin arrangement A-coded

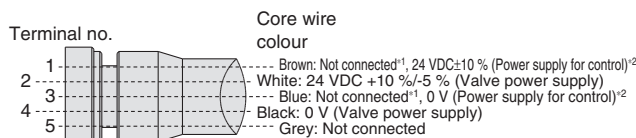

Connections (DeviceNet™, EtherNet/IP™) *1 For DeviceNet™ *2 For EtherNet/IP™

Item	Specifications
Cable O.D.	Ø 6 mm
Conductor nominal cross section	0.3 mm ² /AWG22
Wire O.D. (Including insulator)	1.5 mm
Min. bending radius (Fixed)	40 mm



EX260 Series

Specific Product Precautions

Be sure to read this before handling the products. For fieldbus system precautions, refer to the "Operation Manual" on the SMC website: www.smc.eu

Wiring

Caution

1. Select connectors that are $\varnothing 16$ or less if mounting manifolds directly using field-wireable connectors for SI unit power supply wiring.

Using large diameter connectors causes interference with the mounting surface.

The following cables with connectors are recommended.

■ For EX260-SPR□/-SDN□/-SEC□/-SPN□/-SEN□/-SPL□

<Cable with connector>

- EX500-AP□□□-□
- PCA-1401804/-1401805/-1401806

■ For EX260-SMJ□

<Cable with connector>

- EX9-AC□□□-1
- PCA-1401807/-1401808/-1401809

Adjustment / Operation

Caution

1. For details on programming and address setting, refer to the manual from the PLC manufacturer.

The content of programming related to protocol is designed by the manufacturer of the PLC used.

2. For the EX260-SPN□, the side of the SI unit may become hot.

It may cause burns.

Operating Environment

Caution

1. Select the proper type of enclosure according to the operating environment.

IP67 is achieved when the following conditions are met.

- 1) Provide appropriate wiring between all units using electrical wiring cables, communication connectors and cables with M12 connectors.
- 2) Appropriately mount each unit and valve manifold.
- 3) Be sure to mount a seal cap on any unused connectors.

If using in an environment that is exposed to water splashes, please take measures such as using a cover.

When the enclosure is IP40, do not use in an operating environment or atmosphere where it may come in contact with corrosive gas, chemical agents, seawater, water, or water vapor.

When connected to the EX260-SPR5/6/7/8, manifold enclosure is IP40.

■ Trademark

DeviceNet™ is a trademark of ODVA.

EtherNet/IP™ is a trademark of ODVA.

EtherCAT® is registered trademark and patented technology, licensed by Beckhoff Automation GmbH, Germany.

Modbus® is a registered trademark of Schneider Electric, licensed to the Modbus Organization, Inc.

QuickConnect™ is a trademark of ODVA.



Fieldbus System Precautions 1

Be sure to read this before handling products.

Design / Selection

Warning

- 1. Do not use beyond the specification range.**
Using beyond the specification range may result in a fire, malfunction, or damage to the system.
Check the specifications before operation.
- 2. When using for an interlock circuit:**
 - **Provide a multiple interlock system which is operated by another system (such as a mechanical protection function).**
 - **Perform an inspection to confirm that it is working properly.**
Failure to do so may result in possible injuries due to malfunction.

Caution

- 1. When applicable to UL, use a Class 2 power supply unit which is UL1310 compliant for direct current power supply.**
- 2. Use within the specified voltage range.**
Using beyond the specified voltage range is likely to cause damage product or malfunction.
- 3. Do not install in places where it can be used as a foothold.**
Applying any excessive load such as stepping on the product by mistake or placing a foot on it will cause it to break.
- 4. Keep the surrounding space free for maintenance.**
When designing a system, take into consideration the amount of free space needed to perform maintenance.
- 5. Do not remove the name plate.**
Improper maintenance or incorrect use of the Operation Manual may lead to equipment failure or malfunction. Also, there is a risk of losing conformity with safety standards.
- 6. Beware of inrush currents when the power supply is turned on.**
Some connected loads can apply an initial charge current which will trigger the over current protection function, causing the product to malfunction.

Mounting

Caution

- 1. When handling and assembling products:**
 - **Do not apply excessive force to the product when disassembling.**
The connecting parts of the product are firmly joined with seals.
 - **When joining units, take care not to get your fingers caught between the products.**
Injury may result.
- 2. Do not drop, bump, or apply excessive impact to the product.**
Doing so may result in damage, equipment failure, or malfunction.

Mounting

Caution

- 3. Observe the tightening torque range.**
Tightening outside of the allowable torque range will likely damage the screw.
IP65/IP67 cannot be guaranteed if the screws are not tightened to the specified torque.
- 4. When lifting a large solenoid valve manifold, take care to avoid causing stress to the valve connection joint.**
The connection parts of the product may be damaged.
Because the product may be heavy, carrying and installation should be performed by more than one operator to avoid strain or injury.
- 5. When installing the product, mount it on a flat surface.**
Torsion in the whole product may lead to problems such as air leakage or contact failure.

Wiring

Caution

- 1. Provide grounding to improve noise immunity.**
Perform the dedicated grounding separate from the inverter of the drive system and minimize the grounding distance from the product.
- 2. Avoid repeatedly bending or stretching the cable and applying heavy objects or force to it.**
Wiring where repeated bending and tensile stress are applied to the cable may result in circuit breakage.
- 3. Avoid miswiring.**
If miswired, there is a danger of malfunction or damage to the product.
- 4. Do not wire while energizing the product.**
There is a danger of malfunction or damage to the product or input/output device.
- 5. Avoid wiring the power line and high-pressure line in parallel.**
Signal line noise or surge from the power line or high-pressure line could cause a malfunction.
Wiring of the product or input/output device and the power line or high-pressure line should be separated from each other.
- 6. Check the wiring insulation.**
Defective insulation (contact with other circuits, improper insulation between terminals, etc.) may cause damage to the product or input/output device due to excessive voltage or current.



Fieldbus System Precautions 2

Be sure to read this before handling products.

Wiring

⚠ Caution

- 7. When the product is installed in machinery/equipment, provide adequate protection against noise by using noise filters, etc.**
Noise in signal lines may cause a malfunction.
- 8. When connecting wires, prevent the entry of water, solvent, or oil from the connector section.**
Failure to do so may result in damage, equipment failure, or malfunction.
- 9. Avoid wiring patterns in which excessive stress is applied to the connector.**
Failure to do so may result in equipment failure or malfunction due to contact failure.

Operating Environment

⚠ Warning

- 1. Do not use in atmospheres containing inflammable or explosive gases.**
Use in such atmospheres is likely to cause a fire or explosion. This product is not explosion proof.

⚠ Caution

- 1. Provide adequate protection when operating in locations such as the following.**
Failure to do so may cause a malfunction or equipment failure. The effect of countermeasures should be checked in individual equipment and machines.
 - 1) Where noise is generated by static electricity, etc.
 - 2) Where there is a strong electric field
 - 3) Where there is a danger of exposure to radiation
 - 4) When in close proximity to power lines or high-voltage lines
- 2. Do not use in environments where oil and chemicals are used.**
Operating in environments where coolants, cleaning solvents, various oils, or chemicals are present may cause adverse effects (damage, malfunction, etc.) to the product even within a short period of time.
- 3. Do not use in environments where the product could be exposed to corrosive gases or liquids.**
Use in such environments may cause product damage or malfunction.

Operating Environment

⚠ Caution

- 4. Do not use in locations with sources of surge generation.**
Installation of the product in an area around equipment (electromagnetic lifters, high-frequency induction furnaces, welding machines, motors, etc.) which generates large surge voltages could cause an internal circuitry element of the product to deteriorate or result in damage. Implement countermeasures against the surge from the generating source, and avoid contact between the lines.
- 5. When directly driving a load which generates a surge voltage by relay, solenoid valve, or lamp, use a load that has an integrated surge-absorption element.**
When a surge generating load is directly driven, the product may be damaged.
- 6. The product is CE marked but not immune to lightning strikes. Take measures against lightning strikes in your system.**
- 7. Keep dust, wire scraps, and other foreign matter from entering the product.**
Such materials may cause equipment failure or malfunction.
- 8. Mount the product in a location, which is not affected by vibration or shock.**
Failure to do so may cause equipment failure or malfunction.
- 9. Do not use in places where there are cyclic temperature changes.**
When the cyclic temperature exceeds normal temperature changes, the internal product is likely to be adversely affected.
- 10. Do not use in direct sunlight.**
This may cause equipment failure or malfunction.
- 11. Use within the ambient temperature range.**
Failure to do so may cause a malfunction.
- 12. Do not use in places where radiated heat may affect the product.**
Such places are likely to cause a malfunction.



Fieldbus System Precautions 3

Be sure to read this before handling products.

Adjustment / Operation

Warning

1. **Do not perform operation or setting with wet hands.**
There is a risk of electrical shock.

Caution

1. **Use a watchmaker's screwdriver with a thin blade for the setting switch.**
When setting the switch, do not touch any unrelated parts. This may cause parts damage or malfunction due to a short circuit.
2. **Perform appropriate setting for the operating conditions.**
Failure to do so could result in malfunction. Refer to the Operation Manual for details on setting each switch.
3. **For details on programming and address setting, refer to the manual from the PLC manufacturer.**
The programming content related to the protocol is designed by the manufacturer of the PLC used.

Maintenance

Warning

1. **Do not disassemble, modify (including circuit board replacement), or repair this product.**
Such actions are likely to cause injuries or equipment failure.
2. **When an inspection is performed:**
 - Turn off the power supply.
 - Stop the air supply, exhaust the residual pressure in the piping, and confirm that the air has been released before performing maintenance work.Failure to do so may result in the unexpected malfunction of system components or injury.

Caution

1. **When removing from/attaching to the valve manifold:**
 - Do not apply excessive force to the unit.
The connecting parts are firmly joined with seals.
 - Take care not to get your fingers caught.
Injury may result.
2. **Perform periodic inspection.**
Unexpected malfunction in the system composition devices is likely to occur due to malfunction of machinery or equipment.
3. **After maintenance, make sure to perform an appropriate functionality inspection.**
When abnormalities such as faulty operation occur, stop operation immediately. Unexpected malfunction in the system composition devices is likely to occur.
4. **Do not use benzine or thinner for cleaning the product.**
Damage to the surface or erasure of the display may result. Wipe off any stains with a soft cloth. If the stain is persistent, soak a cloth in a dilute solution of neutral detergent, wring it out sufficiently, wipe the product, and then finish with a dry cloth.



Other

Caution

1. Refer to the catalogue of each series for Common Precautions and Specific Product Precautions for valve manifolds.

Safety Instructions

These safety instructions are intended to prevent hazardous situations and/or equipment damage. These instructions indicate the level of potential hazard with the labels of “Caution,” “Warning” or “Danger.” They are all important notes for safety and must be followed in addition to International Standards (ISO/IEC)*1, and other safety regulations.

-  **Caution:** Caution indicates a hazard with a low level of risk which, if not avoided, could result in minor or moderate injury.
-  **Warning:** Warning indicates a hazard with a medium level of risk which, if not avoided, could result in death or serious injury.
-  **Danger:** Danger indicates a hazard with a high level of risk which, if not avoided, will result in death or serious injury.

- *1) ISO 4414: Pneumatic fluid power – General rules relating to systems.
 ISO 4413: Hydraulic fluid power – General rules relating to systems.
 IEC 60204-1: Safety of machinery – Electrical equipment of machines.
 (Part 1: General requirements)
 ISO 10218-1: Manipulating industrial robots - Safety.
 etc.

Warning

1. The compatibility of the product is the responsibility of the person who designs the equipment or decides its specifications.

Since the product specified here is used under various operating conditions, its compatibility with specific equipment must be decided by the person who designs the equipment or decides its specifications based on necessary analysis and test results. The expected performance and safety assurance of the equipment will be the responsibility of the person who has determined its compatibility with the product. This person should also continuously review all specifications of the product referring to its latest catalogue information, with a view to giving due consideration to any possibility of equipment failure when configuring the equipment.

2. Only personnel with appropriate training should operate machinery and equipment.

The product specified here may become unsafe if handled incorrectly. The assembly, operation and maintenance of machines or equipment including our products must be performed by an operator who is appropriately trained and experienced.

3. Do not service or attempt to remove product and machinery/equipment until safety is confirmed.

1. The inspection and maintenance of machinery/equipment should only be performed after measures to prevent falling or runaway of the driven objects have been confirmed.
2. When the product is to be removed, confirm that the safety measures as mentioned above are implemented and the power from any appropriate source is cut, and read and understand the specific product precautions of all relevant products carefully.
3. Before machinery/equipment is restarted, take measures to prevent unexpected operation and malfunction.

4. Contact SMC beforehand and take special consideration of safety measures if the product is to be used in any of the following conditions.

1. Conditions and environments outside of the given specifications, or use outdoors or in a place exposed to direct sunlight.
2. Installation on equipment in conjunction with atomic energy, railways, air navigation, space, shipping, vehicles, military, medical treatment, combustion and recreation, or equipment in contact with food and beverages, emergency stop circuits, clutch and brake circuits in press applications, safety equipment or other applications unsuitable for the standard specifications described in the product catalogue.
3. An application which could have negative effects on people, property, or animals requiring special safety analysis.
4. Use in an interlock circuit, which requires the provision of double interlock for possible failure by using a mechanical protective function, and periodical checks to confirm proper operation.

Limited warranty and Disclaimer/ Compliance Requirements

The product used is subject to the following “Limited warranty and Disclaimer” and “Compliance Requirements”.
 Read and accept them before using the product.

Limited warranty and Disclaimer

1. The warranty period of the product is 1 year in service or 1.5 years after the product is delivered, whichever is first.*2) Also, the product may have specified durability, running distance or replacement parts. Please consult your nearest sales branch.
2. For any failure or damage reported within the warranty period which is clearly our responsibility, a replacement product or necessary parts will be provided. This limited warranty applies only to our product independently, and not to any other damage incurred due to the failure of the product.
3. Prior to using SMC products, please read and understand the warranty terms and disclaimers noted in the specified catalogue for the particular products.

*2) Vacuum pads are excluded from this 1 year warranty.

A vacuum pad is a consumable part, so it is warranted for a year after it is delivered. Also, even within the warranty period, the wear of a product due to the use of the vacuum pad or failure due to the deterioration of rubber material are not covered by the limited warranty.

Compliance Requirements

1. The use of SMC products with production equipment for the manufacture of weapons of mass destruction (WMD) or any other weapon is strictly prohibited.
2. The exports of SMC products or technology from one country to another are governed by the relevant security laws and regulations of the countries involved in the transaction. Prior to the shipment of a SMC product to another country, assure that all local rules governing that export are known and followed.

Caution

1. The product is provided for use in manufacturing industries.

The product herein described is basically provided for peaceful use in manufacturing industries.

If considering using the product in other industries, consult SMC beforehand and exchange specifications or a contract if necessary.

If anything is unclear, contact your nearest sales branch.

Caution

SMC products are not intended for use as instruments for legal metrology.

Measurement instruments that SMC manufactures or sells have not been qualified by type approval tests relevant to the metrology (measurement) laws of each country. Therefore, SMC products cannot be used for business or certification ordained by the metrology (measurement) laws of each country.

Safety Instructions

Be sure to read “Handling Precautions for SMC Products” (M-E03-3) before using.

SMC Corporation (Europe)

Austria	+43 (0)2262622800	www.smc.at	office@smc.at	Lithuania	+370 5 2308118	www.smc.lt	info@smc.lt
Belgium	+32 (0)33551464	www.smc.be	info@smc.be	Netherlands	+31 (0)205318888	www.smc.nl	info@smc.nl
Bulgaria	+359 (0)2807670	www.smc.bg	office@smc.bg	Norway	+47 67129020	www.smc-norge.no	post@smc-norge.no
Croatia	+385 (0)13707288	www.smc.hr	office@smc.hr	Poland	+48 222119600	www.smc.pl	office@smc.pl
Czech Republic	+420 541424611	www.smc.cz	office@smc.cz	Portugal	+351 226166570	www.smc.eu	postpt@smc.smces.es
Denmark	+45 70252900	www.smc.dk.com	smc@smcdk.com	Romania	+40 213205111	www.smcromania.ro	smcromania@smcromania.ro
Estonia	+372 6510370	www.smc.ee	smc@smcpneumatics.ee	Russia	+7 8127185445	www.smc-pneumatik.ru	info@smc-pneumatik.ru
Finland	+358 207513513	www.smc.fi	smc@smc.fi	Slovakia	+421 (0)413213212	www.smc.sk	office@smc.sk
France	+33 (0)164761000	www.smc-france.fr	info@smc-france.fr	Slovenia	+386 (0)73885412	www.smc.si	office@smc.si
Germany	+49 (0)61034020	www.smc.de	info@smc.de	Spain	+34 902184100	www.smc.es	post@smc.smces.es
Greece	+30 210 2717265	www.smc-hellas.gr	sales@smc-hellas.gr	Sweden	+46 (0)86031200	www.smc.se	post@smc.se
Hungary	+36 23513000	www.smc.hu	office@smc.hu	Switzerland	+41 (0)523963131	www.smc.ch	info@smc.ch
Ireland	+353 (0)14039000	www.smc-pneumatics.ie	sales@smc-pneumatics.ie	Turkey	+90 212 489 0 440	www.smc-pneumatik.com.tr	info@smc-pneumatik.com.tr
Italy	+39 0292711	www.smc-italia.it	mailbox@smc-italia.it	UK	+44 (0)845 121 5122	www.smc-pneumatics.co.uk	sales@smc.uk
Latvia	+371 67817700	www.smc.lv	info@smc.lv				

SMC CORPORATION Akihabara UDX 15F, 4-14-1, Sotokanda, Chiyoda-ku, Tokyo 101-0021, JAPAN Phone: 03-5207-8249 FAX: 03-5298-5362