



Operation Manual

PRODUCT NAME

Multi-channel Digital Sensor Monitor

MODEL / Series / Product Number

PSE20#A

SMC Corporation

Table of Contents

Safety Instructions	3
Model Indication and How to Order	9
Summary of Product parts	10
Definition and terminology	11
Mounting and Installation	14
Installation	14
Wiring	16
Pressure Setting	19
Outline of Settings	20
Initial Setting	22
3 Step Setting Mode	26
Simple Setting Mode	28
Function Selection Mode	30
Function selection mode	30
Default setting	30
F 0 Differential pressure check mode, pressure range, display unit	32
F 1 Setting of OUT1	38
F 2 Setting of OUT2	41
F 3 Digital filter setting	43
F 4 Auto-preset function	44
F 5 Auto-shift setting	46
F 6 Fine adjustment of display value	48
F10 Sub display setting	49
F11 Display resolution setting	55
F14 Zero cut-off setting	56
F80 Power saving mode	57
F81 Security code	58
F90 Setting of all functions	60
F95 Channel to channel copy function setting	62
F96 Sensor input/External input signal status display	63
F98 Output check	64
F99 Reset to default settings	66
Other Settings	67
Maintenance	71
Forgotten the security code	71
Troubleshooting	72
Specifications	80
Dimensions	82



Safety Instructions

These safety instructions are intended to prevent hazardous situations and/or equipment damage. These instructions indicate the level of potential hazard with the labels of “**Caution**,” “**Warning**” or “**Danger**.” They are all important notes for safety and must be followed in addition to International Standards (ISO/IEC)^{*)}, and other safety regulations.

*1) ISO 4414: Pneumatic fluid power - General rules and safety requirements for systems and their components
ISO 4413: Hydraulic fluid power - General rules and safety requirements for systems and their components
IEC 60204-1: Safety of machinery - Electrical equipment of machines - Part 1: General requirements
ISO 10218-1: Robots and robotic devices - Safety requirements for industrial robots - Part 1: Robots
etc.



Danger

Danger indicates a hazard with a high level of risk which, if not avoided, will result in death or serious injury.



Warning

Warning indicates a hazard with a medium level of risk which, if not avoided, could result in death or serious injury.



Caution

Caution indicates a hazard with a low level of risk which, if not avoided, could result in minor or moderate injury.

Warning

1. The compatibility of the product is the responsibility of the person who designs the equipment or decides its specifications.

Since the product specified here is used under various operating conditions, its compatibility with specific equipment must be decided by the person who designs the equipment or decides its specifications based on necessary analysis and test results. The expected performance and safety assurance of the equipment will be the responsibility of the person who has determined its compatibility with the product. This person should also continuously review all specifications of the product referring to its latest catalog information, with a view to giving due consideration to any possibility of equipment failure when configuring the equipment.

2. Only personnel with appropriate training should operate machinery and equipment.

The product specified here may become unsafe if handled incorrectly. The assembly, operation and maintenance of machines or equipment including our products must be performed by an operator who is appropriately trained and experienced.

3. Do not service or attempt to remove product and machinery/equipment until safety is confirmed.

1. The inspection and maintenance of machinery/equipment should only be performed after measures to prevent falling or runaway of the driven objects have been confirmed.
2. When the product is to be removed, confirm that the safety measures as mentioned above are implemented and the power from any appropriate source is cut, and read and understand the specific product precautions of all relevant products carefully.
3. Before machinery/equipment is restarted, take measures to prevent unexpected operation and malfunction.

4. Our products cannot be used beyond their specifications. Our products are not developed, designed, and manufactured to be used under the following conditions or environments. Use under such conditions or environments is not covered.

1. Conditions and environments outside of the given specifications, or use outdoors or in a place exposed to direct sunlight.
2. Use for nuclear power, railways, aviation, space equipment, ships, vehicles, military application, equipment affecting human life, body, and property, fuel equipment, entertainment equipment, emergency shut-off circuits, press clutches, brake circuits, safety equipment, etc., and use for applications that do not conform to standard specifications such as catalogs and operation manuals.
3. Use for interlock circuits, except for use with double interlock such as installing a mechanical protection function in case of failure. Please periodically inspect the product to confirm that the product is operating properly.



Safety Instructions

Caution

We develop, design, and manufacture our products to be used for automatic control equipment, and provide them for peaceful use in manufacturing industries.

Use in non-manufacturing industries is not covered.

Products we manufacture and sell cannot be used for the purpose of transactions or certification specified in the Measurement Act.

The new Measurement Act prohibits use of any unit other than SI units in Japan.

Limited warranty and Disclaimer/Compliance Requirements

The product used is subject to the following “Limited warranty and Disclaimer” and “Compliance Requirements”.

Read and accept them before using the product.

Limited warranty and Disclaimer

1. The warranty period of the product is 1 year in service or 1.5 years after the product is delivered, whichever is first.*2)

Also, the product may have specified durability, running distance or replacement parts. Please consult your nearest sales branch.

2. For any failure or damage reported within the warranty period which is clearly our responsibility, a replacement product or necessary parts will be provided.

This limited warranty applies only to our product independently, and not to any other damage incurred due to the failure of the product.

3. Prior to using SMC products, please read and understand the warranty terms and disclaimers noted in the specified catalog for the particular products.

***2) Vacuum pads are excluded from this 1 year warranty.**

A vacuum pad is a consumable part, so it is warranted for a year after it is delivered.

Also, even within the warranty period, the wear of a product due to the use of the vacuum pad or failure due to the deterioration of rubber material are not covered by the limited warranty

Compliance Requirements

1. The use of SMC products with production equipment for the manufacture of weapons of mass destruction (WMD) or any other weapon is strictly prohibited.

2. The exports of SMC products or technology from one country to another are governed by the relevant security laws and regulations of the countries involved in the transaction. Prior to the shipment of a SMC product to another country, assure that all local rules governing that export are known and followed.

Operator

- ◆ This operation manual is intended for those who have knowledge of machinery using pneumatic equipment, and have sufficient knowledge of assembly, operation and maintenance of such equipment. Only those persons are allowed to perform assembly, operation and maintenance.
- ◆ Read and understand this operation manual carefully before assembling, operating or providing maintenance to the product.

■ Safety Instructions

Warning

- Do not disassemble, modify (including changing the printed circuit board) or repair.
An injury or failure can result.
- Do not operate the product outside of the specifications.
Do not use for flammable or harmful fluids.
Fire, malfunction, or damage to the product can result.
Verify the specifications before use.
- Do not operate in an atmosphere containing flammable or explosive gases.
Fire or an explosion can result.
This product is not designed to be explosion proof.
- Do not use the product in a place where static electricity is a problem.
Otherwise it can cause failure or malfunction of the system.
- If using the product in an interlocking circuit:
 - Provide a double interlocking system, for example a mechanical system
 - Check the product regularly for proper operationOtherwise malfunction can result, causing an accident.
- The following instructions must be followed during maintenance:
 - Turn off the power supply
 - Stop the air supply, exhaust the residual pressure and verify that the air is released before performing maintenanceOtherwise an injury can result.

Caution

- Do not touch the terminals and connectors while the power is on.
Otherwise electric shock, malfunction or damage to the product can result.
- After maintenance is complete, perform appropriate functional inspections and leak tests.
Stop operation if the equipment does not function properly or there is a leakage of fluid.
When leakage occurs from parts other than the piping, the product might be faulty.
Disconnect the power supply and stop the fluid supply.
Do not apply fluid under leaking conditions.
Safety cannot be assured in the case of unexpected malfunction.

■ NOTE

- Follow the instructions given below when designing, selecting and handling the product.
 - The instructions on design and selection (installation, wiring, environment, adjustment, operation, maintenance, etc.) described below must also be followed.
 - *Product specifications
 - Use the specified voltage.
Otherwise failure or malfunction can result.
 - Use the specified pressure sensor.
Otherwise the product may be broken and it will not be able to perform proper measurement.
 - Do not exceed the specified maximum allowable load.
Otherwise it can cause damage or shorten the lifetime of the product.
 - Design the product to prevent reverse current when the circuit is opened or the product is forced to operate for operational check.
Reverse current can cause malfunction or damage to the product.
 - Input data to the product is not deleted, even if the power supply is cut off.
(Writing time: 10,000 times, Data duration: 20 years after power off)
 - Reserve a space for maintenance.
Allow sufficient space for maintenance when designing the system.

●Product handling

*Installation

- Tighten to the specified tightening torque.

If the tightening torque is exceeded the mounting screws and brackets may be broken.

If the tightening torque is insufficient, the product can be displaced and loosen the mounting screws.

- Be sure to ground terminal FG when using a commercially available switch-mode power supply.
- Do not drop, hit or apply shock to the product.

Otherwise damage to the internal parts can result, causing malfunction.

- Do not pull the lead wire forcefully, not lift the product by pulling the lead wire.

(Tensile strength: 50 N maximum for power supply and output cable, 25 N maximum for sensor lead wire with connector).

Hold the body when handling to avoid the damage of the product which lead to cause the failure and malfunction.

- Never mount the product in a place that will be used as a scaffold during piping.

The product may be damaged if excessive force is applied by stepping or climbing onto it.

*Wiring

- Do not pull the lead wires. In particular, do not lift or carry the product by holding the cables once they are connected to the product.

Otherwise damage to the internal parts can result, causing malfunction or to be off the connector.

- Avoid repeatedly bending or stretching the lead wire, or placing heavy load on them.

If the lead wire can move, fix it near the body of the product.

The recommended bend radius of the lead wire is 6 times the outside diameter of the sheath, or 33 times the outside diameter of the insulation material, whichever is larger.

Replace the damaged lead wire with a new one.

- Wire correctly.

Incorrect wiring can break the product.

- Do not perform wiring while the power is on.

Otherwise damage to the internal parts can result, causing malfunction.

- Do not route wires and cables together with power or high voltage cables.

Otherwise the product can malfunction due to interference of noise and surge voltage from power and high voltage cables to the signal line. Route the wires (piping) of the product separately from power or high voltage cables.

- Confirm proper insulation of wiring.

Poor insulation (interference from another circuit, poor insulation between terminals, etc.) can lead to excess voltage or current being applied to the product, causing damage.

- Design the system to prevent reverse current when the product is forced to operate for operational check.

Depending on the circuit used, insulation may not be maintained when operation is forced, allowing reverse current to flow, which can cause malfunction and damage the product.

- Keep wiring as short as possible to prevent interference from electromagnetic noise and surge voltage.

Do not use a cable longer than 30 m.

Wire the DC(-) line(blue) as close as possible to the power supply.

*Environment

- Do not use the product in area that is exposed to corrosive gases, chemicals, sea water, water or steam. Otherwise failure or malfunction can result.

- Do not use the product in an environment where the product is constantly exposed to water or oil splashes.

If the product is to be used in an environment containing oils or chemicals such as coolant or cleaning solvent, it may be adversely affected (damage, malfunction, or hardening of the lead wires).

- Do not use in an area where surges are generated.

If there is equipment which generates a large amount of surge (solenoid type lifter, high frequency induction furnace, motor, etc.) close to the product, this may cause deterioration or breakage of the internal circuit of the product. Avoid sources of surge generation and crossed lines.

- Do not use a load which generates surge voltage.
When a surge-generating load such as a relay or solenoid is driven directly, use a load with a built-in surge suppressor.
- The product is CE/UKCA marked, but not immune to lightning strikes. Take measures against lightning strikes in the system.
- Mount the product in a place that is not exposed to vibration or impact.
Otherwise failure or malfunction can result.
- Prevent foreign matter such as remnant of wires from entering the product.
Take proper measures for the remnant not to enter the product in order to prevent failure or malfunction.
- Do not use the product in an environment that is exposed to temperature cycle.
Heat cycles other than ordinary changes in temperature can adversely affect the inside of the product.
- Do not expose the product to direct sunlight.
If using in a location directly exposed to sunlight, shade the product from the sunlight.
Otherwise failure or malfunction can result.
- Keep within the specified ambient temperature range.
The ambient temperature range is 0 to 50 °C. Operation at low temperature (5 °C or less) may cause damage or operation failure due to frozen moisture in the air.
Protection against freezing is necessary.
Avoid sudden temperature change even within specified temperature.
- Do not operate close to a heat source, or in a location exposed to radiant heat.
Otherwise malfunction can result.

*Adjustment and Operation

- Turn the power on after connecting a load.
Otherwise it can cause excess current causing instantaneous breakage of the product.
- Do not short-circuit the load.
Although error is displayed when the load at the output part has a short circuit, generated over current may lead to the damage of the product.
- Do not press the setting buttons with a sharp pointed object.
It may damage the setting buttons.
- If using the product to detect very small pressure rates, warm up the product for 10 to 15 minutes first.
There will be a drift on the display of approximate $\pm 1\%$ immediately after the power supply is turned on, within 10 minutes.
- Perform settings suitable for the operating conditions.
Incorrect setting can cause operation failure.
For details of each setting, refer to page 19 to 70 of this manual.
- Do not touch the LCD during operation.
The display can vary due to static electricity.

*Maintenance

- Turn OFF the power supply before maintenance.
There is a risk of unexpected malfunction.
- Perform regular maintenance and inspections.
There is a risk of unexpected malfunction.
- Do not use solvents such as benzene, thinner etc. to clean the product.
They could damage the surface of the body and erase the markings on the body.
Use a soft cloth to remove stains. For heavy stains, use a cloth soaked with diluted neutral detergent and fully squeezed, then wipe up the stains again with a dry cloth.

Model Indication and How to Order

PSE20 0 A- M

I/O specification

Symbol	Content
0	NPN 5 outputs + Auto-shift input
1	PNP 5 outputs + Auto-shift input

Unit specification

Symbol	Content
Nil	With units selection function ^{*1}
M	Fixed SI unit ^{*2}

*1: The new Measurement Law prohibits the use of pressure switch with the units selection function in Japan.
A unit label is attached.

*2: Fixed unit kPa, MPa, Pa

Option 3

Symbol	Content
Nil	Power supply/output cable (2 m)
N	No option

*5: Cable is shipped together with the product.

Option 2

Symbol	Content
Nil	No option
4C	Connector for sensor lead wire (4 pcs.)

*4: Connector is shipped together with the product.

Option 1

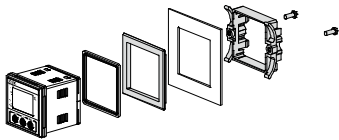
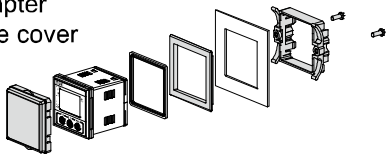
Symbol	Content
Nil	No option
A	Panel mount adapter 
B	Panel mount adapter + Front protective cover 

*3: Option is shipped together with the product.

○Accessories/Part numbers

Items	Part No.	Remarks
Power supply/output cable	ZS-26-L	Length 2 m
Connector for sensor lead wire	ZS-28-C	1 pc.
Panel mount adapter	ZS-26-B	With set screw M3 x 8L (2 pcs.) and waterproof seal
Panel mount adapter + Front protective cover	ZS-26-C	With set screw M3 x 8L (2 pcs.) and waterproof seal
Front protective cover	ZS-26-01	-
□48 conversion adapter	ZS-26-D	It is an adapter for attaching PSE200A series in the panel cut size of PSE100 series.

Summary of Product parts

Names of individual parts

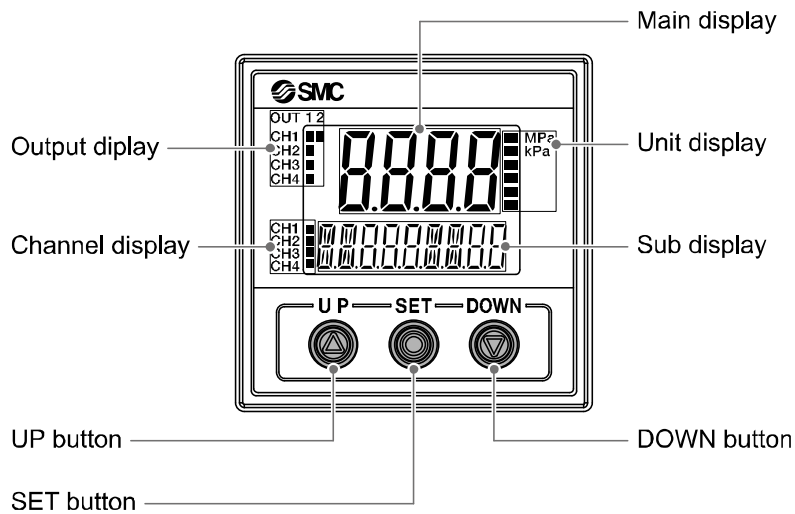

Output display (Orange): Lit when OUT1 (CH1 to CH4) and/or OUT2 (only CH1) is ON.

Main display (Red/Green): Displays the current status of pressure, setting mode, selected indication unit and error code.

UP button: Selects the channel and mode, and increases the ON/OFF set value.

DOWN button: Changes the sub display, selects the mode and decreases the ON/OFF set value.

SET button: Changes the mode and sets a set value.

Unit display (Red/Green): Lit ON the indicator of selected unit. For the Controller without unit selection function, the unit is fixed to SI (MPa, kPa or Pa).

Unit label: Attach the unit label (kgf/cm², bar, psi, inHg, mmHg, Pa, mbar, mmH₂O) with a unit selection function.

LCD of corresponding unit turns on as follows:

- **MPa** When MPa is selected
- **kPa** When kPa is selected
- When kgf/cm² is selected
- When bar is selected
- When psi is selected
- When unit other than above is selected

Channel display (Orange): Indicate the CH1 to CH4 that is selected at that time.

Sub display (left) (Orange): Displays items.

Sub display (right) (Orange): Displays set values, peak and bottom values.

■ Definition and terminology

	Term	Definition
A	Auto-preset	Performs pressure setting automatically by detecting the increase and decrease in pressure. For example, if this function is used for a suction test, the pressure setting will be completed by performing suction and release of the workpiece.
B	Bottom value display (mode)	Shows the minimum pressure from when the power was supplied to the current time.
C	Chattering	The problem of the switch output turning ON and OFF repeatedly around the set value at high frequency due to the effect of pulsation.
	Chattering prevention function	A function to delay the response time of switch output in order to prevent chattering.
D	Delay time	The setting time from when the input signal reaches the set value, to when the ON-OFF output actually begins working. Delay time setting can prevent the output from chattering.
	digit (Min. setting unit)	Shows how precisely the pressure can be displayed or set. When 1 digit = 1 kPa, the pressure is displayed in increments of 1 kPa, e.g., 1, 2, 3, ..., 99, 100.
	Digital filter	Function to add digital filtering to the fluctuation of input value. Smooth the fluctuation of displayed value for sharp start up or fall of the pressure. When the function is valid, digital filtering is reflected to the ON/OFF of the switch output. Output chattering or flicker in the measurement mode display can be reduced by setting the digital filter. The response time indicates when the set value is 90% in relation to the step input.
	Display accuracy	Shows The maximum deviation between the displayed pressure value and the true pressure.
	Display colour	Indicates the colour of the number of digital display. Always green, always red, green (switch OFF) → red (switch ON), red (switch OFF) → green (switch ON) are available.
	Display resolving power	Indicate in how many the rated pressure range can be divided to display. (Example: When the value can be displayed down to 0.001 MPa for the product for 0 to 1 Mpa, the resolution is 1/1000)
	Display value fine adjustment (function)	Displayed pressure value can be adjusted within the range of $\pm 5\%$ R.D. ($\pm 5\%$ of displayed value). It is used if the true pressure value is known, or to eliminate differences between the displayed values of different instruments that are measuring the same pressure.
E	Error displayed	A code number displayed to identify the error code detected by the self-diagnostic function of the product. Refer to "Error indication function" on page 78 for details of the errors.
	Error output	Switches the switch output to ON/OFF when an error is displayed. Refer to "List of output modes" on page 40 for operating conditions. Refer to "Error indication function" on page 78 for details of the errors.

	Term	Definition
F	F.S. (full span/full scale)	Abbreviation of full span and full scale; difference between the minimum and maximum rated pressure values. means the maximum fluctuation range of the pressure switch rated value. For example, when the rated pressure range is -0.100 to 1.000 [MPa]: F.S. = 1.000 - (-0.100) = 1.100 [MPa] (Reference: 1%F.S. = 1.100 x 0.01 = 0.011 [MPa])
	Fine adjustment mode	Refer to "Display value fine adjustment (function)".
	Fluid contact part (or wetted part)	Part of the product which contacts detected fluid. Pressure sensor, seal and fitting are included.
	Function selection mode	A mode in which setting of functions is performed. It is a separate menu from the pressure setting. If any function settings need to be changed from the factory default, each setting can be selected with "F*". The setting items are: display colour, operation mode, output type, digital filter, display resolution, display value fine adjustment, use of auto preset, use of power saving mode, security code, etc.
H	Hysteresis	Difference between the ON and OFF points of switch output.
	Hysteresis mode	Refer to the "List of output modes" on page 40.
I	Insulation resistance	Insulation resistance of the product. The resistance between the electrical circuit and the case.
K	Key-lock function	Function that prevents changes to the settings of the product (disables button operation).
M	Manual setting	Manual pressure setup without using auto preset. This term is used to distinguish between manual and auto preset pressure setup.
	Maximum applied voltage	The maximum voltage that can be connected to the output of an NPN device.
	Maximum load current	The maximum current that can flow to the output (output line) of the switch output.
	Measurement mode	Operating condition in which pressure is being detected and displayed, and the switch function is working.
	Min. setting unit	Refer to "digit".
N	Normal output	One of the switch output types. In hysteresis mode the switch output is turned ON when pressure equal to or greater than the switch output set value is detected. In window comparator mode, the switch output is turned ON when pressure between the switch output set values (P1L to P1H) is detected. (Refer to the "List of output modes" on page 40.)
O	Operation light	A light that turns on when the switch output is ON.
	Operation mode	Either hysteresis mode or window comparator mode can be selected.
	Output style	The operation principle of the switch output. Normal output and reverse output can be selected. Please refer to the "List of output modes" on page 40 operating conditions.

	Term	Definition
P	Peak value display (mode)	Shows the maximum pressure from when the power was supplied to the current time.
	Port size	The diameter of the connecting part of the product for connecting with the object to be measured.
	Power saving mode	Operating mode in which the digital display turns off and power consumption is reduced.
	Pressure setting	The set pressure value that determines the point at which the switch output turns ON and OFF.
	Proof pressure	Pressure limit that if exceeded will result in mechanical and/or electrical damage to the product.
R	R.D.	Current read value For example, when the display value is 1.000[MPa], $\pm 5\%$ R.D. is $\pm 5\%$ of 1.000[MPa], which becomes ± 0.05 [MPa]. When the display value is 0.800[MPa], $\pm 5\%$ R.D. is $\pm 5\%$ of 0.800[MPa], which becomes ± 0.04 [MPa].
	Rated pressure range	The pressure range within which the product will meet all published specifications. Values outside of this range can be set as long as they are within the set pressure range, but the specifications cannot be guaranteed.
	Repeatability	Variation in repeated measurement of pressure display or ON-OFF output point when the pressure changes at 25 centigrade.
	Residual voltage	The difference between the ideal ON voltage and the actual voltage when the switch output is on. Varies with load current. Ideally should be 0 V.
	Resolution	Refer to "Display resolution".
	Reversed output	One of the switch output types. In hysteresis mode the switch output is turned ON when pressure less than or equal to the switch output set value is detected. In window comparator mode, the switch output is turned ON when pressure is outside the switch output set values (n1L to n1H) is detected. (Refer to the "List of output modes" on page 40.)
	Ripple	A type of chattering.
S	Set pressure range	The pressure range that can be set for switch output.
	Switch output	Sometimes referred to as "ON-OFF output".
U	Units selection function	A function to change the units in which the measured pressure value is displayed. The display units can only be changed if the product is equipped this function. It is not possible to purchase the product with this function if the product is used in Japan. The product for Japan is displayed in SI only.
W	Window comparator mode	An operating mode in which the switch output is turned on and off depending on whether the flow is inside or outside the range of two set values. (Refer to the "List of output modes" on page 40.)
	Withstand voltage	A measure of the product's resistance to a voltage applied between the electrical circuit and case. Durability in withstanding voltage. The product may be damaged if a voltage over this value is applied. (The withstand voltage is not the supply voltage used to power the product.)
Z	Zero-clear function	This function to adjust the displayed pressure to zero.

Mounting and Installation

■ Installation

○ Mounting by panel mount adapter

- Fix the panel mount adapter to the Controller with the set screws M3 x 8L (2 pcs.) as attached.
- Panel mount adapter (Model: ZS-26-B)
- Panel mount adapter + Front protective cover (Model: ZS-26-01)
- 48 conversion adapter (Model: ZS-26-D)

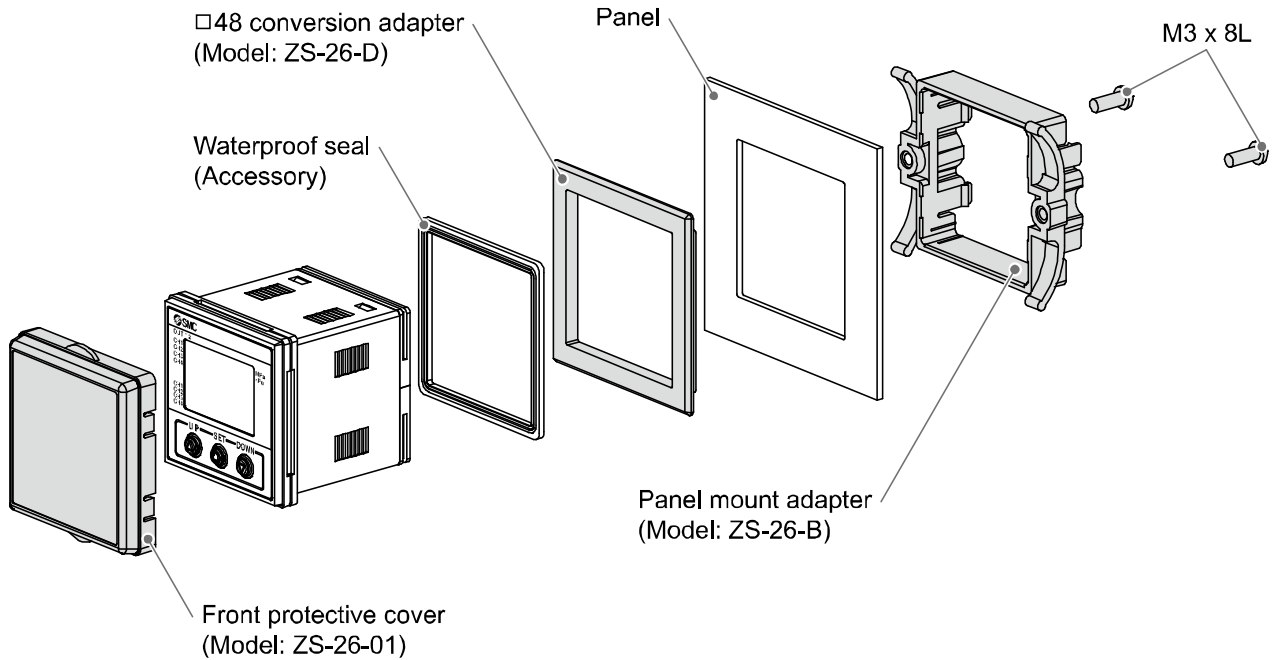

*: The panel mount adapter can be rotated by 90 degrees for mounting.

*: Front panel of this Controller meets IP65 (if □48 conversion adapter is used, it meets IP40). However, if the panel mount adapter is hold enough with screw and the instrument is not seated correctly, water might enter. Screw shall be tightened 1/4 to 1/2 turns more after touched correctly.

○ Panel cutout dimension

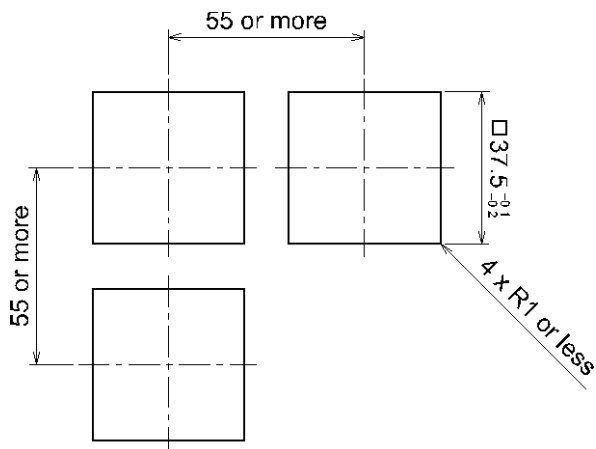

*: Panel thickness 0.5 to 8 mm

Notice when removing to the controller

- The Monitor with the panel mount adapter can be removed from facility after removing two screws as shown in a figure, by making insert the suitable thin card for the hook of both the sides, pull a panel mount adapter to the front, and remove it. If panel mount adapter is drawn forward with hook caught, the adapter and Monitor may be damaged.

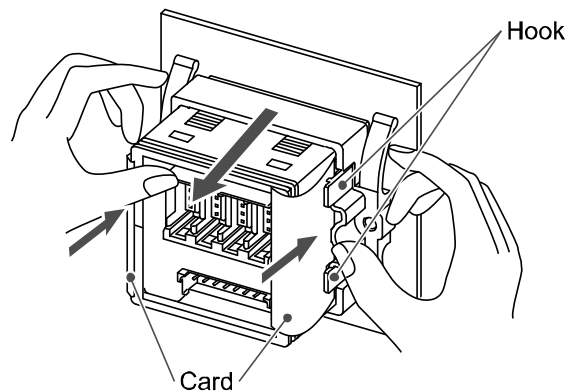

■Wiring

○Wiring connections

- Connections should be made with the power supply turned off.
- Use a separate route for the product wiring and any power or high voltage wiring. Otherwise, malfunction may result due to noise.
- If a commercially available switching power supply is used, be sure to ground the frame ground (FG) terminal. If the switching power supply is connected for use, switching noise will be superimposed and it will not be able to meet the product specifications. In that case, insert a noise filter such as a line noise filter/ferrite between the switching power supplies or change the switching power supply to the series power supply.

○Attaching the connector to the lead wire

- Sensor wire is stripped as shown in the right figure.
(Refer to the table below for correspondence between connector and electrical wire gauge.)

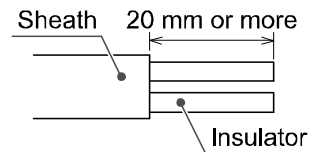

Lead wire table

AWG No.	Conductor size (mm ²)	Overall diameter (mm)	Colour of cover	SMC product No. (1 pc.)
26-24	0.14-0.2	φ0.8 to φ1.0	Red	ZS-28-C
		φ1.0 to φ1.2	Yellow	ZS-28-C-1
		φ1.2 to φ1.6	Orange	ZS-28-C-2
22-20	0.3-0.5	φ1.0 to φ1.2	Green	ZS-28-C-3
		φ1.2 to φ1.6	Blue	ZS-28-C-4
		φ1.6 to φ2.0	Gray	ZS-28-C-5

- Do not cut the insulator.
- The core of the corresponding colour shown in the following table is put into the pin of the number stamped on the connector for sensor connection to the back.

Pin No.	Wire colour
1	Brown (DC+)
2	NC
3	Blue (DC-)
4	Black (IN: 1 to 5 V)

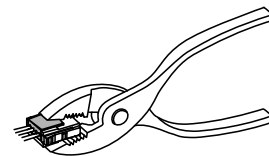
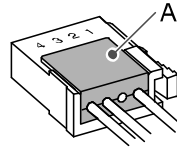

- Check that the above-mentioned preparation work has been performed correctly, and part A shown in the figure is pushed by hand and makes temporary connection.
- Part A centre is pushed straight in using a suitable tool, such as pliers.
- Re-use cannot be performed once it connects the connector for sensor connection completely. When the connection fails or a pin is miswired, please use a new connector for sensor connection.
- When the sensor is not connected correctly, [LLL] will be displayed.
- Cable wire colour is applicable when an SMC sensor with lead wire is used.

○Connector

Connecting/Disconnecting

- When connecting the connector, insert it straight onto the pin and lock the connector into the square groove in the housing until connector clicks.
- When removing the connector, press down the lever with your thumb and pull the connector straight out.

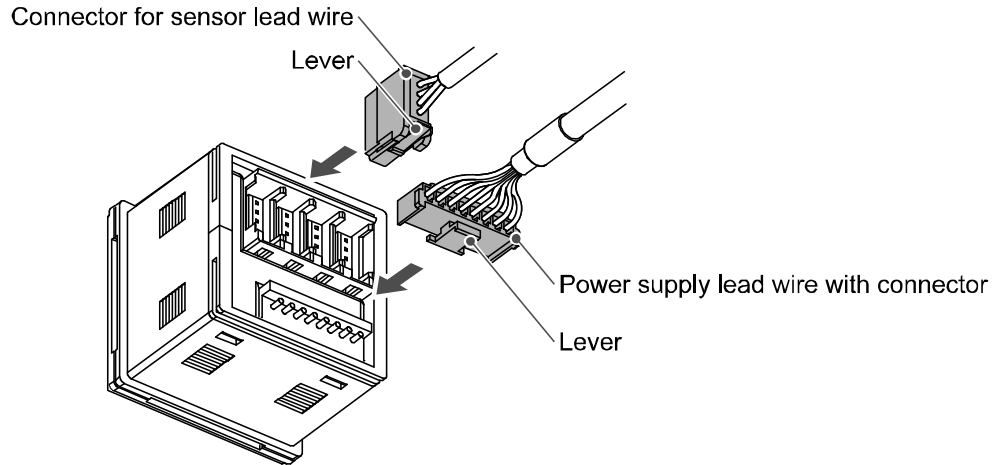

Pin No. of the connector

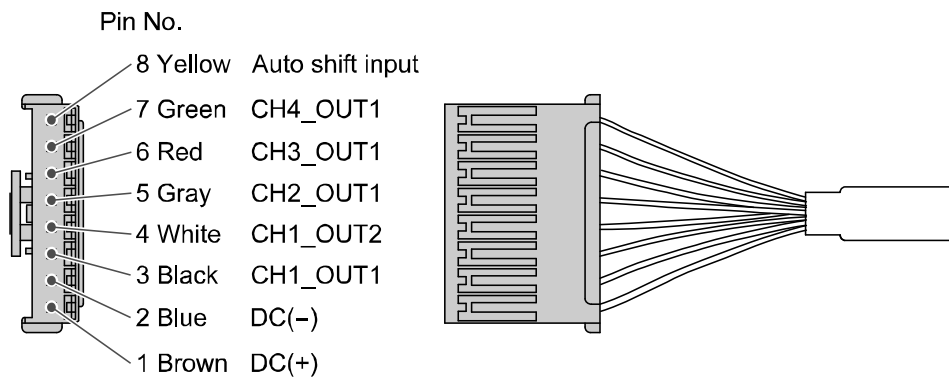

Internal circuit and wiring example

Output specification

When the lead wire with SMC power and output lead wire (Model: ZS-26-L) is used, the colours of wire (Brown, Blue, White, Gray, Red, Green Yellow) will apply as shown on circuit diagram.

PSE200A-(M): NPN open collector 5 outputs + Auto-shift 1 input
 Max. 30 V, 80 mA
 Residual voltage 1.5 V or less

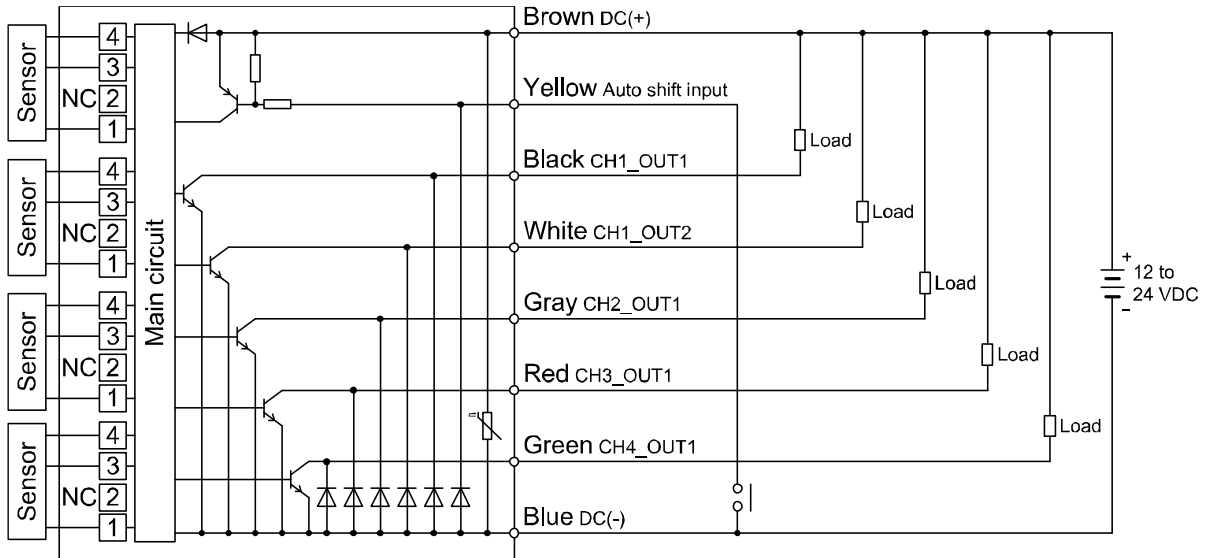

PSE201A-(M): PNP open collector 5 outputs + Auto-shift 1 input
 Max. 80 mA
 Residual voltage 1.5 V or less

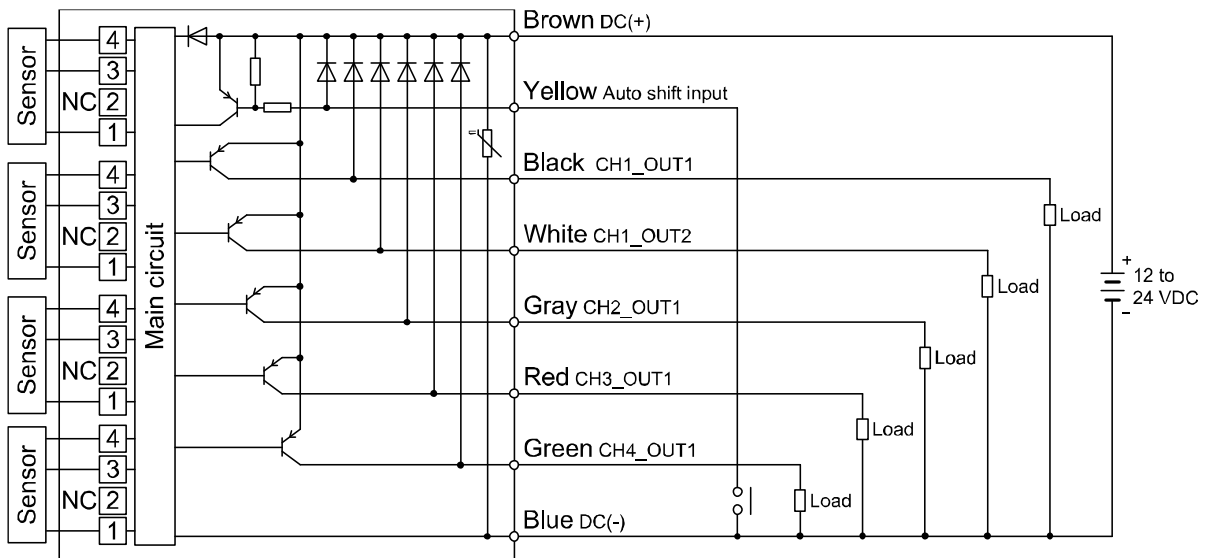

Pressure Setting

Default settings

When the pressure exceeds the set value, the switch will be turned on.

When the pressure falls below the set value by the amount of hysteresis or more, the switch will be turned off.

The default setting is that the output is turned ON at -50.5 kPa when the pressure range of the connected sensor is vacuum.

Perform initial setting by referring to the setting outline (page 20).

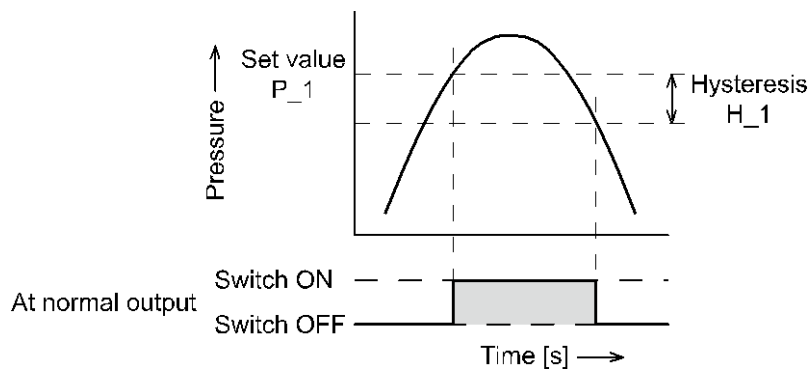

Zero-clear of display

The display is reset to zero when the UP and DOWN buttons are pressed simultaneously for 1 second. For the first operation, perform a zero-clear without pressure at measurement mode.

Zero-clear function ➡ [Page 68](#)

Outline of Settings

Power is supplied



The product code is displayed for approximately 3 sec. after supplying power.
After that, measurement mode is displayed.

*: Within approximately 0.2 second after power-on, the switch starts.



[Initial Setting]

(Function selection mode [F 0]) (Refer to page [22](#))

Set the differential pressure check mode, pressure range, and display unit of the connected sensor.





[Measurement mode]

Detects the pressure after power is supplied, and indicates the display and switch operating status. This is the basic mode; other modes should be selected for set-point changes and other function settings.

Measurement mode screen

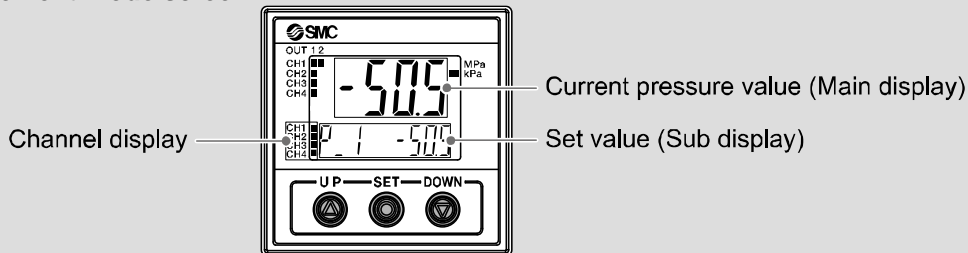

Channel selection

In measurement mode, the channel can be changed by pressing the UP button.

Measurement mode display and setting are set for each channel.

Normal operation mode

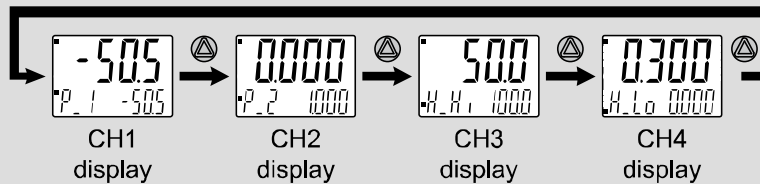

Differential pressure check mode

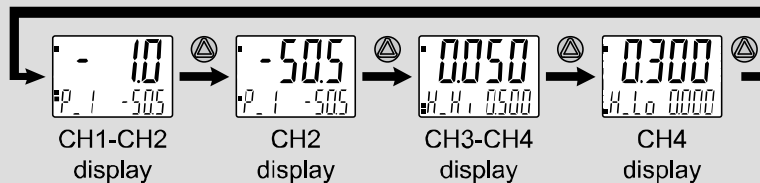

Press the SET button once.



Press the SET button between 1 and 3 sec.



Press the SET button between 3 and 5 sec.



Press the DOWN button once.



[3 step setting mode]

Set either of set value or hysteresis.
(Refer to page 26)

[Simple setting mode]

Select the set value, hysteresis and delay time.
(Refer to page 28)

[Function selection mode]

Change the function settings.
(Refer to page 30)

[Sub display setting]

(Refer to page 50)

[Other Settings]

- Channel scan function
- Zero-clear function
- Key-lock function (Refer to page 67)

*: The outputs will continue to operate during setting.

*: If a button operation is not performed for a certain time during the setting, the display will flash.

(This is to prevent the setting from remaining incomplete if, for instance, an operator were to leave during setting.)

*: 3 step setting mode, simple setting mode and function selection mode settings are reflected each other.

Initial Setting

Set the differential pressure check mode, pressure range, and display unit of the connected sensor.

Measurement mode



Press the UP button to select the channel.
Press the SET button between 3 and 5 sec.

[F0] Displays differential pressure check mode, pressure range and display unit.



Press the SET button.



Move on to the setting of differential pressure check mode.

Differential pressure check mode setting (Setting common for all channels)

Set and display the differential pressure between CH1 - CH2, and CH3 - CH4.

Press the UP button to select the differential pressure check mode.

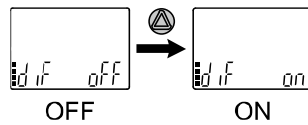
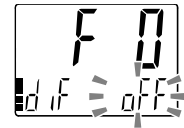

Press the SET button.



Move on to pressure range setting.



Pressure range setting

Press the UP or DOWN button to select pressure range.

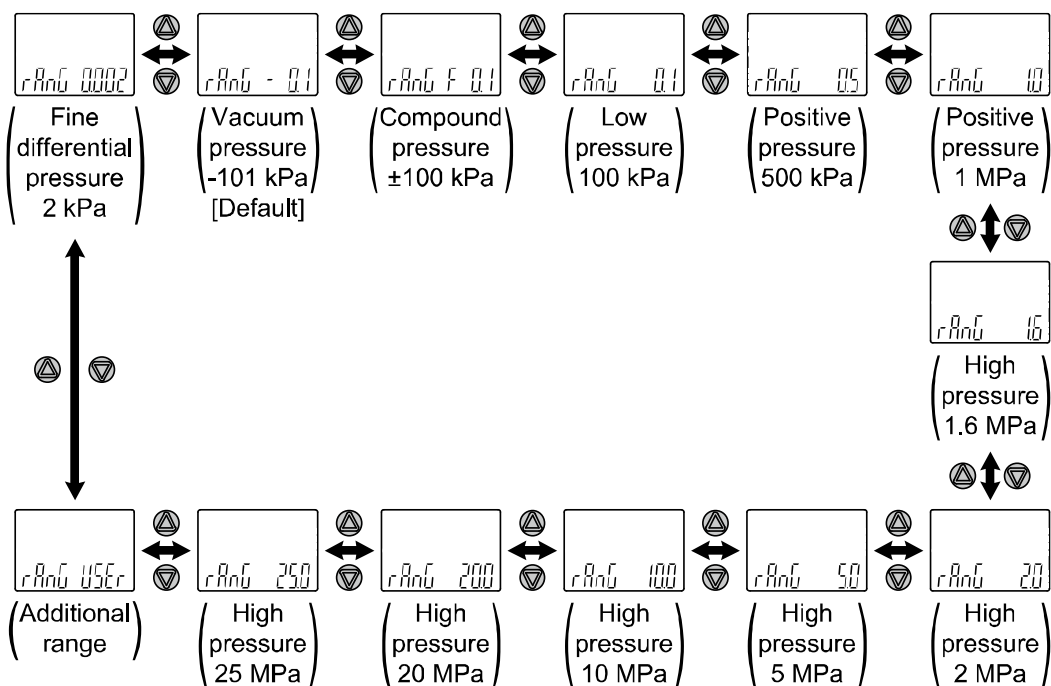

[USER] is selected.
 Press the SET button to move on to the setting of the minimum unit of the additional range.

Additional range minimum unit setting

Press the UP or DOWN button to select the minimum unit.

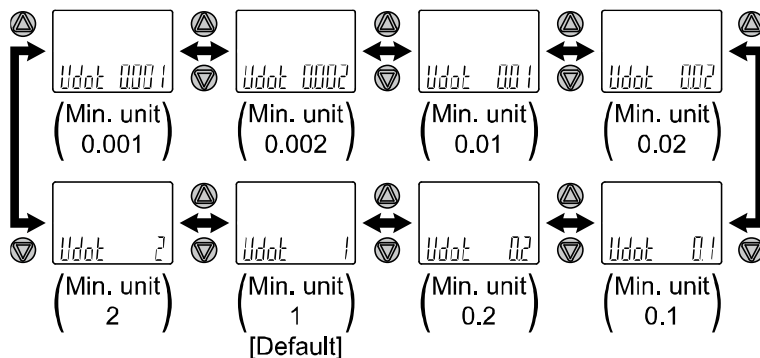

Press the SET button to set.

Move on to the setting of the lower limit of the additional rated range.
 The lower limit of the rated range is the displayed value when the sensor input signal is 0%.

Other than [USER] is selected.
 Press the SET button to move on to display unit setting.

Setting of the lower limit of the additional rated range

Press the UP or DOWN button to change the value.
 Press the button continuously to keep changing the value.
 Set the value that is required to be displayed when the sensor input signal is 0%.
 The setting range is -1500 to 1500 digit.



*: There is unsetting range. (Refer to page 37)

Press the SET button to set.

Move on to the setting of the upper limit of the additional rated range.
 The upper limit of the rated range is the displayed value when the sensor input signal is 100%.

Setting of the upper limit of the additional rated range

Press the UP or DOWN button to change the value.
 Press the button continuously to keep changing the value.
 Set the value that is required to be displayed when the sensor input signal is 100%.
 The setting range is -1500 to 1500 digit.

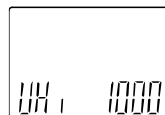

*: There is unsetting range. (Refer to page 37)

Press the SET button to set. Move on to display unit setting.

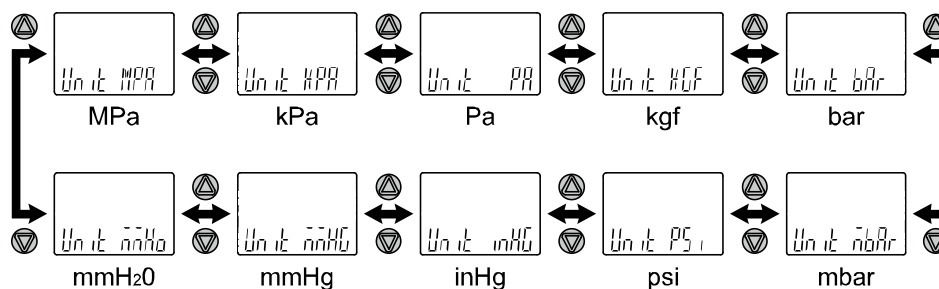
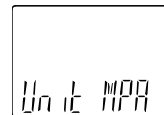

Display unit setting

Press the UP or DOWN button to select the display unit.



*: The unit that can be displayed is different depending on the pressure range. (Refer to page 33)
 (kPa/MPa/Pa can still be selected if the product does not have the units selection function.)
 *: Refer to page 10 for LCD of corresponding unit.

Press the SET button to set. Return to function selection mode.

[F0] Setting of differential pressure check mode, pressure range and display unit is completed

 Press the SET button for 2 second or longer.

Measurement mode
(Initial setting is completed)

Perform the setting with the 3 step setting mode, simple setting mode and function selection mode.

3 Step Setting Mode

3 step setting mode

In this mode, the set values can be input in just 3 steps.

Use this mode if the product is to be used straight away, after changing only the set values.

(The current pressure value is displayed on the main display.)

<Operation>

[3 step setting mode (hysteresis mode)]

In the 3 step setting mode, the set value (P_1 or n_1, P_2 or n_2) and hysteresis (H_1, H_2) can be changed.

After selecting the channel, set the items on the sub display (set value or hysteresis) with the DOWN button.

When changing the set value, follow the operation below. The hysteresis setting can be changed in the same way.

- (1) Press the SET button once when the item to be changed is displayed on the sub display. The set value on the sub display (right) will start flashing.

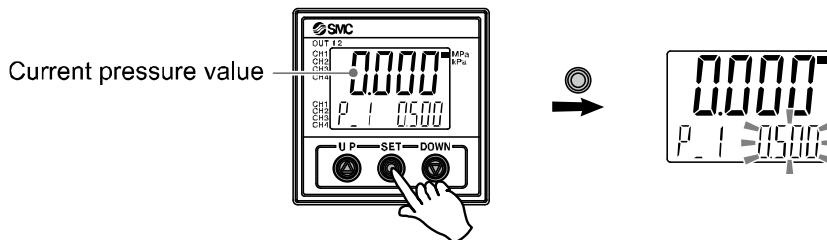

- (2) Press the UP or DOWN button to change the set value. The set value can be increased with UP button and can be reduced with DOWN button.

• Press the UP button once to increase the value by one digit, press and hold to continuously increase.

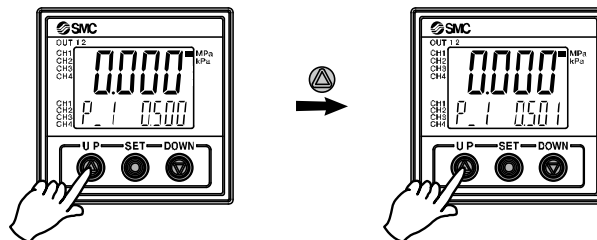

• Press the DOWN button once to reduce the value by one digit, press and hold to continuously reduce.

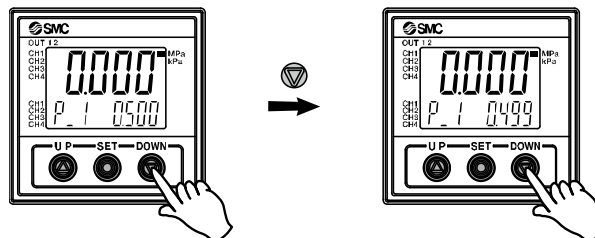

• When the UP and DOWN buttons are pressed and held simultaneously for 1 second or longer, the set value is displayed as [- -], and the set value will be the same as the current pressure value automatically (snap shot function (Refer to page 67)). Afterwards, it is possible to adjust the value by pressing the UP or DOWN button.

- (3) Press the SET button to complete the setting.

The product turns on within a set pressure range (OUT1: from P1L to P1H, OUT2: from P2L to P2H) during window comparator mode. Set P1L/P2L, the lower limit of the switch operation, and P1H/P2H, the upper limit of the switch operation and WH1/WH2 (hysteresis) following the instructions given on page 26. (When reversed output is selected, the sub display (left) shows [n1L]/[n2L] and [n1H]/[n2H].) Please refer to the "List of output modes" on page 40 for the relationship between the set values and operation.

*: Setting of the normal/reverse output switching and hysteresis/window comparator mode switching are performed with the function selection mode [F 1] Setting of OUT1, [F 2] Setting of OUT2.

Simple Setting Mode

<Operation>

[Simple setting mode (hysteresis mode)]

In the simple setting mode, the set value, hysteresis and delay time can be changed while checking the current pressure value (main display).

- (1) After selecting the channel, press the SET button for 1 second or longer, but less than 3 seconds, in measurement mode. [SEt] is displayed on the main display. When the button is released while in the [SEt] display, the current pressure value is displayed on the main display, [P_1] or [n_1] is displayed on the sub display (left), and the set value is displayed on the sub display (right) (Flashing).

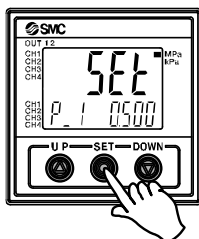

- (2) Change the set value with UP or DOWN button, and press the SET button to set the value. Then, the setting moves to hysteresis setting. (The snap shot function can be used. (Refer to page 67))

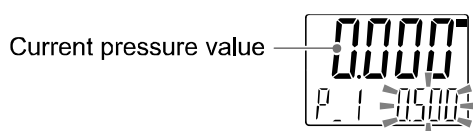

- (3) Change the set value with UP or DOWN button, and press the SET button to set the value. Then, the setting moves to the delay time of the switch output. (The snap shot function can be used. (Refer to page 67))



- (4) The delay time of the switch output can be selected by pressing the UP or DOWN button at the ON and OFF point of the switch output. Delay time setting can prevent the output from chattering. The delay time can be set in the range 0.00 to 60.00 sec. in 0.01 sec. increments.

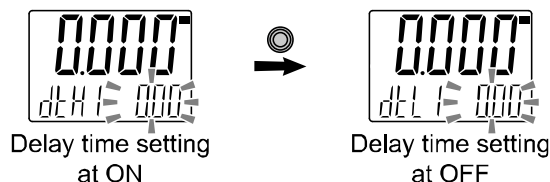

- (5) Press the SET button for 2 seconds or longer to complete the OUT1 setting. [P_2] or [n_2] is displayed on the sub screen (left). Continue with setting the OUT2. Press and hold the SET button for 2 seconds or longer to complete the setting. The product will return to measurement mode.

*1: Selected items (1) to (4) become valid after pressing the SET button.

*2: After enabling the setting by pressing the SET button, it is possible to return to measurement mode by pressing the SET button for 2 seconds or longer.

*3: When the output mode (refer to page 38) is set to error output or switch output OFF, the simple setting mode cannot be used.

In the window comparator mode, set P1L/P2L, the lower limit of the switch operation, and P1H/P2H, the upper limit of the switch operation, WH1/WH2 (hysteresis) and dt1/dt2 (delay time) following the instructions given on page 28.

(When reversed output is selected, the sub display (left) shows [n1L]/[n2L] and [n1H]/[n2H].)

Please refer to the "List of output modes" on page 40 for the relationship between the set values and operation.

Function Selection Mode

■ Function selection mode

After selecting the channel, in measurement mode, press the S button for 3 seconds or longer (but less than 5 seconds), to display [F 0].

Select to display the function to be changed [F□□]. Press and hold the SET button for 2 seconds or longer in function selection mode to return to measurement mode.

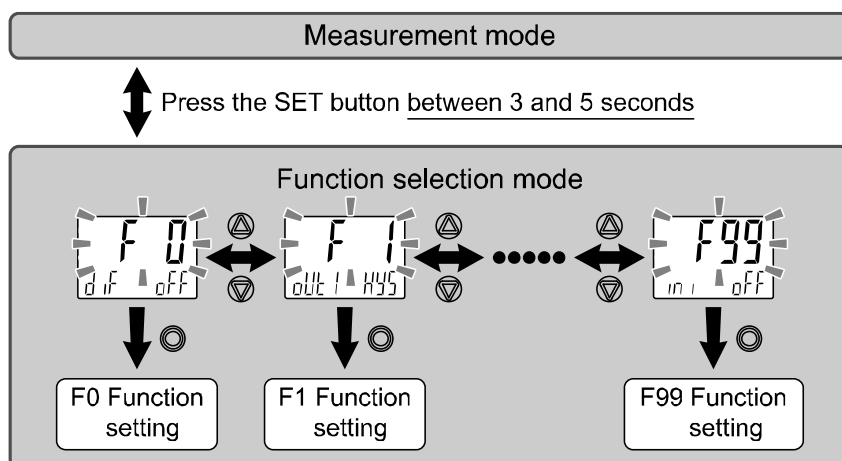

*: Some products do not have all the functions. If no function is available or selected due to configuration of other functions, [- - -] is displayed on the sub display (right).

*: All channel indicators turn on for the setting which is common for all channels.

■ Default setting

The default setting is as follows.

If no problem is caused by this setting, keep these settings.

To change a setting, enter function selection mode.

- [F 0] Differential pressure check mode, pressure range and display unit ➡ Page 32

Item	Default setting
Differential pressure check mode	OFF
Connected sensor range	Vacuum pressure
Display units	Units specification ["Nil" or M]: [kPa]

- [F 1] Setting of OUT1 ➡ Page 38

Item	Explanation	Default setting
Output mode	Either hysteresis mode, window comparator mode, error output or switch output OFF can be selected.	Hysteresis mode
Reversed output	Selects which type of switch output is used, normal or reversed.	Normal output
Pressure setting	Sets the ON and OFF point of the switch output.	-50.5 kPa
Hysteresis	Appropriate setting of the hysteresis will prevent the switch output from chattering.	5.1 kPa
Delay time	Delay time of the switch output can be selected.	0.00 sec.
Display colour	Select the display colour.	Output ON : Green Output OFF: Red (Linked to OUT1)

●[F 2] Setting of OUT2 ➡ Page 41

Item	Explanation	Default setting
Output mode	Either hysteresis mode, window comparator mode, error output or switch output OFF can be selected.	Hysteresis mode
Reversed output	Selects which type of switch output is used, normal or reversed.	Normal output
Pressure setting	Sets the ON and OFF point of the switch output.	-50.5 kPa
Hysteresis	Appropriate setting of the hysteresis will prevent the switch output from chattering.	5.1 kPa
Delay time	Delay time of the switch output can be selected.	0.00 sec.
Display colour	Select the display colour.	Output ON : Green Output OFF: Red (Linked to OUT1)

●Other parameter settings

Item	Page	Default setting
[F 3] Digital filter setting	Page 43	0.00 sec.
[F 4] Auto-preset function	Page 44	Not used
[F 5] Auto-shift setting	Page 46	OFF
[F 6] Fine adjustment of display value	Page 48	0.0%
[F10] Sub display setting	Page 49	std (Standard)
[F11] Display resolution setting	Page 55	1000-split
[F14] Zero cut-off setting	Page 56	0.0%
[F80] Power saving mode	Page 57	OFF
[F81] Security code	Page 58	OFF
[F90] Setting of all functions	Page 60	OFF
[F95] Channel to channel copy function setting	Page 62	OFF
[F96] Sensor input/External input signal status display	Page 63	No configurable items
[F98] Output check	Page 64	N/A (normal output)
[F99] Reset to default settings	Page 66	OFF

■[F 0] Differential pressure check mode, pressure range and display unit

<Differential pressure check mode>

Selected channel is CH1: Differential pressure between CH1-CH2 can be set and displayed.

Selected channel is CH2: Measurement value of CH2 (normal operation) can be set and displayed.

Selected channel is CH3: Differential pressure between CH3-CH4 can be set and displayed.

Selected channel is CH4: Measurement value of CH4 (normal operation) can be set and displayed.

Selected channel	CH1	CH2	CH3	CH4
Normal operation mode	CH1	CH2	CH3	CH4
Differential pressure check mode	CH1-CH2	CH2	CH3-CH4	CH4
Output	CH1_OUT1 CH1_OUT2	CH2_OUT1	CH3_OUT1	CH4_OUT1
Channel display	CH1/CH2 ON	CH2 ON	CH3/CH4 ON	CH4 ON

*: When differential pressure check mode is selected, the range of the sensor connected to CH1-CH2 and CH3-CH4 should be the same.

*: Initial range setting [rAnG] and unit setting [Unit] and digital filter [Fil] for CH2 and CH4 are not selectable. The operations are based on the setting for CH1 and CH3.

*: Set pressure range during differential pressure check mode is the same as the normal operation mode.

*: During differential pressure check mode, measurement error "[- -]" is displayed when the applied pressure error ([HHH], [LLL]) occurs in one or both selected channel(s).

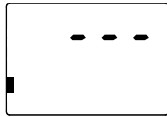

Refer to the connection in the table below for connecting the sensor for differential pressure check mode. Set range can be effectively used by connections below.

Range setting	Selected channel			
	CH1	CH2	CH3	CH4
Compound pressure	Hi/Lo side	Lo/Hi side	Hi/Lo side	Lo/Hi side
Vacuum pressure	Lo side	Hi side	Lo side	Hi side
Low pressure/ Positive pressure/High pressure	Hi side	Lo side	Hi side	Lo side

*: Hi: High pressure side, Lo: Low pressure side.

Pressure range setting

Pressure range that matches with the connected sensor can be selected. In addition, the required range can be set and displayed. (Additional range)

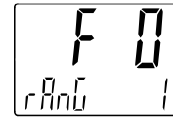

•Relation between the sensor input and pressure display

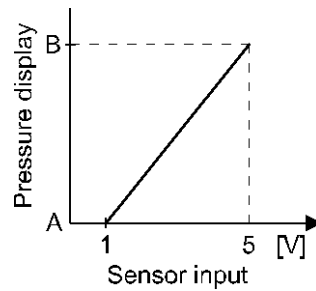

Pressure range	Set value	A	B
Fine differential pressure	0.002	0 kPa	2 kPa
Vacuum pressure	- 0.1	0 kPa	-101 kPa
Compound pressure	F0.1	-100 kPa	100 kPa
Low pressure	0.1	0 kPa	100 kPa
Positive pressure	0.5	0 kPa	500 kPa
	1.0	0 MPa	1 MPa
	1.6	0 MPa	1.6 MPa
High pressure	2.0	0 MPa	2 MPa
	5.0	0 MPa	5 MPa
	10.0	0 MPa	10 MPa
	20.0	0 MPa	20 MPa
	25.0	0 MPa	25 MPa
Additional range	USEr	Input value (setting)	Input value (setting)

•Available display unit and minimum set value

Pressure range	Rated pressure	Display	MPa	kPa	Pa	kgf/cm ²	bar	mbar	psi	inHg	mmHg	mmH ₂ O
Fine differential pressure	2 kPa	0.002	-	0.001	1	-	-	0.01	0.001	-	-	0.1
Vacuum pressure	-101 kPa	- 0.1	0.001	0.1	-	0.001	0.001	-	0.01	0.1	1	-
Compound pressure	±100 kPa	F0.1	0.001	0.1	-	0.001	0.001	-	0.02	0.1	1	-
Low pressure	100 kPa	0.1	0.001	0.1	-	0.001	0.001	-	0.01	-	-	-
Positive pressure	500 kPa	0.5	0.001	1	-	0.01	0.01	-	0.1	-	-	-
	1 MPa	1.0	0.001	1	-	0.01	0.01	-	0.1	-	-	-
	1.6 MPa											
High pressure	2 MPa	2.0	0.001	1	-	0.01	0.01	-	0.2	-	-	-
	5 MPa	5.0	0.01	-	-	0.1	0.1	-	1	-	-	-
	10 MPa	10.0	0.01	-	-	0.1	0.1	-	1	-	-	-
	20 MPa	20.0	0.01	-	-	0.1	0.1	-	2	-	-	-
	25 MPa	25.0	0.02	-	-	0.2	0.2	-	2	-	-	-
Additional range x 1	USEr	It varies depending on the minimum unit setting of the additional range. (All pressure units are selectable)										

<Operation>

Press the UP or DOWN button in function selection mode to display [F 0].

Press the SET button.



Move on to the setting of differential pressure check mode.

Differential pressure check mode setting (Setting common for all channels)

Set and display the differential pressure between CH1 - CH2, and CH3 - CH4.

Press the UP button to select the differential pressure check mode.

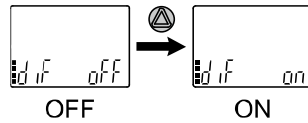

Press the SET button.



Move on to pressure range setting.

*: When differential pressure check mode is switched, peak/ bottom value, zero clear value and auto-shift corrected value are cleared.



Pressure range setting

Press the UP or DOWN button to select pressure range.

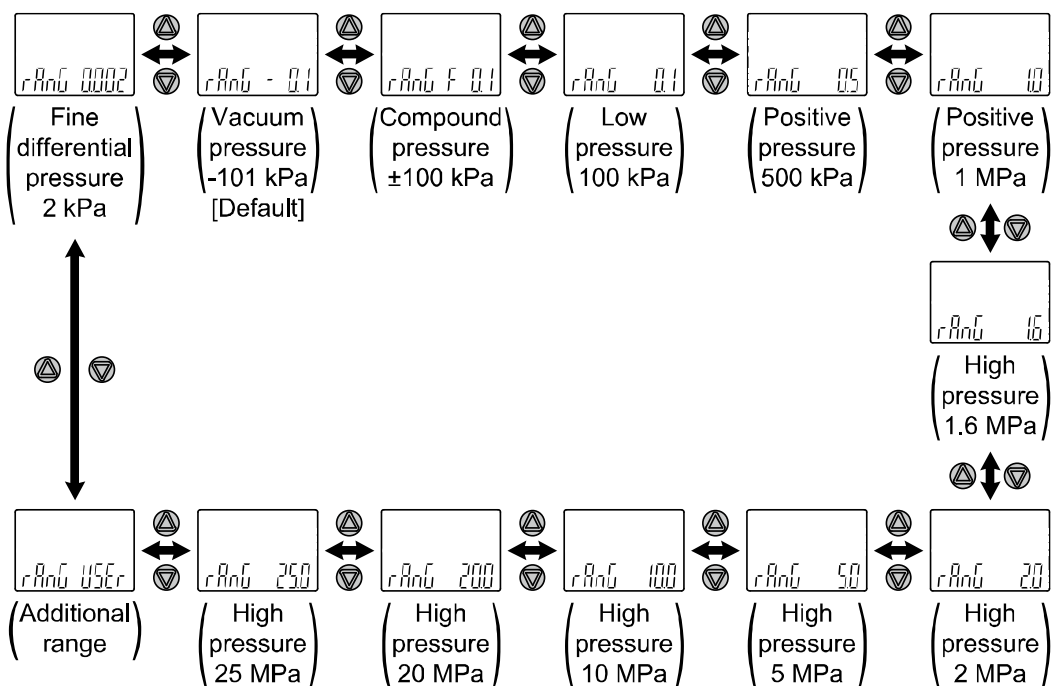

[USER] is selected.
 Press the SET button to move on to the setting of the minimum unit of the additional range.

Additional range minimum unit setting

Press the UP or DOWN button to select the minimum unit.

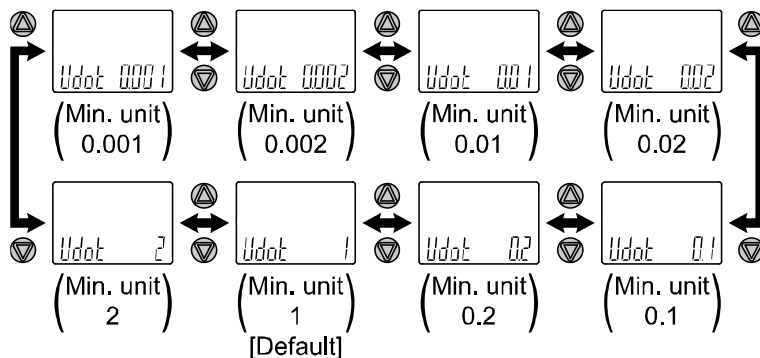

Press the SET button to set.

Move on to the setting of the lower limit of the additional rated range.
 The lower limit of the rated range is the displayed value when the sensor input signal is 0%.

Other than [USER] is selected.
 Press the SET button to move on to display unit setting.

Setting of the lower limit of the additional rated range

Press the UP or DOWN button to change the value.
 Press the button continuously to keep changing the value.
 Set the value that is required to be displayed when the sensor input signal is 0%.
 The setting range is -1500 to 1500 digit.



*: There is unsetting range. (Refer to page 37)

Press the SET button to set.

Move on to the setting of the upper limit of the additional rated range.
 The upper limit of the rated range is the displayed value when the sensor input signal is 100%.

Setting of the upper limit of the additional rated range

Press the UP or DOWN button to change the value.
 Press the button continuously to keep changing the value.
 Set the value that is required to be displayed when the sensor input signal is 100%.
 The setting range is -1500 to 1500 digit.

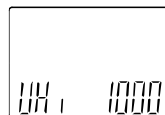

*: There is unsetting range. (Refer to page 37)

Press the SET button to set. Move on to display unit setting.

Display unit setting

Press the UP or DOWN button to select the display unit.

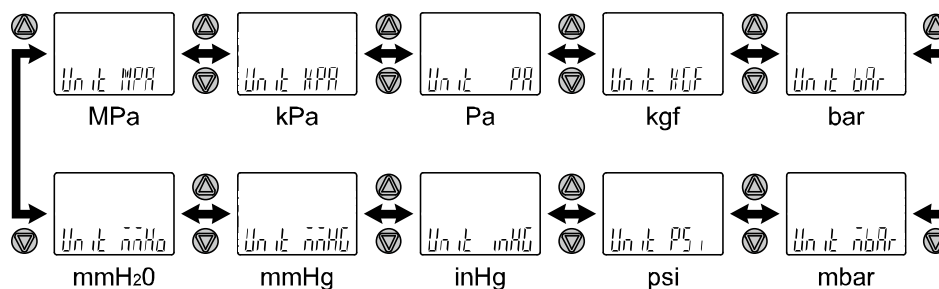
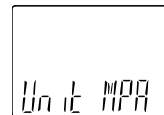

*: The unit that can be displayed is different depending on the pressure range. (Refer to page 33)
 (kPa/MPa/Pa can still be selected if the product does not have the units selection function.)
 *: Refer to page 10 for LCD of corresponding unit.

Press the SET button to set. Return to function selection mode.

[F0] Setting of differential pressure check mode, pressure range and display unit is completed

●Settable range of the additional range

<Minimum settable unit [Udot]: "0.001", "0.01", "0.1", "1">

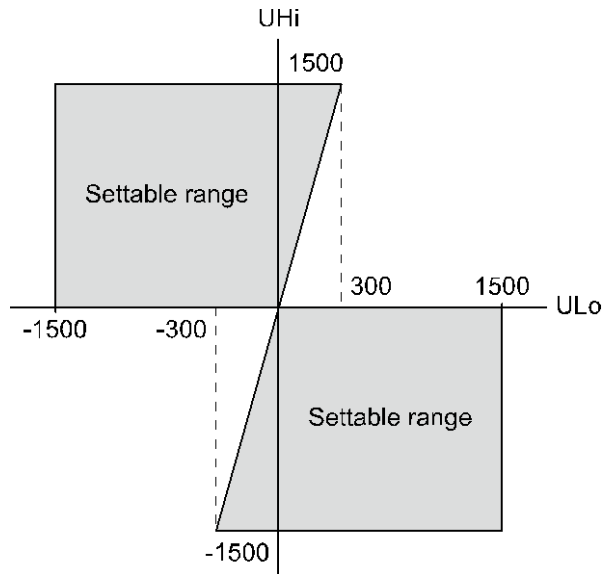

<Minimum settable unit [Udot]: "0.002", "0.02", "0.2", "2">

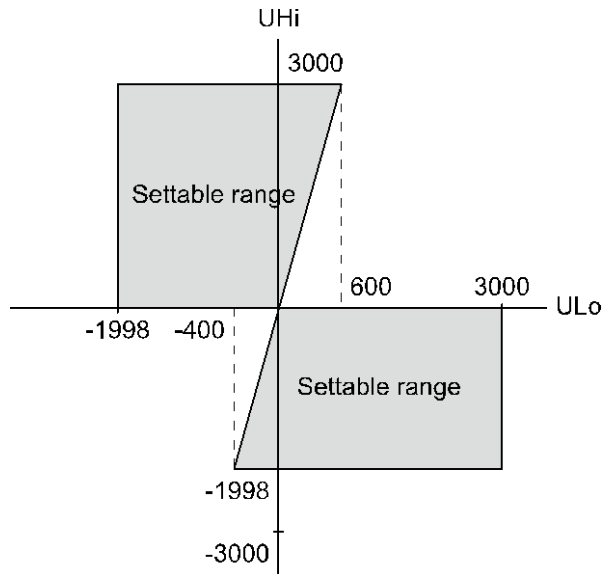

*: When pressure range, minimum unit/lower limit/upper limit of additional range is changed, setting below will be initialized and cleared. These items must be set again.

- Display unit settings
- Pressure Setting
- Hysteresis setting
- Peak/Bottom value
- Zero-clear value
- Auto-shift correction value

■[F 1] Setting of OUT1

Set the output mode of OUT1.

Output turns on when the pressure is greater than the set value. The default setting is to turn on the product when the pressure reaches the center of the atmospheric pressure and upper limit of the rated pressure range.

Output ON lights in green and output OFF lights in red as default setting.

Please refer to the "List of output modes" on page 40 for the relationship between the set items and operation.

<Operation>

Press the UP or DOWN button in function selection mode to display [F 1].

Press the SET button. ↓ Move on to output mode setting.

Output mode setting

Press the UP or DOWN button to select the required output mode.



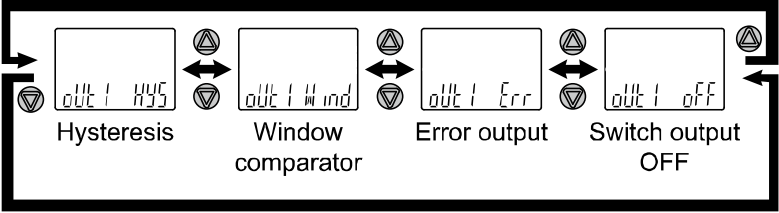

Press the SET button to set. ↓ Move on to reversed output setting.

Reversed output setting

Press the UP or DOWN button to select the reversed output.



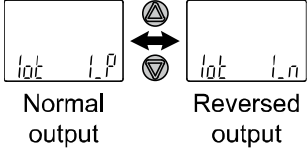

Press the SET button to set. ↓ Move on to pressure setting.

Pressure setting

Set the pressure based on the setting method on page 26.

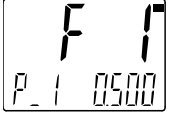

Hysteresis mode: [P_1]
 Window comparator mode: [P1L] [P1H]
 "P" is changed to "n" as [P_1] → [n_1] when reversed output is selected.
 The snap shot function can be used.
 (Refer to page 67)

Press the SET button to set. ↓ Move on to hysteresis setting.

[Err] Error output is selected.

Press the SET button to move on to display colour setting.

[OFF] Switch output OFF is selected.
 Press the SET button to move on to display colour setting.

Hysteresis setting

Set the pressure referring to the setting method on page 26.

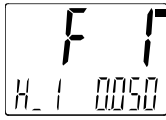

Hysteresis mode: [H_1]
Window comparator mode: [WH1]
The snap shot function can be used.
(Refer to page 67)

Press the SET button to set. Move on to delay time setting.

Delay time setting

Set the delay time referring to the setting method on page 28.

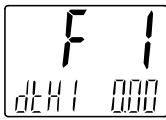

Delay time setting at ON

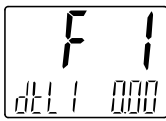

Delay time setting at OFF

Press the SET button to set. Move on to display colour setting.

Display colour setting

Press the UP or DOWN button to select the display colour.

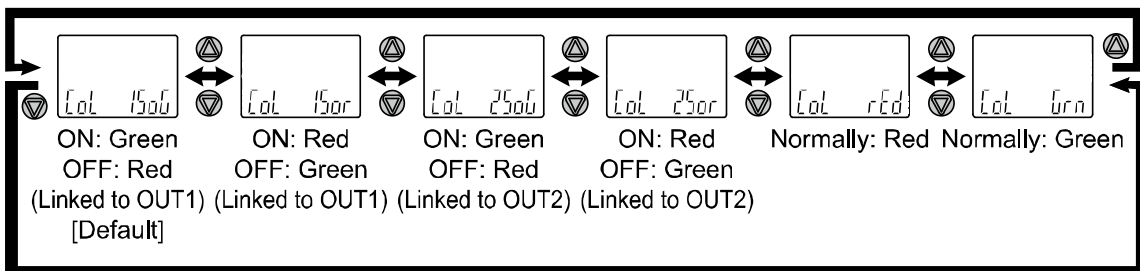
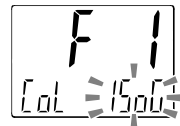

Press the SET button to set. Return to function selection mode.

[F 1] Setting of OUT1 completed

*1: Selected item becomes valid after pressing the SET button.

*2: After enabling the setting by pressing the SET button, it is possible to return to the measurement mode by keeping pressing the SET button for 2 seconds or longer.

•List of output modes

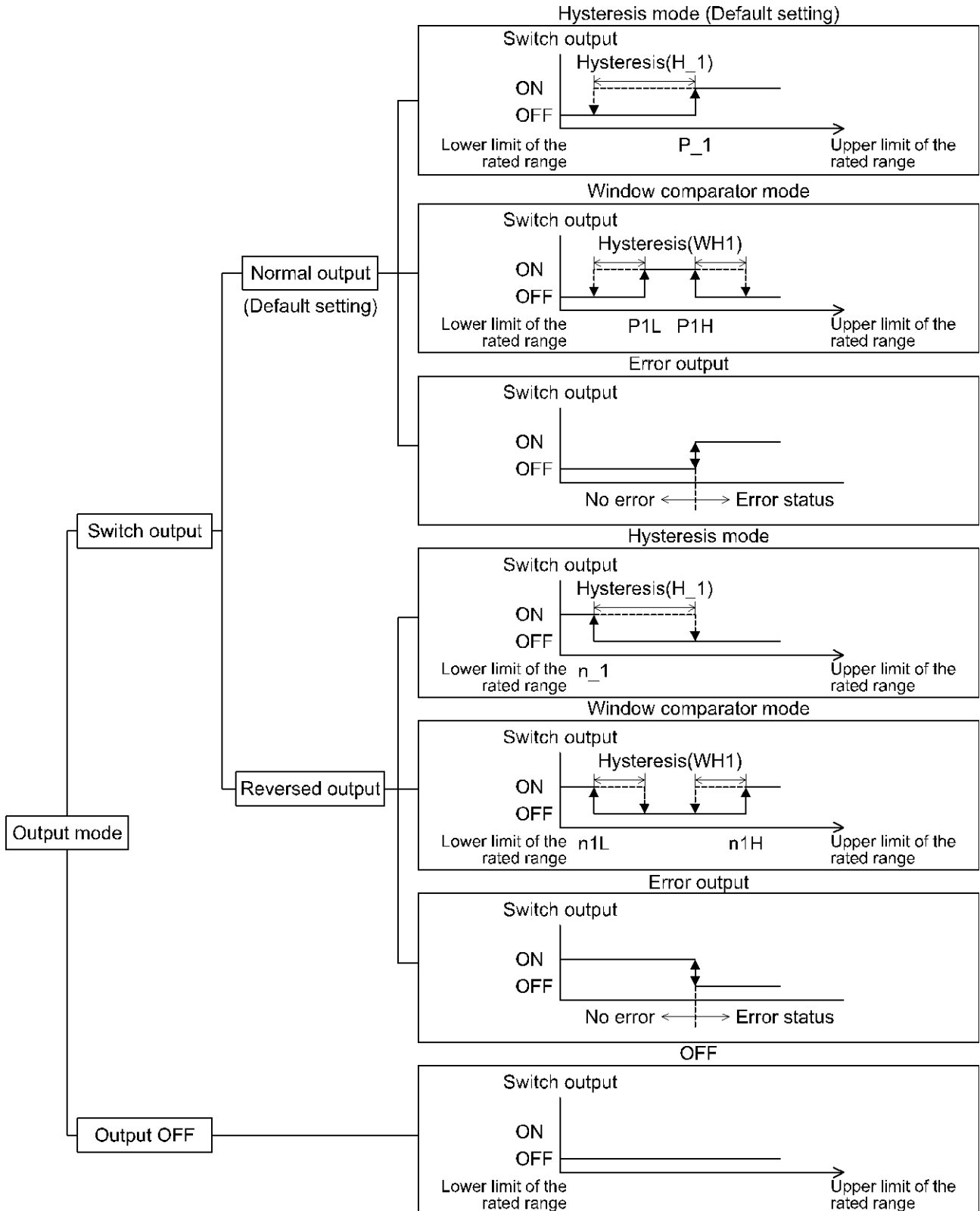

If the point at which the switch output changes is outside of the set pressure range due to the selection of normal or reversed output, the hysteresis value is automatically adjusted.

*: The figure above shows an operation at OUT 1. For OUT2, all "1" in the figure will be changed to "2". (e.g) $P_1 \rightarrow P_2$

■[F 2] Setting of OUT2

Set the output mode of OUT2.

Output turns on when the pressure is greater than the set value. The default setting is to turn on the product when the pressure reaches the center of the atmospheric pressure and upper limit of the rated pressure range.

Please refer to the "List of output modes" on page 40 for the relationship between the set items and operation.

<Operation>

Press the UP or DOWN button in function selection mode to display [F 2].

Press the SET button. ↓ Move on to output mode setting.

Output mode setting

Press the UP or DOWN button to select the required output mode.



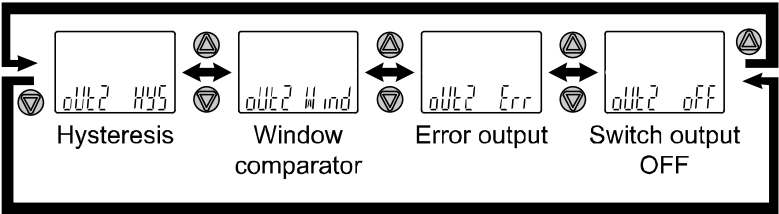

Press the SET button to set. ↓ Move on to reversed output setting.

Reversed output setting

Press the UP or DOWN button to select the reversed output.

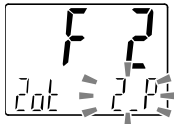

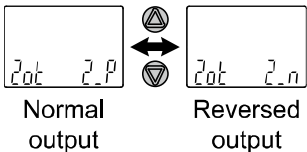

Press the SET button to set. ↓ Move on to pressure setting.

Pressure setting

Set the pressure based on the setting method on page 26.

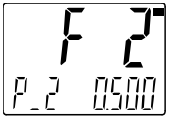

Hysteresis mode: [P_1]
 Window comparator mode: [P1L] [P1H]
 "P" is changed to "n" as [P_1] → [n_1] when reversed output is selected.
 The snap shot function can be used.
 (Refer to page 67)

Press the SET button to set. ↓ Move on to hysteresis setting.

[Err] Error output is selected.

Press the SET button to move on to display colour setting.

[OFF] Switch output OFF is selected.
 Press the SET button to move on to display colour setting.

Hysteresis setting

Set the pressure referring to the setting method on page 26.



Hysteresis mode: [H_1]
Window comparator mode: [WH1]
The snap shot function can be used.
(Refer to page 67)

Press the SET button to set. Move on to delay time setting.

Delay time setting

Set the delay time referring to the setting method on page 28.



Delay time setting at ON



Delay time setting at OFF

Press the SET button to set. Move on to display colour setting.

Display colour setting (common setting for [F 1])

Press the UP or DOWN button to select the display colour.

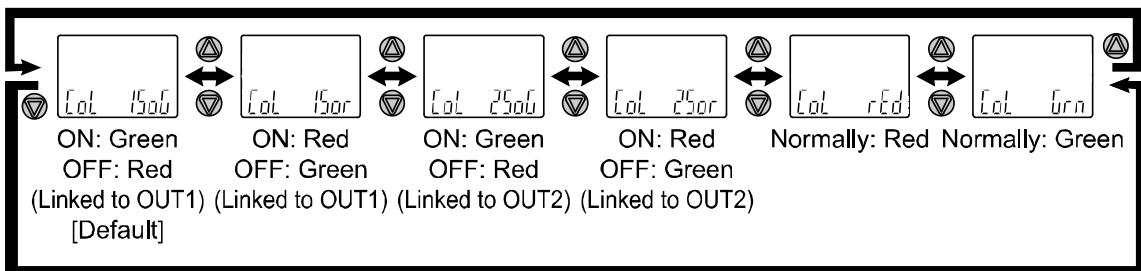

Press the SET button to set. Return to function selection mode.

[F 2] Setting of OUT2 completed

*1: Selected item becomes valid after pressing the SET button.

*2: After enabling the setting by pressing the SET button, it is possible to return to the measurement mode by keeping pressing the SET button for 2 seconds or longer.

■[F 3] Digital filter setting

The Digital filter can be selected to filter the pressure measurement.
Output chattering or flicker in the measurement mode display can be reduced by setting the digital filter.

<Operation>

Press the UP or DOWN button in function selection mode to display [F 3].

Press the SET button. ↓ Move on to digital filter setting.

Digital filter setting

Press the UP or DOWN button to select the digital filter.
The digital filter can be set in the range 0.00 to 30.0 [sec.] in increments of 0.01 [sec.].

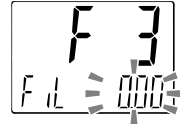

Press the SET button to set. ↓ Return to function selection mode.

[F 3] Digital filter setting completed

*1: Each set value is a guideline for 90% response time.

*2: Both the switch output and pressure display are affected. When only switch output needs to be affected, select the delay time setting. (page 28, 39 and 42)

■[F 4] Auto-preset function

This function will automatically calculate and set the optimum pressure based on the actual operating condition, when hysteresis mode has been selected.

<Operation>

Press the UP or DOWN button in function selection mode to display [F 4].

Press the SET button. ↓ Move on to Auto-preset function.

Auto-preset function

Press the UP or DOWN button to select the auto-preset function.

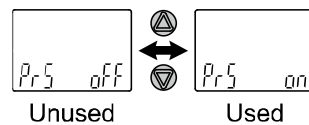
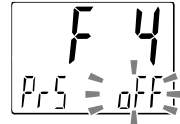

Press the SET button to set. ↓ Return to function selection mode.

[F 4] Auto-preset function completed

Press the SET button in measurement mode to perform the pressure setting.
Then, press the SET button again to change the pressure while the display is flashing.
(Refer to page 45 for details.)

●Auto-preset

When auto-preset is selected in function selection mode, the set value can be calculated and memorized from the measured pressure. Repeating the suction and release of the workpiece to be set for several times will automatically optimize the set value.

(1) Selection of auto-preset OUT1 mode

Press the SET button in measurement mode to display [AP1 rEdY].
 (If setting of OUT1 is not necessary, select [AP1 rEdY], and then press the UP and DOWN buttons simultaneously for 1 second or longer.
 The display will move to (4) Selection of auto-preset OUT2 mode.)



Auto-preset is ready

(2) Preparation of equipment for OUT1

Prepare the equipment for which the pressure of OUT1 is to be set.

(3) Setting of auto-preset for OUT1

Press the SET button, [AP1 rUn] will be displayed.
 Measurement starts. Operate the device to change the pressure.
 (If the UP and DOWN buttons are pressed simultaneously for 1 second or longer while [AP1 rUn] is displayed, measurement will be stopped and (4) Selection of auto-preset OUT2 mode will return.)



Auto-preset is being set

(4) Selection of auto-preset OUT2 mode

Press the SET button in measurement mode to display [AP2 rEdY].
 (If setting of OUT2 is not necessary, select [AP2 rEdY], and then press the UP and DOWN buttons simultaneously for 1 second or longer.
 The display will move to measurement mode.)

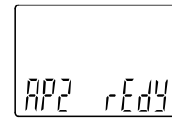

Auto-preset is ready

(5) Preparation of equipment for OUT2

Prepare the equipment for which the pressure of OUT2 is to be set.

(6) Setting of auto-preset for OUT2

Press the SET button, [AP2 rUn] will be displayed.
 Measurement starts. Operate the device to change the pressure.
 (If the UP and DOWN buttons are pressed simultaneously for 1 second or longer while [AP2 rUn] is displayed, measurement will be stopped and measurement mode will return.)



Auto-preset is being set

(7) Complete setup.

Press the SET button to complete auto-preset mode. Then, measurement mode returns.

The settings in auto-preset will be as follows.

•Normal output

$$P_1(P_2)=A-(A-B)/4$$

$$H_1(H_2)=|(A-B)/2|$$

•Reversed output

$$n_1(n_2)=B+(A-B)/4$$

$$H_1(H_2)=|(A-B)/2|$$

A = Maximum pressure

B = Minimum pressure

If setting is not necessary press the UP and DOWN buttons simultaneously for 1 second or longer.

■[F 5] Auto-shift setting

Auto-shift function can be selected.

Auto-shift: The display indicates the change of relative flow from the reference value.

Auto-shift zero: The display is set to zero when the signal is input, and therefore the display indicates the change of relative flow from the reference value.

<Operation>

Press the UP or DOWN button in function selection mode to display [F 5].

Press the SET button. ↓ Move on to the setting of auto-shift.

Auto shift setting

Press the UP or DOWN button to select auto-shift mode.

Press the SET button to set. ↓ Move on to setting of effective output.

Setting of effective output

Press the UP or DOWN button to select the effective output.

Press the SET button to set. ↓ Return to function selection mode.

[F5] Auto-shift setting is completed

Conditions and explanations for auto-shift function

- Maintain a constant pressure for 5 ms or longer from the end of the auto-shift input signal.
- The sub screen displays "ASin ooo" for approximately 1 second during auto-shift input, and the pressure value is stored as the corrective value "C_5".
- With the corrected value stored, the set value is compensated.
- When the set value is corrected, the switch output will operate in accordance with the delay time, within 5 ms after the auto-shift input.
- If the measurement pressure during the auto-shift input operation exceeds the set pressure range, the corrected value will not be stored, but "ASin o.r" will be displayed on the sub screen for approximately 1 second.
- If the measurement value during auto-shift input is within the set pressure range, and the set value corrected by auto-shift (including hysteresis) exceeds the set pressure range, the set value will be corrected to the upper or lower value (whichever is closer).
(The correction is performed when the auto-shift input is applied at the pressure beyond the set pressure range. If the auto-shift input is applied again at the pressure within the set pressure range, the correction is released and the product operates according to the set value).
- The corrected value memorized on "C_5" can be displayed on the sub screen in measurement mode.
(Refer to "Sub display" on page 50.)
- The corrected value [C_5] after auto-shift input will disappear when the power is turned off, and will reset to zero (initial value) when the power is returned.

Using the auto-shift input, the acceptable set range is as follows:

Range setting	Acceptable set range
0 to 2 kPa	-2.30 to 2.300 kPa
0 to -101 kPa	115.0 to -115.0 kPa
-100 to 100 kPa	-210 to 210.0 kPa
0 to 100 kPa	-115.0 to 115.0 kPa
0 to 500 kPa	-575 to 575 kPa
0 to 1 MPa	-1.155 to 1.155 MPa
0 to 1.6 MPa	-1.785 to 1.785 MPa
0 to 2 MPa	-2.20 to 2.205 MPa
0 to 5 MPa	-5.50 to 5.50 MPa
0 to 10 MPa	-11.00 to 11.00 MPa
0 to 1.6 MPa	-1.785 to 1.785 MPa
0 to 20 MPa	-22.0 to 22.00 MPa
0 to 25 MPa	-27.5 to 27.50 MPa

■[F 6] Fine adjustment of display value

This function is to manually perform a fine adjustment of the displayed pressure value.
Pressure can be adjusted in the following range of $\pm 5\%$ R.D.

<Operation>

Press the UP or DOWN button in function selection mode to display [F 6].

Press the SET button. ↓ Move on to fine adjustment of display value.

Fine adjustment of display value

Press the UP or DOWN button to change adjustment rate.

When adjustment rate is changed, the pressure value after the adjustment will be displayed on the main screen.

Pressure after adjustment



Adjustment rate

Press the SET button to set. ↓ Return to function selection mode.

[F 6] Fine adjustment of display value completed

■[F10] Sub display setting

Change the display style of the sub display.
Detailed contents are shown in the pages from 50.

<Operation>

Press the UP or DOWN button in function selection mode to display [F10].

Press the SET button. ↓ Move on to sub display setting.

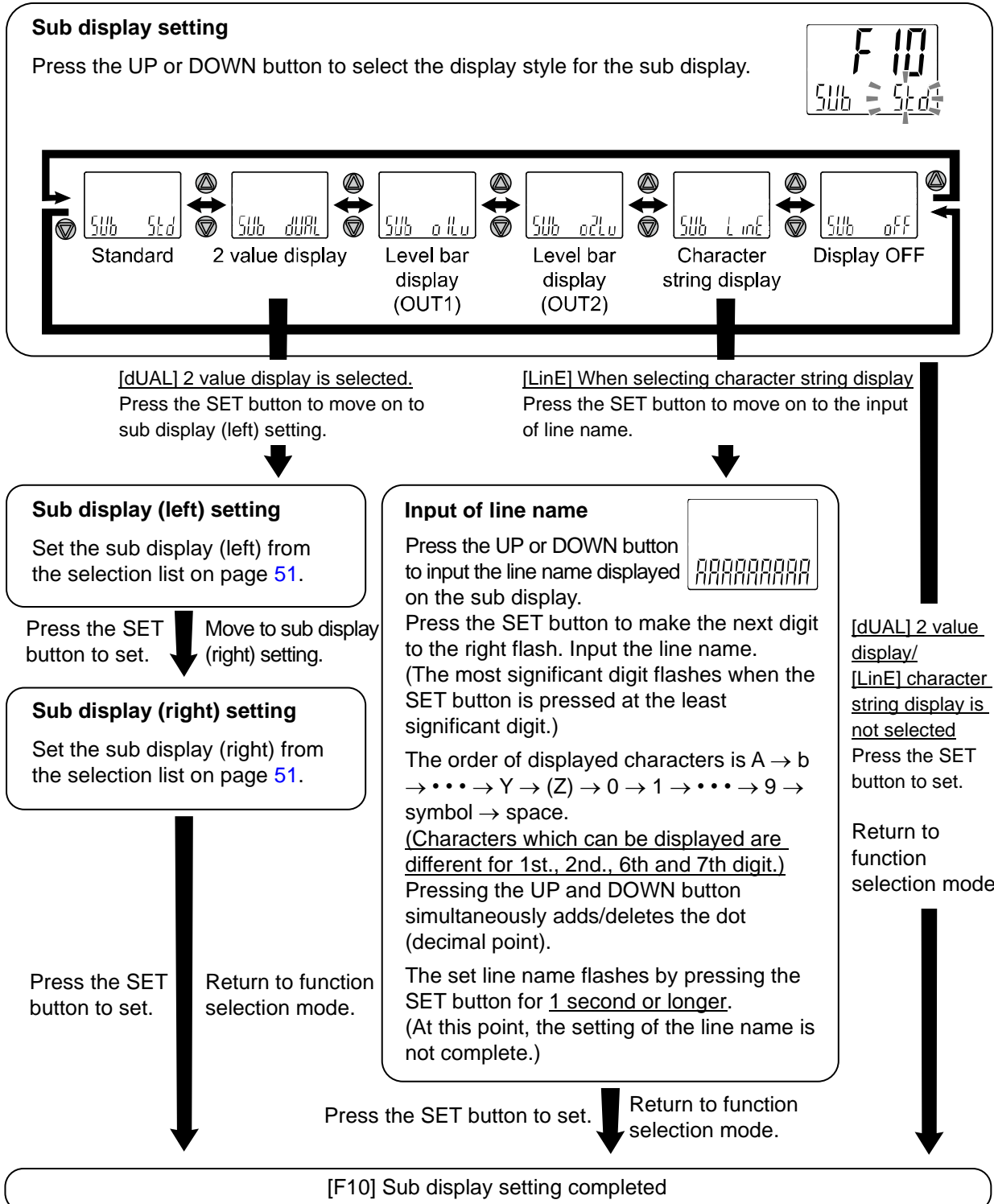

<Sub display>

•Standard

The Standard display function displays the items and values on the sub display.

The displayed item varies depending on the setting of the output mode. Select the displayed items by pressing the DOWN button in measurement mode.

(Hysteresis mode, error output, switch output off)

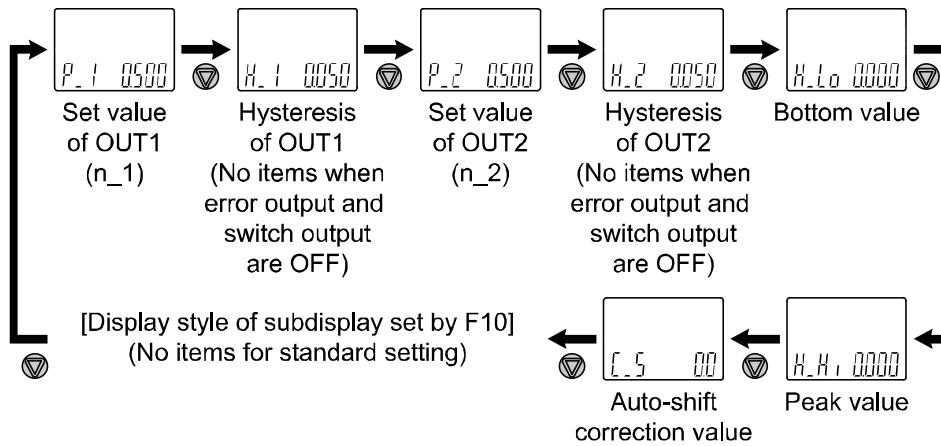

(Window comparator mode)

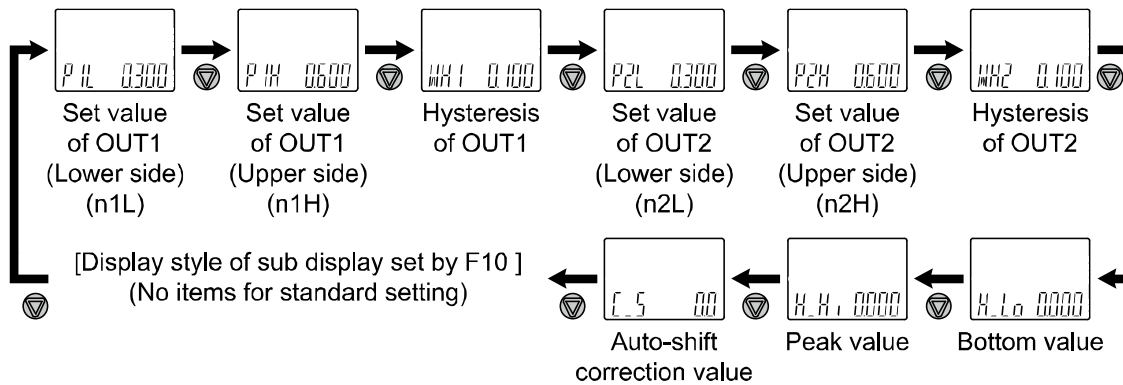







•2 value display

The 2 value display function displays the items listed below on the right and left side of the sub display.

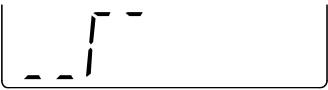
List of items for selection

Item	Details	Sub display		Remarks
		Left side	Right side	
P ₁ (n ₁)	Set value for OUT1 hysteresis mode	○	○	When hysteresis mode is selected
H ₁	OUT1 hysteresis mode	○	○	When hysteresis mode is selected
P _{1L} (n _{1L})	OUT1 Window comparator mode set value (Lower side)	○	○	When window comparator mode is selected
P _{1H} (n _{1H})	OUT1 Window comparator mode set value (Upper side)	○	○	When window comparator mode is selected
WH ₁	OUT1 window comparator mode	○	○	When window comparator mode is selected
P ₂ (n ₂)	Set value for OUT2 hysteresis mode	○	○	When hysteresis mode is selected
H ₂	OUT2 hysteresis mode	○	○	When hysteresis mode is selected
P _{2L} (n _{2L})	OUT2 Window comparator mode set value (Lower side)	○	○	When window comparator mode is selected
P _{2H} (n _{2H})	OUT2 Window comparator mode set value (Upper side)	○	○	When window comparator mode is selected
WH ₂	OUT2 window comparator mode	○	○	When window comparator mode is selected
H _{H1}	Pressure peak value	○	×	
H _{L0}	Pressure bottom value	×	○	
C _S	Auto-shift correction value	○	○	
Unit	Pressure display unit	○	○	
rPrng	Rated pressure range	○	○	
Mod1	OUT1 output mode/output style	○	×	
Mod2	OUT2 output mode/output style	×	○	
Line	String of random characters	○	×	Line name 4 left digits
Line	String of random characters	×	○	Line name 5 right digits
CH	Channel display	○	○	
M ₁	Measured value of CH1	○	○	
M ₂	Measured value of CH2	○	○	
M ₃	Measured value of CH3	○	○	
M ₄	Measured value of CH4	○	○	
OFF	Display OFF	○	○	

Table showing the output mode and output form when Md1 and Md2 are selected.

Output mode	Output style	Display style
Hysteresis mode	Normal output	
	Reversed output	
Window comparator mode	Normal output	
	Reversed output	
Error output	Normal/Reversed output	
Switch output off	-	

When using the 2 value display function, 3 step setting is not available for the display.
 (When setting 3 step, select each set value to be displayed by pressing the DOWN button.)

When output operation mode is changed after selecting the 2 value display, the selected display items will not be applicable and [- -] will be displayed. In this case, select items for the 2 value display setting again.

•Level bar display

The Level bar display is a function used to visualize the pressure and the ON area for the switch output on the sub display.

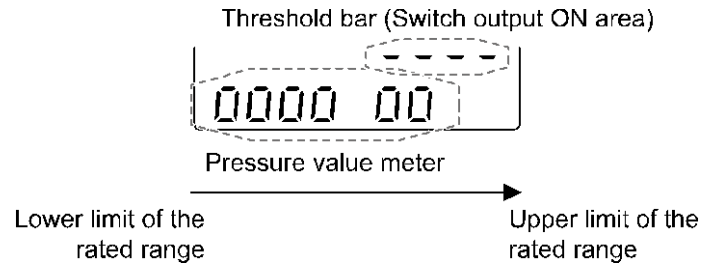

The display style varies depending on the setting of the output mode.

(In hysteresis mode or window comparator mode)

The threshold bar displaying the switch output ON area is displayed according to the table below, using the output mode.

(During error output or when the switch output is OFF)

The threshold bar will not be displayed. Only the pressure value meter is displayed.

Output mode	Output style	Threshold bar display style
Hysteresis mode	Normal output	P ₁
	Reversed output	n ₁
Window comparator mode	Normal output	P1L P1H
	Reversed output	n1L n1H
Error output	Normal/Reversed output	No indication
Switch output off	-	No indication

The Level bar display resolution (pressure for one "O") varies depending on the output mode.

Output mode	Display resolution	
	OUT1	OUT2
Hysteresis mode	1/10 of P ₁ (n ₁)	1/10 of P ₂ (n ₂)
Window comparator mode	1/4 of P1H – P1L (n1H – n1L)	1/4 of P2H – P2L (n2H – n2L)
Error output	1/7 of rated maximum pressure - rated minimum pressure	
Switch output off		

During an error output or when the switch output setting is OFF, the pressure value meter at the atmospheric pressure is displayed according to the table below.

Rated range	Display at atmospheric pressure	
Other than compound pressure		or
Compound pressure		or

•Character string display

•Function to display the specified character string on the sub-screen.

When line name is input, characters which can be displayed for each digit are as follows.

(Display pattern for 3rd, 4th, 5th, 8th and 9th digit from the left)

Characters Q, X, Z, /, or * cannot be displayed.

A	B	C	D	E	F	G	H	I	J	K	L	M	N	O	P	R	S	T	U	V	W	Y

0	1	2	3	4	5	6	7	8	9	Symbol	Space

(Display patter for 1st., 2nd., 6th., and 7th digit)

Characters A to Z can be displayed (the same as the 3 digits on the right).

A	B	C	D	E	F	G	H	I	J	K	L	M	N	O	P	Q	R	S	T	U	V	W	X	Y	Z

<Pattern for 3 digits on the right>

0	1	2	3	4	5	6	7	8	9	Symbol	K	M	N	R	V	W	Space

•Display OFF

The Sub display is not displayed.

■[F11] Display resolution setting

This function is to change the pressure display resolution.
The flicker of the display can be reduced.

<Operation>

Press the UP or DOWN button in function selection mode to display [F11].

Press the SET button. ↓ Move on to display resolution setting.

Display resolution setting

Press the UP or DOWN button to select the display resolution.

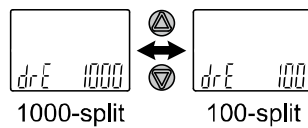

Press the SET button to set. ↓ Return to function selection mode.

[F11] Display resolution setting completed

*: The display resolution is not possible to be selected while setting the additional range.

*: It may not be possible to change the resolution depending on the unit of pressure selected.

The units that allow display resolution to be selected are [MPa], [kPa], [kgf/cm²], [bar], [mbar], [psi], [inHg] and [mmH₂O].

(The units [kgf/cm²], [bar], [mbar], [psi], [inHg] and [mmH₂O] can only be set when using a product with units selection function.)

➡ Page 32 [F 0] Differential pressure check mode, pressure range and display unit

■[F14] Zero cut-off setting

When the pressure display value is close to zero, the product rounds the value and zero will be displayed. The zero cut-off range is 0.0 to 10.0% F.S., and can be set in 1.0% F.S. increments.

*: Zero-cut setting cannot be selected when auto-shift zero is set.

<Operation>

Press the UP or DOWN button in function selection mode to display [F14].

Press the SET button. ↓ Move on to select zero cut-off setting.

Select zero cut-off setting

Press the UP or DOWN button to select the value of zero cut-off.

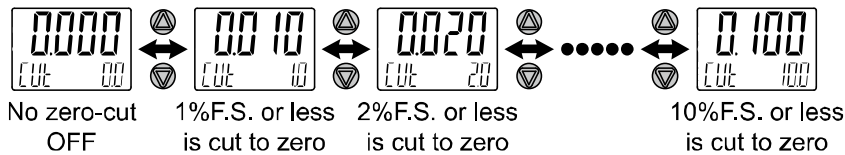

*: The display above is an example when 1 MPa range and unit selection function are [MPa] selected.

*: When the actual pressure is smaller than the displayed value in the upper line, zero will be displayed.

Example: 1 MPa range $P_1 = 0.015$ [MPa], $H_1 = 0.01$ [MPa], zero cut-off 1.0%

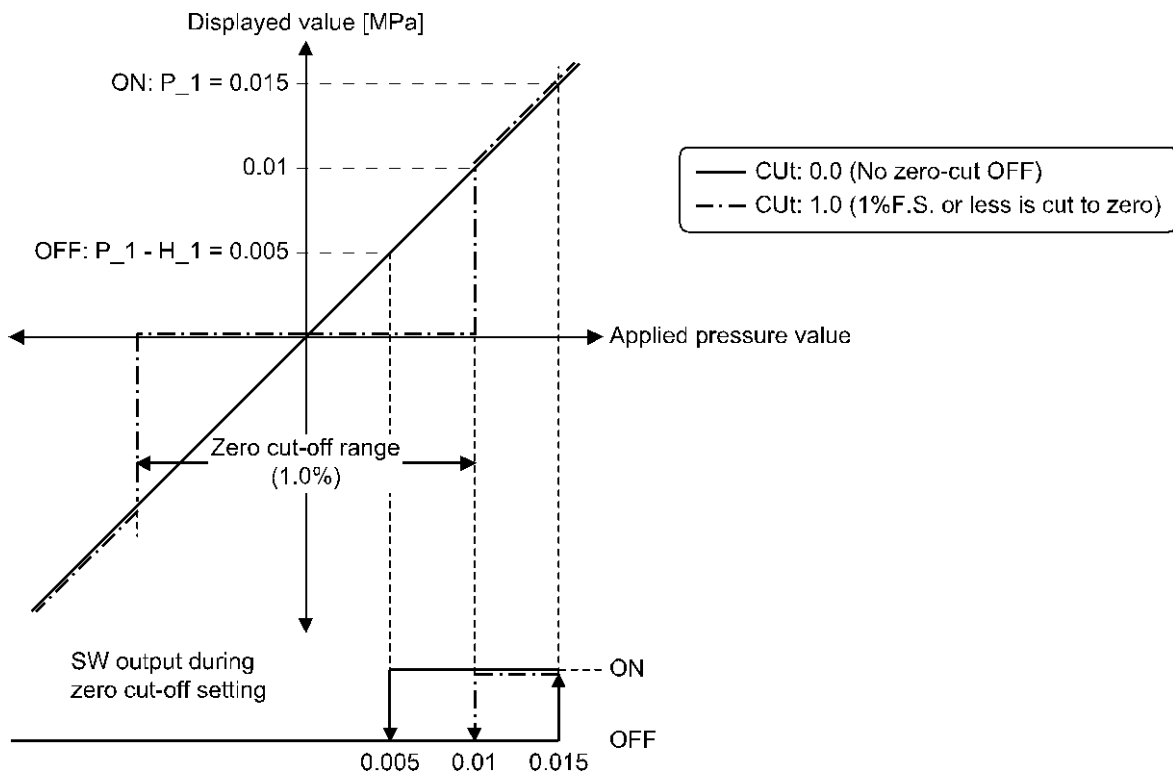

Press the SET button to set. ↓ Return to function selection mode.

[F14] Zero cut-off setting completed

■[F80] Power saving mode

Power saving mode can be selected.

When selected and no buttons are pressed for 30 seconds, the product will shift to power saving mode.

<Operation>

Press the UP or DOWN button in function selection mode to display [F80].

Press the SET button. ↓ Move on to power saving mode.

Power saving mode (Setting common for all channels)

Press the UP or DOWN button to select the power saving mode.

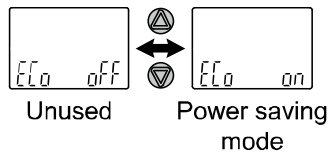

Press the SET button to set. ↓ Return to function selection mode.

[F80] Power saving mode completed

In power saving mode, when buttons are pressed the display is normal, but if no buttons are pressed for 30 seconds, it will revert to power saving mode. (Power saving is only enabled in measurement mode)

During power saving mode, [ECo] will flash in the sub display and the operation light is ON (only when the switch is ON).

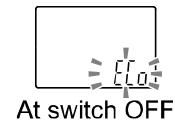
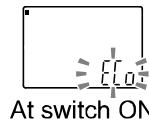

■[F81] Security code

The security code can be turned on or off and the security code can be changed when unlocked.

<Operation>

Press the UP or DOWN button in function selection mode to display [F81].

Press the SET button. ↓ Move on to security code.

Security code (Setting common for all channels)

Press the UP or DOWN button to select the setting of security code.

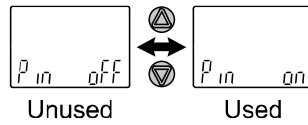

[oFF] (not use) is selected.
Press the SET button to return to function selection mode.

Press the SET button to set. ↓ Move on to security code checking.

Security code checking

Press the UP or DOWN button to input the security code on the sub display (right).
(The default setting is [000].) *

For instructions on how to enter the security code, refer to "How to input and change the security code" on page 70.

If the security code entered is incorrect, [FAL] will be displayed, and the security code must be entered again.

If the wrong security code is entered 3 times, [nG] is displayed and the device returns to function selection mode.

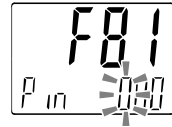

Press the SET button for 1 second to set. ↓ Move on to security code changing.

Security code changing

Press the UP or DOWN button to input the changed security code on the main display. *
For instructions on how to enter the security code, refer to "How to input and change the security code" on page 70.



After entry, the changed security code will flash by pressing the SET button for 1 second.
(At this point, the changing of the security code is not completed)
Return to the change of setting again by pressing the UP or DOWN button.



Press the SET button for 1 second to set. ↓ Return to function selection mode.

[F81] Security code completed

If the security code function is enabled, it is will be necessary to input a security code to release the key-lock.

*: If a key is not pressed for 30 seconds while entering the security code, function selection mode will return.

● **Special function setting**

■ **[F90] Setting of all functions**

All functions can be set in turn.

<Operation>

Press the UP or DOWN button in function selection mode to display [F90].

Press the SET button. ↓ Move on to setting of all functions.

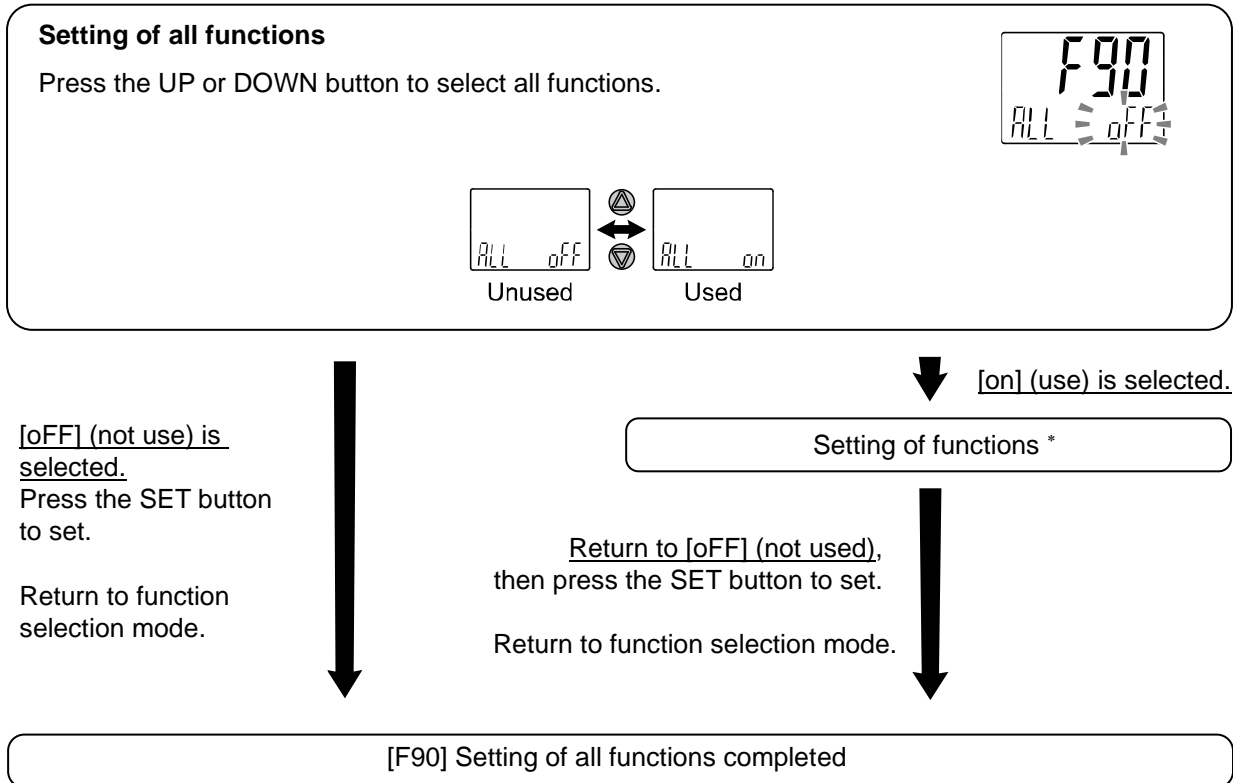

*: Setting of each function

Every time the SET button is pressed, the display moves to the next function in order of "Setting of each function" on page 61. Set by using the UP and DOWN buttons.

For details of how to set each function, refer to the relevant setting of function section in this manual.

*: Measurement mode can be returned from any setting items by pressing and holding the SET button for 2 seconds or longer.

*: The function setting from before returning to the measurement mode is maintained.

● Setting of each function

Order	Function
1	Differential pressure check mode setting
2	Pressure range setting
3	Display unit selection
4	Output mode setting of OUT1
5	Reversed output setting of OUT1
6	Pressure setting of OUT1
7	Hysteresis setting of OUT1
8	Delay time setting of OUT1
9	Display colour setting
10	Output mode setting of OUT2
11	Reversed output setting of OUT2
12	Pressure setting of OUT2
13	Hysteresis setting of OUT2
14	Delay time setting of OUT2
15	Display colour setting
16	Digital filter setting
17	Auto-preset function
18	Auto-shift setting
19	Fine adjustment of display value
20	Sub display setting
21	Display resolution setting
22	Zero cut-off setting
23	Power saving mode
24	Security code

*: Measurement mode can return from any setting item by pressing the SET button for 2 seconds or longer.

*: Function set before returning to the measurement mode is maintained.

■[F95] Channel to channel copy function setting

Set channel to channel copy function.

<Operation>

Press the UP or DOWN button in function selection mode to display [F95].

Press the SET button. ↓ Move on to channel to channel copy function setting.

Channel to channel copy function setting

Set values between [F 0] and [F80] are copied to the other channel (except [F 6] Finely adjusted value).

Press the UP or DOWN button to select the channel to channel copy function.

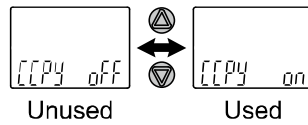

[OFF] (not use) is selected.

Press the SET button to return to function selection mode.

[on] (use) is selected.
Press the SET button to set.

Select the channel to be copied

Press UP or DOWN button to select the channel to be copied in the sub screen (on the right).

*: Channel from which a copy is made of the currently selected channel.

Displayed in the the sub screen (on the left).

*: When changing the channel to be copied, change the channel in measurement mode and the select function again.

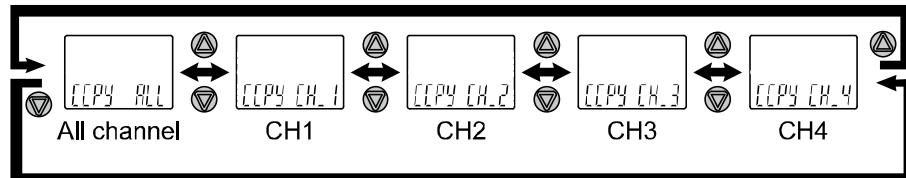

Press the SET button to start copying. When copying is finished, the mode returns to channel to channel copy function setting.

When UP and DOWN buttons are pressed simultaneously, copying is NOT performed, but returns to channel to channel copy function setting.

Channel to channel copy function setting

Press the SET button to set. ↓ Return to function selection mode.

[F95] Channel to channel copy function setting is completed

■[F96] Sensor input/External input signal status display

The sensor input signal (1 to 5 V) and the external input signal can be checked.

<Operation>

Press the UP or DOWN button in function selection mode to display [F96].

Press the SET button. ↓ Move on to sensor input/external input signal status display.

Sensor input/External input signal status display

Select to display the sensor input or external input signal condition by pressing the SET button.

*: Only the sensor input can be displayed if the external input signal [F 5] is not set.

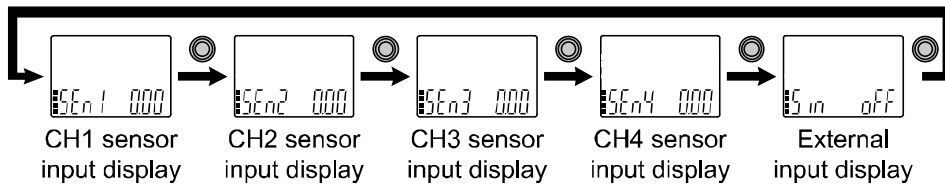

■[F98] Output check

Correct operation of the switch output can be confirmed.
The output can be turned ON/OFF manually.

<Operation>

Press the UP or DOWN button in function selection mode to display [F98].

Press the SET button. ↓ Move on to output check.

Output check

Press the UP or DOWN button to select output check.





Normal output
(Output not checked)





Forcibly output
(Output is checked)

[n] (Normal output) is selected.
Press the SET button to set.

Return to function selection mode

[F] (Forced output) is selected.
Press the SET button to set.

OUT1 output check (CH1)

Press the UP or DOWN button to select OUT1 output check.



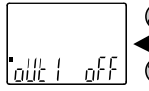

Forcibly output
OFF



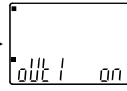

Forcibly output
ON

Press the SET button to set. ↓

OUT2 output check (CH1)

Press the UP or DOWN button to select OUT2 output check.



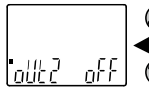

Forcibly output
OFF



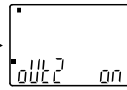

Forcibly output
ON

Press the SET button to set. ↓

OUT1 output check (CH2)

Press the UP or DOWN button to select OUT1 output check.

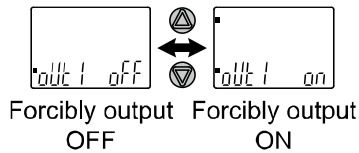

Press the SET button to set. ↓

OUT1 output check (CH3)

Press the UP or DOWN button to select OUT1 output check.

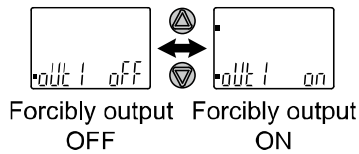

Press the SET button to set. ↓

OUT1 output check (CH4)

Press the UP or DOWN button to select OUT1 output check.

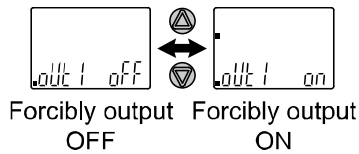

Press the SET button to return to [n] (normal output), then press the SET button to set.

Return to function selection mode.

[F98] Output check completed

*: Measurement mode can return from any setting item by pressing the SET button for 2 seconds or longer.

■[F99] Reset to default settings

If the product settings are uncertain, the default values can be restored.

*: All channels return to default condition.

<Operation>

Press the UP or DOWN button in function selection mode to display [F99].

Press the SET button. ↓ Move on to reset to default settings.

Reset to default settings

Press the UP or DOWN button to display [ON], then press the SET and DOWN buttons simultaneously for 5 second or longer.

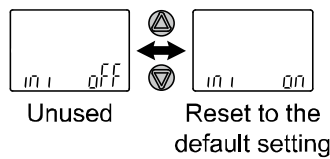

[oFF] (not use) is selected.
Press the SET button to set.

Return to function selection mode.

All settings are returned to the default values. Return to function selection mode.

[F99] Reset to default settings completed

Other Settings

○Channel scan function

•Press the UP button for 2 seconds or longer. Channels and the measured pressures will be displayed in order approximately every 2 seconds.

•The function can be released by pressing the UP button again for 2 seconds or longer.

*: Channel scan function will remain even when the power supply is turned off.

*: During channel scan, setting is disabled other than channel scan mode release and key lock function setting.

Release the channel scan mode when changing settings.

○Snap shot function

The current pressure value can be stored to the switch output ON/OFF set point.

When the items of sub display (left) below are selected in 3 step setting mode, simple setting mode or function selection mode ([F 1] Setting of OUT1, [F 2] Setting of OUT2), by pressing the UP and DOWN buttons simultaneously for 1 second or longer, the value of the sub display (right) shows [- - -], and the values corresponding to the current pressure values are automatically displayed.

Output mode	Configurable items	Sub display (left)	Snap shot function
Hysteresis mode	Set value	$P_{-1} (n_{-1}) / P_{-2} (n_{-2})$	○
	Hysteresis	H_1 / H_2	○
Window comparator mode	Set value	$P_{1L} (n_{1L}), P_{1H} (n_{1H})$ $P_{2L} (n_{2L}), P_{2H} (n_{2H})$	○
	Hysteresis	H_{1L} / H_{1H} H_{2L} / H_{2H}	×

•Set value

The value is set to the same value as the display value (current pressure value).

(There is a range which cannot be set to the current pressure depending on the hysteresis. In that case, the value is set to the closest value.)

•Hysteresis

The hysteresis is calculated from the equation below and set.

Normal output: (set value) - (current pressure value) Reverse output: (current pressure value) - (set value)

If the calculation result becomes 0 or less, [Err] is displayed on the sub display (right) and the set value is not changed.

Afterwards, it is possible to adjust the value by pressing the UP or DOWN button.

○Peak/bottom value indication

The maximum (minimum) pressure when the power is supplied is detected and updated.

In peak/bottom indication mode, the current pressure is displayed.

Press the DOWN button in measurement mode to switch the sub-display (left) to the display shown below.

Peak/bottom values are displayed on the sub display (right) at the same time as the current pressure value on the main display.

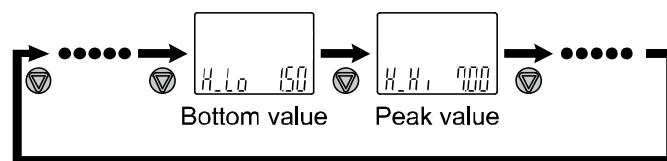

When the SET and DOWN buttons are pressed for 1 second or longer simultaneously while the peak/bottom values are displayed, the sub display (right) displays [- - -] and the maximum (minimum) pressure value are cleared.

*: Peak/ bottom value are not stored to memory.

○Zero-clear function

The displayed value can be adjusted to zero if the pressure being measured is within $\pm 7\%$ F.S ($\pm 3.5\%$ F.S. for compound pressure) of the zero point set at the time of default settings.

(The zero clear range varies by $\pm 1\%$ F.S. due to variation between individual products.)

In measurement mode, when the UP and DOWN buttons are pressed for 1 second or longer simultaneously, the main display shows [- - -], and the reset to zero. The display returns to measurement mode automatically.

○Key-lock function

The key-lock function is used to prevent errors occurring due to unintentional changes of the set values. If the SET button is pressed while the keys are locked, [LoC] is displayed on the sub display (left) for approximately 1 second.

(Each setting and peak/bottom values are displayed with UP and DOWN buttons.)

<Operation - Without security code input ->

(1) Press the SET button for 5 seconds or longer in measurement mode. When [oPE] is displayed on the main display, release the button.

The current setting [LoC] or [UnLoC] will be displayed on the sub display.

(To release key-lock repeat the above operation.)

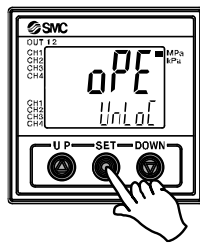

(2) Select the key-locking/un-locking with UP or DOWN button, and press the SET button to set.

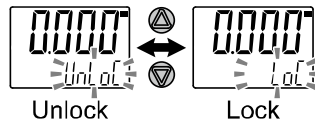

<Operation – With security code input ->

•Locking

- (1) Press the SET button for 5 seconds or longer in measurement mode. When [oPE] is displayed on the main display, release the button.

The current setting [LoC] or [UnLoC] will be displayed on the sub display.

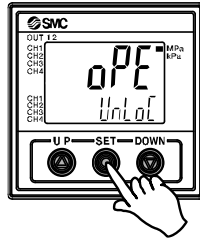

- (2) Select the key [LoC] with UP or DOWN button, and press the SET button to set.

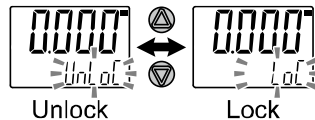

•Unlocking

- (1) Press the SET button for 5 seconds or longer in measurement mode. When [oPE] is displayed on the main display, release the button.

The current setting [LoC] or [UnLoC] will be displayed on the sub display.

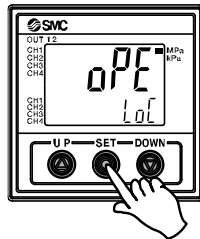

- (2) Select the un-locking [UnLoC] with UP or DOWN button. Setting is recognized by pressing the SET button, then security code is required.

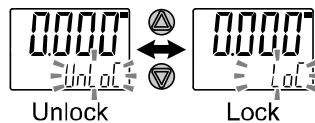

- (3) For instructions on how to enter the security code, refer to "How to input and change the security code" on page 70.

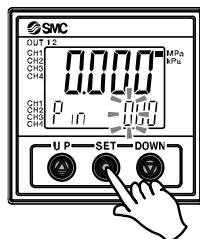

- (4) If inputted security code is correct, the indication of the main display changes to [UnLoC], and pressing the one of UP, SET or DOWN button releases key-lock and the measurement mode returns. If the security code entered is incorrect, [FAL] will be displayed, and the security code must be entered again. If the wrong security code is entered 3 times, [LoC] is displayed and the device returns to measurement mode.

●How to input and change the security code

The left most digit starts flashing.

Press the UP or DOWN button to select a value.

Press the SET button to make the next digit to the right flash.

(If the SET button is pressed at the last digit, the first digit will start flashing.)

After the setting is complete, Press and hold the SET button for 1 second or longer.

(If an operation is not performed for 30 seconds during input or change of the security code, it will return to measurement mode.)

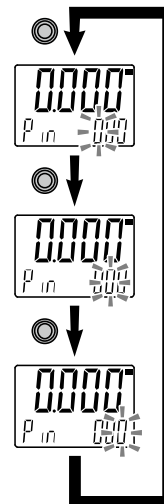

Maintenance

How to reset the product after a power cut or forcible de-energizing

The setting of the product will be retained as it was before a power cut or de-energizing. The output condition is also basically recovered to that before a power cut or de-energizing, but may change depending on the operating environment. Therefore, check the safety of the whole installation before operating the product. If the installation is using accurate control, wait until the product has warmed up (approximately 10 to 15 minutes).

Forgotten the security code

If you have forgotten your security code, please contact SMC directly.

Troubleshooting

○Troubleshooting

When any failure occurs with this product, the following chart can be used to identify the cause of the failure. If a cause applicable to the troubles cannot be identified and normal operation is recovered by replacement with a new product, this indicates that the product itself was faulty. Problems with the product may be due to the operating environment (installation etc). Please consult SMC.

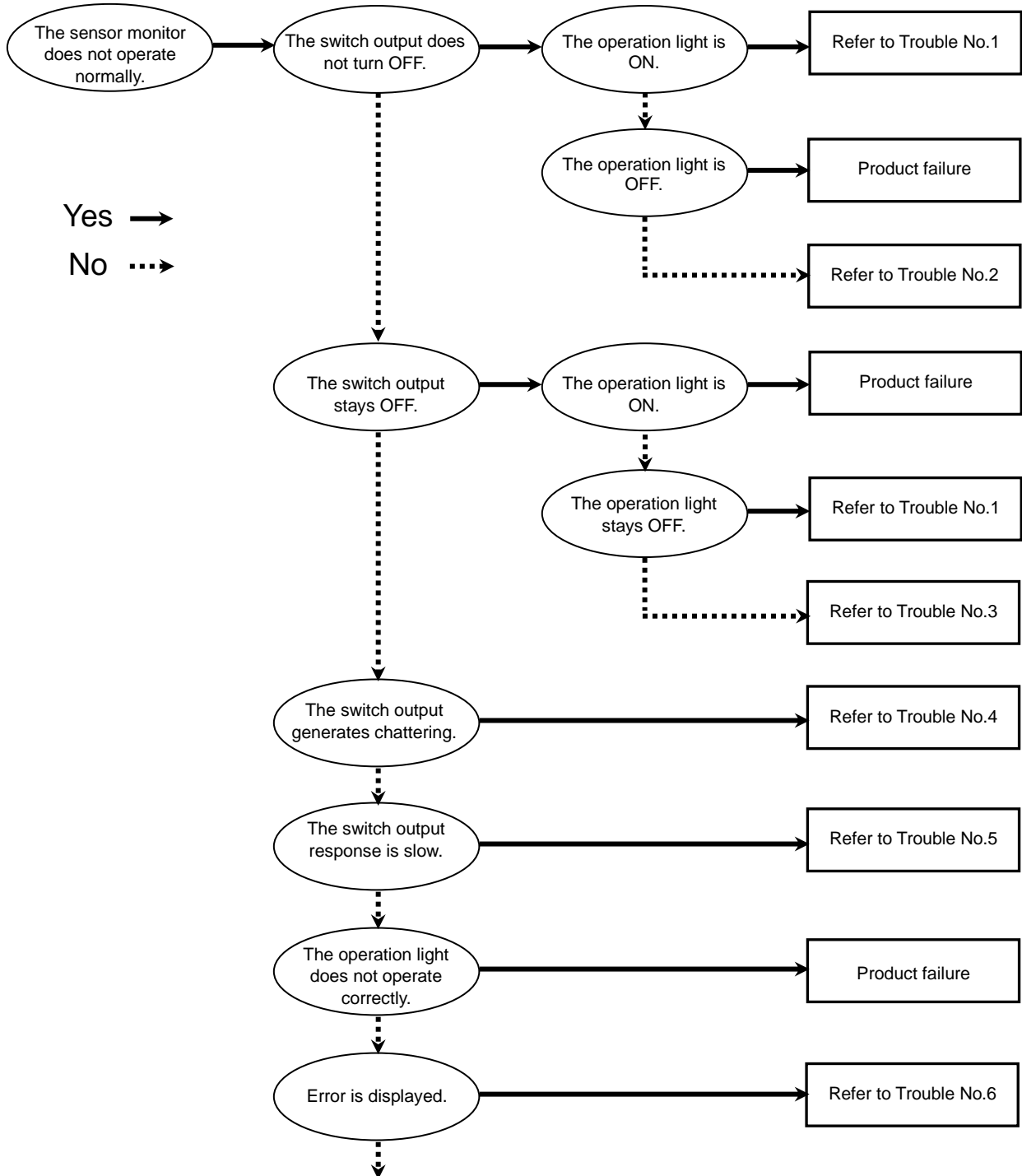

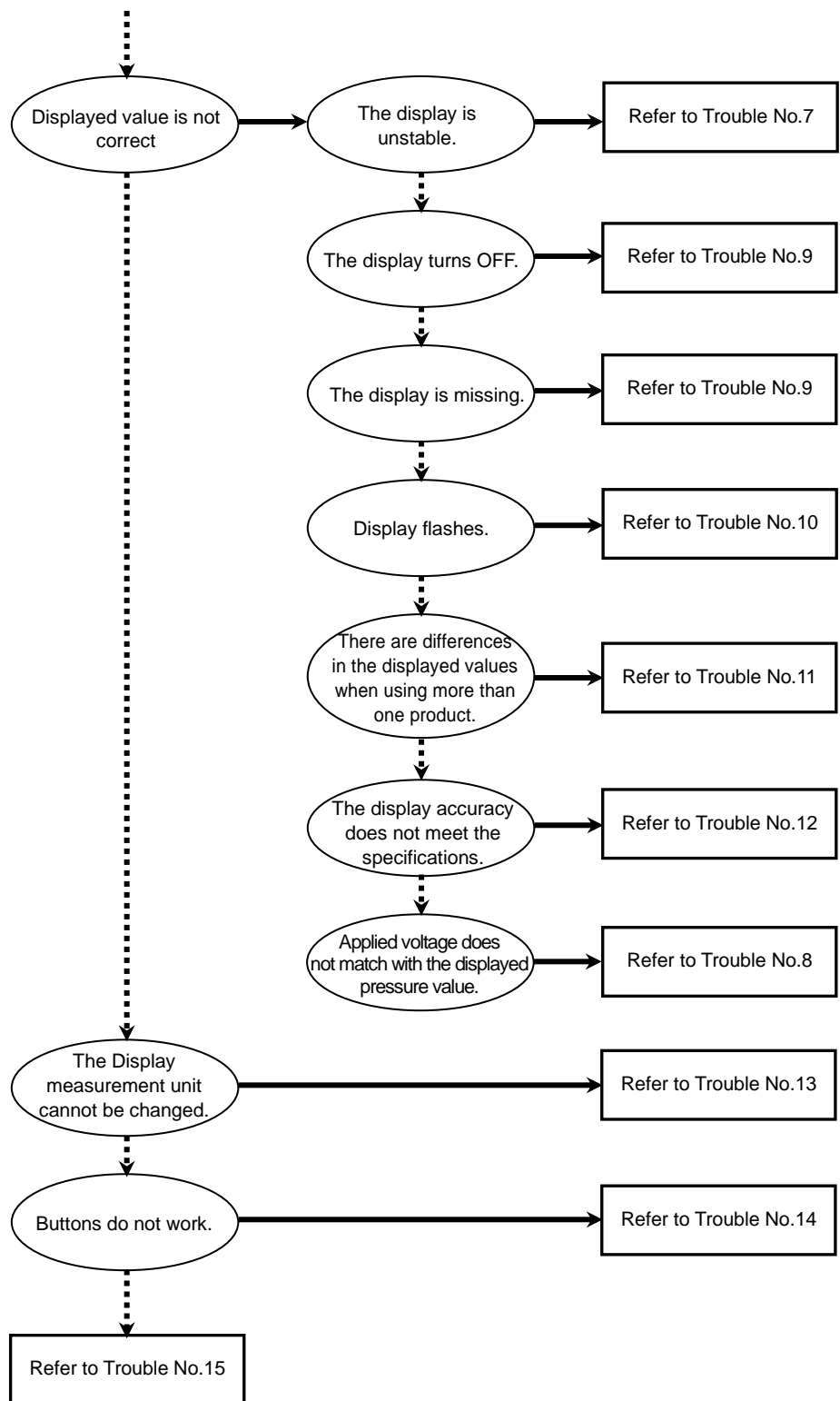

○Troubleshooting list

Problem No.	Problem	Problem possible causes	Investigation method	Countermeasures
1	<ul style="list-style-type: none"> •The switch output does not turn OFF. The operation light stays ON. •The switch output does not turn ON. The operation light stays OFF. 	Incorrect pressure setting	(1) Check the set pressure value. (2) Check the settings of the operation mode, hysteresis and output type. (In hysteresis mode or window comparator mode, and normal output/ reversed output)	(1) Adjust the set pressure value. (2) Set the operation mode, hysteresis and output type again.
		Product failure		Replace the product.
2	The switch output does not turn OFF. The operation light is normal.	Incorrect wiring	Check the output wiring. Check if the load is directly connected to DC(+) or DC(-).	Check and correct the wiring.
		Product failure		Replace the product.
3	The switch output is OFF. The operation light is normal.	Incorrect wiring	Check the output wiring. Check if the load is directly connected to DC(+) or DC(-).	Check and correct the wiring.
		Model selection	Check if PNP output is used when NPN should have been selected, or the other way around.	Revise the model selection (output specification).
		Lead wire broken	Check if there is bending stress applied to any part of the lead wire. (bending radius, tensile force to the lead wire)	Correct the wiring. (Reduce the tensile force or increase the bending radius.)
		Product failure		Replace the product.
4	The switch output generates chattering.	Incorrect wiring	Check the wiring. Check if the brown and blue wires are connected to DC(+) and DC(-) respectively, and if the output line is secure (contact failure).	Correct the connection on the power cord and the plug.
		Incorrect pressure setting	(1) Check the set pressure value. (2) Check if the hysteresis range is small. (3) Check the delay time setting. Check if the delay time is too short.	(1) Adjust the set pressure value. (2) Make the hysteresis wider. (3) Set the delay time again.
		Product failure		Replace the product.
5	The switch output response is slow.	Incorrect pressure setting	Check the set pressure value. Check if the detected pressure and the set pressure values are the same or are too close.	Adjust the set pressure value. Ensure the set pressure value is not too close to the detected pressure value.



Problem No.	Problem	Problem possible causes	Investigation method	Countermeasures
6	<ul style="list-style-type: none"> •Over current error (Er1) is displayed. •System error (Er0, 4, 6, 7, 8, 9) is displayed. •"HHH" is displayed. •"LLL" is displayed. • Residual pressure error (Er3) is displayed. 	Excess current was applied to the output (Er1)	<ol style="list-style-type: none"> (1) Check if the output current is 80 mA or more. (2) Check if the connected load complies with the specification. Check if the load is short circuited. (3) Check if the relay without surge protection is connected. (4) Check if the wiring is in the same route as (or bundled together with) a high-voltage or power line. 	<ol style="list-style-type: none"> (1)(2) Connect the appropriate load. (3) Use a relay with a surge voltage suppressor or take measures to prevent surge. (4) Separate the wiring from the high-voltage and/or power line.
		Incorrect internal data processing of the product (Er0, 4, 6, 7, 8 and 9)	<ol style="list-style-type: none"> (1) Check if there is noise interference (such as static electricity). Check if there is a noise source nearby. (2) Check if the power supply voltage is in the range 12 to 24 VDC $\pm 10\%$. 	<ol style="list-style-type: none"> (1) Remove the noise and the noise source (or take measures to prevent noise interference), and reset the product (or turn off and then turn back on the power supply). (2) Supply power in the range 12 to 24 VDC $\pm 10\%$.
		Applied pressure is higher than the upper limit (HHH)	<ol style="list-style-type: none"> (1) Check if the pressure exceeds the upper limit of the set pressure range. (2) Check if foreign matter has entered the piping. 	<ol style="list-style-type: none"> (1) Reset applied pressure to a level within the set pressure range. (2) Take measures to prevent foreign matter from entering the piping.
		Applied pressure is lower than the lower limit (LLL)	<ol style="list-style-type: none"> (1) Check if the pressure exceeds the lower limit of the set pressure range. (2) Check if foreign matter has entered the piping. 	<ol style="list-style-type: none"> (1) Reset applied pressure to a level within the set pressure range. (2) Take measures to prevent foreign matter from entering the piping.
		Pressure is not atmospheric pressure when zero-clear is performed (Er3)	Check if the pressure exceeded the atmospheric pressure within $\pm 7\%$ F.S. ($\pm 3.5\%$ F.S. for compound pressure).	Release the applied pressure to atmospheric pressure, and retry the zero clear operation.
		Product failure		Replace the product.
		7	The display is unstable.	Incorrect power supply
Incorrect wiring	Check the power supply wiring. Check if the brown and blue wires are connected to DC(+) and DC(-) respectively, and if the wiring is secure.			Check and correct the wiring.
Factory line pressure is not stable	Check if the factory line pressure is changing.			If the fluctuation is not acceptable, the number of digits (display sensitivity) can be reduced by changing the display resolution. Digital filter setting may improve the condition.

Problem No.	Problem	Problem possible causes	Investigation method	Countermeasures
8	Applied voltage does not match with the displayed pressure value.	Incorrect pressure range setting	Check the pressure range setting. Check if the connected pressure sensor and the set pressure range are correct.	Select the correct pressure range.
9	<ul style="list-style-type: none"> •The display turns OFF. •Part of the display is missing. 	Incorrect power supply	Check if the power supply voltage is in the range 12 to 24 VDC \pm 10%.	Supply power in the range 12 to 24 VDC \pm 10%.
		Incorrect wiring	Check the power supply wiring. Check if the brown and blue wires are connected to DC(+) and DC(-) respectively, and if the wiring is secure.	Check and correct the wiring.
		Power saving mode	Check if power saving mode is selected.	Select the power saving mode again.
		Product failure		Replace the product.
10	Display flashes.	Incorrect wiring	(1) Check the power supply wiring. (2) Check if there is bending stress applied to any part of the lead wire.	(1) Check and correct the wiring. (2) Correct the wiring (bend radius and stress).
11	Pressure display is unstable when products are in close proximity to each other.	Variation within the display accuracy range	Check if the variation is within the display accuracy range.	Use the fine adjustment mode to adjust the display if the variation is within the display accuracy range.
		Product failure		Replace the product.
12	The display accuracy does not meet the specifications.	Foreign matter entered	Confirmed foreign matter entry or sticking to the piping port.	Use 5 μ m of filter to prevent foreign matter from entering or sticking. Discharge the condensate of the filter periodically.
		Air or liquid leakage	Check if air or liquid are leaking from the piping.	Rework the piping. If the tightening torque is exceeded, the mounting screws, brackets and the product may be damaged.
		Warming up inadequate	Check if the product satisfies the specified accuracy 10 minutes after supplying power.	After energizing, the display and output can drift. For precise pressure detection, allow the product to warm up for 10 to 15 minutes.
		Product failure		Replace the product.

Problem No.	Problem	Problem possible causes	Investigation method	Countermeasures
13	Display measurement unit cannot be changed.	Model selection (model selected does not have units selection function)	Check if the product number printed on the product indicates units selection function type.	Unit s selection function is not available for fixed to SI units type. (kPa↔MPa is available) *: The units selection function is not for use in Japan due to a new measurement law. *: Fixed to SI units: kPa, MPa
		Product failure		Replace the product.
14	Buttons do not work.	Key-lock mode is activated	Check if the key-lock function is turned on.	Check the key-lock function.
		Product failure		Replace the product.
15	The operation is unstable. (chattering)	Effect of line pressure fluctuation because hysteresis is too narrow or delay time of the switch is too short	(1) Check the set pressure values (hysteresis) (2) Check the delay time.	(1) Adjust the set pressure value. (2) Change the response time setting.
		Incorrect wiring/broken lead wire	(1) Check the power supply wiring. (2) Check if there is bending stress applied to any part of the lead wire. (bending radius, tensile force to the lead wire)	(1) Check and correct the wiring. (2) Correct the wiring. (Reduce the tensile force or increase the bending radius.)
		Product failure		Replace the product.

○Error indication function

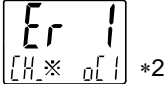
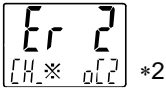
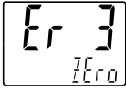
This function is to display error location and content when a problem or error has occurred.

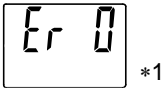
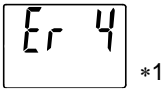
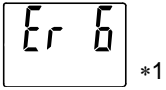
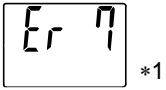
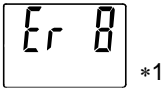
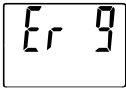
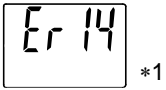
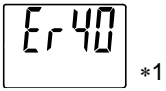
Error	Error displayed	Description	Measures	Error output
Over current error	 *2	The switch output load current is 80 mA or more. ※ indicates channel with error.	Turn the power off and remove the cause of the over current. Then supply the power again.	○
	 *2			
Residual pressure error		During zero clear operation, pressure greater than $\pm 7\%$ F.S. ($\pm 3.5\%$ F.S. for compound pressure) is present. Note that the mode is returned to measurement mode automatically 1 second later. The zero clear range varies by $\pm 1\%$ F.S. due to variation between individual products.	Release the applied pressure to atmospheric pressure, and retry the zero clear operation.	Not applicable
Pressurizing error		Pressure exceeding the upper limit of the set pressure range is applied.	Reset applied pressure to a level within the set pressure range. Check the sensor connection and wiring.	Not applicable
		Pressure exceeding the lower limit of the set pressure range is applied. Sensor is not connected or wired incorrectly.		Not applicable
System error	 *1	Displayed if an internal data error has occurred.	Turn the power off and on again. If the failure cannot be solved, contact SMC.	Not applicable
	 *1			Not applicable
	 *1			○
	 *1			Not applicable
	 *1			○
				○
	 *1			Not applicable
	 *1			○

*1: The switch output will be OFF when an error is generated.

An error is output when the error output is set (in the product with error output function).

*2: When the set output is an over current error when the error output is set, the switch output is OFF.

If the error cannot be reset after the above measures are taken, or errors other than above are displayed, please contact SMC.

Setting of the error output

In reversed output mode, error [Er0], [Er4], [Er7] and [Er14] can be detected.

Normal output

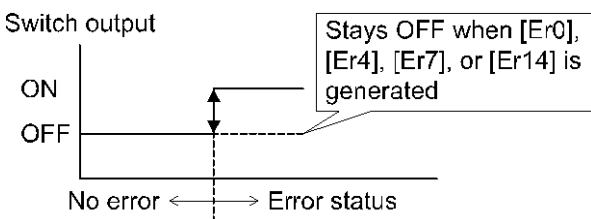

Reversed output

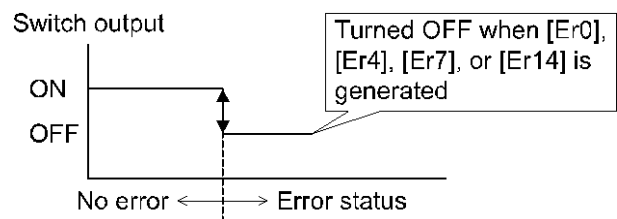

Specifications

Product No.		PSE20#A series
Pressure spec.	Rated pressure range	Refer to the table for each pressure specification (page 81)
	Display/set pressure range	
	Display/min. setting unit	
Electric spec.	Power supply voltage	12 to 24 VDC ($\pm 10\%$), and ripple (p-p) 10% at max.
	Current consumption	55 mA or less
	Protection	Polarity protection
	Power supply voltage for sensor	Power supply voltage: -1.5 V
	Power supply current for sensor *1	Max. 50 mA (Max. 200 mA for total power supply current when sensor 4 input)
Accuracy	Display accuracy	$\pm 0.5\%$ F.S. ± 1 digit (at ambient temperature 25 ± 3 °C)
	Repeatability	$\pm 0.1\%$ F.S. ± 1 digit
	Temperature characteristics	$\pm 0.5\%$ F.S. (25 °C standard)
Switch output	Output type	NPN or PNP open collector output 5 output
	Output mode	Hysteresis, window comparator, error output, output OFF
	Switch operation	Normal output, reversed output
	Maximum load current	80 mA
	Maximum applied voltage (NPN output)	30 VDC
	Internal voltage drop (Residual voltage)	1.5 V or less (Load current 80 mA)
	Delay time *2	5 ms or less, variable from 0 to 60 s/0.01 s increments
	Hysteresis	Variable from zero *3
	Protection	Over current protection
Sensor input	Input type	Voltage input: 1 to 5 VDC (Input impedance: 1 M Ω)
	Number of inputs	4 input
	Connection method	e-CON
	Protection	Over voltage protection (up to a voltage of 26.4 VDC)
Auto-shift input		Input with no voltage (Reed or solid state switch), Input time: 5 ms or more, Channel turns ON/OFF independently
Display	Unit *4	MPa, kPa, Pa, kgf/cm ² , bar, mbar, psi, inHg, mmHg, mmH ₂ O (depends on selected range)
	Display type	LCD
	Number of displays	3 (1 main display and 2 sub displays)
	Display colour	Main display: Red/Green, Sub display: Orange
	Number of display digits	Main display: 4 digits 7 segment Sub display (left): 4 digits (partially 11-segments, 7-segments for other) Sub display (right): 5 digits (partially 11-segments, 7-segments for other)
	Operation light	LED is ON when switch output is ON (OUT1, OUT2: Orange)
Digital filter *5		Variable from 0 to 30 s/0.01 s increments

Product No.		PSE20#A series
Environment	Enclosure	IP65 (front side only when the panel is mounted), IP40 for others *6
	Withstand voltage	1000 VAC for 1 minute between terminals and housing
	Insulation resistance	50 MΩ or more between terminals and housing (with 500 VDC megger)
	Ambient temperature range	Operation: 0 to 50 °C, Storage: -10 to 60 °C (No condensation)
	Operating humidity range	Operation and storage: 35 to 85%RH (No condensation)
Standard		CE/UKCA marked
Weight	Body	51 g (power supply and output cables are excluded)
	Power supply/output cable	60 g
	e-CON connector (1pc.)	2 g

*1: Monitor will be broken if Vcc of the sensor input connector and 0 V side.

*2: Value without digital filter (at 0 ms).

*3: If the applied pressure fluctuates around the set value, the hysteresis must be set to a value more than the amount of fluctuation or chattering will occur.

*4: This setting is only available for models with the units selection function. Only MPa, kPa or Pa is available for models without this function.

*5: The response time indicates when the set value is 90% in relation to the step input.

*6: When □48 mm conversion adapter is used, it satisfies IP40.

*7: Any products with tiny scratches, smears, or variations in the display colour or brightness, which does not affect the performance of the product, are verified as conforming products.

○Cable specification

Conductor area		0.15 mm ² (AWG26)
Insulator	Outside diameter	0.9 mm
Sheath	Finished outside diameter	φ4.8

○Table for each pressure specification

Applicable SMC pressure sensor	Rated pressure range	Display/set pressure range	Display/min. setting unit
PSE550	0 to 2 kPa	-0.2 to 2.1 kPa	0.001 kPa
PSE531, PSE541, PSE561	0 to -101 kPa	10 to -105 kPa	0.1 kPa
PSE533, PSE543, PSE563, PSE573	-100 to 100 kPa	-105 to 105 kPa	0.1 kPa
PSE532	0 to 100 kPa	-10 to 105 kPa	0.1 kPa
PSE564, PSE574	0 to 500 kPa	-50 to 525 kPa	1 kPa
PSE530, PSE540, PSE560, PSE570	0 to 1 MPa	-0.105 to 1.05 MPa	0.001 MPa
PSE575	0 to 2 MPa	-0.105 to 2.1 MPa	0.001 MPa
PSE576	0 to 5 MPa	-0.1 to 5.25 MPa	0.01 MPa
PSE577	0 to 10 MPa	-0.1 to 10.5 MPa	0.01 MPa

■Dimensions

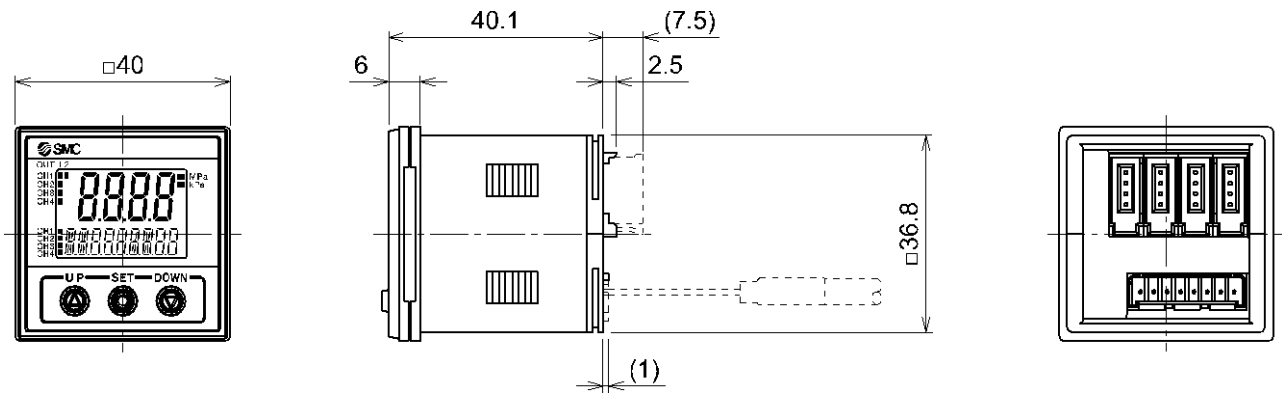

○Power supply/output cable

- ZS-26-L

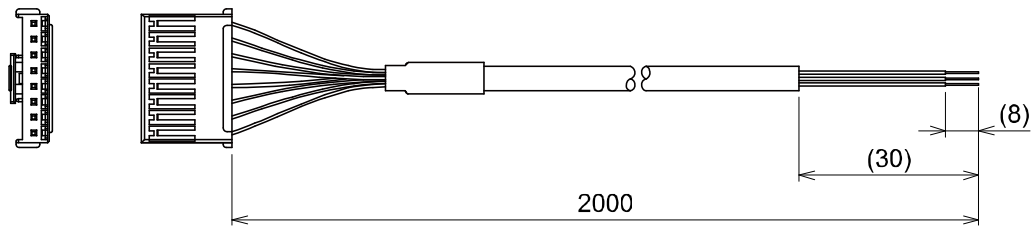

Revision history

A: Contents are added. [November 2019]
B: Contents are added. [November 2021]
C: Contents are added. [June 2022]
D: Contents are added. [June 2023]
E: Contents revised in several places. [May 2024]

SMC Corporation

Tel: + 81 3 5207 8249 Fax: +81 3 5298 5362
URL <https://www.smcworld.com>

Note: Specifications are subject to change without prior notice and any obligation on the part of the manufacturer.
© SMC Corporation All Rights Reserved



No.PS※※-OMW0005-E