



Operation Manual

PRODUCT NAME

Multi Channel Pressure Sensor Controller

MODEL / Series / Product Number

PSE200

SMC Corporation

Table of Contents

Safety Instructions	3
Model Indication and How to Order	9
Summary of Product parts	10
Definition and terminology	11
Mounting and Installation	14
Installation	14
Wiring	16
Internal circuit and wiring example	18
Setting of Function	19
Pressure Setting	23
Setting of Special Function	25
Other Settings	28
Maintenance	29
Troubleshooting	30
Specification	37
Specifications	37
Dimensions	38



Safety Instructions

These safety instructions are intended to prevent hazardous situations and/or equipment damage. These instructions indicate the level of potential hazard with the labels of “**Caution**,” “**Warning**” or “**Danger**.” They are all important notes for safety and must be followed in addition to International Standards (ISO/IEC)^{*)}, and other safety regulations.

*1) ISO 4414: Pneumatic fluid power - General rules and safety requirements for systems and their components
ISO 4413: Hydraulic fluid power - General rules and safety requirements for systems and their components
IEC 60204-1: Safety of machinery - Electrical equipment of machines - Part 1: General requirements
ISO 10218-1: Robots and robotic devices - Safety requirements for industrial robots - Part 1: Robots
etc.



Danger

Danger indicates a hazard with a high level of risk which, if not avoided, will result in death or serious injury.



Warning

Warning indicates a hazard with a medium level of risk which, if not avoided, could result in death or serious injury.



Caution

Caution indicates a hazard with a low level of risk which, if not avoided, could result in minor or moderate injury.

Warning

1. The compatibility of the product is the responsibility of the person who designs the equipment or decides its specifications.

Since the product specified here is used under various operating conditions, its compatibility with specific equipment must be decided by the person who designs the equipment or decides its specifications based on necessary analysis and test results. The expected performance and safety assurance of the equipment will be the responsibility of the person who has determined its compatibility with the product. This person should also continuously review all specifications of the product referring to its latest catalog information, with a view to giving due consideration to any possibility of equipment failure when configuring the equipment.

2. Only personnel with appropriate training should operate machinery and equipment.

The product specified here may become unsafe if handled incorrectly. The assembly, operation and maintenance of machines or equipment including our products must be performed by an operator who is appropriately trained and experienced.

3. Do not service or attempt to remove product and machinery/equipment until safety is confirmed.

1. The inspection and maintenance of machinery/equipment should only be performed after measures to prevent falling or runaway of the driven objects have been confirmed.
2. When the product is to be removed, confirm that the safety measures as mentioned above are implemented and the power from any appropriate source is cut, and read and understand the specific product precautions of all relevant products carefully.
3. Before machinery/equipment is restarted, take measures to prevent unexpected operation and malfunction.

4. Our products cannot be used beyond their specifications. Our products are not developed, designed, and manufactured to be used under the following conditions or environments. Use under such conditions or environments is not covered.

1. Conditions and environments outside of the given specifications, or use outdoors or in a place exposed to direct sunlight.
2. Use for nuclear power, railways, aviation, space equipment, ships, vehicles, military application, equipment affecting human life, body, and property, fuel equipment, entertainment equipment, emergency shut-off circuits, press clutches, brake circuits, safety equipment, etc., and use for applications that do not conform to standard specifications such as catalogs and operation manuals.
3. Use for interlock circuits, except for use with double interlock such as installing a mechanical protection function in case of failure. Please periodically inspect the product to confirm that the product is operating properly.



Safety Instructions

Caution

We develop, design, and manufacture our products to be used for automatic control equipment, and provide them for peaceful use in manufacturing industries.

Use in non-manufacturing industries is not covered.

Products we manufacture and sell cannot be used for the purpose of transactions or certification specified in the Measurement Act.

The new Measurement Act prohibits use of any unit other than SI units in Japan.

Limited warranty and Disclaimer/Compliance Requirements

The product used is subject to the following “Limited warranty and Disclaimer” and “Compliance Requirements”.

Read and accept them before using the product.

Limited warranty and Disclaimer

1. The warranty period of the product is 1 year in service or 1.5 years after the product is delivered, whichever is first.*2)

Also, the product may have specified durability, running distance or replacement parts. Please consult your nearest sales branch.

2. For any failure or damage reported within the warranty period which is clearly our responsibility, a replacement product or necessary parts will be provided.

This limited warranty applies only to our product independently, and not to any other damage incurred due to the failure of the product.

3. Prior to using SMC products, please read and understand the warranty terms and disclaimers noted in the specified catalog for the particular products.

***2) Vacuum pads are excluded from this 1 year warranty.**

A vacuum pad is a consumable part, so it is warranted for a year after it is delivered.

Also, even within the warranty period, the wear of a product due to the use of the vacuum pad or failure due to the deterioration of rubber material are not covered by the limited warranty

Compliance Requirements

1. The use of SMC products with production equipment for the manufacture of weapons of mass destruction (WMD) or any other weapon is strictly prohibited.

2. The exports of SMC products or technology from one country to another are governed by the relevant security laws and regulations of the countries involved in the transaction. Prior to the shipment of a SMC product to another country, assure that all local rules governing that export are known and followed.

Operator

- ◆ This operation manual is intended for those who have knowledge of machinery using pneumatic equipment, and have sufficient knowledge of assembly, operation and maintenance of such equipment. Only those persons are allowed to perform assembly, operation and maintenance.
- ◆ Read and understand this operation manual carefully before assembling, operating or providing maintenance to the product.

■ Safety Instructions

Warning

- Do not disassemble, modify (including changing the printed circuit board) or repair.
An injury or failure can result.
- Do not operate the product outside of the specifications.
Do not use for flammable or harmful fluids.
Fire, malfunction, or damage to the product can result.
Verify the specifications before use.
- Do not operate in an atmosphere containing flammable or explosive gases.
Fire or an explosion can result.
This product is not designed to be explosion proof.
- Do not use the product in a place where static electricity is a problem.
Otherwise it can cause failure or malfunction of the system.
- If using the product in an interlocking circuit:
 - Provide a double interlocking system, for example a mechanical system
 - Check the product regularly for proper operationOtherwise malfunction can result, causing an accident.
- The following instructions must be followed during maintenance:
 - Turn off the power supply
 - Stop the air supply, exhaust the residual pressure and verify that the air is released before performing maintenanceOtherwise an injury can result.

Caution

- Do not touch the terminals and connectors while the power is on.
Otherwise electric shock, malfunction or damage to the product can result.
- After maintenance is complete, perform appropriate functional inspections and leak tests.
Stop operation if the equipment does not function properly or there is a leakage of fluid.
When leakage occurred from other parts except piping, the product might break.
Cut off power supply and stop supplying fluid.
Do not apply fluid at leaking condition.
Safety cannot be assured in the case of unexpected malfunction.

■NOTE

○Follow the instructions given below when designing, selecting and handling the product.

- The instructions on design and selection (installation, wiring, environment, adjustment, operation, maintenance, etc.) described below must also be followed.

*Product specifications

- Use the specified voltage.
Otherwise failure or malfunction can result.
- Do not exceed the specified maximum allowable load.
Otherwise it can cause damage or shorten the lifetime of the Controller.
- Design the product to prevent reverse current when the circuit is opened or the product is forced to operate for operational check.
Reverse current can cause malfunction or damage to the product.
- Input data to the Controller is not deleted, even if the power supply is cut off.
(Writing time: 100,000 times, Data duration: 10 years after power off.)
- Reserve a space for maintenance.
Allow sufficient space for maintenance when designing the system.

●Product handling

*Installation

- Tighten to the specified tightening torque.
If the tightening torque is exceeded the mounting screws and brackets may be broken.
If the tightening torque is insufficient, the product can be displaced and loosen the mounting screws.
(Refer to "Mounting and Installation" on page 14.)
- Do not apply excessive stress to the product when it is mounted with a panel mount.
Otherwise damage to the product and disconnection from the panel mount can result.
- Be sure to ground terminal FG when using a commercially available switch-mode power supply.
- Do not drop, hit or apply shock to the Controller.
Otherwise damage to the internal parts can result, causing malfunction.
- Do not pull the lead wire forcefully, not lift the product by pulling the lead wire.
Power and output lead wire: 50N or less
Lead wire with connector for sensor: 25N or less
Hold the body when handling to avoid the damage of the Controller which lead to cause the failure and malfunction.
- Do not insert metal wires or other foreign matter into the pressure measurement port.
It can damage the pressure sensor causing failure or malfunction.
- Never mount a product in a location that will be used as a foothold.
The product may be damaged if excessive force is applied by stepping or climbing onto it.

*Wiring

- Do not pull the lead wires.
In particular, never lift a Controller equipped with fitting and piping by holding the lead wires.
Otherwise damage to the internal parts can result, causing malfunction or to be off the connector.
- Avoid repeatedly bending or stretching the lead wire, or placing heavy load on them.
Repetitive bending stress or tensile stress can cause the sheath of the wire to peel off, or breakage of the wire.
If the lead wire can move, fix it near the body of the product.
The recommended bend radius of the lead wire is 6 times the outside diameter of the sheath, or 33 times the outside diameter of the insulation material, whichever is larger.
Replace the damaged lead wire with a new one.
- Wire correctly.
Incorrect wiring can break the Controller.
- Do not perform wiring while the power is on.
Otherwise damage to the internal parts can result, causing malfunction.

- Do not route wires and cables together with power or high voltage cables.
Otherwise the product can malfunction due to interference of noise and surge voltage from power and high voltage cables to the signal line. Route the wires (piping) of the product separately from power or high voltage cables.
- Confirm proper insulation of wiring.
Poor insulation (interference from another circuit, poor insulation between terminals, etc.) can lead to excess voltage or current being applied to the product, causing damage.
- Design the system to prevent reverse current when the product is forced to operate for operational check.
Depending on the circuit used, insulation may not be maintained when operation is forced, allowing reverse current to flow, which can cause malfunction and damage the product.
- Keep wiring as short as possible to prevent interference from electromagnetic noise and surge voltage.
Do not use a cable longer than 30 m.
Wire the DC(-) line(blue) as close as possible to the power supply.

*Environment

- Do not use the product in area that is exposed to corrosive gases, chemicals, sea water, water or steam.
Otherwise failure or malfunction can result.
- Do not use in a place where the product could be splashed by oil or chemicals.
If the product is to be used in an environment containing oils or chemicals such as coolant or cleaning solvent, even for a short time, it may be adversely affected (damage, malfunction, or hardening of the lead wires)
- Do not use in an area where surges are generated.
If there is equipment which generates a large amount of surge (solenoid type lifter, high frequency induction furnace, motor, etc.) close to the Controller, this may cause deterioration or breakage of the internal circuit of the Pressure switch. Avoid sources of surge generation and crossed lines.
- Do not use a load which generates surge voltage.
When a surge-generating load such as a relay or solenoid is driven directly, use a Pressure switch with a built-in surge absorbing element.
- The product is CE marked, but not immune to lightning strikes. Take measures against lightning strikes in the system.
- Mount the product in a place that is not exposed to vibration or impact.
Otherwise failure or malfunction can result.
- Prevent foreign matter such as remnant of wires from entering the pressure switch.
Take proper measures for the remnant not to enter the Controller in order to prevent failure or malfunction.
- Do not use the product in an environment that is exposed to temperature cycle.
Heat cycles other than ordinary changes in temperature can adversely affect the inside of the product.
- Do not expose the product to direct sunlight.
If using in a location directly exposed to sunlight, shade the product from the sunlight.
Otherwise failure or malfunction can result.
- Keep within the ambient temperatures
The fluid and ambient temperatures is 0 to 50 °C.
Avoid sudden temperature change even within specified temperature.
- Do not operate close to a heat source, or in a location exposed to radiant heat.
Otherwise malfunction can result.

*Adjustment and Operation

- Turn the power on after connecting a load.
Otherwise it can cause excess current causing instantaneous breakage of the Controller.
- Do not short-circuit the load.
Although error is displayed when the Controller load is short circuit, generated excess current lead to cause the damage of the Controller.
- Do not press the setting buttons with a sharp pointed object.
It may damage the setting buttons.

- If using the product to detect very small pressure rates, warm up the product for 20 to 30 minutes first.
There will be a drift on the display of approximate 1% immediately after the power supply is turned on.
- Perform settings suitable for the operating conditions.
Incorrect setting can cause operation failure.
For details of each setting, refer to page 19 to 28 of this manual.
- Do not touch the LCD during operation.
The display can vary due to static electricity.

***Maintenance**

- Turn off the power supply, stop the supplied air, exhaust the residual pressure and verify the release of air before performing maintenance.
There is a risk of unexpected malfunction.
- Perform regular maintenance and inspections.
There is a risk of unexpected malfunction.
- Perform drainage regularly.
If condensate enters the secondary side, it can cause operating failure of pneumatic equipment.
- Do not use solvents such as benzene, thinner etc. to clean the Controller.
They could damage the surface of the body and erase the markings on the body.
Use a soft cloth to remove stains. For heavy stains, use a cloth soaked with diluted neutral detergent and fully squeezed, then wipe up the stains again with a dry cloth.

Model Indication and How to Order

PSE20□ - □□□

Input/Output Specifications

Model	Contents
0	NPN open collector 5 outputs + Auto-shift Input
1	PNP open collector 5 outputs + Auto-shift Input

Option 2

Model	Contents
Nil	No option
4C	Connector for sensor lead wire (4 pcs.)

Option 1

Model	Contents
Nil	No option
A	Panel mount adapter
B	Panel mount adapter + Front protective cover

Unit Specifications

Model	Contents
Nil	With unit conversion function *1
M	Fixed SI unit *2

*1: The new Measurement Law prohibits the use of pressure switch with the unit conversion function in Japan.
A unit label is attached.

*2: Fixed unit
for compound, vacuum, low pressure: kPa
for positive pressure: MPa

○Option/Part number

Description	Part number	Note
Power and output lead wire	ZS-26-A	Length 2 m
Connector for sensor lead wire	ZS-28-C	1 pc.
Panel mount adapter	ZS-26-B	With set screw M3x8 L (2 pcs.) and waterproof seal
Panel mount adapter + Front protective cover	ZS-26-C	With set screw M3x8 L (2 pcs.) and waterproof seal
Front protective cover	ZS-26-01	-
□48 conversion adapter	ZS-26-D	It is an adapter for attaching PSE200 series in the panel cut size of PSE100 series.

Summary of Product parts

Names of individual parts

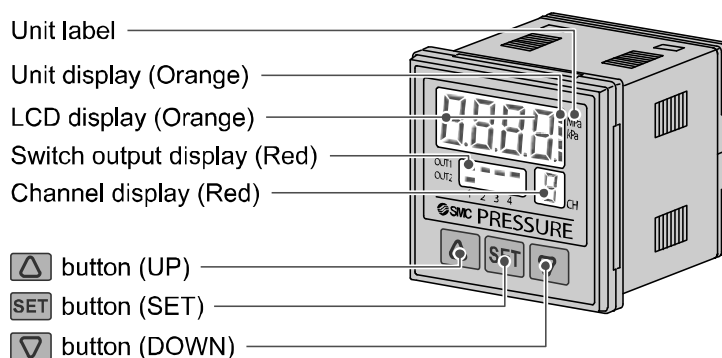

Switch output display (Red): Lit when OUT1 (CH1 to CH4) and/or OUT2 (only CH1) is ON.

LCD display (Orange): Displays the current status of pressure, setting mode, selected indication unit and error code.

▲ button (UP): Selects a mode and increases a set ON/OFF value.

▼ button (DOWN): Selects a mode and decreases a set ON/OFF value.

SET button (SET): Changes the mode and sets a set value.

Unit display (Orange): Lit ON the indicator of selected unit. For the Controller without unit selection function, the unit is fixed to SI (MPa or kPa).

Unit label: Attach the unit label (kgf/cm², bar, psi, inHg, mmHg) with a unit selection function.

Channel display (Red): Indicate the CH1 to CH4 that is selected at that time.

■ Definition and terminology

	Terms	Meaning
7	7-segment indication	When "8" is shown on the display. It is called 7-segment because 8 consists of 7 pieces of "-" (segments)".
A	Auto preset	A function of the Pressure switch to automatically setup pressure just by having equipment hold and release a workpiece via vacuum adsorption. This function is used in an application where vacuum adsorption of a workpiece needs to be confirmed with a Pressure switch.
	Auto shift	A function to correct the set value of the switch output in accordance with the applied pressure in case the switch operation is unstable due to pulsation of applied pressure. This function is used in applications such as vacuum adsorption. The pressure when a signal is externally input is set as a reference value with which the pressure that turns the switch on or off can be shifted.
	Automatic identification function	This function is enabled only when all connected sensors are PSE530 series. (If just one is a different sensor, malfunction can result.) The pressure range of the connected sensor is automatically identified and set.
B	Bottom value indication (mode)	Shows the minimum pressure reached at that moment.
C	Channel scan (function)	The function to display the displayed values from CH1 to CH4 in order every two seconds.
	Chattering	The phenomenon caused in the switch output type in which the output turns on and off repeatedly at high frequency.
	Chattering-preventing function	A function to delay the response time of switch output in order to prevent chattering.
	Copy between channels	The function to copy the settings of any channel (pressure and other initial setting items) to other channels. If the copy is performed from a one output channel (= CH2, CH3 and CH4) to a two output channel (= CH1), it will not be applied to the setting of the second output of the two output channel.
D	Digit (Min. setting unit)	Shows how precisely the pressure can be indicated or set by the digital Pressure switch. When 1 digit = 1 kPa, the pressure is given with an increment of 1 kPa, e.g., 1, 2, 3, ..., 99, 100.
E	Direct output	One of the switch output types, and means the operation in which a switch is turned on when pressure equal to the switch output set value or less is detected. In the (hysteresis mode) window comparator mode, it indicates the operation in which a switch is turned on when pressure outside the switch output range (n1L to n1H or n2L to n2H) is detected. (Refer to "List of output mode" on page 21.)
	Error indication	With the self-diagnosis function given to the Pressure switch, it indicates that there is a failure which could cause a switch failure.

	Terms	Meaning
F	Fine adjustment mode	Refer to "Fine adjustment of indicated value".
	Fine adjustment of indicated value (function)	An indicated pressure value can be adjusted within the range of $\pm 5\%$ R.D. ($\pm 5\%$ of the indicated value). It is used if a true pressure value is known or to correct the difference of an indicated value of the measurement equipment nearby that measures the same pressure as the Pressure switch.
	F.S. (full span/full scale)	Abbreviation for full span and full scale; means the maximum fluctuation range of the Pressure switch rated value. For example, when the output voltage is 1 to 5[V], the F.S. will be $5-1 = 4$ [V]. (Reference: $1\%F.S. = 4 \times 0.01 = 0.04$ [V])
H	Hysteresis	Difference between the points at which the Pressure switch is turned on and off.
I	Indication accuracy	Shows the deviation between displayed pressure value and the true pressure.
	Indication light	The light that turns on when the switch output is on.
	Indication resolution	How fine the rated pressure range can be segmented. (Example: If a product for 0 to 1 MPa can indicate pressure by 0.001 MPa, the indication resolution is 1/1000.)
	Indication unit	The unit of pressure used in the display.
	Initial setting (mode)	The mode to set the items other than pressure. Pressure range, display color, operation mode, output format, response time and auto-preset can be set.
	Insulation resistance	Insulation resistance of a product itself. The resistance between an electric circuit and a body.
K	Key lock (function)	Prohibits a change in the setting of the Pressure switch (locks button operation).
M	Manual setup	Manual pressure setup without using auto preset. This term is used to discriminate from the pressure setup using auto preset.
	Max. applied voltage	The maximum value of applied voltage available to the output line of the NPN output.
	Max. load current	The maximum current available to the output (output line) of the switch output.
	Measurement mode	The condition in which the pressure is being detected and indicated and switch operation is enabled.
	Min. setting unit	Refer to "digit".
N	NPN (open collector) (output)	The switch that uses the NPN transistor for output.
O	Operating mode	There are two choices, hysteresis mode and window comparator mode.
	Output style	The operation theory of the switch output. Either normal output or reversed output can be selected. Refer to "List of output mode" on page 21 for the operation status.
P	Peak value indication (mode)	Shows the maximum pressure reached at that moment.
	PNP (open collector) (output)	The switch that uses the PNP transistor for output.
	Pressure setting	The setting of pressure to determine the point at which the Pressure switch turns on and off.

	Terms	Meaning
R	Rated pressure range	The pressure range in which the Pressure switch satisfies the specifications. Values over this range can be set if they are within the set pressure range, but cannot assured the specifications to be satisfied.
	R.D.	The value currently displayed. For example, when the displayed value is 1.000, $\pm 5\%$ R.D. will be ± 0.05 , which is $\pm 5\%$ of 1.000, while for a displayed value of 0.800 it will be 0.04.
	Repeatability	Reproducibility of the displayed value for pressure and ON-OFF output operating point when the pressure changes at a temperature of 25 °C.
	Residual voltage	The difference between the ideal ON voltage and the actual voltage when the switch output is on. It depends on present load current and ideally should be "0".
	Resolution	Refer to "Indication resolution".
	Response time	The elapsed time until the ON-OFF output begins working since the pressure supplied for the Pressure switch has reached the set value. Generally, the shorter response time is, the better the performance is.
	Reversed output	One of the switch output types, and means the operation in which a switch is turned on when pressure equal to the switch output set value or less is detected. In the (hysteresis mode) window comparator mode, it indicates the operation in which a switch is turned on when pressure outside the switch output range (n1L to n1H or n2L to n2H) is detected. (Refer to "List of output mode" on page 21.)
	Ripple	A type of chattering.
S	Sampling cycle	The frequency in which the detected pressure should be reflected to the digital indication.
	Sensor input	The part to which the output of the separate sensing part is connected.
	Setting of function	Refer to "initial setting (mode)".
	Setting pressure range	The pressure range within which switch output can be set.
	Special setting	Sets items other than pressure and initial setting items. Sets the displayed value fine adjustment, copying between channels, auto-shift and automatic identification function.
	Switch output	Alternatively called "ON-OFF output".
U	Unit conversion function	Function to change the unit in which the value of pressure is indicated. Only a product with this function can change the unit. A product with unit-changing function cannot be purchased if it is used within Japan. Pressure is indicated only by SI units in Japan.
W	Window comparator mode	An output type that holds the output when the pressure is within a certain range. (Refer to "List of output mode" on page 21.)
	Withstand voltage	Durability to voltage applied between an electric circuit and a body. A product's durability in withstanding voltage. If more voltage is applied to the product, the product may be broken. (Voltage mentioned here is not power voltage to activate the product.)
Z	Zero clear (function)	Adjusts the displayed pressure value to "0".

Mounting and Installation

■ Installation

○ Mounting by panel mount adapter

- Fix the panel mount adapter to the Controller with the set screws M3×8 L (2 pcs.) as attached.
- Panel mount adapter (Model: ZS-26-B)
- Panel mount adapter + Front protective cover (Model: ZS-26-01)
- 48 conversion adapter (Model: ZS-26-D)

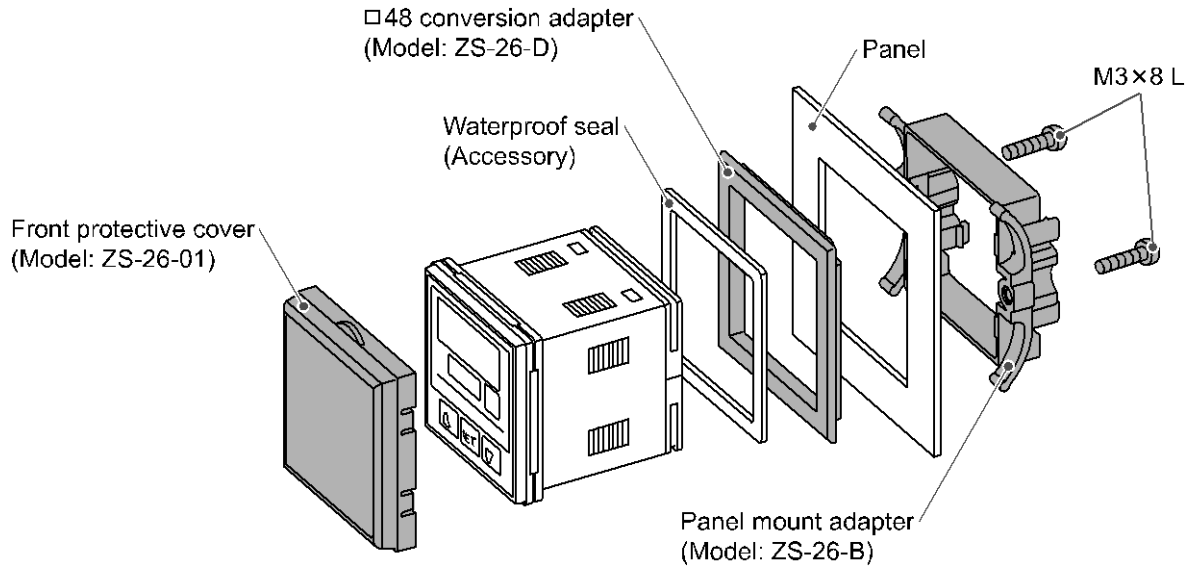

*: The panel mount adapter can be rotated by 90 degrees for mounting.

*: Front panel of this Controller meets IP65 (if □48 conversion adapter is used, it meets IP40). However, if the panel mount adapter is hold enough with screw and the instrument is not seated correctly, water might enter. Screw shall be tightened 1/4 to 1/2 turns more after touched correctly.

○ Panel cutout dimension

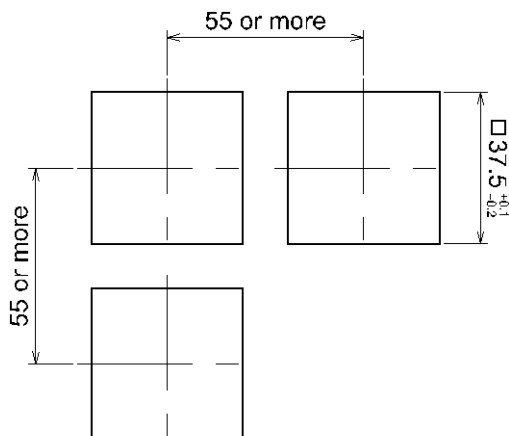

*: Panel thickness 0.5 to 8 mm

Notice when removing to the controller

- The Controller with the panel mount adapter can be removed from facility after removing two screws as shown in a figure, by making insert the suitable thin card for the hook of both the sides, pull a panel mount adapter to the front, and remove it. If panel mount adapter is drawn forward with hook caught, the adapter and Controller may be damaged.

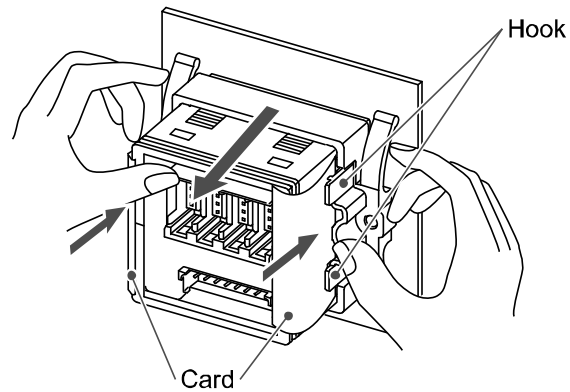

■Wiring

○Connection

- Connections should only be made with the power supply turned off.
- Use separate routes for the Multi Channel Pressure Sensor Controller wiring and any power or high voltage wiring. Otherwise, malfunction may result due to noise.
- Ensure that the FG terminal is connected to ground when using a commercially available switch-mode power supply.

○Attaching the connector to the lead wire

- Sensor wire is stripped as shown in the right figure.
(Refer to the table below for correspondence between connector and electrical wire gauge.)

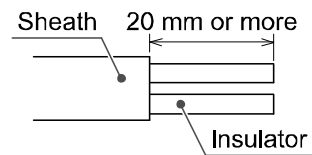

Lead wire table

AWG No.	Conductor size (mm ²)	Overall diameter (mm)	Color of cover	SMC product No. (1 pc.)
26-24	0.14-0.2	φ0.8 to φ1.0	Red	ZS-28-C
		φ1.0 to φ1.2	Yellow	ZS-28-C-1
		φ1.2 to φ1.6	Orange	ZS-28-C-2
22-20	0.3-0.5	φ1.0 to φ1.2	Green	ZS-28-C-3
		φ1.2 to φ1.6	Blue	ZS-28-C-4
		φ1.6 to φ2.0	Gray	ZS-28-C-5

- Do not cut the insulator.
- The core of the corresponding color shown in the following table is put into the pin of the number stamped on the connector for sensor connection to the back.

Pin No.	Wire color
1	Brown (DC+)
2	NC
3	Blue (DC-)
4	Black (IN: 1 to 5 V)

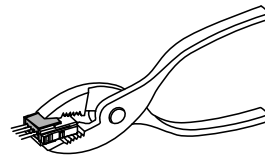
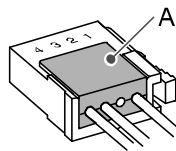

- It checks that the above-mentioned preparation work has been performed correctly, and A part shown in right figure is pushed by hand and makes temporary connection.
- A part center is straightly pushed in by tools, such as pliers.
- Re-use cannot be performed once it connects the connector for sensor connection completely. When you fail in the connection mistake of a core and a pin, or the plug of wire, please use the new connector for sensor connection.
- When the sensor is not connected correctly, [-----] or [---] can be displayed.

○Connector

Connecting/Disconnecting

- When connecting the connector, insert it straight onto the pin and lock the connector into the square groove in the housing until connector clicks.
- When removing the connector, press down the lever with your thumb and pull the connector straight out.

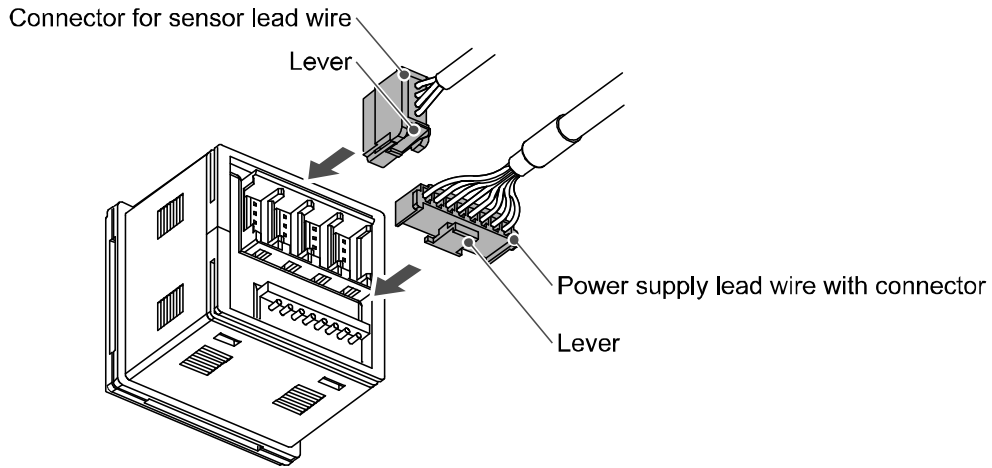

Pin No. of the connector

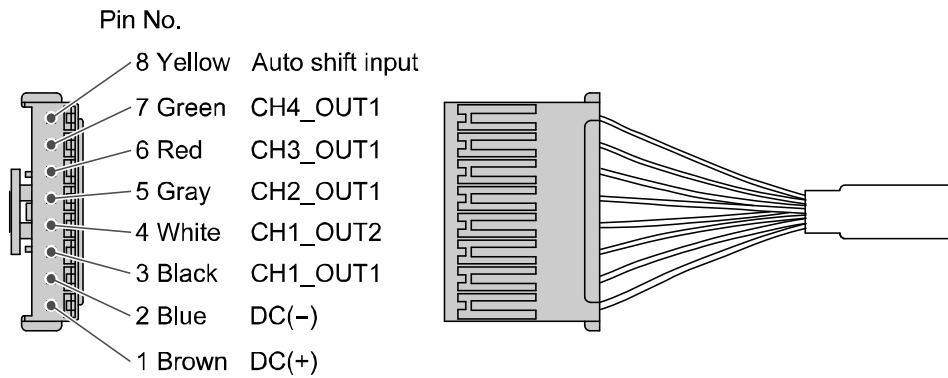

■ Internal circuit and wiring example

○ Output specification

When the lead wire with SMC power and output lead wire (Model: ZS-26-A) is used, the colors of wire (Brown, Blue, White, Gray, Red, Green Yellow) will apply as shown on circuit diagram.

PSE200-(M) □: NPN open collector 5 outputs + Auto-shift 1 input
 Max. 30 V, 80 mA
 Residual voltage 1 V or less

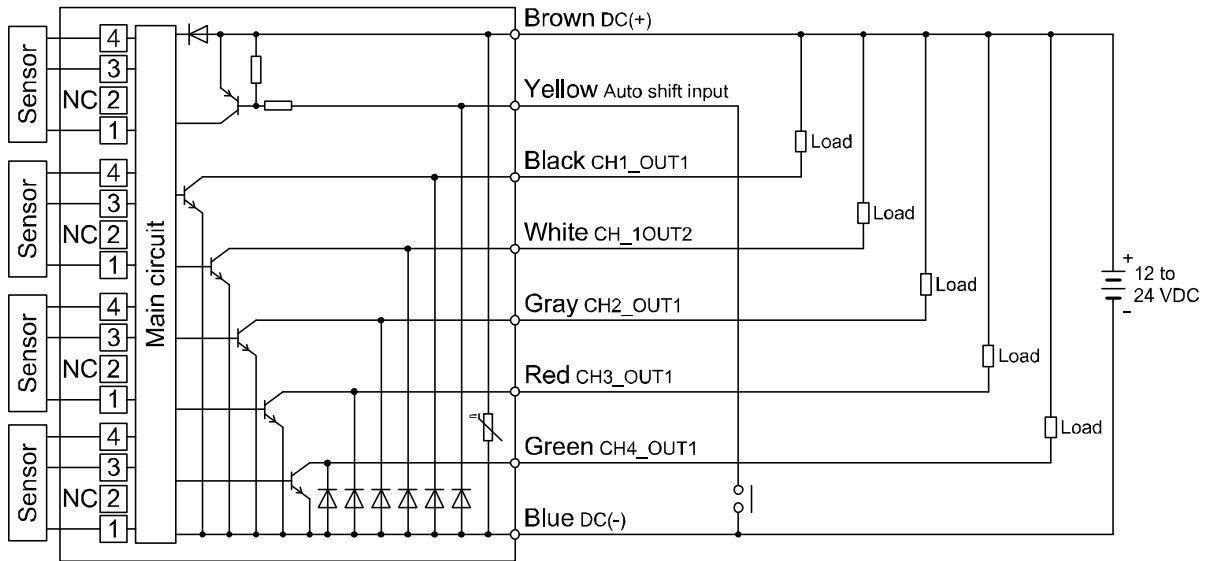

PSE201-(M) □: PNP open collector 5 outputs + Auto-shift 1 input
 Max. 80 mA
 Residual voltage 1 V or less

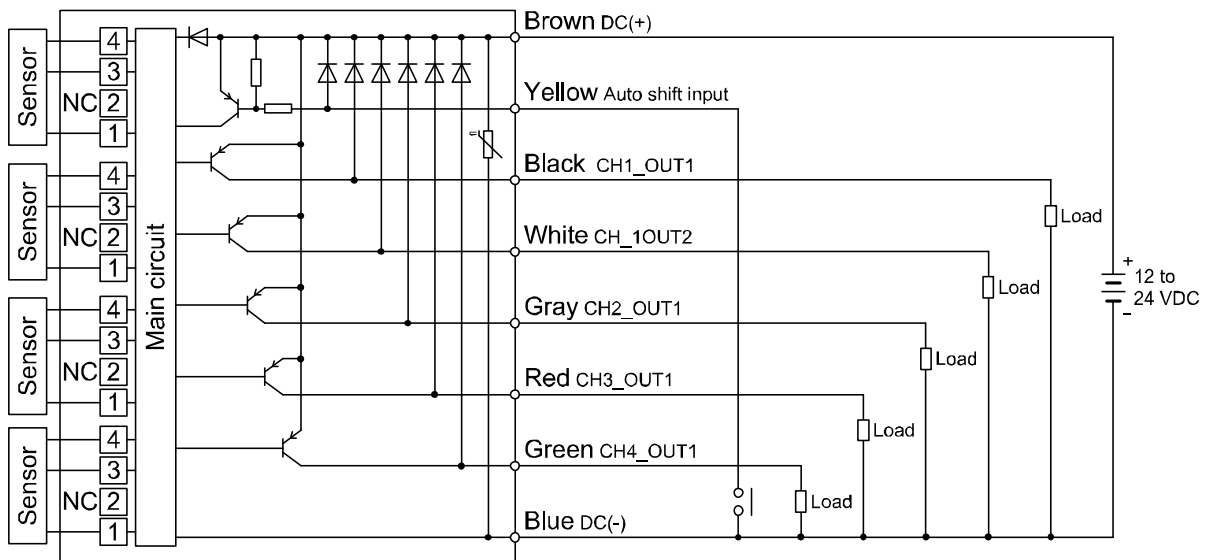

Setting of Function

○Setting procedures

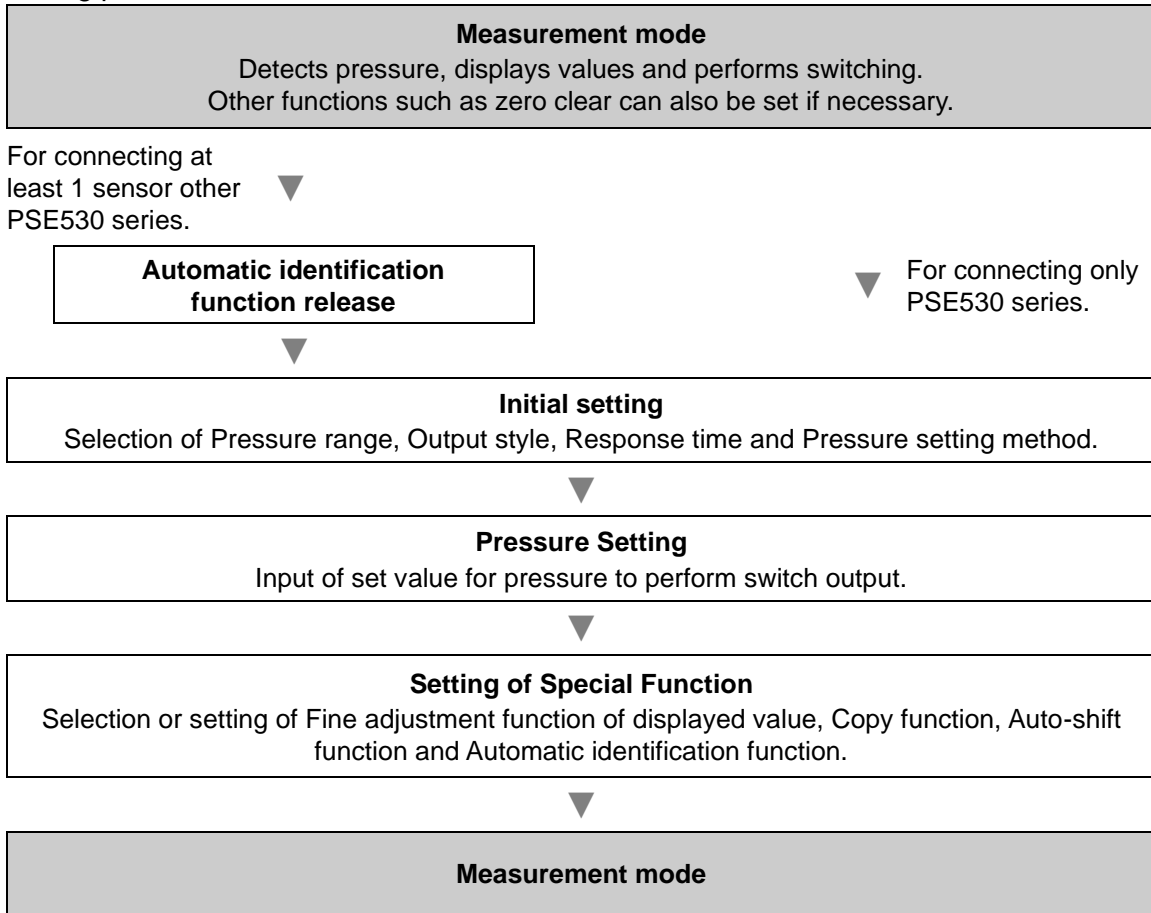

○Automatic identification function release

(When at least 1 sensor other than PSE530 series will be connected.)

- Press the and buttons are pressed simultaneously for 2 seconds or longer to display [FSt].
- Press the button to display [CPy].
- Press the button to display [SH1], and then press the button again.
- If [Aon] is displayed, press the or button to display [AoF], and then press the button.

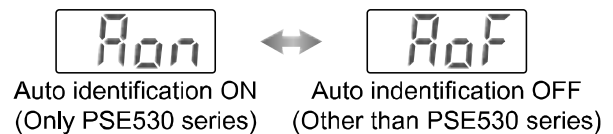

*: Setting for the automatic identification function is ON when default setting.

○ Initial setting

Select the setting channel by pressing the button and keep pressing the button for 2 seconds or longer. Initialize can get started. Initial setting is required for each channel.

1, Setting of pressure range

- Select the pressure range suitable for the sensor connected.
- Press the or button and select the pressure range. Press the button to set.

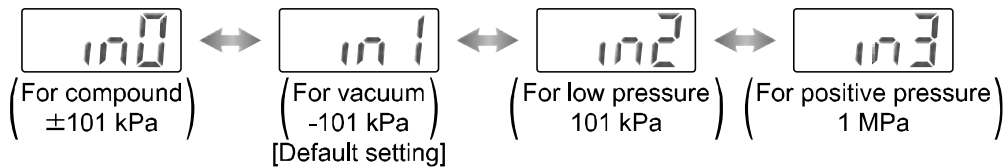

- *: When automatic identification mode is set, it is changed to pressure range of connected pressure sensor (Series PSE530 only) when power is supplied.
- *: When range setting is changed, pressure set value changes. So conduct pressure setting again.

2, Selection of display unit (with unit conversion function)

The indication unit can be selected freely.
 Press the or button will change the unit and will automatically convert set values.
 Press the button to set and to move to setting the output mode.

LCD display		PR	GF	BAR	PSI	INH	MMH
Unit label	For compound and vacuum	kPa	kgf/cm ²	bar	psi	inHg	mmHg
	For low pressure	kPa	kgf/cm ²	bar	psi		
	For positive	MPa	kgf/cm ²	bar	psi		

In order to display the selected unit, the unit label according to the pressure range or the display unit is attached.

Select and use an applicable label from the following table.

- In case [M] is assigned to unit specification in model indication.
 Use the suitable label in the above labels by setup of the display unit.
- In case [M] is not assigned to unit specification in model indication.
 The following unit displays light according to the setting of the pressure range.

LCD display	in0 (Compound)	in1 (Vacuum)	in2 (Low pressure)	in3 (Positive pressure)
Unit display	kPa			MPa

3, Setting of output style

1) The output style for OUT1 is set.

- Press or button and select the normally open or the normally closed.
 Next, press the button to set.

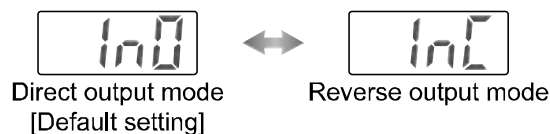

2) The operating mode and the output style for OUT2 is set. (only CH1)

- Press or button and the button to set, as in OUT1.

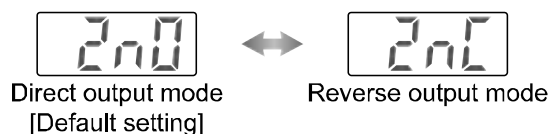

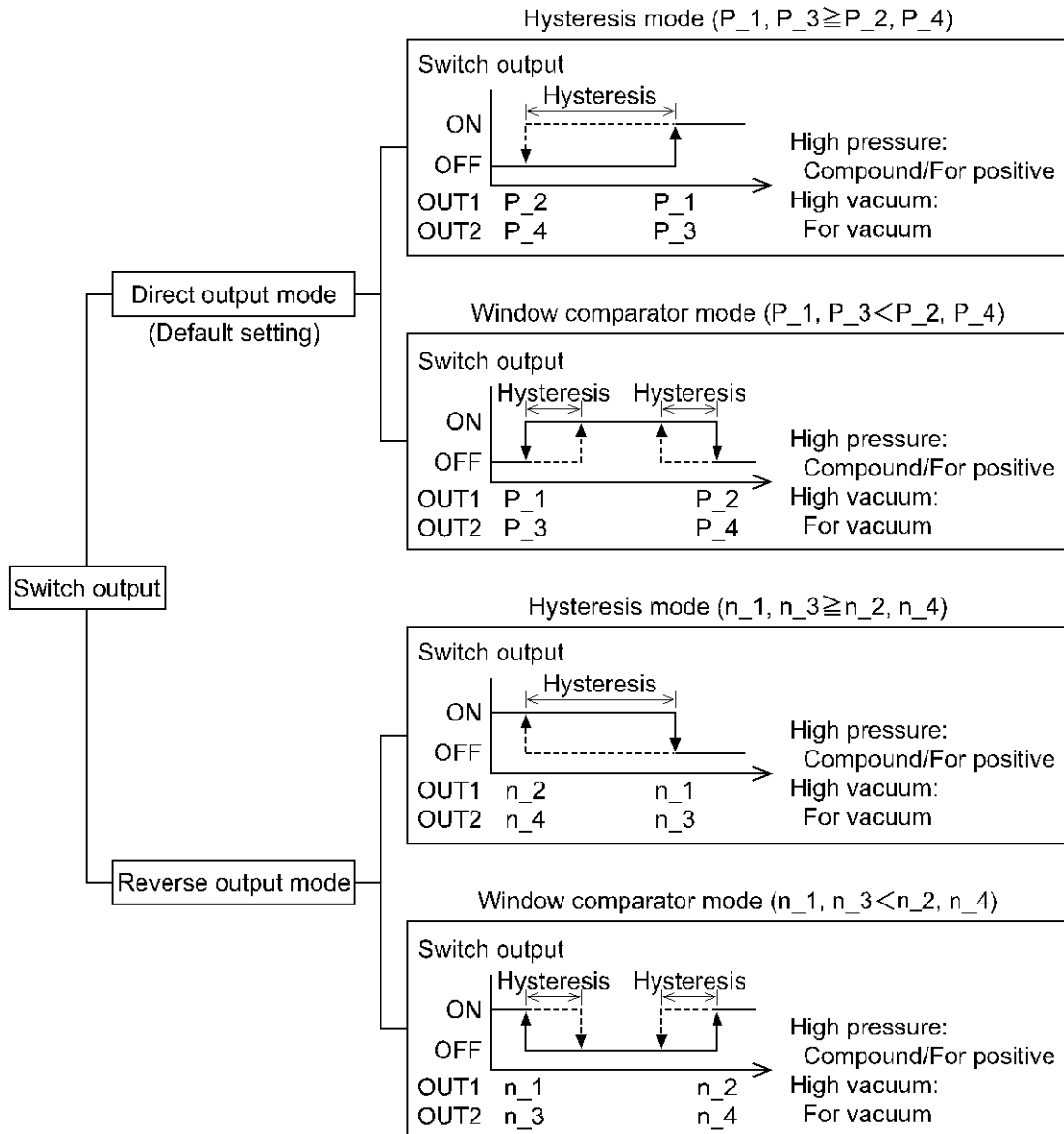

•List of output mode



- If input pressure fluctuates around the set point when hysteresis is set at 2 digits or less in hysteresis mode, switch output may cause chattering.
- Hysteresis is fixed at 3 digits in window comparator mode. When the pressure is set, the space of 7 digits at min. needs to be taken.
→The space below 7 digits does not allow the operation.

4, Setting of response time

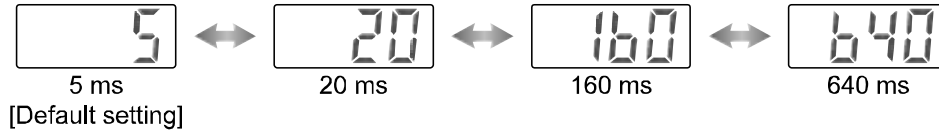

- Set response time of switch output. Output chattering is prevented by setting the response time.
- Press the  or  button to select response time. Press the  button to set.

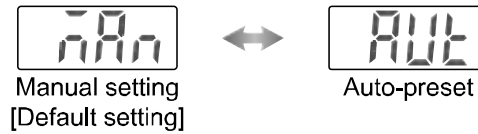

5, Selection of pressure setting method

- There are two methods for pressure setting: manual and auto-preset, either one of which can be selected. The auto-preset is provided for an automatic optimum set-up by using a sample for a case in which switch output is used to check absorption.



- Press the  or  button to select pressure setting method. Press the  button to set.
- All the setting mode will be completed and return to the measurement mode.

Pressure Setting





Manual setting

Manually set a set value of the controller. Pressure setting is made for respective channel.

1, Selection of OUT1 [P_1] setting mode

- Press the  button during the Measurement mode to select channel, and then, press the **SET** button to display set values.







- [P_1] or [n_1] and set value are displayed in turn.
- Press the  or  button to change the set value. The  button is for increase and the  button is for decrease.

Press the  button once to increase by one figure, and press it continuously to keep set figure increased.

Press the  button once to decrease by one figure, and press it continuously to keep set figure decrease.

- Press the **SET** button to finish the setting.

2, Selection of OUT1 [P_2] setting mode

- [P_2] or [n_2] and set value are displayed in turn.
- Press the  or  button to change the set value. The  button is for increase and the  button is for decrease.



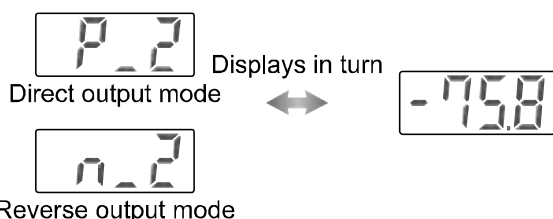

Press the  button once to increase by one figure, and press it continuously to keep set figure increased.

Press the  button once to decrease by one figure, and press it continuously to keep set figure decrease.

- Press the **SET** button to finish the setting.



3, Selection of OUT2 [P_3, P_4] setting mode (only CH1)

- Press the  or  button to change the set value as in 1, 2. The  button is for increase and the  button is for decrease.

Press the  button once to increase by one figure, and press it continuously to keep set figure increased.

Press the  button once to decrease by one figure, and press it continuously to keep set figure decrease.

- Press the **SET** button to finish the setting.

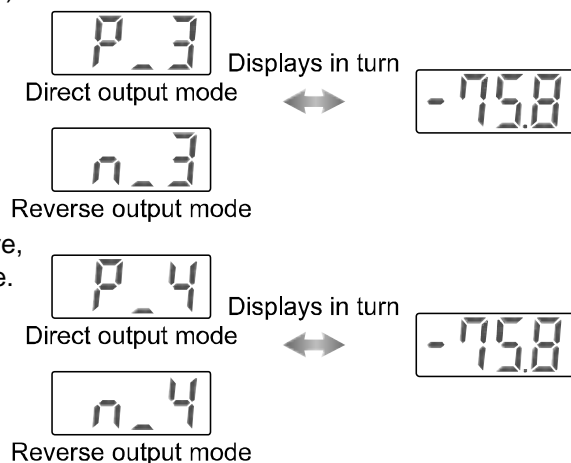

4, Auto-shift compensation value setting

- [C_5] ([C_3] for CH2 to CH4) and auto-shift corrected Value will displayed in turn. Without auto-shift input setting, Correction values displays Zero.

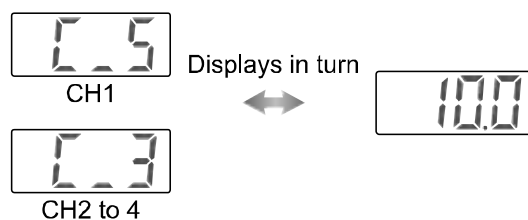

- Press the **SET** button to return to the measurement.



○Auto-preset

When auto-preset is selected in initialize, the set pressure can be calculated and memorized from measured value. The set value is automatically optimized by repeating the suction and release of the object for the setting.

1, Selection of auto-preset OUT1

- Press the  button in Measurement mode to select channel, and then, press the  button to display [AP1].





Auto-preset is ready

2, Preparation of OUT1 device

- Prepare the device for which the pressure of OUT1 is set.

3, Setting of auto-preset value of OUT1

- Press the  button to display [A1L].
- After measurement starts, operate the device and change the pressure.
- When the pressure change is detected, a set value will appear automatically.
(The  and  buttons are pressed simultaneously for 1 second or longer in case OUT1 setting is not necessary, measurement is stopped and [AP2] will appear.)

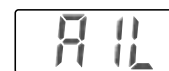

Auto-preset is being set



4, Selection of auto-preset OUT2

- Press the  button to display [AP2].



Auto-preset is ready

5, Preparation and setting of OUT2 device

- Prepare the device for which the pressure of OUT2 is set, and perform the setting of OUT2 in the same manner as that for OUT1.
- After [A2L] is displayed and measurement starts, when the pressure change is detected, a set value will appear automatically.
(The  and  buttons are pressed simultaneously for 1 second or longer in case OUT2 setting is not necessary, measurement mode returns.)



Auto-preset is being set

6, Completion of setting

- Press the  button and complete auto-preset mode. After that, measurement mode returns.

The set value are displayed in auto-preset as follows.

$$\text{ON} = A - (A - B)/4$$

A = Max. pressure

$$\text{OFF} = B + (A - B)/4$$



B = Min. pressure

Setting of Special Function

○Fine adjustment function of displayed value

This makes no dispersion on CH1 to CH4 each output value, and make same displayed value.

It is possible to do fine adjustment within $\pm 5\%$ R.D. range of the reading data on the displayed value of pressure sensor.

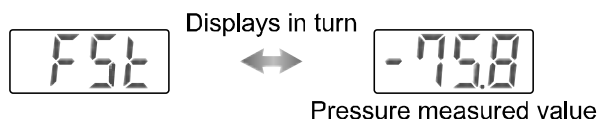

- Press the  and  buttons are pressed simultaneously for 2 seconds or longer to display [FSt].



If fine adjustment is unnecessary, press the  button while [FSt] is displayed. Move to copy function.

- Press the  or  button to select channel, and press the  button.

• [FSt] and preset pressure measured value are in turn.

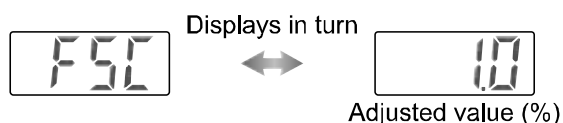

- Increase or decrease value by press the  or  button.



(It is possible to increase/decrease within $\pm 5\%$ R.D.)

- Check the value, then press the  button.

[FSC] and the adjusted value (%) are displayed in turn.

- Press the  button to return display of [FSt]. Perform display of [FSt] setting of other channels like the above by press the  or  button.

- After setting of other channels in [FSt] display is completed, press the  button there. Move to copy function.

*: When fine adjustment mode is conducted, pressure setting value is sometimes changed by ± 1 digit

○Copy function

1, 5 items such as pressure setting value, pressure range, display unit, output style and response time are copied.

2, If copied from CH1 to CH2, CH3 and CH4, CH1 OUT1 information is copied.



CH2, CH3 and CH4 information are copied only into OUT1 of CH1 if copied from CH2, CH3 and CH4 to CH1.

- [CPy] is displayed. Selection of channel to be copied displayed in channel indicator by press the  or  button.

- Press the  button in case copy mode setting is not necessary.



Move to auto-shift function.

- Press the  button so that the channel display of a copied material changes from blink to lighting.

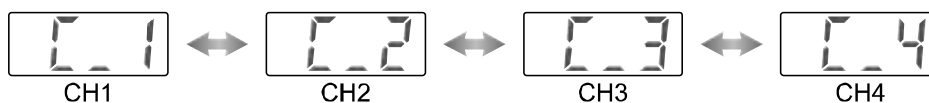
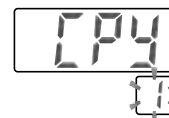
- [CPy] and the channel to be pasted will flicker alternately. Next, select channel to be pasted by press the  or  button.



- Press the  button, and return to [CPy] display.

- Again press the  or  button and the same operation is repeated to copy other channel.

- After setting is completed, move from [CPy] display to auto-shift mode.

*: When copy function is conducted, pressure setting value is sometimes changed by ± 1 digit.

○Auto-shift function

This function corrects the setting value of each switch output according to change of pressure source. Even if pressure source is changed, this can do correct decision on switch output.
Refer to below or page 27 for detail.

- Press the Δ or ∇ button in the state where [SH1] is displayed, and [CH1] and [on]/[oF] will flicker alternately. Press the **SET** button with the indication of [SH1] makes it move to the automatic identification function.

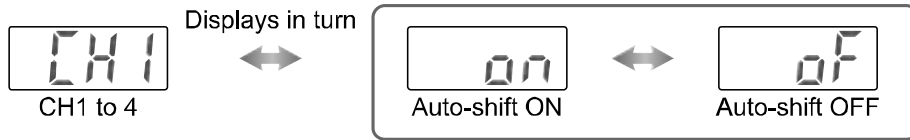

- Selection of auto-shift mode by press the Δ or ∇ button, and press the **SET** button.
- Similarly, [CH2], [CH3] and [CH4] press the Δ or ∇ button, and selection of auto-shift mode.
- After auto-shift mode setting of all channels is completed, if press the **SET** button, it will move to automatic identification function.

○About auto-shift function

This function corrects the setting value of each switch output according to change of pressure source. Even if pressure source is changed, this can do correct decision on switch output.

- Correction of setting value by auto-shift use

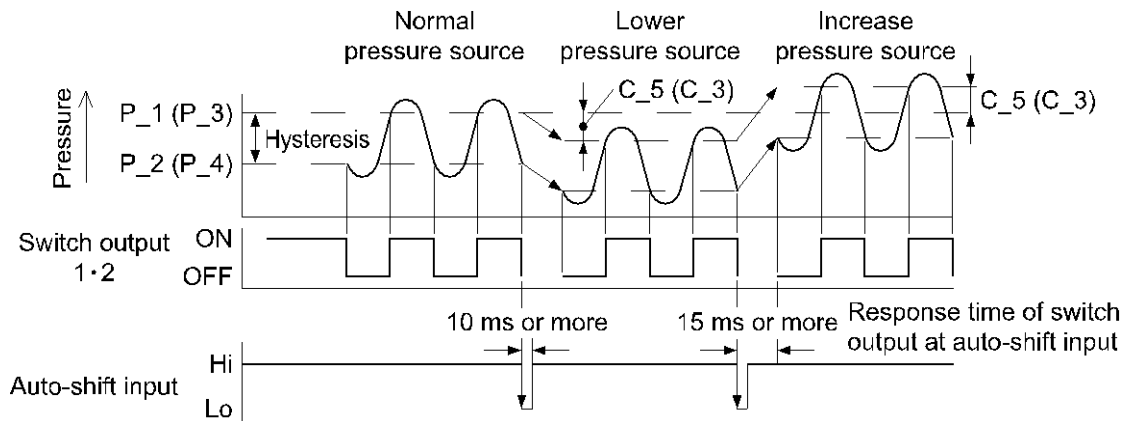

- Using with auto-shift input, accepted setting range is like below



	Pressure range					<div style="display: inline-block; width: 15px; height: 10px; background-color: #cccccc; border: 1px solid black;"></div> Set pressure range <div style="display: inline-block; width: 15px; height: 10px; background-color: #333333; border: 1px solid black;"></div> Accepted set range
	-1 MPa	-100 kPa	0	100 kPa	1 MPa	
For compound		-101 kPa	█	101 kPa		
		-101 kPa	█	101 kPa		
For vacuum		-101 kPa	█	10 kPa		
		-101 kPa	█	10 kPa		
For low pressure		-10 kPa	█	101 kPa		
		-10 kPa	█	101 kPa		
For positive pressure		-100 kPa	█	1 MPa		
		-100 kPa	█	1 MPa		

○Conditions and explanations for auto-shift function

- Keep constant pressure for 10 ms or longer from the close signal of auto-shift input.
- At auto-shift input, [ooo] is displayed for approximate 1 second. Pressure value at that time is memorized as corrected value [C_5] or [C_3].
- The switch set as auto-shift mode at the time of initial setting operates with the value which applied corrected value [C_5] or [C_3] to setting value.
 - CH1 will operate with auto-shift function.
The operate value of OUT1 applies corrected value [C_5] to the setting value [P_1] to [P_4] or [n_1] to [n_4].
 - CH2 to CH4 will operate with auto-shift function
The operate value of OUT1 applies corrected value [C_3] to the setting value [P_1] and [P_2] or [n_1] and [n_2].
- Span is 15 ms or less until the switch output starts soon after auto-shift input.
- When corrected measured value exceed the set pressure range with auto-shift input, the value is changed to be within the range of set pressure.
- When auto-shift function is turned off, corrected value becomes zero.
- When auto-shift function of all channels is turned off, even if auto-shift input is Lo (Non voltage input) does not show [ooo].
- Corrected value after auto-shift input will vanish when the power is off, and is reset to zero (Initial value) when the power is off, and is reset to zero (Initial value) when the power is re-supplied.
*: EEPROM is not used for memory corrected value.

○Automatic identification function

This function identifies pressure range of pressure sensor connected to this controller. When [Aon] is set at the automatic identification mode, and when re-applied power at [Aon] status, this function actuates. (Special pressure sensor (SMC PSE530 series) is applicable to this function. Other pressure sensor is not applicable.)



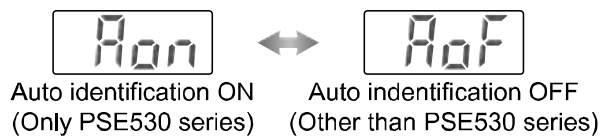

- Press the  or  button to select automatic identification mode, and press the  button.
- All the setting mode will be completed and return to the measurement mode.





Other Settings

○Peak/Bottom hold indication

Maximum and minimum values are always detected and updated during measurement.
Displayed values can be hold.

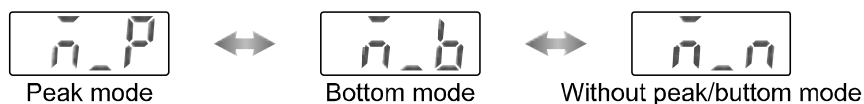
- Press the  button for 2 seconds or longer.
- Press the  or  button to select peak/bottom mode, and press the  button.



- Peak mode: Flickers the maximum pressure value.
- Bottom mode: Flickers the minimum pressure value.
- w/o peak/bottom mode: Return to the measurement mode.
- To release hold, press the  button for 2 seconds or longer, then select [\bar{n}_n] and finally press the  button.
- When each setting or each mode operation is performed, the "Peak and Bottom hold indication" is released.



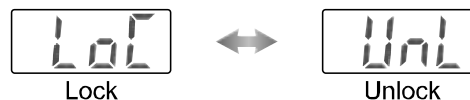

○Key lock function

A wrong operation performed unintentionally such as change of set value can be prevented.





Set [LoC] (lock mode) in order not to accept button operation.



Lock

- Keep press the  button for 4 seconds or longer.
Remove the finger off the button when [UnL] is displayed.
- Press the  to  button to set the display to [LoC].
- Press the  button makes it move to the measurement mode.





Release

- Keep press the  button for 4 seconds or longer.
Remove the finger off the button when [LoC] is displayed.
- Press the  to  button to set the display to [UnL].
- Press the  button makes it move to the measurement mode.

*: For a "Channel selects function" and "Channel scans function", the "Key lock function" does not work.

○Zero clear



A displayed value can be adjusted to zero when the pressure to be measured is within $\pm 5\%$ F.S. ($\pm 2.5\%$ F.S. for compound pressure) of the pressure at the ambient pressure.

- Press continuously the  and  buttons for 1 second or longer simultaneously, display is cleared as "0".
Please press the  button before  button first, channel select function may operate.
- Return to the measurement mode automatically.

○Channel selects

- Per one push  button, channel selection can be done, like "1→2→3→4→1→...".
Display shows pressure value, which is measured at the channel selected.

○Channel scans

- Keep press the  button for 2 seconds or longer. If changes indicating the channel indicated ever 2 seconds and measuring pressure corresponding with it.
- To release this function, press the  button again for 2 seconds or longer.

Maintenance

How to reset the product for power cut or forcible de-energizing

The setting of the product is remained as that before power cut or de-energizing.

The output condition is also basically recovered to that before power cut or de-energizing, but may change depending on the operating environment. Therefore, check the safety of whole facility before operating the product.

If the facility is under accurate control, wait until it has warmed up. (Approximate 20 to 30 minutes)

Troubleshooting

○Troubleshooting

Applicable pressure switch: **PSE200**

If a cause applicable to the failure cannot be identified and normal operation can be recovered by replacement with a new Pressure switch, this indicates that the Pressure switch itself was broken. The Pressure switch breakage can be caused by operating environment (network construction, etc.), and so consult with SMC separately to obtain countermeasures.

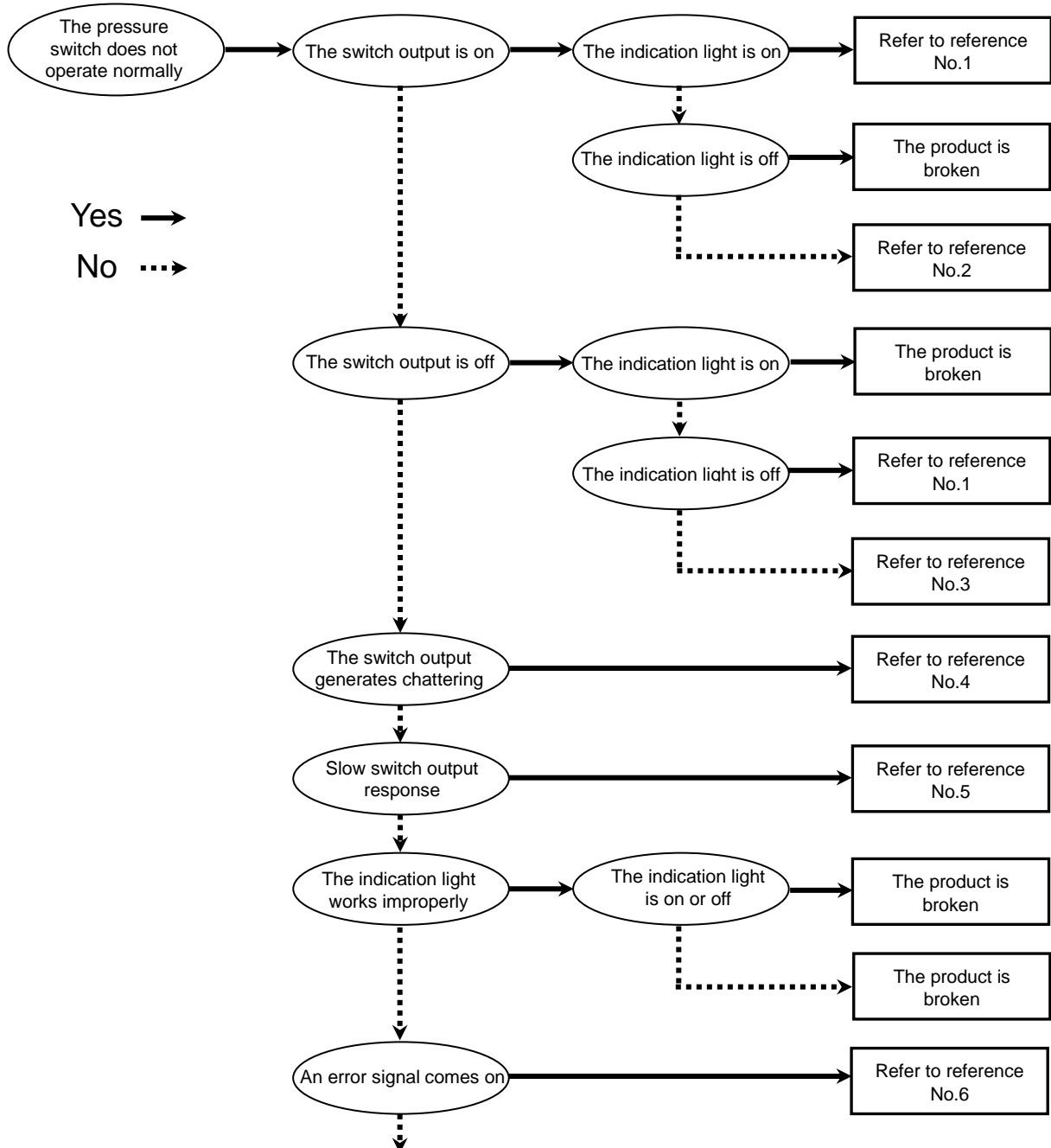

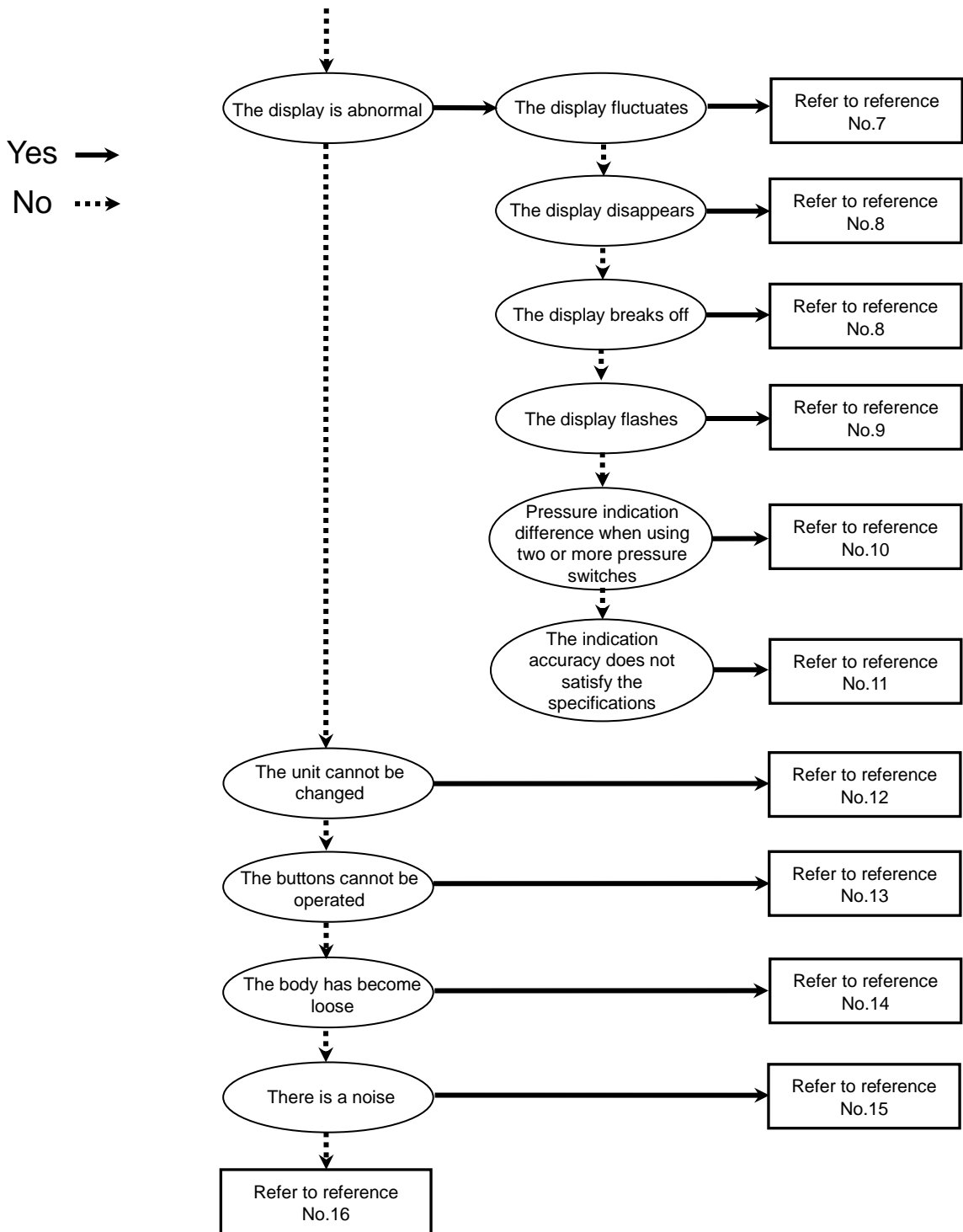

○Cross-reference for troubleshooting

Reference No.	Problem	Possible cause	Investigation method	Countermeasure
1	<ul style="list-style-type: none"> ●Output remains on. Indication light remains on. ●Output remains off. Indication light remains off. 	Wrong pressure setting	(1)Check the set pressure. (2)Check the settings of the operation mode, hysteresis and output style. (Hysteresis mode/window comparator mode, normal output/reversed output)	(1)Reset the pressure setting. (2)Reset the setting of function.
		Product failure		Replace the product.
2	Output remains on. Indication light works correctly.	Incorrect wiring	Check the wiring of the output line. Check if the load is connected directly to DC(+) or DC(-).	Correct the wiring.
		Product failure		Replace the product.
3	Output remains off. Indication light works correctly.	Incorrect wiring	Check the wiring of the output line. Check if the load is connected directly to DC(+) or DC(-).	Correct the wiring.
		Unsuitable model selection	Check if PNP is used even though NPN should have been selected, or the other way around.	Review the selected model (output type).
		Lead wire breakage	Check if there is bending stress applied to any parts of the lead wire. (Bending radius and tensile force applied to the lead wire)	Correct the wiring conditions. (Adjust the tensile force and widen the bending radius.)
		Product failure		Replace the product.
4	Switch output generates chattering.	Incorrect wiring	Check the wiring. Check if the brown and blue wires are connected to DC(+) and DC(-) respectively, and if the output line is about to come off (contact failure).	Correct the wiring.
		Wrong setting	(1)Check the set pressure. (2)Check if the hysteresis range is too narrow. (3)Check the response time set as initial setting. Check if the response time is too short.	(1)Reset the pressure setting. (2)Widen the hysteresis. (3)Reset the setting of function.
		Product failure		Replace the product.
5	Slow switch output response	Incorrect pressure setting	(1)Check the pressure setting. Check if the detected pressure and the set pressure value have the same value or are too close. (2)Check the response time set as initial setting. Check if the response time is too long.	(1)Reset the pressure setting. Set up the pressure setting value so it is not too close to the detected pressure value. (2)Reset the setting of function.

Reference No.	Problem	Possible cause	Investigation method	Countermeasure
6	<ul style="list-style-type: none"> •An over current error (Er1 and 2) is indicated. •System error (Er5, 6, 7, and 8) is indicated. •The display shows "----". •The display shows "----". •Zero-clear error (Er3) is indicated. 	Over current to the output (Er1 and 2)	(1)Check if a current of 80 mA or more is flowing to the output. (2)Check if the connected load satisfies the specifications, and if the load is shorted. (3)Check if a relay without a surge voltage suppressor is connected. (4)Check if the wiring is in the same route as (or bundled together with) a high-voltage line or the power line.	(1). (2)Connect the load as specified. (3)Use a relay with a surge voltage suppressor or take a measure to prevent noise. (4)Separate the wiring from the high-voltage line and/or power line.
		Improper transaction of the internal data of the Pressure switch (Er5, 6, 7, and 8)	(1)Check if there is noise interference such as static electricity. Check if there is a noise source (2)Check if the power supply voltage is in the range of 12 to 24 VDC.	(1)Remove the noise and the noise source (or take measures to prevent noise interference), and turn off the power supply. Then, supply the power again. (2)Supply power voltage of 12 to 24 VDC.
		Applied pressure is over the upper limit (---).	(1)Check if the pressure gets over the upper limit of the set pressure range. (2)Check if foreign matter got into the piping. (3)The connector for sensor may not be connected correctly.	(1)Bring the pressure back within the set pressure range. (2)Take measures to prevent foreign matter from getting into the piping. (3)Check the wires and contact of the connector for sensor.
		Applied pressure is under the lower limit (----).	(1)Check if the pressure gets below the lower limit of the set pressure range. (2)Check if foreign matter got into the piping. (3)The connector for sensor may not be connected correctly.	(1)Bring the pressure back within the set pressure range. (2)Take measures to prevent foreign matter from getting into the piping. (3)Check the wires and contact of the connector for sensor.
		Pressure is not atmospheric pressure at zero-clear operation (Er3)	Check if the pressure over $\pm 5\%$ F.S. ($\pm 2.5\%$ F.S. for compound pressure) of the atmospheric pressure is applied.	Return the applied pressure to atmospheric pressure, and retry the zero clear operation.
	Product failure		Replace the product.	

Reference No.	Problem	Possible cause	Investigation method	Countermeasure
7	Indicated values fluctuate.	Incorrect power supply	Check if the power supply voltage is within the range of 12 to 24 VDC.	Supply power supply voltage of 12 to 24 VDC.
		Incorrect wiring	Check the wiring to the power supply. Check if the brown and blue wires are connected to DC(+) and DC(-) respectively and if the output line is about to come off (contact failure).	Correct the wiring.
8	•Indicator turns off.	Incorrect power supply	Check if the power supply voltage is within the range of 12 to 24 VDC.	Supply power supply voltage of 12 to 24 VDC.
	•A part of the indication misses.	Power saving mode	Check if the power saving mode is selected.	Reset the setting of function.
		Product failure		Replace the product.
9	Indicator is blinking.	The peak value/bottom value indication mode is selected.	Check if the peek value or bottom value indicating mode is selected.	Turn off the peak value/bottom value indication mode.
		Wiring failure	(1)Check the power supply wiring. (2)Check if bending stress is being applied to a specific part of the lead wire.	(1)Correct the wiring. (2)Correct the wiring (bending radius and stress).
10	Pressure indication difference when using two or more Pressure switches.	Dispersion within the indication accuracy range	Check if the dispersion is within the indication accuracy range.	Use the fine adjustment mode to adjust the indication if the dispersion is within the indication accuracy range.
		Product failure		Replace the product.
11	The pressure indication accuracy does not satisfy the specifications.	Foreign matter	Check if foreign matter has entered the pressure port.	Install a 5 μm filter to prevent foreign matter from getting into the pressure port. Also, clean the filter regularly to prevent drainage deposits.
		Air and liquid leakage	Check if air and liquid are leaking from the piping.	Rework the piping. If excessive tightening torque over the specified range is applied, a mounting screw, mounting bracket, and product may be broken.
		Insufficient warm-up	Check if the product satisfies the specified accuracy 20 minutes after supplying power.	After energizing, indication can drift. For detecting fine pressure, warm up the product for 20 to 30 minutes.
		Product failure		Replace the product.

Reference No.	Problem	Possible cause	Investigation method	Countermeasure
12	The unit cannot be changed.	Improper model selection (Selection of model "without unit conversion function")	Check if there is a "-M" at the end of the part number printed on the product	"M" in the part number means that the unit cannot be changed. *: The unit change function is not available in Japan due to a new measurement law. *: It is fixed to the SI unit "kPa", "MPa".
		Product failure		Replace the product.
13	The buttons cannot be operated.	Key lock mode	Check if the key lock mode is turned on.	Turn off the key lock mode.
		Product failure		Replace the product.
14	The body is loose.	Incorrect installation	Check that the panel mounting adapter and the body are firmly engaged.	Mount the body on the panel properly.
		Product failure		Replace the product.
15	Noisy.	Air and liquid leakage	Check if air liquid are leaking from the piping.	Rework the piping. If excessive tightening torque over the specified range is applied, a mounting screw, mounting bracket, and product may be broken.
		Product failure		Replace the product.
16	The operation is unstable. (Chattering)	Effect of pressure source fluctuation due to small hysteresis or too early of a response time	(1)Check the set pressure (hysteresis) (2)Check the response time	(1)Check the pressure setting. (2)Reset the setting of function.
		Incorrect wiring/ lead wire breakage	(1)Check the power supply wiring. (2)Check if bending stress is applied to a specific part of the lead wire. (bending radius and tensile force applied to the lead wire)	(1)Correct the wiring (2)Correct the wiring conditions. (Adjust the tensile force and widen the bending radius.)
		Product failure		Replace the product.
	The setting changes.	The automatic identification function is turned on.	Check the setting by the automatic identification function.	Turn off the setting if it is on.
A sensor other than PSE530 is connected.		Check the part number of the sensor.	Turn off the setting if the sensor is not PSE530.	

○Error indication function

This function is to display error location and content when a problem or an error occurs.

Error Name		Error Display	Error Type	Troubleshooting Method
Over current Error	OUT1	Er-1	A load current of switch output is 80 mA or more.	Turn the power off and remove the output factor for the over current. Then turn the power on.
	OUT2	Er-2		
Zero-clear Error		Er-3	During zero clear operation, pressure over $\pm 5\%$ F.S. ($\pm 2.5\%$ F.S for compound pressure) is applied. After 2 s, the mode will reset to the measurement mode.	Perform zero clear operation again after restoring the applied pressure to an atmospheric pressure condition.
Pressurizing Error		---	Pressure has exceeded the upper limit of the set pressure range.	Check connection and wiring of a sensor. And reset applied pressure to a level within the set pressure range.
		----	A sensor has the possibility of un-connecting and miswiring. Pressure has exceeded the lower limit of the set pressure range.	
System Error		Er-5 Er-6 Er-7 Er-8	Displayed in the case of an internal data error.	Turn the power off and turn it on again. If resetting fails, an investigation by SMC CORPORATION will be required.

If the error can not be reset after the above measures are taken, then please contact SMC.

Specification

■ Specifications

Model No.		PSE20*			
Pressure range *1		For positive pressure	For vacuum	For low pressure	For compound
Rated pressure range		0 to 1 MPa	0 to -101 kPa	0 to 101 kPa	-101 to 101 kPa
Set pressure range		-0.1 to 1 MPa	10 to -101 kPa	-10 to 101 kPa	-101 to 101 kPa
Setting/Display resolution		0.1 kPa	0.1 kPa	0.1 kPa	0.001 MPa
Power supply voltage		12 to 24 VDC, ripple (p-p) 10% or less (Protected against inverse connection)			
Current consumption		55 mA or less (Except for consumed current of sensor part)			
Power supply voltage for sensor		[Power supply voltage] -1.5 V			
Power supply current for sensor		Max. 40 mA or less (Max. total consumed current is 100 mA for inputting 4 sensors) *2			
Sensor input	Input signal	1 to 5 VDC (Input impedance: Approx. 800 kΩ)			
	Number of input	4 inputs			
	Input protection	With over voltage protection (Applicable to voltage up to 26.4 V)			
	Automatic identification	Provided *3			
Hysteresis		Hysteresis mode: Variable Window comparator mode: Fixed 3 digits			
Switch output	Output style	NPN or PNP open collector output			
	Number of output	5 outputs (2 outputs for sensor input CH1, and 1 output for each CH2 to CH4)			
	Max. load current	80 mA			
	Max. applied voltage	30 VDC (At NPN output)			
	Residual voltage	1 V or less (At 80 mA load current)			
	Output protection	With short circuit protection			
Response time		5 ms or less			
	Anti-chattering function	20, 160, 640 ms selectable			
Repeatability		±0.1%F.S. ±1 digit			
Indicator accuracy (Ambient temp. 25 °C)		±0.5%F.S. ±1 digit			
Display method		Display for measured value: 4 digits, 7-segment (Orange) Display for channel: 1 digit, 7-segment (Red)			
Indicator		Light when ON (Red)			
Auto-shift input		Non-voltage input (Reed or solid state), Input 10 ms or less, Setting ON/OFF is possible independently			
Environment	Enclosure	Front part: IP65 (At panel mounting), Others: IP40			
	Ambient temp. range	Operation: 0 to 50 °C, Storage: -10 to 60 °C (No condensation or freezing)			
	Ambient humidity	Operation, Storage: 35 to 85%RH (No condensation)			
	Withstand voltage	1000 VAC, 1 minute Between lead block and case			
	Insulation resistance	50 MΩ or more (At 500 VDC) Between lead block and case			
Temp. characteristics		±0.5%F.S. (25 °C reference)			
Connection		Power supply and output connection: 8P connector, Sensor connection: e-con			
Standard		CE, RoHS			
Power supply/Output connection cable		Oil resistance vinyl cabtyre cable 8 cores φ4.8 2 m Sectional area of conductor: 0.15 mm ² Outside diameter of insulator: 0.9 mm			
Material		Body: PBT, Display: Transparent nylon, Rubber cover for the back: CR			
Weight		113 g (Power supply and output lead wire cable included) 55 g (Power supply and output lead wire cable not included)			

*1: Select pressure range by the initialization.

*2: Over current on Vcc side and 0 V side of sensor input connector results in breakage of internal parts of controller.

*3: Pressure sensor that automatic identification can be applied is only "PSE530 series". Refer to page 19, 27 "Automatic identification function" for detail.

■Dimensions

○Body dimensions

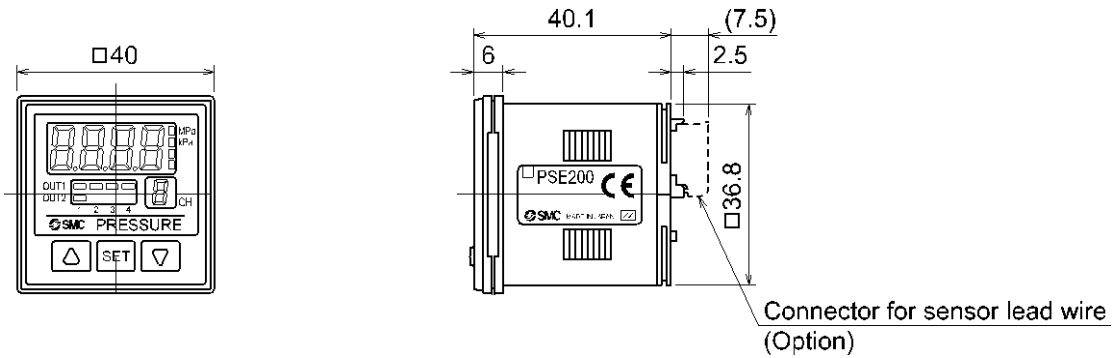

●Panel mount adapter + Front protective cover

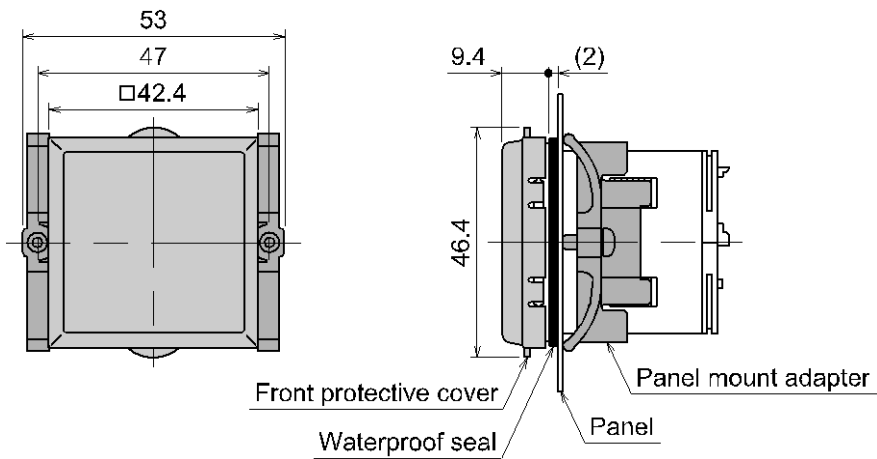

●Panel mount adapter + □48 conversion adapter

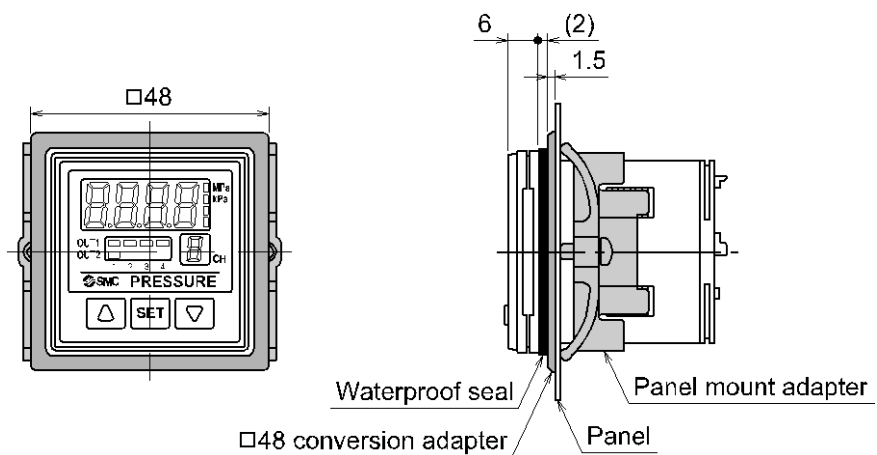

Revision history

- A: Addition of notes related to automatic identification function.
- B: New publication for additional notes.
- C: Revision.
- D: Limited warranty and Disclaimer and measurement laws are added.
- E: Contents revised in several places.
- F: Contents revised in several places. [July 2018]
- G: Contents revised in several places. [May 2024]

SMC Corporation

Tel: + 81 3 5207 8249 Fax: +81 3 5298 5362

URL <https://www.smcworld.com>

Note: Specifications are subject to change without prior notice and any obligation on the part of the manufacturer.
© SMC Corporation All Rights Reserved



No.PS※※-OMH0006-G