



# Operation Manual

PRODUCT NAME

Digital Flow Monitor

MODEL / Series / Product Number

*PFGM3#2*

**SMC Corporation**



## Table of Contents

Safety Instructions	3
Model Indication and How to Order	9
Summary of Product parts	10
Definition and terminology	11
Mounting and Installation	13
Installation	13
Wiring	15
Flow Setting	21
Outline of Settings	22
Initial Setting	23
3 Step Setting Mode	29
Simple Setting Mode	31
Function Selection Mode	32
Function selection mode	32
Default setting	32
F0 Flow range, fluid, display units and switch output specification	34
F 1 Setting of OUT1	39
F 2 Setting of OUT2	44
F 3 Digital filter setting	47
F 4 Auto-preset function setting	48
F 5 FUNC terminal function setting	50
F10 Sub display setting	53
F11 Display resolution setting	55
F14 Display with zero cut-off setting	56
F30 Accumulated value hold setting	58
F80 Power saving mode	59
F81 Security code	60
F90 Setting of all functions	62
F96 Sensor input/External input signal status display	64
F97 Copy setting	65
F98 Output check	68
F99 Reset to default settings	70
Other Settings	71
Maintenance	75
Forgotten the security code	75
Troubleshooting	76
Specifications	84
Characteristics data	86
Dimensions	87



# Safety Instructions

These safety instructions are intended to prevent hazardous situations and/or equipment damage. These instructions indicate the level of potential hazard with the labels of “**Caution**,” “**Warning**” or “**Danger**.” They are all important notes for safety and must be followed in addition to International Standards (ISO/IEC)<sup>\*1)</sup>, and other safety regulations.

\*1) ISO 4414: Pneumatic fluid power - General rules and safety requirements for systems and their components  
ISO 4413: Hydraulic fluid power - General rules and safety requirements for systems and their components  
IEC 60204-1: Safety of machinery - Electrical equipment of machines - Part 1: General requirements  
ISO 10218-1: Robots and robotic devices - Safety requirements for industrial robots - Part 1: Robots  
etc.



## **Danger**

**Danger** indicates a hazard with a high level of risk which, if not avoided, will result in death or serious injury.



## **Warning**

**Warning** indicates a hazard with a medium level of risk which, if not avoided, could result in death or serious injury.



## **Caution**

**Caution** indicates a hazard with a low level of risk which, if not avoided, could result in minor or moderate injury.



## **Warning**

### **1. The compatibility of the product is the responsibility of the person who designs the equipment or decides its specifications.**

Since the product specified here is used under various operating conditions, its compatibility with specific equipment must be decided by the person who designs the equipment or decides its specifications based on necessary analysis and test results. The expected performance and safety assurance of the equipment will be the responsibility of the person who has determined its compatibility with the product. This person should also continuously review all specifications of the product referring to its latest catalog information, with a view to giving due consideration to any possibility of equipment failure when configuring the equipment.

### **2. Only personnel with appropriate training should operate machinery and equipment.**

The product specified here may become unsafe if handled incorrectly. The assembly, operation and maintenance of machines or equipment including our products must be performed by an operator who is appropriately trained and experienced.

### **3. Do not service or attempt to remove product and machinery/equipment until safety is confirmed.**

1. The inspection and maintenance of machinery/equipment should only be performed after measures to prevent falling or runaway of the driven objects have been confirmed.
2. When the product is to be removed, confirm that the safety measures as mentioned above are implemented and the power from any appropriate source is cut, and read and understand the specific product precautions of all relevant products carefully.
3. Before machinery/equipment is restarted, take measures to prevent unexpected operation and malfunction.

### **4. SMC products cannot be used beyond their specifications. They are not developed, designed, and manufactured to be used under the following conditions or environments. Use under such conditions or environments is not allowed.**

1. Conditions and environments outside of the given specifications, or use outdoors or in a place exposed to direct sunlight.
2. Use for nuclear power, railways, aviation, space equipment, ships, vehicles, military application, equipment affecting human life, body, and property, combustion equipment, entertainment equipment, emergency shut-off circuits, press clutches, brake circuits, safety equipment, etc., and use for applications that do not conform to standard specifications such as catalogs and operation manuals.
3. Use for interlock circuits, except for use with double interlock such as installing a mechanical protection function in case of failure. Please periodically inspect the product to confirm that the product is operating properly.



# Safety Instructions

## Caution

**SMC develops, designs, and manufactures products to be used for automatic control equipment, and provides them for peaceful use in manufacturing industries.**

**Use in non-manufacturing industries is not allowed.**

Products SMC manufactures and sells cannot be used for the purpose of transactions or certification specified in the Measurement Act of each country.

The new Measurement Act prohibits use of any unit other than SI units in Japan.

## Limited warranty and Disclaimer/Compliance Requirements

The product used is subject to the following “Limited warranty and Disclaimer” and “Compliance Requirements”.

Read and accept them before using the product.

### Limited warranty and Disclaimer

1. The warranty period of the product is 1 year in service or 1.5 years after the product is delivered, whichever is first.\*2)

Also, the product may have specified durability, running distance or replacement parts. Please consult your nearest sales branch.

2. For any failure or damage reported within the warranty period which is clearly our responsibility, a replacement product or necessary parts will be provided.

This limited warranty applies only to our product independently, and not to any other damage incurred due to the failure of the product.

3. Prior to using SMC products, please read and understand the warranty terms and disclaimers noted in the specified catalog for the particular products.

**\*2) Vacuum pads are excluded from this 1 year warranty.**

A vacuum pad is a consumable part, so it is warranted for a year after it is delivered.

Also, even within the warranty period, the wear of a product due to the use of the vacuum pad or failure due to the deterioration of rubber material are not covered by the limited warranty

### Compliance Requirements

1. The use of SMC products with production equipment for the manufacture of weapons of mass destruction (WMD) or any other weapon is strictly prohibited.

2. The exports of SMC products or technology from one country to another are governed by the relevant security laws and regulations of the countries involved in the transaction. Prior to the shipment of a SMC product to another country, assure that all local rules governing that export are known and followed.

## Operator

- ◆ This operation manual is intended for those who have knowledge of machinery using pneumatic equipment, and have sufficient knowledge of assembly, operation and maintenance of such equipment. Only those persons are allowed to perform assembly, operation and maintenance.
- ◆ Read and understand this operation manual carefully before assembling, operating or providing maintenance to the product.

### ■ Safety Instructions

#### **Warning**

- Do not disassemble, modify (including changing the printed circuit board) or repair.  
An injury or failure can result.
- Do not operate the product outside of the specifications.  
Do not use for flammable or harmful fluids.  
Fire, malfunction, or damage to the product can result.  
Verify the specifications before use.
- Do not operate in an atmosphere containing flammable or explosive gases.  
Fire or an explosion can result.  
This product is not designed to be explosion proof.
- Do not use the product in a place where static electricity is a problem.  
Otherwise it can cause failure or malfunction of the system.
- If using the product in an interlocking circuit:
  - Provide a double interlocking system, for example a mechanical system
  - Check the product regularly for proper operationOtherwise malfunction can result, causing an accident.
- The following instructions must be followed during maintenance:
  - Turn off the power supply
  - Stop the air supply, exhaust the residual pressure and verify that the air is released before performing maintenanceOtherwise an injury can result.

## Caution

■ Do not touch the terminals and connectors while the power is on.  
Otherwise electric shock, malfunction or damage to the product can result.

■ After maintenance is complete, perform appropriate functional inspections and leak tests.  
Stop operation if the equipment does not function properly or there is a leakage of fluid.  
When leakage occurs from parts other than the piping, the product might be faulty.  
Disconnect the power supply and stop the fluid supply.  
Do not apply fluid under leaking conditions.  
Safety cannot be assured in the case of unexpected malfunction.

## ■ NOTE

- Follow the instructions given below when designing, selecting and handling the product.
  - The instructions on design and selection (installation, wiring, environment, adjustment, operation, maintenance, etc.) described below must also be followed.
- \*Product specifications
- The direct current power supply to be used should be UL approved as follows.  
Circuit (of class 2) which is of maximum 30 Vrms (42.4 V peak) or less, with UL 1310 class 2 power supply unit or UL 1585 class 2 transformer.
  - The product is a UL approved product only if it has a  mark on the body.
  - Use the specified voltage.  
Otherwise failure or malfunction can result.
  - Use the specified flow sensor.  
Otherwise the product may be broken and it will not be able to perform proper measurement.
  - Do not exceed the specified maximum allowable load.  
Otherwise it can cause damage or shorten the lifetime of the product.
  - Design the product to prevent reverse current when the circuit is opened or the product is forced to operate for operational check.  
Reverse current can cause malfunction or damage to the product.
  - Input data to the product is not deleted, even if the power supply is cut off.  
(Writing time: 1,500,000 cycles)
  - Reserve a space for maintenance.  
Allow sufficient space for maintenance when designing the system.

## ●Product handling

### \*Installation

- Tighten to the specified tightening torque.

If the tightening torque is exceeded the mounting screws and brackets may be broken.

If the tightening torque is insufficient, the product can be displaced and loosen the mounting screws.

- Be sure to ground terminal FG when using a commercially available switch-mode power supply.
- Do not drop, hit or apply shock to the product.

Otherwise damage to the internal parts can result, causing malfunction.

- Do not pull the lead wire forcefully, not lift the product by pulling the lead wire.

(Tensile force 50 N or less)

Hold the body when handling to avoid the damage of the product which lead to cause the failure and malfunction.

### \*Wiring

- Do not pull the lead wires. In particular, do not lift or carry the product by holding the cables once they are connected to the product.

Otherwise damage to the internal parts can result, causing malfunction or to be off the connector.

- Avoid repeatedly bending or stretching the lead wire, or placing heavy load on them.

If the lead wire can move, fix it near the body of the product.

The recommended bend radius of the lead wire is 6 times the outside diameter of the sheath, or 33 times the outside diameter of the insulation material, whichever is larger.

Replace the damaged lead wire with a new one.

- Wire correctly.

Incorrect wiring can break the product.

- Do not perform wiring while the power is on.

Otherwise damage to the internal parts can result, causing malfunction.

- Do not route wires and cables together with power or high voltage cables.

Otherwise the product can malfunction due to interference of noise and surge voltage from power and high voltage cables to the signal line. Route the wires (piping) of the product separately from power or high voltage cables.

- Confirm proper insulation of wiring.

Poor insulation (interference from another circuit, poor insulation between terminals, etc.) can lead to excess voltage or current being applied to the product, causing damage.

- Design the system to prevent reverse current when the product is forced to operate for operational check.

Depending on the circuit used, insulation may not be maintained when operation is forced, allowing reverse current to flow, which can cause malfunction and damage the product.

- Keep wiring as short as possible to prevent interference from electromagnetic noise and surge voltage.

Do not use a cable longer than 30 m.

Wire the DC(-) line(blue) as close as possible to the power supply.

### \*Environment

- Do not use the product in area that is exposed to corrosive gases, chemicals, sea water, water or steam.

Otherwise failure or malfunction can result.

- Do not use the product in an environment where the product is constantly exposed to water or oil splashes.

If the product is to be used in an environment containing oils or chemicals such as coolant or cleaning solvent, it may be adversely affected (damage, malfunction, or hardening of the lead wires).

- Do not use in an area where surges are generated.

If there is equipment which generates a large amount of surge (solenoid type lifter, high frequency induction furnace, motor, etc.) close to the product, this may cause deterioration or breakage of the internal circuit of the product. Avoid sources of surge generation and crossed lines.

- Do not use a load which generates surge voltage.  
When a surge-generating load such as a relay or solenoid is driven directly, use a load with a built-in surge suppressor.
- The product is CE/UKCA marked, but not immune to lightning strikes. Take measures against lightning strikes in the system.
- Mount the product in a place that is not exposed to vibration or impact.  
Otherwise failure or malfunction can result.
- Prevent foreign matter such as remnant of wires from entering the product.  
Take proper measures for the remnant not to enter the product in order to prevent failure or malfunction.
- Do not use the product in an environment that is exposed to temperature cycle.  
Heat cycles other than ordinary changes in temperature can adversely affect the inside of the product.
- Do not expose the product to direct sunlight.  
If using in a location directly exposed to sunlight, shade the product from the sunlight.  
Otherwise failure or malfunction can result.
- Keep within the specified ambient temperature range.  
The ambient temperature range is 0 to 50 °C. Operation at low temperature (5 °C or less) may cause damage or operation failure due to frozen moisture in the air.  
Protection against freezing is necessary.  
Avoid sudden temperature change even within specified temperature.
- Do not operate close to a heat source, or in a location exposed to radiant heat.  
Otherwise malfunction can result.

#### \*Adjustment and Operation

- Turn the power on after connecting a load.  
Otherwise it can cause excess current causing instantaneous breakage of the product.
- Do not short-circuit the load.  
Although error is displayed when the load at the output part has a short circuit, generated over current may lead to the damage of the product.
- Do not press the setting buttons with a sharp pointed object.  
It may damage the setting buttons.
- If using the product to detect very small pressure rates, warm up the product for 10 to 15 minutes first.  
There will be a drift on the display or the analogue output of approximate  $\pm 1\%$  immediately after the power supply is turned on, within 10 minutes.
- Perform settings suitable for the operating conditions.  
Incorrect setting can cause operation failure.  
For details of each setting, refer to page 21 to 74 of this manual.
- Do not touch the LCD during operation.  
The display can vary due to static electricity.

#### \*Maintenance

- Turn OFF the power supply before maintenance.  
There is a risk of unexpected malfunction.
- Perform regular maintenance and inspections.  
There is a risk of unexpected malfunction.
- Do not use solvents such as benzene, thinner etc. to clean the product.  
They could damage the surface of the body and erase the markings on the body.  
Use a soft cloth to remove stains. For heavy stains, use a cloth soaked with diluted neutral detergent and fully squeezed, then wipe up the stains again with a dry cloth.



## Model Indication and How to Order

PFGM 3 **0** 2- **RT** - **M** - **L** **A1** **C** **Y**

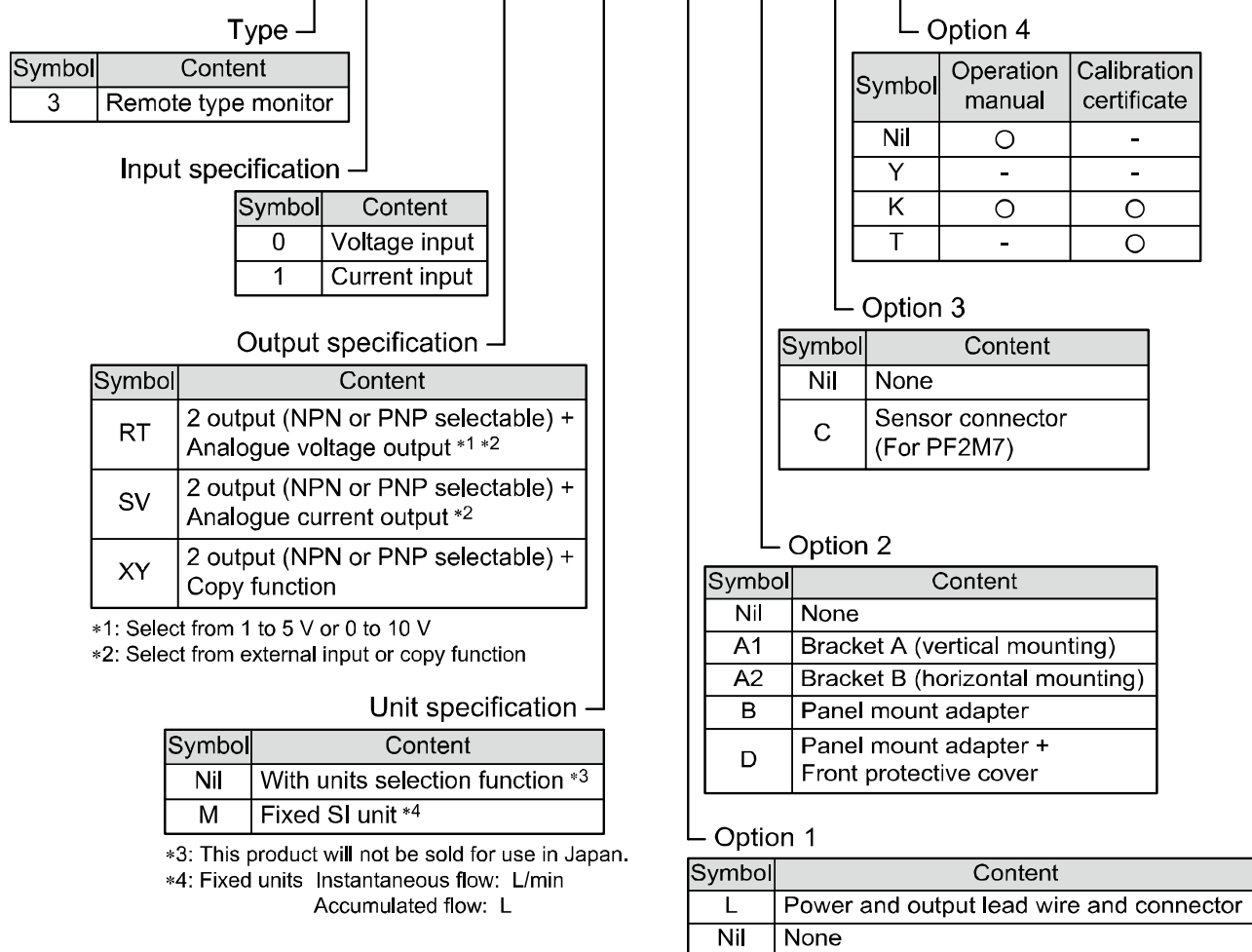

### ○Accessories/Part numbers

If an option is required independently, order with the following part numbers.

Items	Part No.	Remarks
Sensor connector (For PF2M7)	ZS-28-C-1	
Bracket A	ZS-46-A1	Self tapping screws: Nominal size 3 x 8L (2 pcs)
Bracket B	ZS-46-A2	Self tapping screws: Nominal size 3 x 8L (2 pcs)
Panel mount adapter	ZS-46-B	
Panel mount adapter + Front protective cover	ZS-46-D	
Lead wire with connector	ZS-46-5L	5 cores, 2 m
Front protective cover	ZS-27-01	

## Summary of Product parts

### Names of individual parts

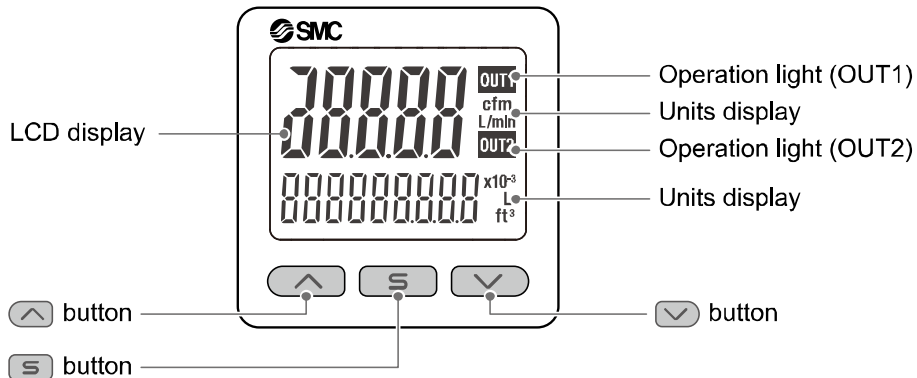

Operation light: Displays the switch operating condition.

LCD display: Displays the current status of flow, setting mode, selected display units and error code.

4 types of display can be selected for the main display: Single colour of constant red or green; or switching from red to green or green to red corresponding to the output.

The indication for the sub display is orange.

↑ button: Increases mode and ON/OFF set values.

↓ button: Decreases mode and ON/OFF set values.

S button: Press this button to change mode and to confirm settings.

Unit display: Indicates the units currently selected.

## ■ Definition and terminology

	Term	Definition
A	Accumulated flow	The total amount of fluid that has passed through the device. If an instantaneous flow of 100 L/min lasts for 5 minutes, the accumulated flow will be $5 \times 100 = 500$ L.
	Accumulated pulse output	A type of output where a pulse is generated every time a predefined accumulated flow passes. It is possible to calculate the total accumulated flow by counting the pulses.
	Accumulated-value hold time	A function to store the cumulative flow value in the product's internal memory at set time intervals. The memory data is read when power is supplied. Accumulation of data begins with the value read at the moment power is supplied. The time interval for storing to memory can be selected from 2 or 5 minutes.
	Analogue output	An Output value proportional to the flow rate. When the analogue output is in the range of 1 to 5 V, it will vary between 1 to 5 V according to the flow rate change. The same occurs for analogue output of 0 to 10 V and 4 to 20 mA.
B	Bottom value display (mode)	The min. flow recorded from when the power was supplied to the present time.
C	Chattering	The problem of the switch output turning ON and OFF repeatedly around the set value at high frequency due to the effect of pulsation.
	Copy function	Function to copy the set values of the copy source monitor to a copy destination monitor.
D	Delay time	The setting time from when the connected flow sensor signal reaches the set value, to when the ON-OFF output actually operates. Adjusting the delay time can prevent the output from chattering.
	Digit (smallest settable increment)	How precisely the pressure can be displayed or set. When 1 digit = 1 L/min, the value is displayed in increments of 1 L/min, e.g., 1, 2, 3, ..., 99, 100.
	Digital filter	Function to add digital filtering to any fluctuation in the input signal. Smooth the fluctuation of the displayed value for sharp start up or fall of the flow. When the function is used, digital filtering is reflected in the switch output ON/OFF or analogue output. Output chattering or display flicker in measurement mode can be reduced by setting the digital filter. The response time indicates when the set value is 90% in relation to the step input.
	Display accuracy	The max. deviation between the displayed flow rate and the actual flow rate.
	Display colour	Indicates the colour of the digital display. Always green, always red, green (switch OFF) changing to red (switch ON), or red (switch OFF) changing to green (switch ON) are available in window comparator mode.
	Display range	The range of flow that can be displayed.
	Display resolution	Indicates into how many units the rated flow range can be divided. (Example: When the value can be displayed down to 0.1 L/min for a product with a rated flow range of 100 L/min, the resolution is 1/1000).
E	Energy saving mode	Operating mode in which the digital display turns off to reduce power consumption.
	Error display	A code number displayed to identify the error code detected by the self-diagnostic function of the product. Refer to "Error indication function" on page 82 for details of the errors.
	Error output	Switches the switch output to ON/OFF when an error is displayed.
F	F.S. (full span/full scale)	Abbreviation of full span or full scale; the difference between the min. and max. rated flow values. In other words the max. rated fluctuation range of the flow switch. For example, when the rated flow range is 0 to 1000 L/min, F.S. = $1000 - (0) = 1000$ L/min. (Reference: $1\%F.S. = 1000 \times 0.01 = 10$ L/min)

	Term	Definition
F	Function selection mode	The mode in which setting of functions is performed. It is a separate menu from the display setting. If any function settings need to be changed from the factory default, each setting can be selected with "F*". The setting items are: display colour, display range, display units, operation mode, output type, delay time, digital filter, power saving mode, security code, etc.
H	Hysteresis	The difference between ON and OFF points used to prevent chattering. Hysteresis can be effective in avoiding the effects of pulsation.
	Hysteresis mode	Mode where the switch output will turn ON when the flow is greater than the set value, and will turn OFF when the flow falls below the set value by the amount of hysteresis or more.
I	Insulation resistance	The insulation resistance between the electrical circuit and the case.
K	Key-lock function	Function that prevents changes to the settings (disables button operation).
M	Max. applied voltage	The max. voltage that can be connected to the output of an NPN device.
	Max. load current	The max. current that can flow to the switch output.
	Measurement mode	Operating condition in which pressure is being detected and displayed, and the switch function is working.
	Min. resolution	Refer to "digit".
N	Normal output	One of the switch output types. In hysteresis mode the switch output is turned ON when flow equal to or greater than the switch output set value is detected. In window comparator mode, the switch output is turned ON when flow between the switch output set values (P1L to P1H) is detected.
O	Operation LED	An LED that turns on when the switch output is ON.
	Operation mode	Operation selected from Hysteresis mode/ Window comparator mode/ Accumulated output mode/Accumulated pulse mode/ Error detection mode/ Output OFF mode.
	Output	The operation principle of the switch output. Normal output and reverse output can be selected.
P	Peak value display (mode)	The max. flow rate recorded from when the power was supplied to the present time.
R	Rated flow range	The flow range within which the product will meet all published specifications.
	Repeatability	The repeatability of the display or analogue output value, when the measured flow quantity is repeatedly increased and decreased.
	Resolution	Refer to "Display resolution".
	Reversed output	One of the switch output types. In hysteresis mode the switch output is turned ON when a flow less than or equal to the switch output set value is detected. In window comparator mode, the switch output is turned ON when flow outside of the switch output set values (n1L to n1H) is detected.
	Ripple	A type of chattering.
S	Set point range	The flow range that can be set for the switch output.
	Switch output	Output type that only has 2 possible states, ON or OFF. Sometimes referred to as "ON-OFF output".
U	Units selection function	A function to select the display units other than the international units (SI units) specified in Japanese measurement law. The product for use in Japan is not equipped with this function.
W	Window comparator mode	An operating mode in which the switch output is turned on and off depending on whether the flow is inside or outside a range of two set values.
	Withstand voltage	A measure of the product's resistance to a voltage applied between the electrical circuit and case. The product may be damaged if a voltage above this value is applied. (The withstand voltage is not the supply voltage used to power the product).

# Mounting and Installation

## ■ Installation

### ○ Mounting with bracket

- Mount the bracket to the body with mounting screws (Self tapping screws: Nominal size 3 x 8L (2 pcs.)), then set the body to the specified position.

\*: Tighten the bracket mounting screws to a torque of  $0.5 \pm 0.05 \text{ N}\cdot\text{m}$ .  
Self tapping screws are used, and should not be re-used several times.

- Bracket A (Part No.: ZS-46-A1)

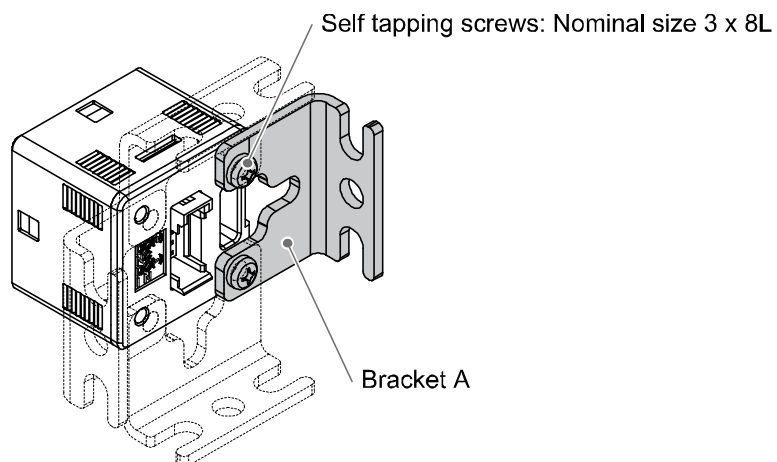

- Bracket B (Part No.: ZS-46-A2)

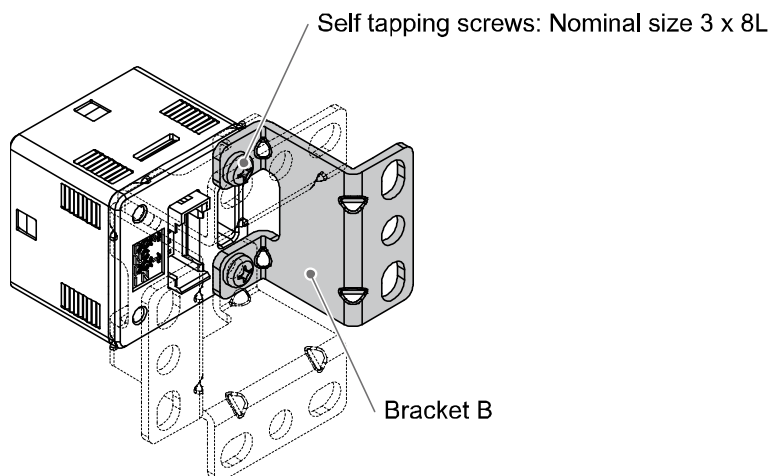

○ Mounting with panel mount adapter

● Mount part (a) to the front of the body and fix it. Then insert the body with (a) into the panel until (a) comes into contact with the panel front surface. Next, mount part (b) to the body from the rear and insert it until (b) comes into contact with the panel for fixing.

● Panel mount adapter (Part No.: ZS-46-B)

Panel mount adapter + Front protective cover (Part No.: ZS-46-D)

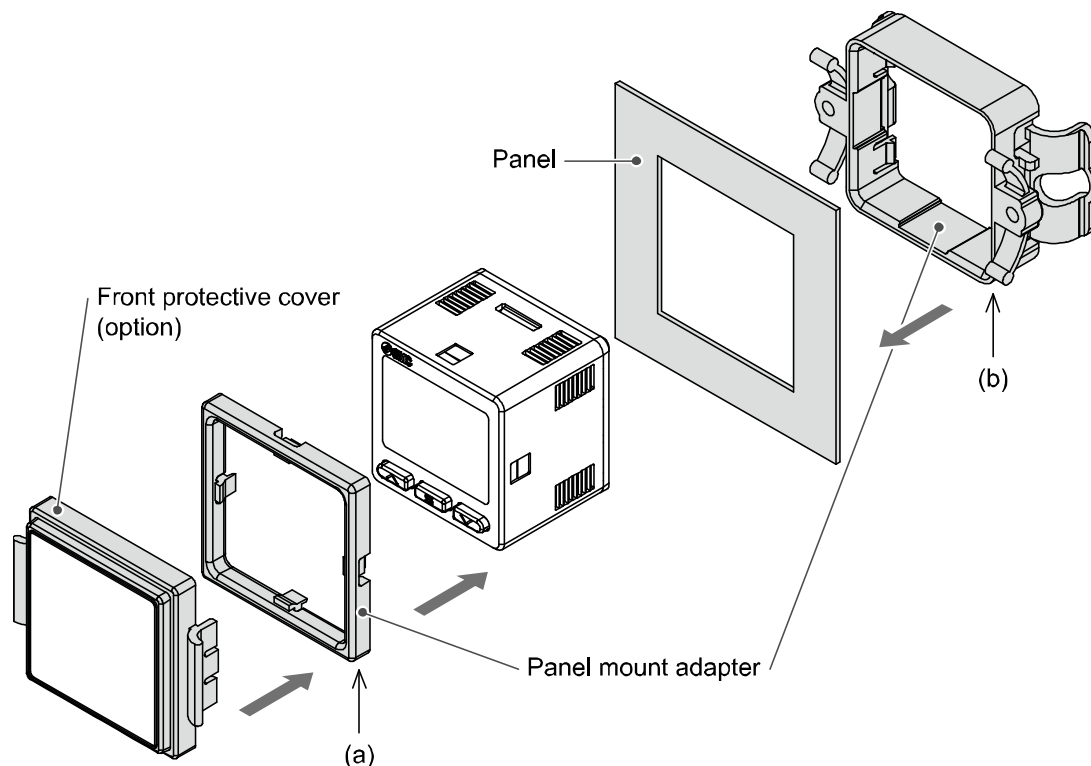

\*: The panel mount adapter can be rotated through 90 degrees for mounting.

**How to remove the panel mount adapter**

● When removing the digital flow switch with panel mount adapter from the installation, pull it forward while expanding the hooks on each side as shown below. If the panel mount adapter is pulled forward with the hook caught, the product and the adapter may be damaged.

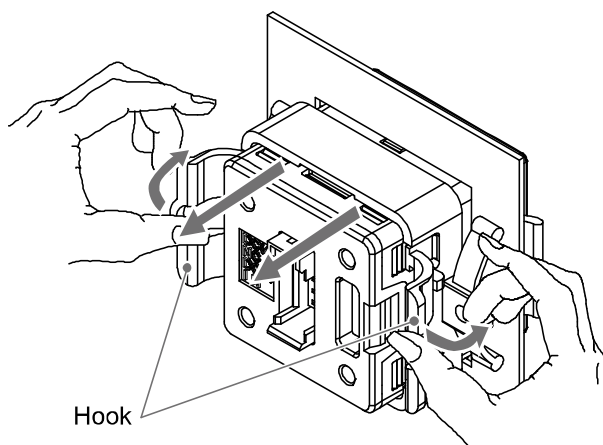

## ■Wiring

### ○Wiring connections

- Connections should be made with the power supply turned off.
- Use a separate route for the product wiring and any power or high voltage wiring. Otherwise, malfunction may result due to noise.
- If a commercially available switching power supply is used, be sure to ground the frame ground (FG) terminal. If the switching power supply is connected for use, switching noise will be superimposed and it will not be able to meet the product specifications. In that case, insert a noise filter such as a line noise filter/ferrite between the switching power supplies or change the switching power supply to the series power supply.

### ○How to use connector

#### Connector attachment/detachment

- When connecting the connector, insert it straight onto the pins, holding the lever and connector body, and lock the connector by pushing the lever hook into the concave groove on the housing.
- To detach the connector, remove the hook from the groove by pressing the lever downward, and pull the connector straight out.

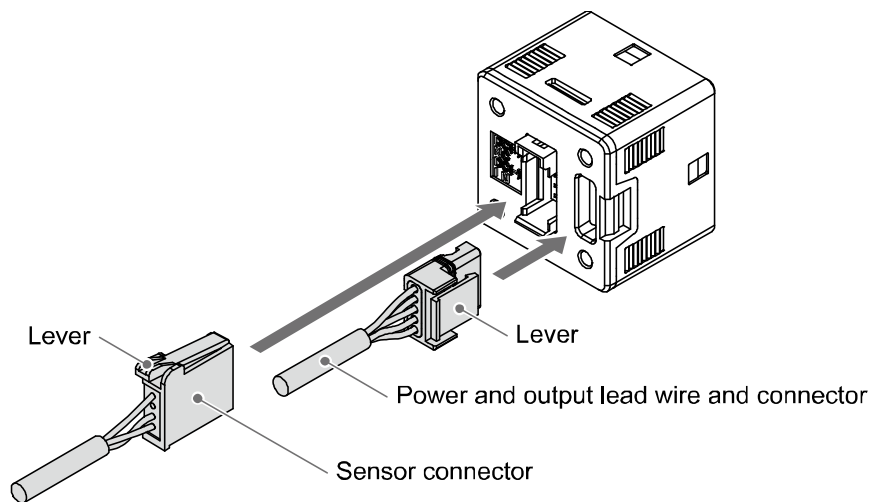

#### Connector pin out

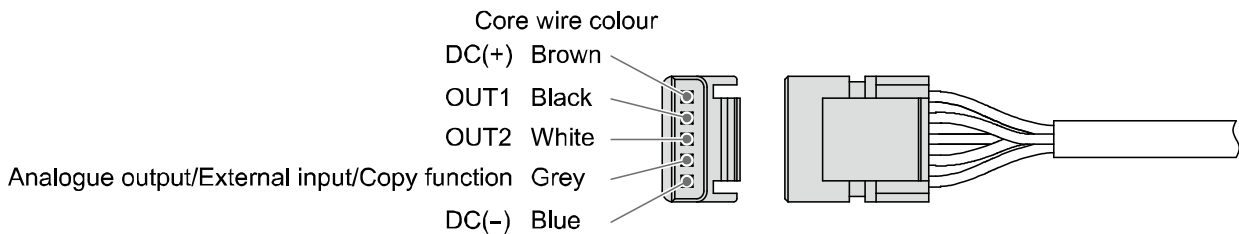

## Attaching the connector to the sensor wire

- Strip the sensor wire as shown.
- Do not cut the insulator.
- Insert the corresponding wire colour shown in the table into the pin number printed on the sensor connector, to the bottom.

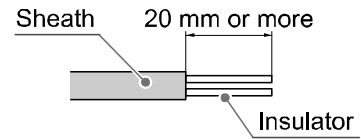

Pin no.	Wire colour *	Description
1	Brown	DC(+)
2	NC	-
3	Blue	DC(-)
4	White	IN

\*: The wire colours shown are for the PFMB, PF2MC, PF3A7, and PF2M7 series cables.

- Check that the above preparation has been performed correctly, then part A shown should be pressed in by hand to make temporary connection.

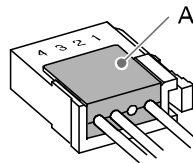

- Part A should then be pressed in using a suitable tool, such as pliers.

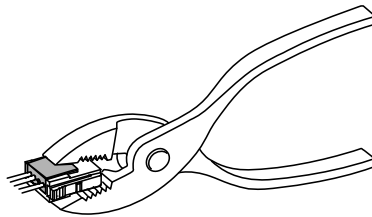

- The sensor connector cannot be re-used once it has been fully crimped. In cases of connection failure such as incorrect order of wires or incomplete insertion, please use a new connector.
- If the sensor is not connected correctly "LLL" or "HHH" will be displayed.



○ Internal circuit and wiring examples

**PFGM3#2-#-#-####**

- Output specification

**-RT/-SV**

- NPN open collector 2 output + Analogue output

Max. 30 V, 80 mA

Residual voltage: 1 V or less

RT: Analogue output 1 to 5 V, 0 to 10 V

Output impedance 1 k $\Omega$

SV: Analogue output 4 to 20 mA

Max. load impedance

Power supply voltage 12 V: 300  $\Omega$

Power supply voltage 24 V: 600  $\Omega$

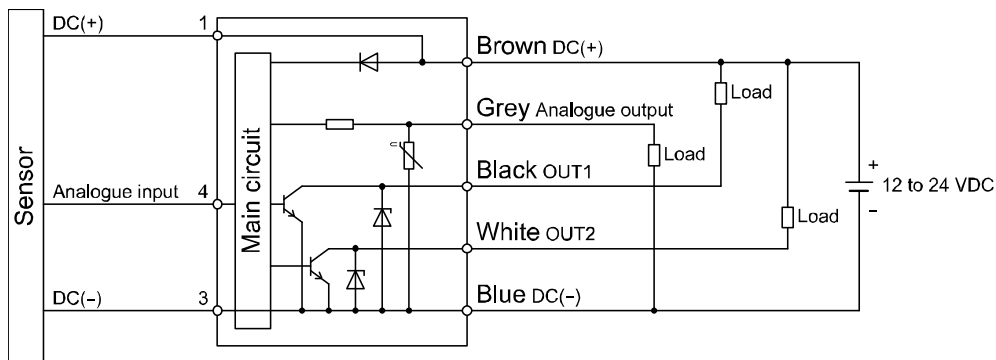

**-RT/-SV**

- NPN open collector 2 output + External input

Max. 30 V, 80 mA

Residual voltage: 1 V or less

External input: Input voltage 0.4 V or less (reed or solid state), 30 msec or more

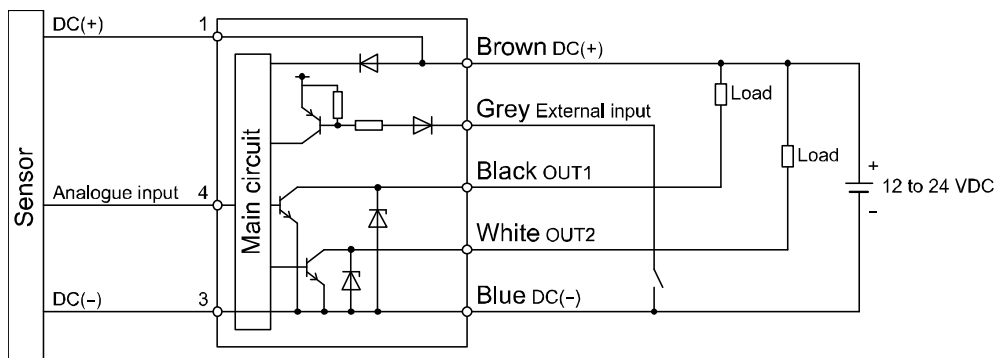

**-RT/SV/XY**

- NPN open collector 2 output + Copy function
- Max. 30 V, 80 mA
- Residual voltage: 1 V or less

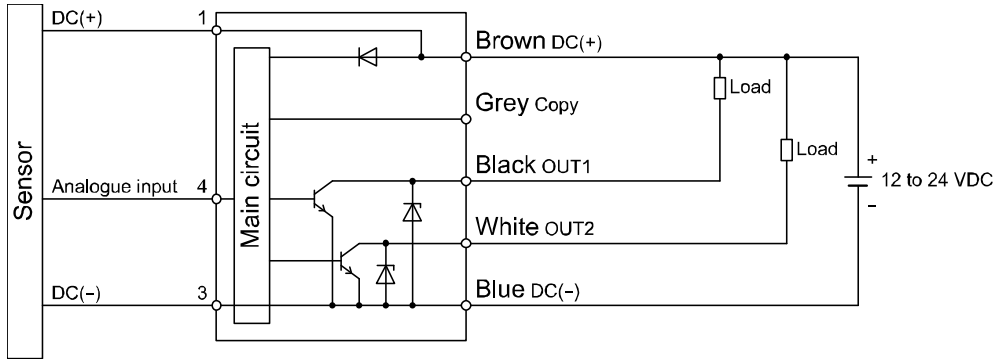

**-RT/-SV**

- PNP open collector 2 output + Analogue output
- Max. 80 mA
- Residual voltage: 1.5 V or less
- RT: Analogue output 1 to 5 V, 0 to 10 V
- Output impedance 1 k $\Omega$
- SV: Analogue output 4 to 20 mA
- Max. load impedance
- Power supply voltage 12 V: 300  $\Omega$
- Power supply voltage 24 V: 600  $\Omega$

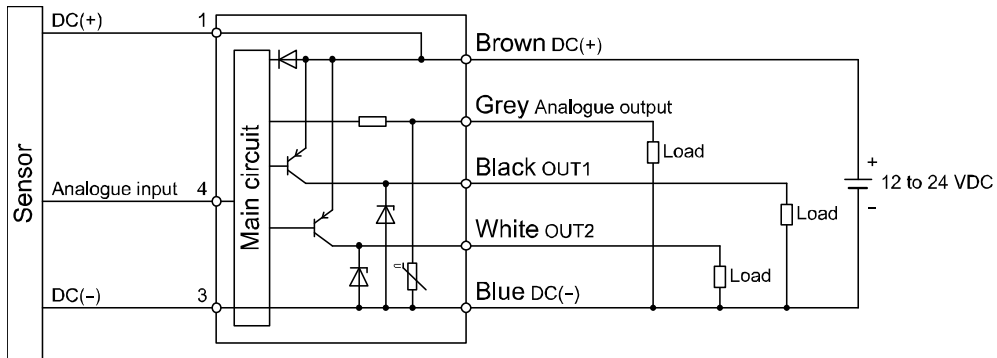

**-RT/-SV**

- PNP open collector 2 output + External input

Max. 80 mA

Residual voltage: 1.5 V or less

External input: Input voltage 0.4 V or less (reed or solid state), 30 msec or more

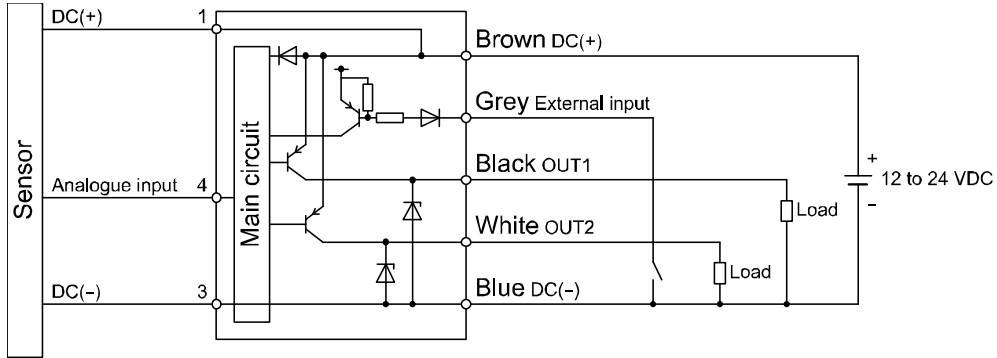

**-RT/SV/XY**

- PNP open collector 2 output + Copy function

Max.30 V, 80 mA

Residual voltage: 1.5 V or less

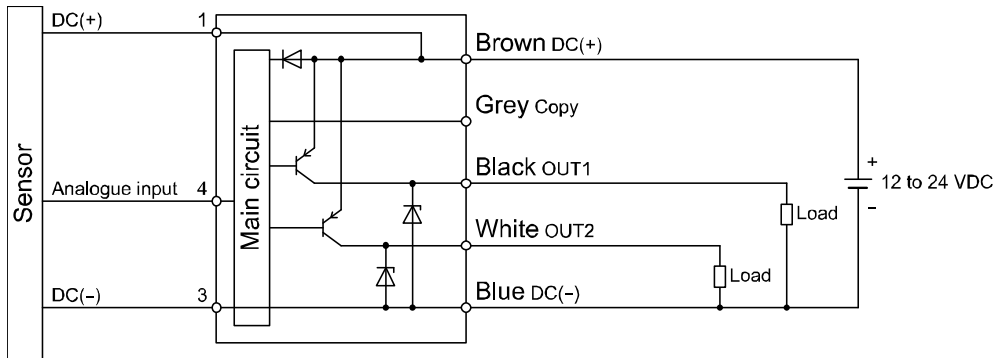

## Example for wiring for accumulated pulse output

NPN open collector 2 output

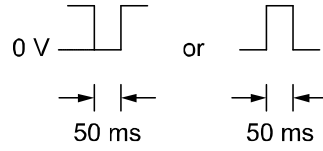
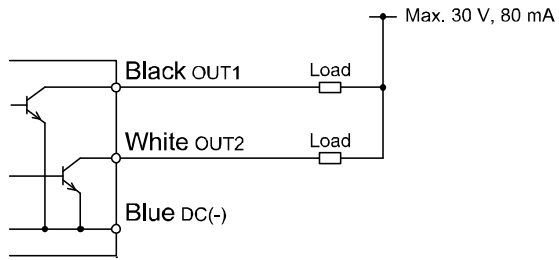

PNP open collector 2 output

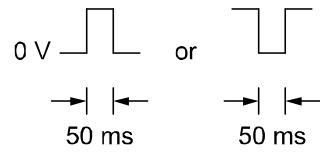
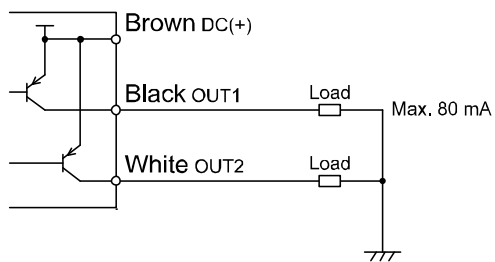

## Flow Setting

### Default settings

When the flow exceeds the set value, the switch will be turned on.

When the flow falls below the set value by the amount of hysteresis or more, the switch will be turned off.

The default setting is that the output will be turned ON at 5 L/min when the flow range of the connected sensor is 10 L/min.

Perform initial settings while referring to the "Outline of Settings" section (page 22).

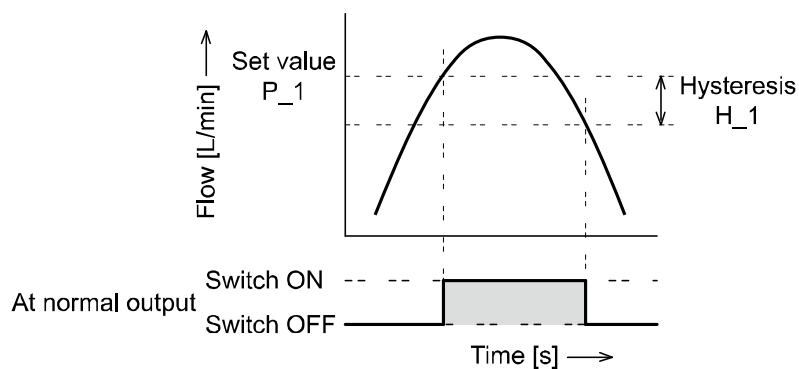

# Outline of Settings

**Power is supplied.**



The product code is displayed for approximately 3 sec. after power is supplied. Then, measurement mode will be displayed.

\*: When moving on to measurement mode, the switch operation will start.



## [Initial setting] (Refer to page 23.)

Set the flow range, display unit and NPN/PNP output specifications of the connected sensor.



## [Measurement mode]

Detects the flow after power is supplied, and indicates the display and switch operating status. This is the basic mode; other modes should be selected for set-point changes and other function settings.

### Measurement mode screen

Current flow value (Main display)

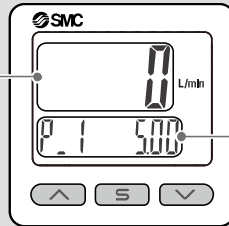

Item (Sub display (left))  
Accumulated value, set value or peak/bottom value (Sub display (right))

### Sub display (Hysteresis mode)

In measurement mode, the display of the sub display can be temporarily changed by pressing the or buttons.

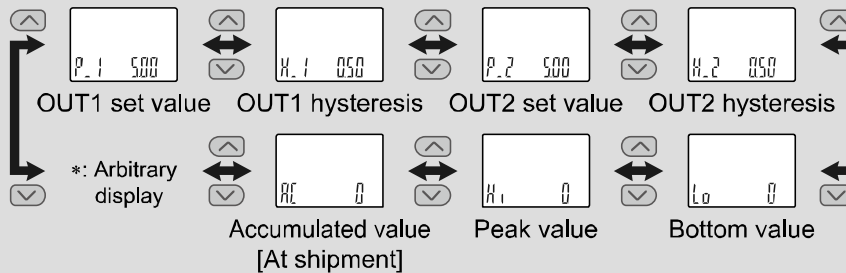

\*: One arbitrary display mode can be added to the sub display by setting the [F10] sub display setting. (The default setting does not include arbitrary display.)

Press the button once.

Press the button between 1 and 3 sec.

Press the button between 3 and 5 sec.



### [3 Step Setting Mode]

Set either of set value or hysteresis. (Refer to page 29.)

### [Simple Setting Mode]

Select the set value and hysteresis. (Refer to page 31.)

### [Function Selection Mode]

Change the function settings. (Refer to page 32.)

### [Other Settings]

- Reset operation
- Key-lock function (Refer to page 71.)

\*: The outputs will continue to operate during setting.

\*: 3 step setting mode, simple setting mode and function selection mode settings are reflected each other.

# Initial Setting

Set the flow range, display unit and NPN/PNP output specifications of the connected sensor.

Measurement mode

Press the **S** button between 3 and 5 sec.

[F 0] Display the switching function of the flow range, display unit and switch output specifications.



Press the **S** button Move on to flow range setting.

## Flow range setting

Press the **▲** or **▼** button to select the flow range.

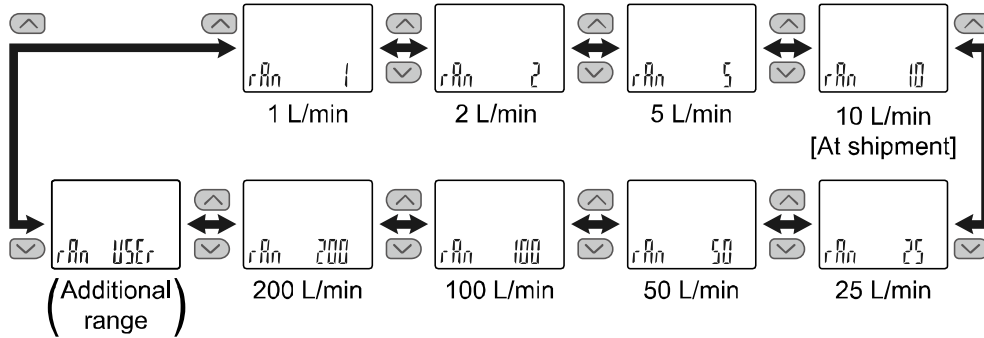

When [USEr] is selected  
Press the **S** button to move on to additional range minimum unit setting.

When other than [USEr] is selected  
Press the **S** button to move on to setting of fluid.

### Additional range minimum unit setting

Press the or button to select the minimum unit.

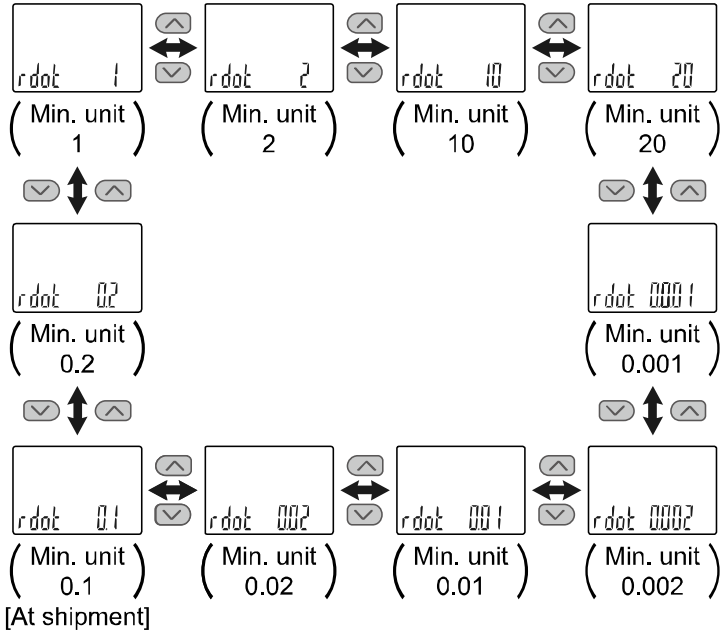

Press the button to set.

Move on to setting of the lower limit of the additional rated range. The lower limit of the rated range is the displayed value when the sensor input signal is 0%.

### Setting of the lower limit of the additional rated range

Press the or button to change the value. Press the button continuously to keep changing the value.

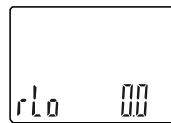

Set the value that is required to be displayed when the sensor input signal is 0%. The setting range is -1500 to 1500 digit.

Press the button to set.

Move on to setting of the upper limit of the additional rated range. The upper limit of the rated range is the displayed value when the sensor input signal is 100%.



↓

### Setting of the upper limit of the additional rated range

Press the or button to change the value.  
Press the button continuously to keep changing the value.



Set the value that is required to be displayed when the sensor input signal is 100%. The setting range is -1500 to 1500 digit.

Press the button to set. ↓ Move on to setting of the accumulated additional rated range and additional range minimum unit.

### Setting of the accumulated additional rated range and additional range minimum unit

Press the or button to select the accumulated range display or minimum unit for setting.

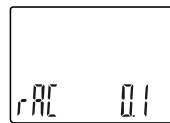

\*: Settable minimum unit and converted value is different depending on the minimum unit for the additional range.

Press the button to set. ↓ Move on to setting of the conversion of accumulated pulse of the additional

### Setting of the conversion of accumulated pulse of the additional range.

Press the or button to select the conversion of accumulated pulse of the additional range.

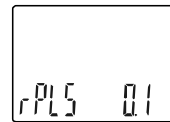

\*: Settable minimum unit and converted value is different depending on the minimum unit for the additional range.

Press the button to set. ↓ Move on to display unit setting.

↓

### Fluid setting

Press the or button to change the fluid.

FLU Air

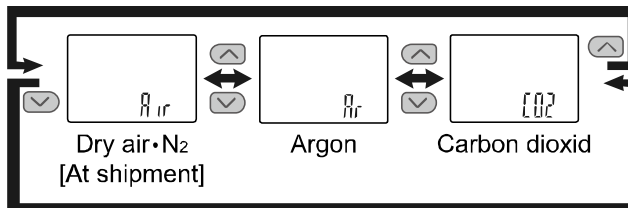

\*: The fluid setting should be the same as that of the PF2M7, the connecting sensor.

When unit selection function is available.  
Press the button to move on to display unit setting.

When fixed SI unit is available.  
Press the button to Move on to switching setting of switch output NPN/PNP specifications.

### Display unit setting

Press the or button to change the display units.

Unit L

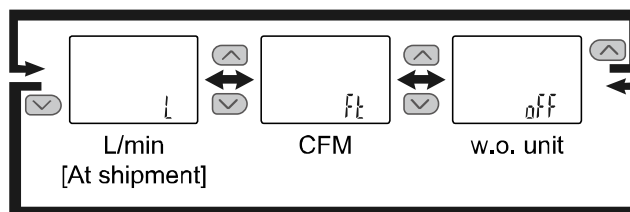

\*: [CFM] cannot be selected if the additional range is set by the SI unit.

\*: [w/o unit] cannot be selected if set items other than additional range are set with the units selection function.



Press the button to set.

Move on to switching setting of switch output NPN/PNP specifications.



### Switching setting of switch output NPN/PNP specifications

The switch output of this product can be switched to NPN or PNP output in accordance with the user device construction.

The switch output specification can be selected by pressing  or  button.

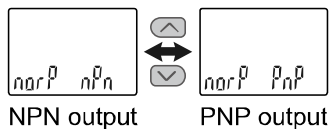

Press the  button to set.  Return to function selection mode.

[F 0] Setting of the switching function of the flow range, display unit and switch output specifications is completed.

 Press the  button 2 seconds or longer.

Measurement mode  
(Initial setting completed)

Perform the setting with the 3 step setting mode, simple setting mode and function selection mode.

Flow specification when [Ft] is selected by the units selection function

Model		PFGM3#2								
Applicable SMC Flow Switch	Model	PF2M701	PF2M702	PF2M705	PF2M710	PF2M725	PF2M750	PF2M711	PF2M721	
	Rated flow range	0.4 to 35.3 cfm×10 <sup>-3</sup>	0.7 to 70.6 cfm×10 <sup>-3</sup>	0.002 to 0.177 cfm	0.004 to 0.353 cfm	0.009 to 0.883 cfm	0.02 to 1.77 cfm	0.04 to 3.53 cfm	0.07 to 7.06 cfm	
Flow	Set flow rate range	Instantaneous flow	-1.8 to 37.1 cfm×10 <sup>-3</sup>	-3.5 to 74.2 cfm×10 <sup>-3</sup>	-0.009 to 0.185 cfm	-0.018 to 0.371 cfm	-0.044 to 0.927 cfm	-0.09 to 1.85 cfm	-0.18 to 3.71 cfm	-0.35 to 7.42 cfm
		Accumulated flow	0 to 999,999.999 ft <sup>3</sup>			0 to 9,999,999.99 ft <sup>3</sup>			0 to 99,999,999.9 ft <sup>3</sup>	
	Min. setting unit	Instantaneous flow	0.01 cfm×10 <sup>-3</sup>		0.001 cfm			0.01 cfm		
		Accumulated flow	0.001 ft <sup>3</sup>			0.01 ft <sup>3</sup>			0.1 ft <sup>3</sup>	
	Accumulated volume per pulse	0.001 ft <sup>3</sup> /pulse				0.01 ft <sup>3</sup> /pulse			0.1 ft <sup>3</sup> /pulse	
Display	Displayable range	Instantaneous flow	-1.8 to 37.1 cfm×10 <sup>-3</sup>	-3.5 to 74.2 cfm×10 <sup>-3</sup>	-0.009 to 0.185 cfm	-0.018 to 0.371 cfm	-0.044 to 0.927 cfm	-0.09 to 1.85 cfm	-0.18 to 3.71 cfm	-0.35 to 7.42 cfm
		Accumulated flow	0 to 999,999.999 ft <sup>3</sup>			0 to 9,999,999.99 ft <sup>3</sup>			0 to 99,999,999.9 ft <sup>3</sup>	
	Min. display unit	Instantaneous flow	0.01 cfm×10 <sup>-3</sup>		0.001 cfm			0.01 cfm		
		Accumulated flow	0.001 ft <sup>3</sup>			0.01 ft <sup>3</sup>			0.1 ft <sup>3</sup>	

## 3 Step Setting Mode

### 3 step setting mode



In this mode, the set values can be input in just 3 steps.

Use this mode if the product is to be used straight away, after changing only the set values.

(The current flow value is displayed on the main display.)





#### <Operation>

[3 step setting mode (hysteresis mode)]

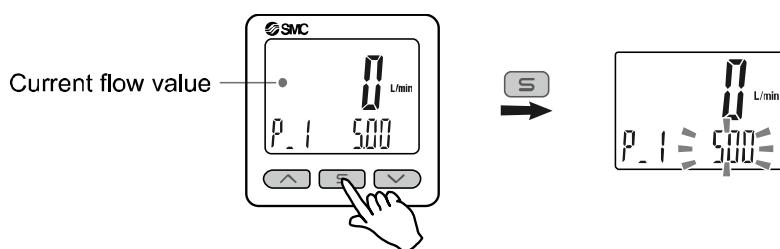
In the 3 step setting mode, the set value (P\_1 or n\_1, P\_2 or n\_2) and hysteresis (H\_1, H\_2) can be changed. Set the items on the sub display (set value or hysteresis) with  or  button. When changing the set value, follow the operation below. The hysteresis setting can be changed in the same way.

- (1) Press the  button once when the item to be changed is displayed on the sub display. The set value on the sub display (right) will start flashing.





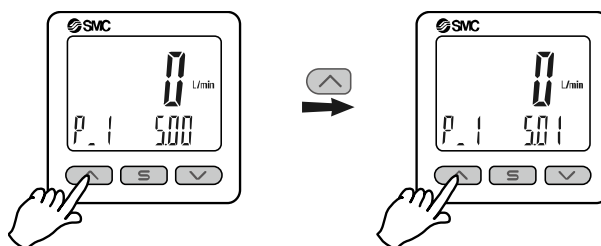

- (2) Press the  or  button to change the set value. The set value can be increased with  button and can be reduced with  button.

- Press the  button once to increase the value by one digit, press and hold to continuously increase.

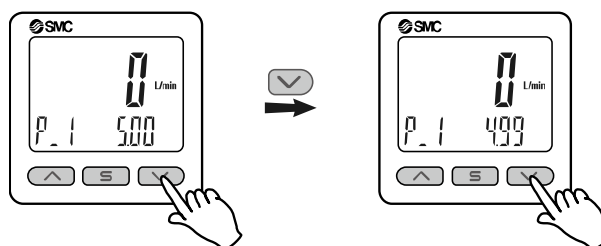

- Press the  button once to reduce the value by one digit, press and hold to continuously reduce.



- When the  and  buttons are pressed and held simultaneously for 1 second or longer, the set value is displayed as [- -], and the set value will be the same as the current flow value automatically (snap shot function (Refer to page 71.)). Afterwards, it is possible to adjust the value by pressing the  or  button.

- (3) Press the  button to complete the setting.

The Flow switch turns on within a set flow range (OUT1: from P1L to P1H, OUT2: from P2L to P2H) during window comparator mode. Set P1L/P2L, the lower limit of the switch operation, and P1H/P2H, the upper limit of the switch operation and WH1/WH2 (hysteresis) following the instructions given on page 29. (When reversed output is selected, the sub display (left) shows [n1L/n2L] and [n1H/n2H].)

In accumulated output mode, the switch will start at the set accumulated flow rate.  
Set each P1/P2 (set value), referring to the Setting method on page 29.  
(When reversed output is selected, the sub display (left) shows [n1/n2].)

Please refer to the "List of switch output modes" on page 43 for the relationship between the set values and operation.

- \*: Set OUT2 in the same way.
- \*: Setting of the normal/reverse output switching and hysteresis/window comparator mode switching are performed with the function selection mode [F 1] Setting of OUT1 and [F 2] Setting of OUT2.

## Simple Setting Mode

### <Operation>

[Simple setting mode (hysteresis mode)]

In the simple setting mode, the set value and hysteresis can be changed while checking the current flow value (main display).

- (1) Press and hold the **S** button between 1 and 3 seconds in measurement mode. [SEt] is displayed on the main display. When the button is released while in the [SEt] display, the current flow value is displayed on the main display, [P\_1] or [n\_1] is displayed on the sub display (left), and the set value is displayed on the sub display (right) (Flashing).

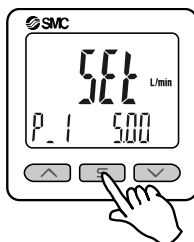

- (2) Change the set value with **▲** or **▼** button, and press the **S** button to set the value. Then, the setting moves to hysteresis setting. (The snap shot function can be used. (Refer to page 71.))

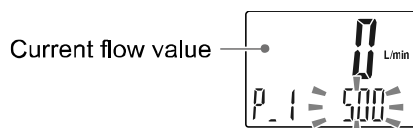

- (3) Change the set value with **▲** or **▼** button, and press the **S** button to set the value. Then, the setting moves to setting of OUT2. (The snap shot function can be used. (Refer to page 71.))

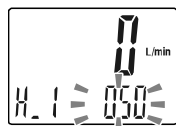

- (4) Press the **S** button for less than 2 seconds to complete the OUT1 setting. [P\_2] or [n\_2] is displayed on the sub screen (left). Continue with setting the OUT2. Press and hold the **S** button for 2 seconds or longer to complete the setting. The product will return to measurement mode.

\*1: Selected items (1) to (4) become valid after pressing the **S** button.

\*2: After enabling the setting by pressing the **S** button, it is possible to return to measurement mode by pressing the **S** button for 2 seconds or longer.

\*3: When the output mode (refer to page 39) is set to error output or switch output OFF, the simple setting mode cannot be used.

In the window comparator mode, set P1L/P2L, the lower limit of the switch operation, and P1H/P2H, the upper limit of the switch operation and WH1/WH2 (hysteresis) following the instructions given on page 31. (When reversed output is selected, the sub display (left) shows [n1L/n2L] and [n1H/n2H].)

Set each P1/P2 (set value), referring to the Accumulated output mode on page 31.

(When reversed output is selected, the main screen displays n1/n2).

Refer to the "List of output modes" on page 43 for the relationship between the set values and operation.

## Function Selection Mode

### ■Function selection mode

In measurement mode, press the **[S]** button between 3 and 5 seconds, to display [F 0]. Select to display the function to be changed [F□□]. Press and hold the **[S]** button for 2 seconds or longer in function selection mode to return to measurement mode.

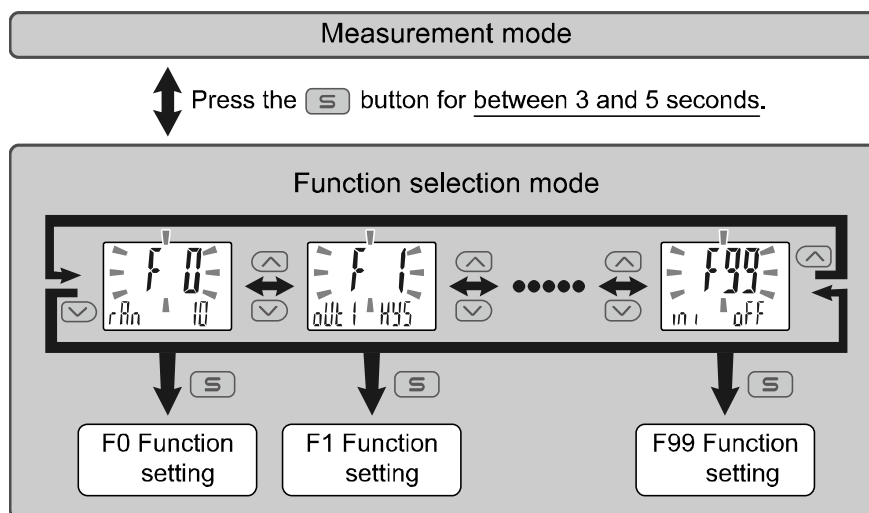

\*: Some products do not have all the functions. If no function is available or selected due to configuration of other functions, [- -] is displayed on the sub display (right).

### ■Default setting

The default setting is as follows.

If no problem is caused by this setting, keep these settings.

To change a setting, enter function selection mode.

- Switching function of [F 0] Flow range, display unit and switch output specifications ➡ Page 34

Item	Default setting
Flow range	10 L/min
Applicable fluid	Air
Display units *1	L
Switch output specifications	NPN

\*1: This setting is only available for models with the units selection function.

- [F 1] Setting of OUT1 ➡ Page 39

Item	Explanation	Default setting
Output mode	Either hysteresis mode, window comparator mode, accumulated output, accumulated pulse, error output or switch output off can be selected.	Hysteresis mode
Reversed output	Selects which type of switch output is used, normal or reversed.	Normal output
Flow setting	Sets the ON and OFF point of the switch output.	5.00 L/min
Hysteresis	Appropriate setting of the hysteresis will prevent the switch output from chattering.	0.50 L/min
Delay time	Delay time of the switch output can be selected.	0.00 s
Display colour	Select the display colour.	Output ON: Green Output OFF: Red (Linked to OUT1)



●[F 2] Setting of OUT2 ➡ Page 44

Item	Explanation	Default setting
Output mode	Either hysteresis mode, window comparator mode, accumulated output, accumulated pulse, error output or switch output off can be selected.	Hysteresis mode
Reversed output	Selects which type of switch output is used, normal or reversed.	Normal output
Flow setting	Sets the ON and OFF point of the switch output.	5.00 L/min
Hysteresis	Appropriate setting of the hysteresis will prevent the switch output from chattering.	0.50 L/min
Delay time	Delay time of the switch output can be selected.	0.00 s
Display colour	Select the display colour.	Output ON: Green Output OFF: Red (Linked to OUT1)

●Other parameter settings

Item	Page	Default setting
[F 3] Digital filter setting	Page 47	0.00 s
[F 4] Auto-preset function setting	Page 48	OFF
[F 5] FUNC terminal function setting *2	Page 50	Analogue output: 1 to 5 V/4 to 20 mA External input: Accumulated value reset
[F10] Sub display setting	Page 53	dEF
[F11] Display resolution setting *3	Page 55	1000-split
[F14] Display with zero cut-off setting	Page 56	1.0%F.S.
[F30] Accumulated value hold setting	Page 58	OFF
[F80] Power saving mode	Page 59	OFF
[F81] Security code	Page 60	OFF
[F90] Setting of all functions	Page 62	OFF
[F96] Sensor input/External input signal status display	Page 64	No configurable items
[F97] Copy setting	Page 65	No configurable items
[F98] Output check	Page 68	Normal output
[F99] Reset to default settings	Page 70	OFF

\*2: This function is available for models with analogue output.

\*3: This function is available at configurable products.

■[F 0] Flow range, fluid, display units and switch output specification

**Flow range setting**

A Flow range which is suitable for the connected sensor can be selected. In addition, the required range can be set and displayed. (Custom range)

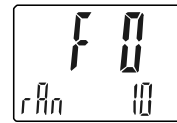

- Relationship between analogue input and digital display

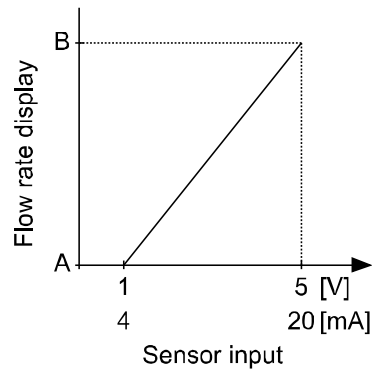

Set value	A	B
1	0 L/min	1 L/min
2	0 L/min	2 L/min
5	0 L/min	5 L/min
10(Default)	0 L/min	10 L/min
25	0 L/min	25 L/min
50	0 L/min	50 L/min
100	0 L/min	100 L/min
200	0 L/min	200 L/min
USEr	Input value (setting)	Input value (setting)

**<Operation>**

Press the or button in function selection mode to display [F 0].

Press the button. Move on to flow range setting.

**Flow range setting**

Press the or button to select the flow range.

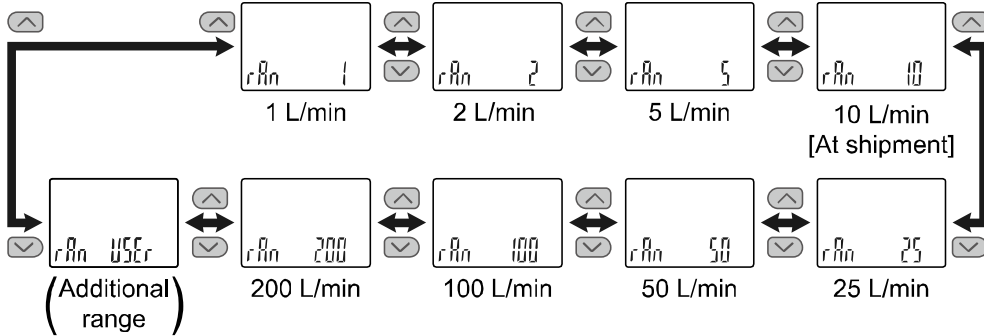

When [USER] is selected  
Press the button to move on to additional range minimum unit setting.

**Additional range minimum unit setting**

Press the or button to select the minimum unit.

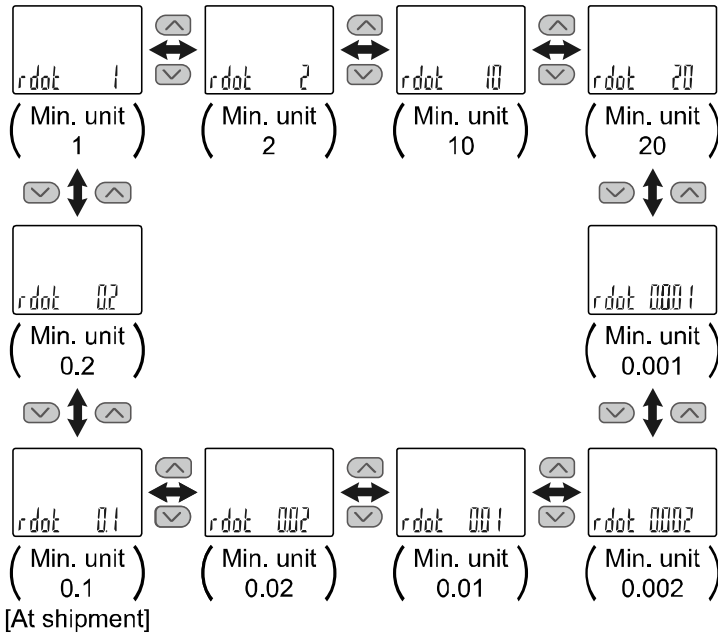



When other than [USER] is selected  
Press the button to move on to setting of fluid.

Press the button to set.

Move on to setting of the lower limit of the additional rated range.  
The lower limit of the rated range is the displayed value when the sensor input signal is 0%.

↓

### Setting of the lower limit of the additional rated range

Press the  or  button to change the value.  
Press the button continuously to keep changing the value.





Set the value that is required to be displayed when the sensor input signal is 0%. The setting range is -1500 to 1500 digit.

Press the  button to set.

↓ Move on to setting of the upper limit of the additional rated range. The upper limit of the rated range is the displayed value when the sensor input signal is 100%.

### Setting of the upper limit of the additional rated range

Press the  or  button to change the value.  
Press the button continuously to keep changing the value.





Set the value that is required to be displayed when the sensor input signal is 100%. The setting range is -1500 to 1500 digit.

Press the  button to set.

↓ Move on to setting of the accumulated additional rated range and additional range minimum unit.

### Setting of the accumulated additional rated range and additional range minimum unit

Press the  or  button to select the accumulated range display or minimum unit for setting.

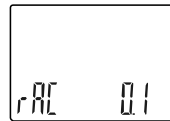

\*: Settable minimum unit and converted value is different depending on the minimum unit for the additional range.

Press the  button to set.

↓ Move on to setting of the conversion of accumulated pulse of the additional range.

↓

**Setting of the conversion of accumulated pulse of the additional range.**

Press the or button to select the conversion of accumulated pulse of the additional range.

rPLS 0.1



\*: Settable minimum unit and converted value is different depending on the minimum unit for the additional range.

Press the button to set.

Move on to display unit setting.

**button to set. Fluid setting**

Press the or button to change the fluid.

FLU Air

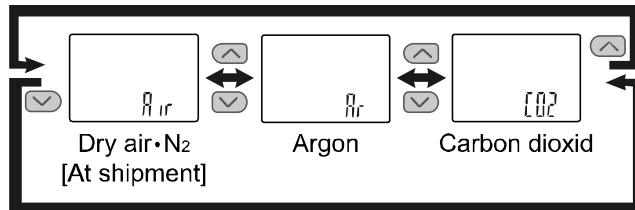

\*: The fluid setting should be the same as that of the PF2M7, the connecting sensor.

When unit selection function is available. Press the button to move on to display unit setting.

When fixed SI unit is available. Press the button to Move on to switching setting of switch output NPN/PNP specifications.

### Display unit setting

Press the  or  button to change the display units.

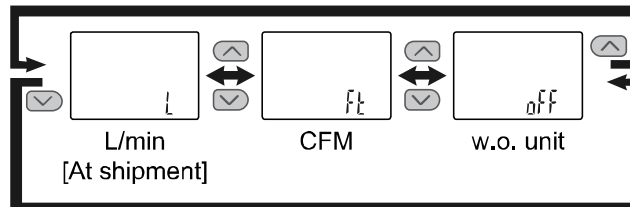
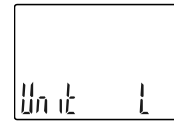

\*: [CFM] cannot be selected if the additional range is set by the SI unit.



\*: [w/o unit] cannot be selected if set items other than additional range are set with the units selection function.

Press the  button to set.

Move on to switching setting of switch output NPN/PNP specifications.

### Switching setting of switch output NPN/PNP specifications

The switch output of this product can be switched to NPN or PNP output in accordance with the user device construction.

The switch output specification can be selected by pressing  or  button.

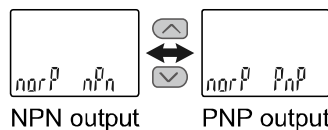

Press the  button to set.

Return to function selection mode.

[F 0] Setting of the switching function of the flow range, display unit and switch output specifications is completed.

\*: Refer to the flow specification when [ Ft ] is selected \* by the units selection function. (page 28)

## ■[F 1] Setting of OUT1

Set the output mode of OUT1.

The output signal turns ON when the flow is greater than the set value. When the output is ON the LED is green and when the output is OFF the LED is red as the default setting.

Refer to the "List of output modes" on page 43 for the relationship between the set items and the operation.

### <Operation>

Press the or button in function selection mode to display [F 1].

Press the button. Move on to output mode setting.

**Output mode setting**

Press the or button to select the required output mode.

Press the button to set. Move on to reversed output setting.

**Reversed output setting**

Press the or button to select the reversed output.

Press the button to set. Move on to flow setting.

**Flow setting**

Set the flow based on the setting method on page 29.

Hysteresis mode: [P\_1]  
 Window comparator mode: [P1L] [P1H]  
 "P" is changed to "n" as [1\_P] → [1\_n] when reversed output is selected.  
 The snap shot function can also be used.  
 (Refer to page 71.)

[AC] When accumulated output is selected

Press the button to move on to accumulated output setting.  
 (Refer to page 42.)

[OFF] Switch output OFF is selected.

Press the button to move on to display colour setting.

[Err] Error output, [PLS] When pulse output is selected

Press the button to move on to display colour setting.

Press the button to set. Move on to hysteresis setting.

### Hysteresis setting

Set the flow referring to the setting method on page 29.



Hysteresis mode: [H\_1]  
Window comparator mode: [WH1]  
The snap shot function can also be used.  
(Refer to page 71.)

Press the **S** button to set. ↓ Move on to delay time setting.

### Delay time setting

The delay time of the switch output can be set by pressing the **▲** or **▼** button. Setting the Delay time can prevent the output from chattering.

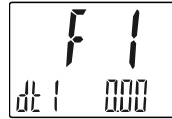

Delay time settable range :0.00 to 60.00 [S]

Press the **S** button to set. ↓ Move on to display colour setting.

### Display colour setting

Press the **▲** or **▼** button to select the display colour.



<b>Col 15aG</b>	<b>Col 15aR</b>	<b>Col 25aG</b>	<b>Col 25aR</b>	<b>Col rEd</b>	<b>Col Grn</b>
ON: Green OFF: Red (Linked to OUT1)	ON: Red OFF: Green (Linked to OUT1)	ON: Green OFF: Red (Linked to OUT2)	ON: Red OFF: Green (Linked to OUT2)	Normally: Red	Normally: Green

Press the **S** button to set. ↓ Return to function selection mode.

[F 1] Setting of OUT1 completed

\*1: The selected item becomes valid after pressing the **S** button.

\*2: After enabling the setting by pressing the **S** button, it is possible to return to the measurement mode by pressing the **S** button for 2 seconds or longer.



([AC] When accumulated output is selected)

### Accumulated output setting

Press the or button to select accumulated output.

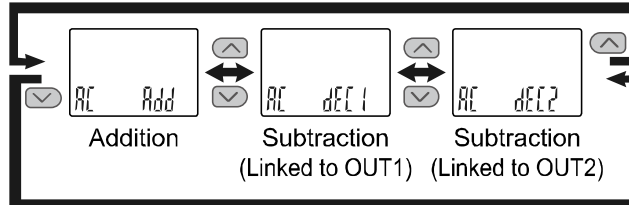

Press the button to set. Move on to accumulated value setting.

### Accumulated value setting

Perform the accumulated value setting (Refer to page 42.)

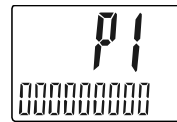

Press the button to set. Move on to display colour setting.

### Display colour setting

Press the or button to select the display colour.

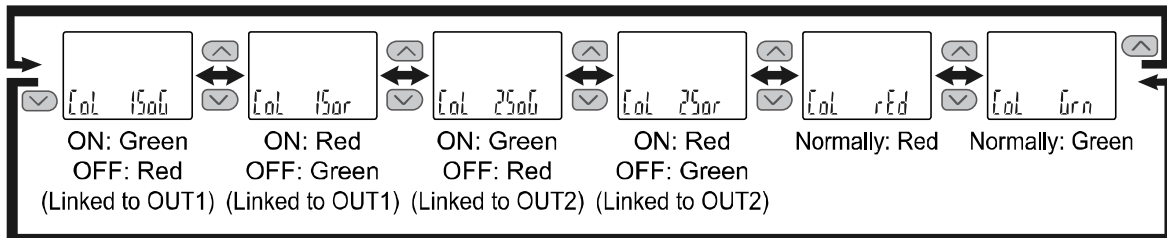
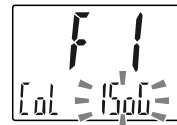

Press the button to set. Return to function selection mode.

[F 1] Setting of OUT1 completed

\*1: The selected item becomes valid after pressing the button.

\*2: After enabling the setting by pressing the button, it is possible to return to the measurement mode by pressing the button for 2 seconds or longer.

### Accumulated value setting

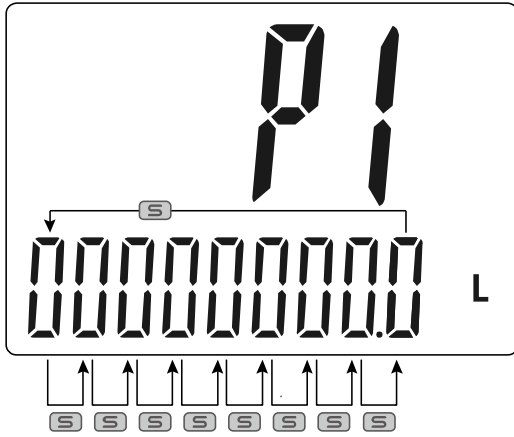

The sub screen displays the value, and all digit of the set value will start flashing.

Press the or button to blink the leftmost digit and enter the value. (The required accumulated value should be input one digit at a time).

Press the button to move on to input of the next right digit. Pressing the button again will select the next digit to the right.

After the input of the first 9 digits is complete, press the button for 1 second or longer.

[000000000] will start flashing.

Press the button again to confirm.

•List of output modes

Select the operation required from the table below. Characters in ( ) are for OUT2.

	Normal output	Reversed output
Hysteresis mode		
Window comparator mode		
Accumulated output mode (Increment)	<ul style="list-style-type: none"> <li>• Count up from "0".</li> <li>• Turn ON when the set value is reached.</li> <li>• Return to "0" by reset.</li> </ul>	<ul style="list-style-type: none"> <li>• Count up from "0".</li> <li>• Turn OFF when the set value is reached.</li> <li>• Return to "0" by reset.</li> </ul>
Accumulated output mode (Decrement)	<ul style="list-style-type: none"> <li>• Count down from set value.</li> <li>• Turn ON when the "0" is reached.</li> <li>• Return to set value by reset.</li> </ul>	<ul style="list-style-type: none"> <li>• Count down from set value.</li> <li>• Turn OFF when the "0" is reached.</li> <li>• Return to set value by reset.</li> </ul>
Accumulated pulse output mode		
Error output mode		
OFF mode		

\*: Applicable errors are Er1, 2, 6, and 8.

If the point at which the switch output changes is outside of the set flow rate range due to the selection of normal or reversed output, the hysteresis value will be automatically adjusted.

## ■[F 2] Setting of OUT2

Set the output mode of OUT2.

The output signal turns ON when the flow is greater than the set value.

Refer to the "List of output modes" on page 43 for the relationship between the set items and the operation.

### <Operation>

Press the or button in function selection mode to display [F 2].

Press the button. Move on to output mode setting.

**Output mode setting**

Press the or button to select the required output mode.

Press the button to set. Move on to reversed output setting.

**Reversed output setting**

Press the or button to select the reversed output.

Press the button to set. Move on to flow setting.

**Flow setting**

Set the flow based on the setting method on page 29.

Hysteresis mode: [P\_2]  
 Window comparator mode: [P2L] [P2H]  
 "P" is changed to "n" as [2\_P] → [2\_n] when reversed output is selected.  
 The snap shot function can also be used.  
 (Refer to page 71.)

[AC] When accumulated output is selected

Press the button to move on to accumulated output setting.  
 (Refer to page 42.)

[Err] Error output, [PLS] When pulse output is selected

Press the button to move on to display colour setting.

[OFF] Switch output OFF is selected.

Press the button to move on to display colour setting.

Press the button to set. Move on to hysteresis setting.

### Hysteresis setting

Set the flow referring to the setting method on page 29.



Hysteresis mode: [H\_2]  
Window comparator mode: [WH2]  
The snap shot function can also be used.  
(Refer to page 71.)

Press the **S** button to set. ↓ Move on to delay time setting.

### Delay time setting

The delay time of the switch output can be set by pressing the **▲** or **▼** button. Setting the Delay time can prevent the output from chattering.



Delay time settable range :0.00 to 60.00 [S]

Press the **S** button to set. ↓ Move on to display colour setting.

### Display colour setting

Press the **▲** or **▼** button to select the display colour.



<b>Col 15a0</b>	<b>Col 15ar</b>	<b>Col 25a0</b>	<b>Col 25ar</b>	<b>Col red</b>	<b>Col Grn</b>
ON: Green OFF: Red (Linked to OUT1)	ON: Red OFF: Green (Linked to OUT1)	ON: Green OFF: Red (Linked to OUT2)	ON: Red OFF: Green (Linked to OUT2)	Normally: Red	Normally: Green

Press the **S** button to set. ↓ Return to function selection mode.

[F 2] Setting of OUT2 completed

\*1: The selected item becomes valid after pressing the **S** button.

\*2: After enabling the setting by pressing the **S** button, it is possible to return to the measurement mode by pressing the **S** button for 2 seconds or longer.

([AC] When accumulated output is selected)

### Accumulated output setting

Press the or button to select accumulated output.

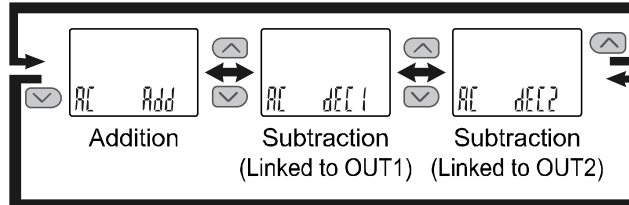

Press the button to set. Move on to accumulated value setting.

### Accumulated value setting

Perform the accumulated value setting (Refer to page 42.)

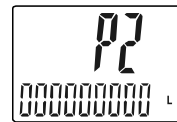

Press the button to set. Move on to display colour setting.

### Display colour setting

Press the or button to select the display colour.

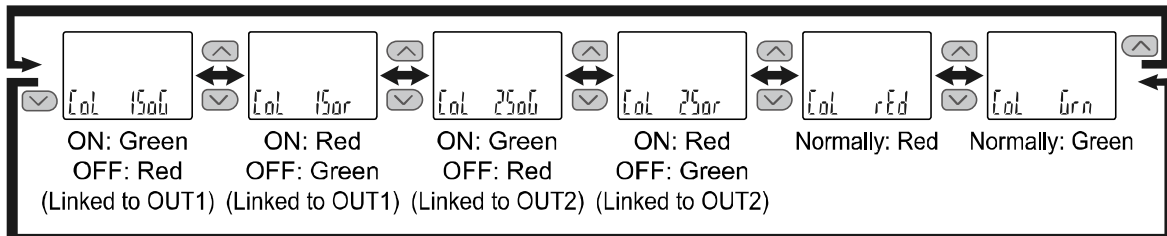
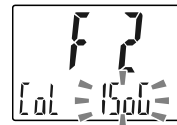

Press the button to set. Return to function selection mode.

[F 2] Setting of OUT2 completed

\*1: The selected item becomes valid after pressing the button.



\*2: After enabling the setting by pressing the button, it is possible to return to the measurement mode by pressing the button for 2 seconds or longer.



## ■[F 3] Digital filter setting

The digital filter can be selected to filter the flow measurement (0 to 30 sec.).



Output chattering or display flicker in measurement mode can be reduced by setting the digital filter.

### <Operation>

Press the  or  button in function selection mode to display [F 3].

Press the  button.  Move on to digital filter setting.

#### Digital filter setting

Press the  or  button to select the digital filter.

Digital filter set range: 0.00 to 30.00 [S]

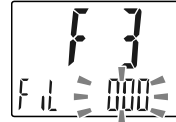

Press the  button to set.  Return to function selection mode.

[F 3] Digital filter setting completed

\*1: Each set value is a guideline for 90% response time.



\*2: The Switch output and flow display/analogue output are affected.



When only the switch output needs to be filtered, select and adjust the delay time setting. (page 40 and 45)

## ■[F 4] Auto-preset function setting



This function will automatically calculate and set the optimum pressure based on the actual operating condition, when hysteresis mode has been selected.

### <Operation>

Press the  or  button in function selection mode to display [F 4].

Press the  button.  Move on to Auto-preset function setting.

### Digital filter setting

Press the  or  button to select the auto-preset function.

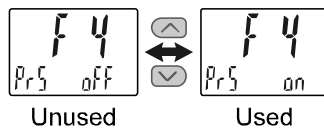
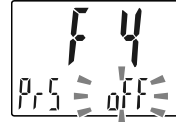

Press the  button to set.  Return to function selection mode.

[F 4] Auto-preset function setting completed

\*: If neither OUT1 nor OUT2 is in hysteresis mode, [---] is displayed and the auto preset function is not applicable.



●Auto-preset

When auto-preset is selected in function selection mode, the set value can be calculated and memorized from the measured flow. Repeating the suction and release of the workpiece to be set for several times will automatically optimize the set value.

(1) Selection of auto-preset OUT1 mode

Press the SET button in measurement mode to display [AP1 rEdy]. (If setting of OUT1 is not necessary, select [AP1 rEdy], and then press the UP and DOWN buttons simultaneously for 1 second or longer. The display will move to [AP2 rEdy]).



Auto Preset Ready State

(2) Preparation of equipment for OUT1

Prepare the equipment for which the flow of OUT1 is to be set.

(3) Setting of auto-preset for OUT1

Press the SET button to display [AP1 rUn] and [rUn] will flash. Measurement starts. Operate the device to change the flow. (If the UP and DOWN buttons are pressed simultaneously for 1 second or longer while "rUn" is displayed, measurement will be stopped and [AP2 rEdy] will return.)

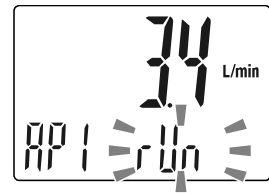

Auto preset measurement start

(4) Selection of auto-preset OUT2 mode

Press the SET button to set [P\_1], [H\_1] ([n\_1], [H\_1] in reverse output mode) to display [AP2 rEdy]. (If the setting of OUT1 is not necessary, press the UP and DOWN buttons simultaneously for 1 second or longer after [AP1 rEdy] display. The display will move to measurement mode).

(5) Preparation of equipment for OUT2

Prepare equipment for which the flow of OUT2 is to be set, and set the value of OUT2 as in OUT1. The [rUn] of [AP2 rUn] will be flash and measurement starts. (If the UP and DOWN buttons are pressed simultaneously for 1 second or longer while "AP1" is displayed, measurement will be stopped and measurement mode will return.)

(6) Complete setup

Press the SET button to set the set value of [P\_2] and [H\_2] and complete the auto-preset mode. Then, measurement mode returns. ([n\_2], [H\_2] in reverse output mode.)

The settings and hysteresis in auto-preset will be as follows.

Output type	Setting items	Calculation formula	A: Maximum measured auto-preset value
			B: Minimum measured auto-preset value
Normal	Set value	Calculated value = $A - \frac{A-B}{4}$	
Reverse			Calculated value = $B + \frac{A-B}{4}$
Normal Reverse	Hysteresis	Calculated value = $\frac{A-B}{2}$	

## ■[F 5] FUNC terminal function setting

Analogue output, external input or copy function can be selected.

\*: Do not connect the grey wire when changing the setting.

- When the analogue output is selected

When the product with analogue voltage output is used, the output of 1 to 5 V or 0 to 10 V can be selected. A flow value corresponding to 5 V (10 V) or 20 mA can be selected with the analogue output free range function.

- When the external input is selected

The Accumulated Flow, Peak Value and Bottom Value can be reset remotely by an external input signal.

- Accumulated flow external reset: A function to reset the accumulated flow value when an external input signal is applied.

In accumulated increment mode, the accumulated flow value will reset to zero, and then increase from zero.

In accumulated decrement mode, the accumulated flow value will reset to a set value, and then decrease from the set value.

\*: When the Accumulated Value has been stored to memory, every time the Accumulated Value External Reset is activated, the memory will be accessed. Take into consideration the maximum number of times the memory can be accessed is 1.5 million times.

When using the product, it should be considered that the total number of external input resets and accumulated values stored must not exceed 1.5 million cycles.

- Peak/Bottom value reset: A function to clear the peak value or bottom value in response to an external input signal.

- When the copy function is selected

The set value of the monitor copy source can be copied.

**<Operation>**

Press the or button in function selection mode to display [F 5].

Press the button. Moves on to FUNC terminal function setting.

**FUNC terminal function setting**

Press the or button to select the required function.

**Analogue voltage output**

[oUt] (Analogue output)

Press the button to move on to analogue output setting.

**External input [in]**

Press the button to move on to external input setting.

**Analogue current output**

[oUt] (Analogue output)

Press the button to move on to free range setting.

**Copy [CoPY]**

Press the button to set.

Return to function selection mode.

**Analogue output setting**

Press the or button to select the required analogue output.

1-5 V      0-10 V

**External input setting**



Press the or button to select the required external input.

Reset accumulated value      Peak/bottom value reset

Press the button to set.  
Move on to free range setting.

Press the button to set.  
Return to function selection mode.

### Free range setting

Press the  or  button to select the free range setting.

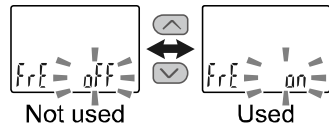



[on] is enabled

Press the  button to move on to set value.

[oFF] not used

Press the  button to set.  
Return to function selection mode.

### Set value

Use the  and  buttons to enter the flow value to correspond with the full span analogue output (5 V or 10 V or 20 mA).

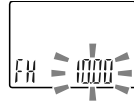

The entered flow value can be in the range: 10% of the maximum rated flow, to the max. displayable range.

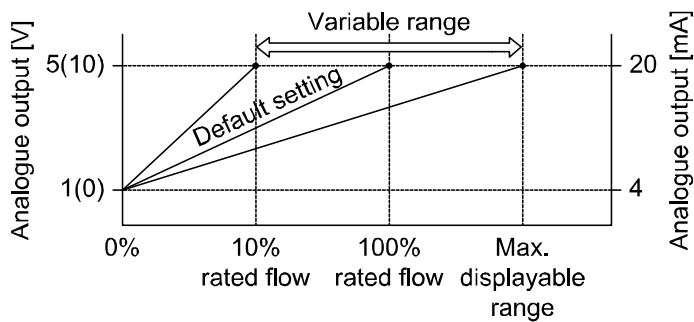

Press the  button to set.

Return to function selection mode.

[F 5] FUNC terminal function setting completed

## ■[F10] Sub display setting

Change the display style of the sub display.

- Initial setting (standard): Accumulated value, set value for OUT, peak value, or bottom value is displayed.
- Addition of line name: A line name can be added to the default display.  
A line name can be entered comprising of up to 5 characters and/or numbers.
- Setting of display off: Display off can be set for the default display.

\*: Addition of line name and the display off cannot be set at the same time.

Detailed settings are shown in the pages from 54.

### <Operation>

Press the or button in function selection mode to display [F10].

Press the button. Move on to sub display setting.

#### Sub display setting

Press the or button to select the required sub display style.

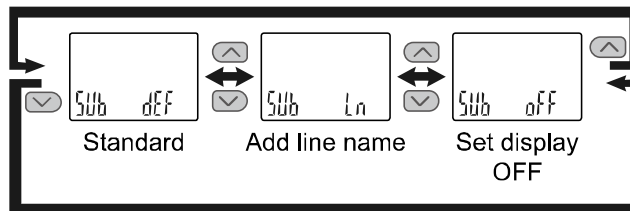

When [Ln] Addition of line name is to be added  
Press the button to move on to input of line name.

#### Input of line name

Function to display the specified character string on the sub display.

Press the or button to input the line name to be displayed on the sub display (right).  
Press the button to make the next digit to the right flash. Input the line name.

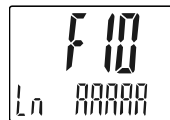

(The most significant digit flashes when the button is pressed at the least significant digit).

The order of displayed characters is A → b → ... → Y → (Z) → 0 → 1 → ... → 9 → symbol → space.

(Characters which can be displayed are different for 1 digit on the left and 5 digits on the right).

The set line name flashes by pressing the button for 1 second or longer.

(At this point, the setting of the line name is not complete.)

Setting of [dEF] default, or [oFF] display OFF

Press the button to set. Return to function selection mode.

Press the button to set. Return to function selection mode.

[F10] Sub display setting completed

•Characters which can be displayed for each digit are as follows.  
 Characters Q, X, Z, /, or \* cannot be displayed.

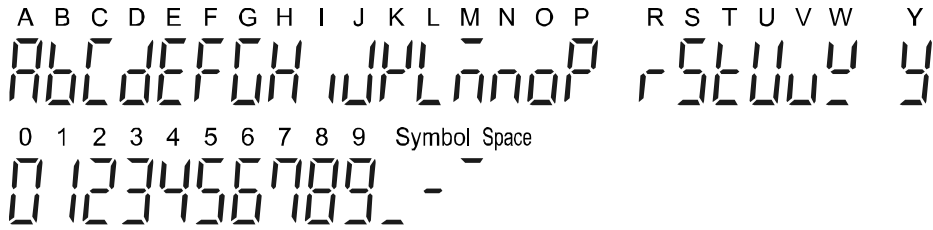

<Sub display>

•Standard

The Standard display function displays the items and values on the sub display.  
 The displayed item varies depending on the setting of the output mode. Select the displayed items by pressing the or button in measurement mode.

(Hysteresis mode, error output, switch output off)

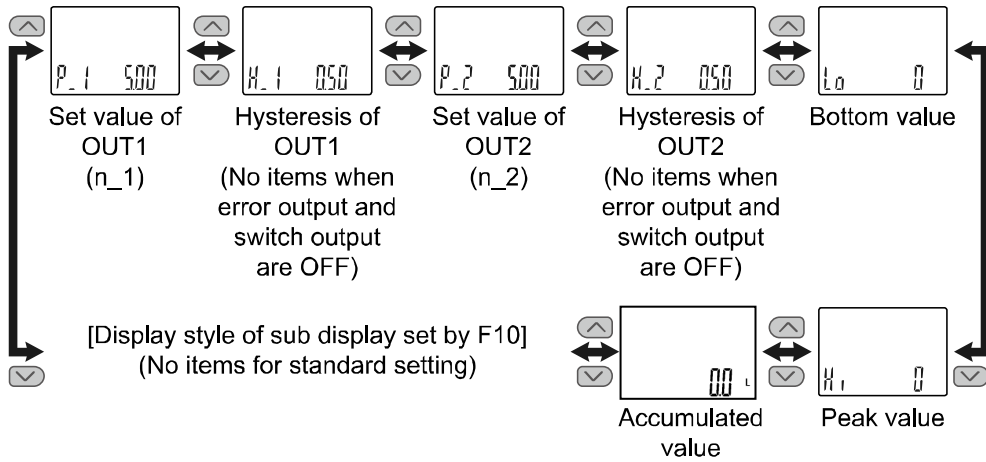

(Window comparator mode)

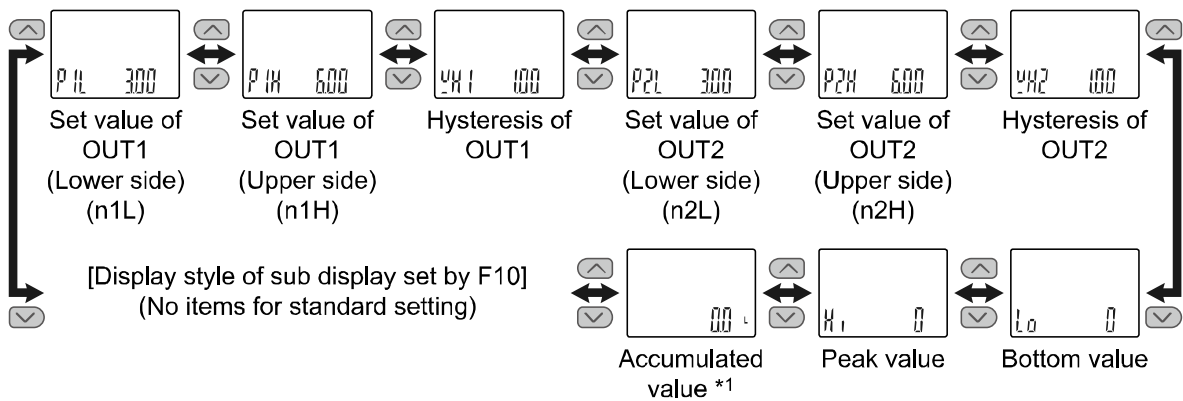

\*1: The accumulated value display first shows the accumulated display value label (AC), followed by the accumulated value after 1 second.

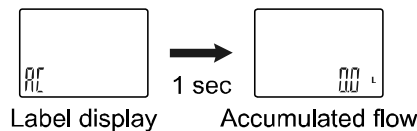





## ■[F11] Display resolution setting

This function is only available for the 1, 10 and 100 L/min types.



The minimum setting unit can be changed by selecting the display resolution.

### <Operation>

Press the  or  button in function selection mode to display [F11].

Press the  button.  Move on to display resolution setting.

### Display resolution setting

Press the  or  button to select the display resolution.

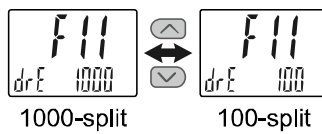



Press the  button to set.  Return to function selection mode.



[F11] Display resolution setting completed

## ■[F14] Display with zero cut-off setting



When the flow is close to 0 L/min., the product rounds the value down and zero will be displayed. This is adjustable within the range of  $\pm 10\%$  F.S. of the flow range.

<Operation>

Press the  or  button in function selection mode to display [F14].

Press the  button.  Move on to display with zero cut-off setting.

### Display with zero cut-off setting

Press the  or  button to select the display zero-cut setting.







No zero-cut off



$\pm 0.9\%$ F.S.  
Cut



$\pm 1.0\%$ F.S.  
Cut



$\pm 1.1\%$ F.S.  
Cut



$\pm 9.9\%$ F.S.  
Cut



$\pm 10\%$ F.S.  
Cut

\*: The display above is an example when 10 L/min flow range is selected.  
 \*: When the actual flow is smaller than the displayed value in the upper line, zero will be displayed.  
 \*: If the displayed zero-cut range does not match the minimum display unit due to the set value, the fraction is rounded up.

Example: Flow range 10 L/min

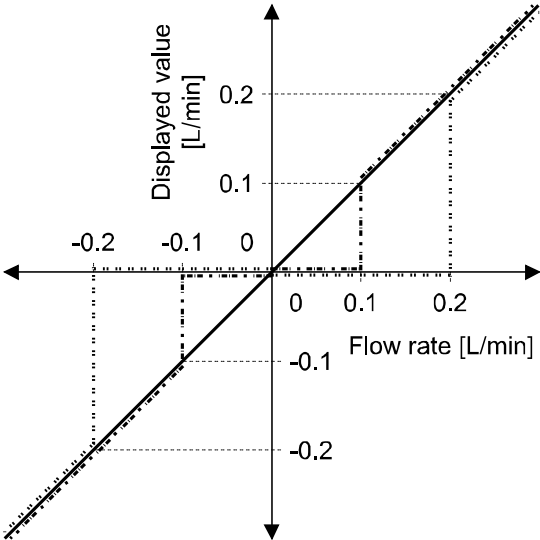

— CUT: 0.0 (No zero-cut off)

- - - CUT: 1.0 (1%F.S.or less is cut to zero)

· · · · · CUT: 2.0 (2%F.S.or less is cut to zero)

Press the  button to set.  Return to function selection mode.

### [F14] Display with zero cut-off setting completed

\*: Zero-cut range of the accumulated value and accumulated pulse should be 1%F.S. or more. However, please note that if the zero-cut setting value is 0.0, any value below 1%F.S. will be cut to zero.

\*: When setting the flow value and hysteresis within the zero cut-off settable range, the on-off point varies depending on the settable range.

For further details, refer to "When the switch output (OUT) and hysteresis are set within Zero cut-off range (page 57).

\*: In the minus (-) direction, down to -5% F.S. is the range for zero-cut off. [LLL] is displayed when the range is exceeded.



- When the set value and hysteresis of the switch output (OUT) is set within the zero-cut range. The operating point of the switch output will be changed, depending on the zero-cut setting value. However, please note that the set value and hysteresis of the switch output will not be changed. To maintain the on-off point, set the value and hysteresis without the zero cut-off range.

<Example: Flow range 3000 L/min>

Common setting

Output mode	Hysteresis mode
Switch operation	Normal output
Set value (P)	0.50
Hysteresis (H)	0.30

### Initial setting

Zero cut-off setting CUT: 1.0 (displays 0 for a value below 0.10 L/min)

Switch ON point	0.50 L/min or more
Switch OFF point	Below 0.20 L/min

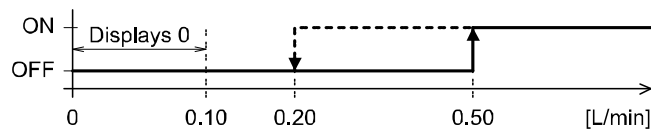

↓ Change the zero cut-off setting.  
The set value (P) and hysteresis (H) cannot be changed.

### ~Condition when the operating point of hysteresis(H) is changed~

- The zero-cut setting CUT: 1.0 will be changed to CUT: 3.0. (0 will be displayed for a value below 0.30 L/min)

Switch ON point	0.50 L/min or more
Switch OFF point	Below 0.30 L/min (0 is displayed)

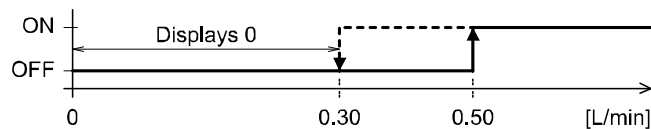

### ~Condition when the operating point of the set point (p) and hysteresis (H) is changed~

- The zero-cut setting CUT: 1.0 will be changed to CUT: 6.0. (0 will be displayed for a value below 0.60 L/min)

Switch ON point	0.60 L/min or more
Switch OFF point	Below 0.60 L/min (0 is displayed)

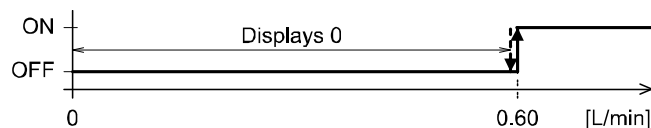

## ■[F30] Accumulated value hold setting

This function enables the accumulated flow value to be stored in permanent memory every 2 or 5 minutes. In the default setting, the accumulated flow value is not held when the power supply is turned off.

\*: When using the accumulated value hold function, calculate the product life from the operating conditions, and use the product within its life.



Maximum updating time of the accumulated value is 1.5 million times.



If the product is operated 24 hours per day, the product life will be as follows:

- Data memorized every 5 minutes --- 5 minutes x 1.5 million times = 7.5 million minutes = 14.3 years
- Data memorized every 2 minutes --- 2 minutes x 1.5 million times = 3 million minutes = 5.7 years



If the accumulated flow external reset is also repeatedly used, the product life will be shorter.

### <Operation>

Press the  or  button in function selection mode to display [F30].

Press the  button.  Move on to accumulated value hold setting.

### Accumulated value hold setting

Press the  or  button to select the storage cycle of the accumulated value.



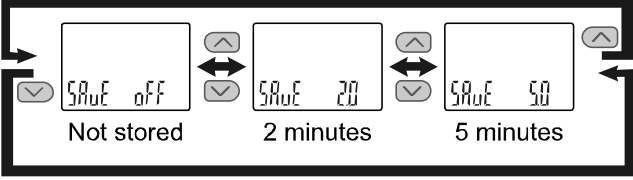

Press the  button to set.  Return to function selection mode.

[F30] Accumulated value hold setting completed

\*: The value is stored in memory every 2 or 5 minutes. If the power supply is turned off, the accumulated flow since the last time it was stored will be lost.

\*: When the power supply is turned on again, the accumulated flow count will start from the last value recorded at B.

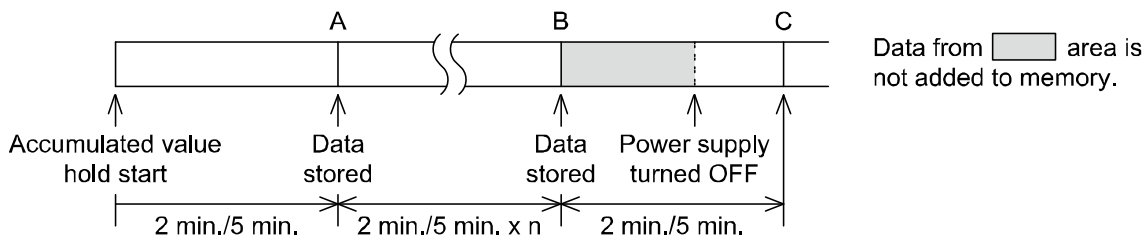





## ■[F80] Power saving mode

Power saving mode can be selected.



When selected, if no buttons are pressed for 30 seconds, the product will shift to power saving mode.

### <Operation>

Press the  or  button in function selection mode to display [F80].

Press the  button.  Move on to power saving mode.

### Power saving mode

Press the  or  button to select the power saving mode.

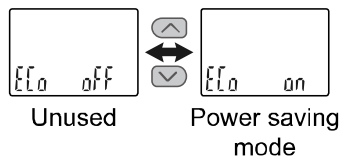

Press the  button to set.  Return to function selection mode.

[F80] Power saving mode completed

In power saving mode, when buttons are pressed the display is normal, but if no buttons are pressed for 30 seconds, it will revert to power saving mode (Power saving is only available in measurement mode).

During power saving mode, [ECo] will flash in the sub display and the operation LED is ON (when the switch is ON).

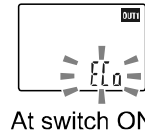

At switch ON





At switch OFF

\*: There may be a difference in the displayed value between the connected flow switch and the flow monitor.  
When the flow switch display is used, it is recommended to set the flow switch display OFF mode.

## ■[F81] Security code



The security code can be turned on or off and the security code can be changed when unlocked.

### <Operation>

Press the  or  button in function selection mode to display [F81].

Press the  button.  Move on to security code.

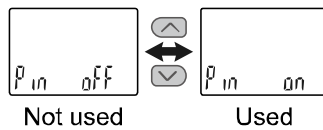

#### Security code

Press the  or  button to select the setting of security code.



Press the  button to set.  Move on to security code checking.

#### Security code checking

Press the  or  button to input the security code on the sub display (right).  
(The default setting is [000].)\*



For instructions on how to enter the security code, refer to "How to input and change the security code" on page 74.

If the security code entered is incorrect, [FAL] will be displayed, and the security code must be entered again.



If an incorrect security code is entered 3 times, [nG] will be displayed and the device will return to function selection mode.

[oFF] (not used) is selected.

Press the  button to return to function selection mode.

Press the  button for 1 second to set.  Move on to changing the security code.



### Changing the security code

Press the  or  button to enter the changed security code on the main display. \*  
For instructions on how to enter the security code, refer to "How to input and change the security code" on page 74.

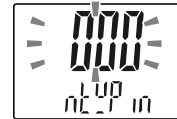

After entry, the new security code will flash by pressing the  button for 1 second (At this point, the changing of the security code is not completed).



Return to the change of setting again by pressing the  or  button.

Press the  button for 1 second to set. Return to function selection mode.

[F81] Security code completed



If the security code function is enabled, it will be necessary to enter a security code to release the key-lock.

\*: If a key is not pressed for 30 seconds while entering the security code, function selection mode will return.

## ■[F90] Setting of all functions

All functions can be set in turn.



### <Operation>

Press the  or  button in function selection mode to display [F90].

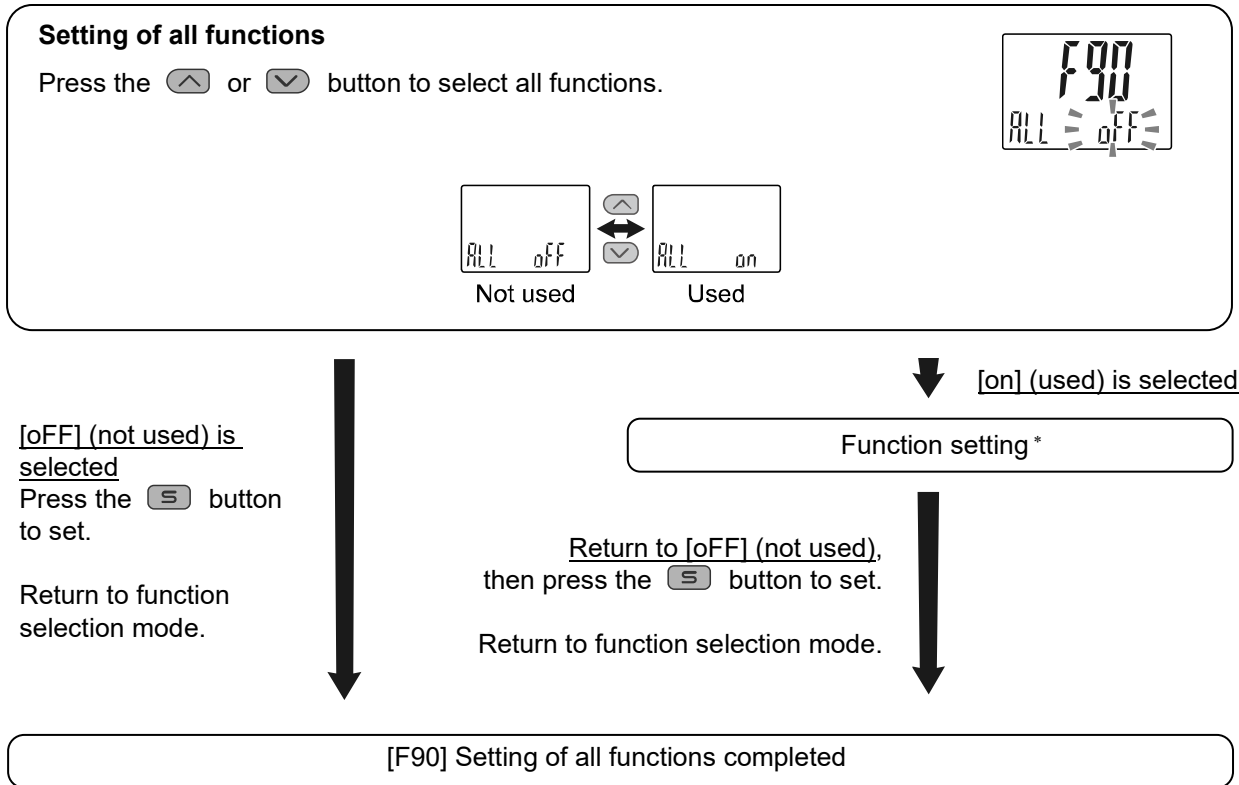
Press the  button.  Move on to setting of all functions.



\*: Setting of each function

Every time the  button is pressed, the display moves to the next function in order of "Setting of each function" on page 63. Set by using the  and  buttons.

For details of how to set each function, refer to the relevant section in this manual.

\*: Measurement mode can be returned from any setting items by pressing and holding the  button for 2 seconds or longer.

\*: The function setting from before returning to the measurement mode will be maintained.

●Setting of each function

Order	Function
1	Flow range setting
2	Fluid setting
3	Display unit setting
4	Switching setting of switch output NPN/PNP specifications
5	Output mode setting of OUT1
6	Reversed output setting of OUT1
7	Flow setting of OUT1
8	Hysteresis setting of OUT1
9	Delay time setting of OUT1
10	Display colour setting
11	Output mode setting of OUT2
12	Reversed output setting of OUT2
13	Flow setting of OUT2
14	Hysteresis setting of OUT2
15	Delay time setting of OUT2
16	Display colour setting
17	Digital filter setting
18	Auto-preset function setting
19	FUNC terminal function setting
20	Analogue voltage output Setting
21	Analog free-range switching setting
22	Analog free-range set value input
23	Sub display setting
24	Display resolution setting
25	Display with zero cut-off setting
26	Accumulated value hold setting
27	Power saving mode
28	Security code

\*: Measurement mode can be returned from any setting item by pressing the  button for 2 seconds or longer.



\*: Functions set before returning to the measurement mode are maintained.



\*: Only the corresponding settings are displayed.

## ■[F96] Sensor input/External input signal status display

The sensor input signal (1 to 5 V or 4 to 20 mA) and the external input signal can be checked.

### <Operation>

Press the  or  button in function selection mode to display [F96].

Press the  button.  Move on to sensor input/external input signal status display.

### Sensor input/External input signal status display

Select to display the sensor input or external input signal condition by pressing the  button.

\*: Only the sensor input can be displayed if the external input signal [F 5] is not set.

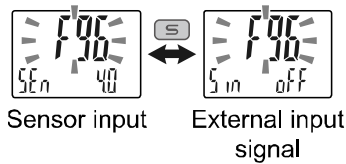



## ■[F97] Copy setting

The set values can be copied. When the input specification, output specification and the units specification are the same, this function is available.

The set value can be copied to up to 10 flow monitors simultaneously.

### <Connection>

Connect the flow monitors together with the power supply turned off.

Connect the FUNC terminals of the copy source flow monitor and the copy destination flow monitors, and then turn on the power supply.

The copy source flow monitor is the monitor from which the setting is to be copied.

The copy destination flow monitor is the monitor to which the setting is to be copied.

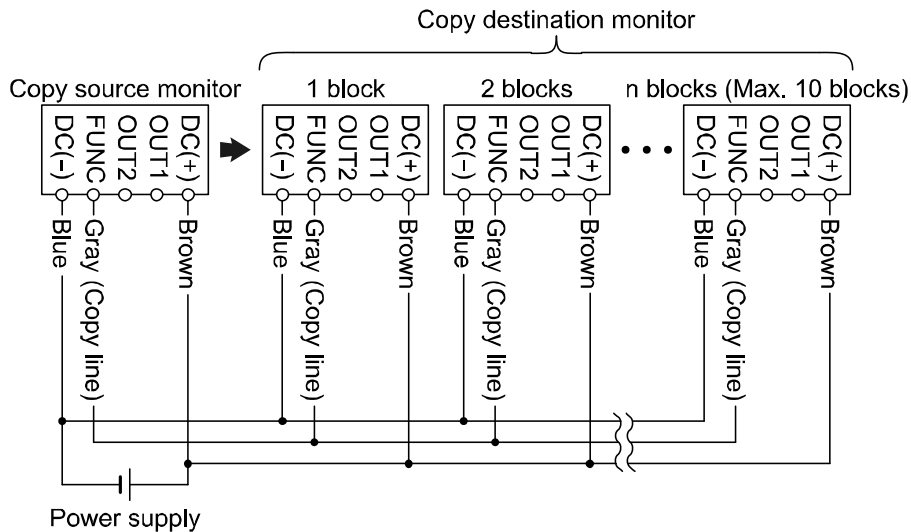

### <Operation>

Press the or button of the copy source flow monitor in function selection mode to display [F97].

Press the button. Move on to copy setting.

#### Copy setting

Press the or button to select the copy function.

[onL]: Copy destination is key-locked after copying

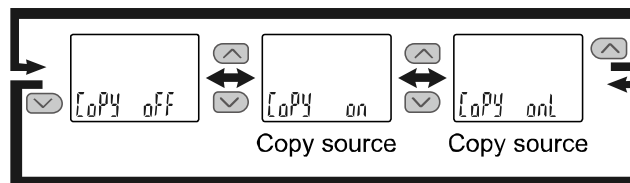

When [on] [onL] (Copy source) is selected  
Press the button to move to the screen to start copying.

[oFF] (not used) is selected.  
Press the button to set.

Return to function selection mode.

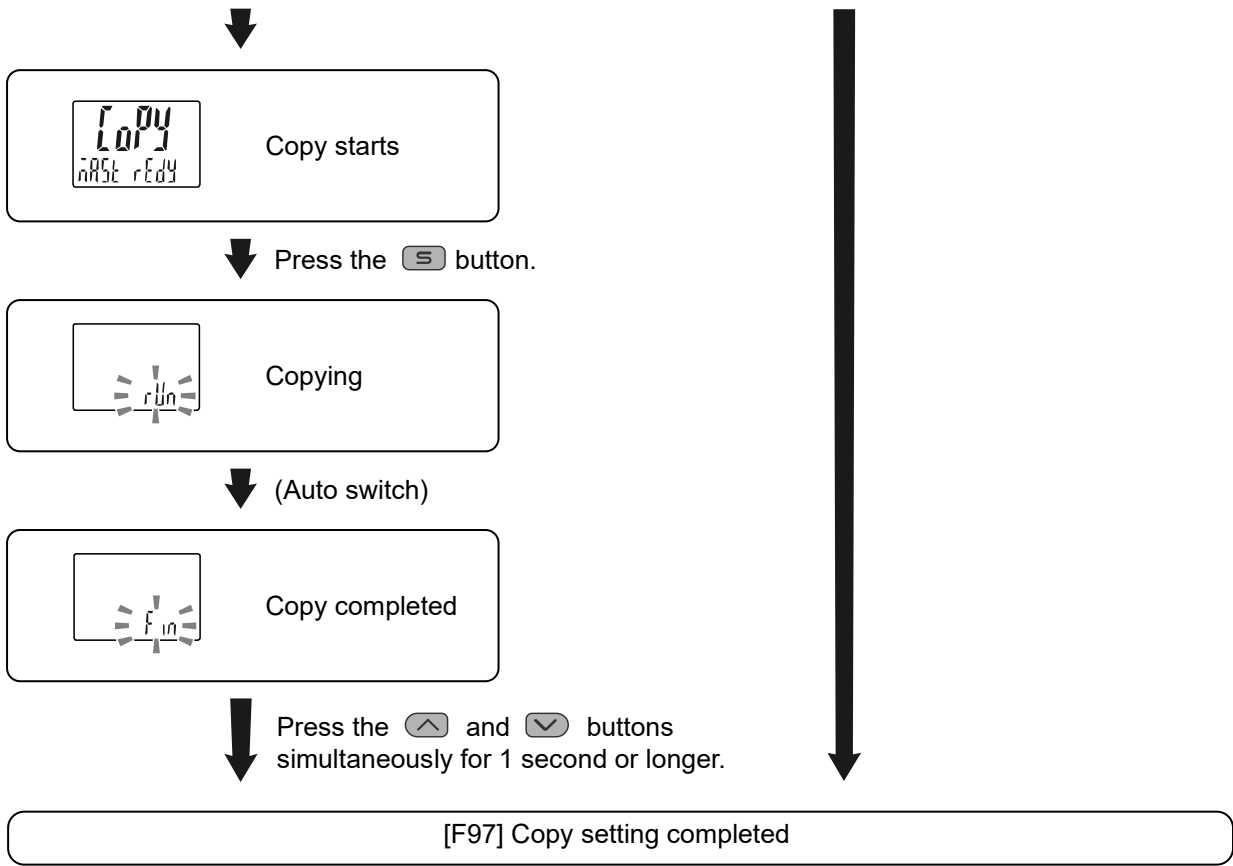

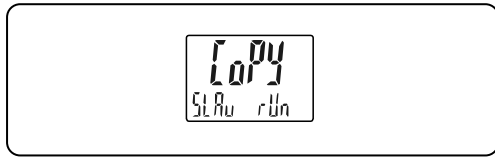

After selecting the copy source, all other connected monitors switch to copy destination.

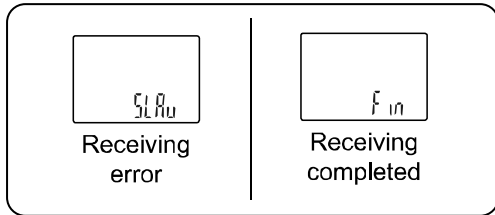

↓ (Auto switch)





↓ Press the  and  buttons simultaneously for 1 second or longer.

End

## ■[F98] Output check



The switch output or analogue output can be selected for an output check.  
The output can be turned ON/OFF manually for checking.

### <Operation>

Press the  or  button in function selection mode to display [F98].

Press the  button.  Move on to output check.

### Output check

Press the  or  button to select output check.

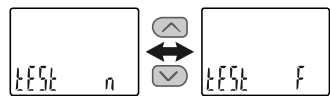

Normal output  
(Output not  
checked)

Forced output  
(Output is  
checked)

When [F] (Forced output) is  
selected.

Press the  button to set. 

When [n]  
(Normal output)  
is selected.

Press the  
 button  
to set.

Return to  
function  
selection mode.

### OUT1 output check

Press the  or  button to select OUT1  
output check.

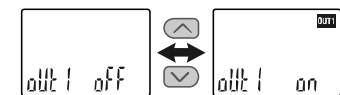

Forced output  
OFF

Forced output  
ON

Press the  button to set. 

### OUT2 output check

Press the or button to select OUT2 output check.

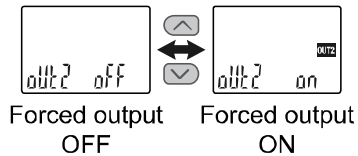

When switching of analogue output is selected for the setting of [F 5] FUNC terminal function  
Press the button to move on to FUNC terminal function setting.

### FUNC terminal function setting

Press the or button to select the analogue output.

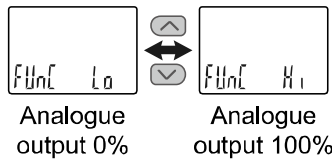

When external input or copy function is selected for the setting of [F 5] FUNC terminal function.  
Press the button to set.  
Return to function selection mode.

Press the button to return to [n] (normal output), then press the button to set.

Return to function selection mode.



[F98] Output check completed



\*: Measurement mode can be returned from any setting by pressing the button for 2 seconds or longer.

## ■[F99] Reset to default settings





If the product settings have become uncertain, the default values can be restored.

### <Operation>

Press the  or  button in function selection mode to display [F99].

Press the  button.  Move on to reset to default settings.

#### Reset to default settings

Press the  or  button to display [ON], then press the  and  buttons simultaneously for 5 seconds or longer.

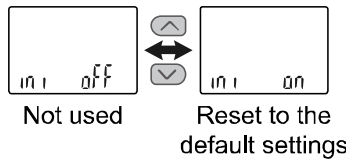

[oFF] (not used) is selected.  
Press the  button to set.

Return to function selection mode.

All settings are returned to the default values.

Return to function selection mode.

[F99] Reset to default settings completed

## Other Settings

### ○ Snap shot function

The current flow value can be stored to the switch output ON/OFF set point.

When the items of sub display (left) below are selected in 3 step setting mode, simple setting mode or function selection mode ([F 1] Setting of OUT1, [F 2] Setting of OUT2), by pressing the  $\triangle$  and  $\nabla$  buttons simultaneously for 1 second or longer, the value of the sub display (right) shows [- -], and the values corresponding to the current flow values are automatically displayed.

Output mode	Configurable items	Sub display (left)	Snap shot function
Hysteresis mode	Set value	$P_{-1} (n_{-1}) / P_{-2} (n_{-2})$	○
	Hysteresis	$H_{-1} / H_{-2}$	○
Window comparator mode	Set value	$P_{1L} (n_{1L}), P_{1H} (n_{1H}) / P_{2L} (n_{2L}), P_{2H} (n_{2H})$	○
	Hysteresis	$H_{1L} / H_{1H}$	×
Accumulated output mode	Set value	$P_1, P_2, n_1, n_2$	×

#### • Set value

The value is set to the same value as the display value (current flow value).

(There is a range which cannot be set to the current flow depending on the hysteresis. In that case, the value is set to the closest value.)

#### • Hysteresis

The hysteresis is calculated from the equation below and set.

Normal output: (set value) - (current flow value)
Reverse output: (current flow value) - (set value)

If the calculation result becomes 0 or less, [Err] is displayed on the sub display (right) and the set value is not changed.

Afterwards, it is possible to adjust the value by pressing the  $\triangle$  or  $\nabla$  button.

### ○ Peak/bottom value indication

The maximum (minimum) flow when the power is supplied is detected and updated.

In peak/bottom indication mode, the current flow is displayed.

Press the  $\triangle$  or  $\nabla$  button in measurement mode to switch the sub-display (left) to the display shown below.

Peak/bottom values are displayed on the sub display (right) at the same time as the current flow value on the main display.

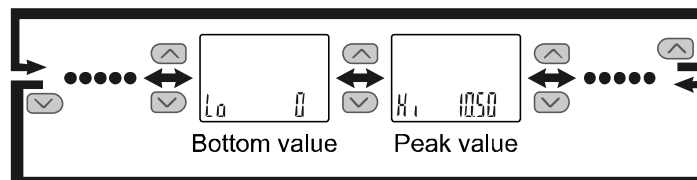

### ○ Reset

When the  $\text{S}$  and  $\nabla$  buttons are pressed for 1 second or longer simultaneously while the accumulated flow/peak/bottom values are displayed, the sub display (right) displays [---] and the display values are cleared.

### ○Key-lock function

The key-lock function is used to prevent errors occurring due to unintentional changes of the set values. If the **[S]** button is pressed while the keys are locked, [LoC] is displayed on the sub display (right) for approximately 1 second.

(Each setting and peak/bottom values are displayed with **[^]** and **[v]** buttons.)

#### <Operation - Without security code input ->

(1) Press the **[S]** button for 5 seconds or longer in measurement mode. When [oPE] is displayed on the main display, release the button.

The current setting [LoC] or [UnLoC] will be displayed on the sub display.

(To release key-lock repeat the above operation.)

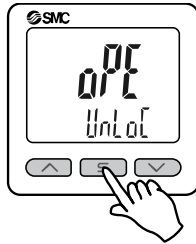

(2) Select the key-locking/un-locking with **[^]** or **[v]** button, and press the **[S]** button to set.

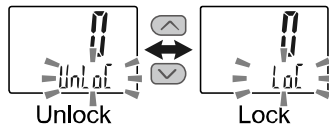



## <Operation – With security code input ->

### •Locking

- (1) Press the **[S]** button for 5 seconds or longer in measurement mode. When [oPE] is displayed on the main display, release the button.

The current setting [LoC] or [UnLoC] will be displayed on the sub display.

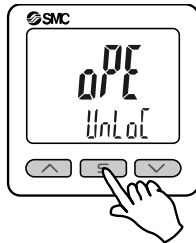

- (2) Select the key [LoC] with **[↑]** or **[↓]** button, and press the **[S]** button to set.

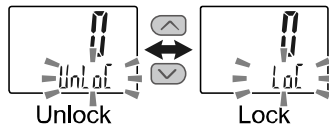

### •Unlocking

- (1) Press the **[S]** button for 5 seconds or longer in measurement mode. When [oPE] is displayed on the main display, release the button.

The current setting [LoC] or [UnLoC] will be displayed on the sub display.

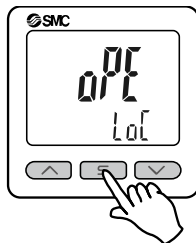

- (2) Select [UnLoC] to unlock with the **[↑]** or **[↓]** button. Setting is recognized by pressing the **[S]** button, then the security code is required.

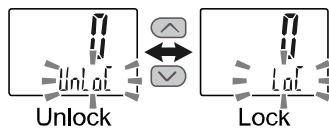

- (3) For instructions on how to enter the security code, refer to "How to input and change the security code" on page 74.

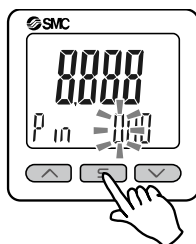



- (4) If the security code entered is correct, the main display will change to [UnLoC], and pressing one of **[↑]**, **[S]** or **[↓]** button releases the key-lock and the measurement mode returns.  
If the security code entered is incorrect, [FAL] will be displayed, and the security code must be entered again. If an incorrect security code is entered 3 times, [LoC] is displayed and the device returns to measurement mode.

● **How to input and change the security code**

The left most digit starts flashing.

Press the  or  button to select a value.

Press the  button to make the next digit to the right flash.

(If the  button is pressed at the last digit, the first digit will start flashing).

After the setting is complete, Press and hold the  button for 1 second or longer.

(If an operation is not performed for 30 seconds during input or change of the security code, the product will return to measurement mode).

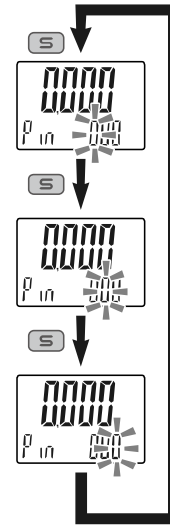

## Maintenance

### **How to reset the product after a power cut or forcible de-energizing**

The setting of the product will be retained as it was before a power cut or de-energizing. The output condition is also basically recovered to that before a power cut or de-energizing, but may change depending on the operating environment. Therefore, check the safety of the whole installation before operating the product. If the installation is using accurate control, wait until the product has warmed up (approximately 10 to 15 minutes).

## Forgotten security code

If you have forgotten your security code, please contact SMC directly.

# Troubleshooting

## ○ Troubleshooting

When any failure occurs with this product, the following chart can be used to identify the cause of the failure. If a cause applicable to the troubles cannot be identified and normal operation is recovered by replacement with a new product, this indicates that the product itself was faulty. Problems with the product may be due to the operating environment (installation etc). Please consult SMC.

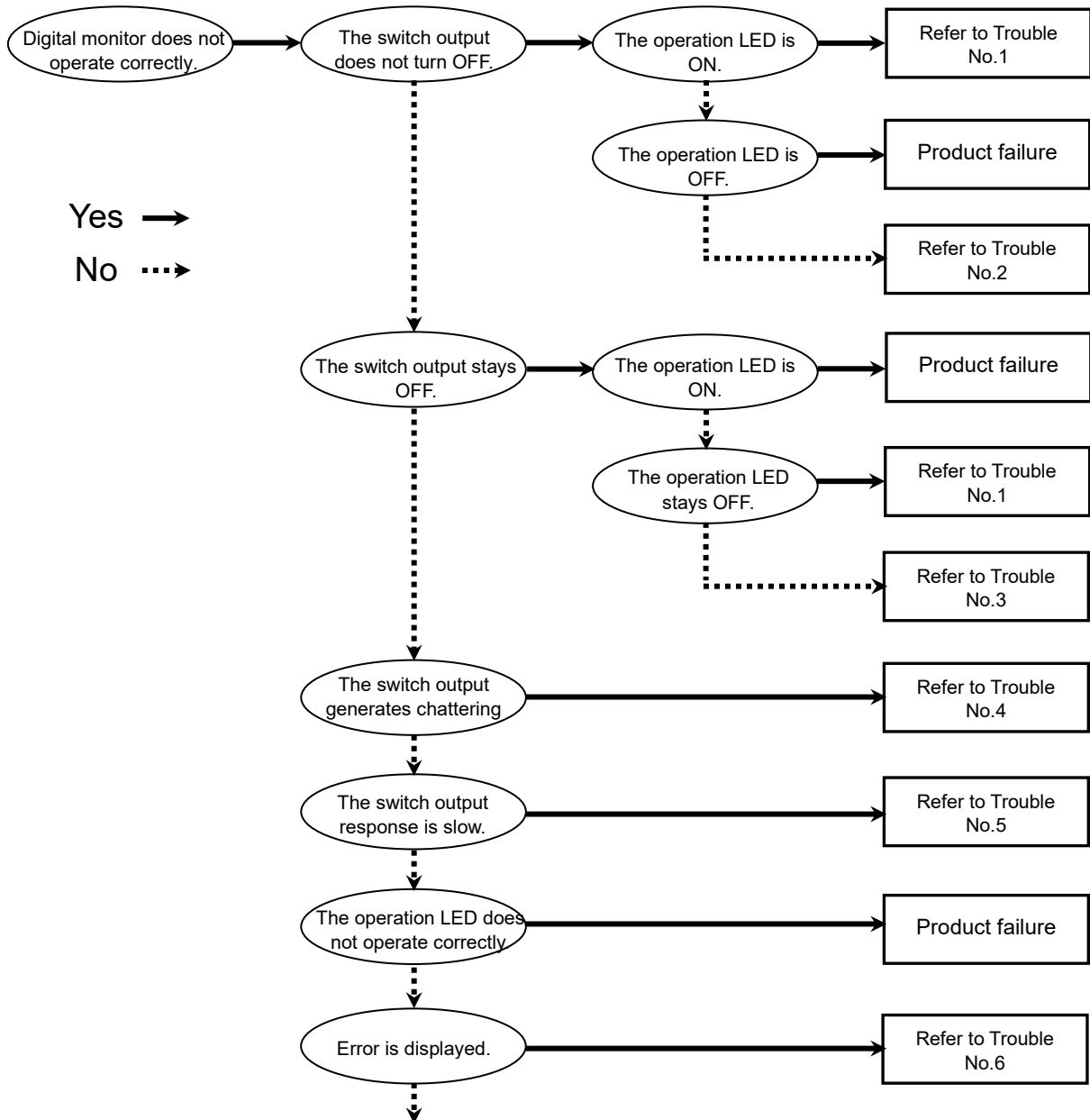

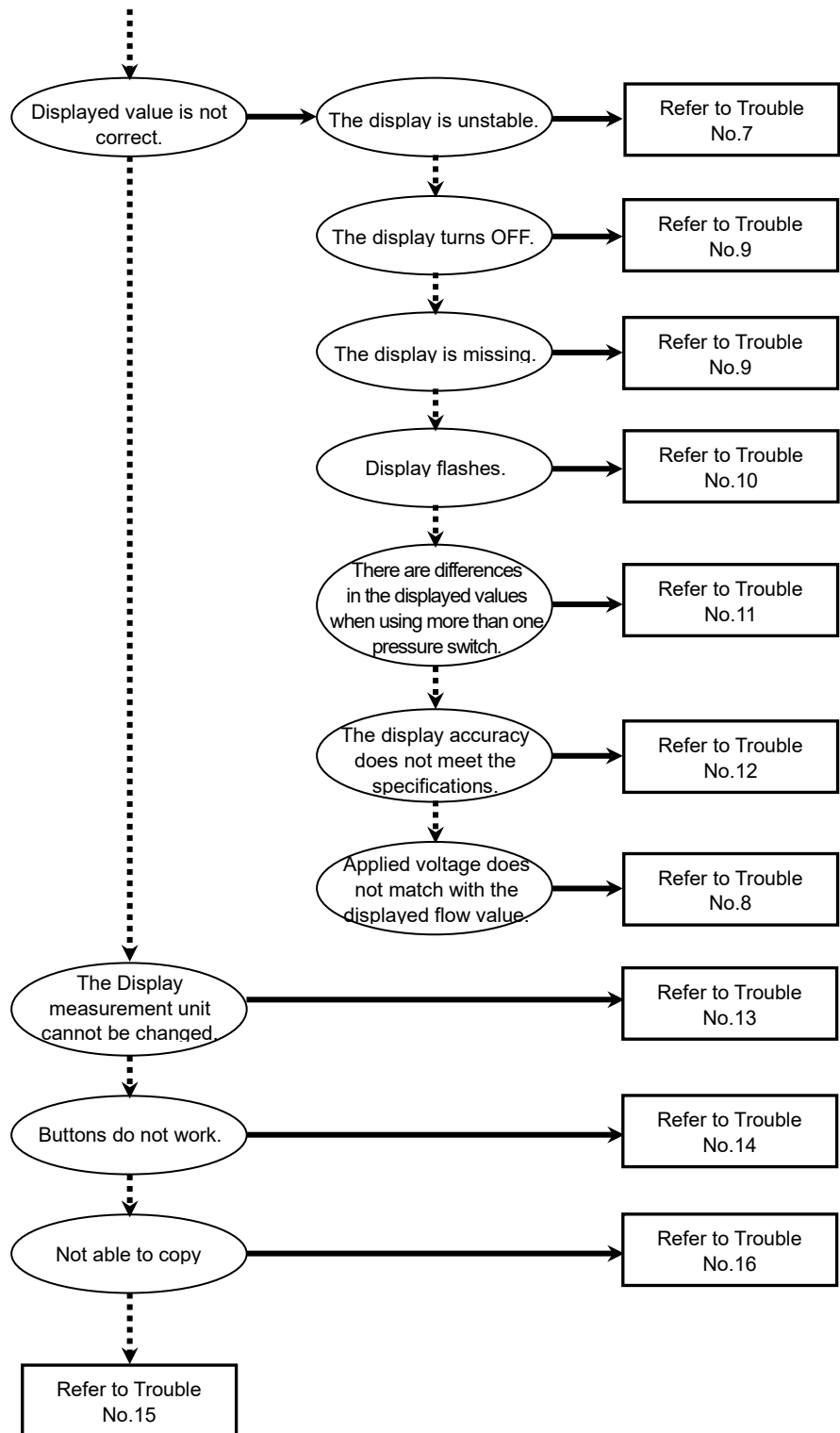

○Troubleshooting

Problem No.	Problem	Possible cause	Investigation method	Countermeasures
1	<ul style="list-style-type: none"> <li>•The switch output does not turn OFF. The operation LED stays ON.</li> <li>•The switch output does not turn ON. The operation LED stays OFF.</li> </ul>	Incorrect flow setting	(1) Check the set flow value. (2) Check the settings of the operation mode, hysteresis and output type. (Hysteresis mode/Window comparator mode/Accumulated output mode/Accumulated pulse mode/Error detection mode/Output OFF mode, normal output/reversed output can be selected)	(1) Adjust the set flow value. (2) Set the operation mode, hysteresis and output type again.
		Product failure		Replace the product.
2	The switch output does not turn OFF. The operation LED is normal.	Incorrect wiring	Check the output wiring. Check if the load is directly connected to DC(+) or DC(-).	Check and correct the wiring.
		Product failure		Replace the product.
3	The switch output is OFF. The operation LED is normal.	Incorrect wiring	Check the output wiring. Check if the load is directly connected to DC(+) or DC(-).	Check and correct the wiring.
		Incorrect SW output specification setting	Check the SW output specification setting. Check if the SW output is PNP while NPN is intended to be set, and vice versa.	Set the SW output specification again.
		Lead wire broken	Check if there is bending stress applied to any part of the lead wire. (bending radius, tensile force to the lead wire)	Correct the wiring. (Reduce the tensile force or increase the bending radius.)
		Product failure		Replace the product.
4	The switch output generates chattering.	Incorrect wiring	Check the wiring. Check if the brown and blue wires are connected to DC(+) and DC(-) respectively, and if the output line is secure (contact failure).	Correct the connection on the power cord and the plug.
		Incorrect flow setting	(1) Check the set flow value. (2) Check if the hysteresis range is small. (3) Check the delay time setting. Check if the delay time is too short.	(1) Adjust the set flow value. (2) Make the hysteresis wider. (3) Set the delay time again.
		Product failure		Replace the product.
5	The switch output response is slow.	Delay setting time is too long	Check if the time set for delay or digital filter is too long.	Reset the set value for delay time or digital filter.

Problem No.	Problem	Possible cause	Investigation method	Countermeasures
6	<ul style="list-style-type: none"> <li>•Over current error (Er1,2) is displayed.</li> <li>•COPY receiving error (Er13) is displayed.</li> <li>•System error (Er0, 4, 6, 8, 40) is displayed.</li> <li>•"HHH" is displayed.</li> <li>•"LLL" is displayed.</li> </ul>	Excess current was applied to the output (Er1,2)	<ol style="list-style-type: none"> <li>(1) Check if the output current is 20 mA or more.</li> <li>(2) Check if the connected load complies with the specification. Check if the load is short circuited.</li> <li>(3) Check if the relay without surge protection is connected.</li> <li>(4) Check if the wiring is in the same route as (or bundled together with) a high-voltage or power line.</li> </ol>	<ol style="list-style-type: none"> <li>(1)(2) Connect the appropriate load.</li> <li>(3) Use a relay with a surge voltage suppressor or take measures to prevent surge.</li> <li>(4) Separate the wiring from the high-voltage and/or power line.</li> </ol>
		Copy function operated incorrectly (Er13)	Check the wiring. Check if the brown and blue wires are connected to DC(+) and DC(-) respectively and the grey wires to each monitor are connected, and that the wiring is secure.	Correct the wiring.
		Incorrect internal data processing of the product (Er0,4,6,8,40)	<ol style="list-style-type: none"> <li>(1) Check if there is noise interference (such as static electricity). Check if there is a noise source nearby.</li> <li>(2) Check if the power supply voltage is in the range 12 to 24 VDC <math>\pm 10\%</math>.</li> </ol>	<ol style="list-style-type: none"> <li>(1) Remove the noise and the noise source (or take measures to prevent noise interference), and reset the product (or turn off and then turn back on the power supply).</li> <li>(2) Supply power in the range 12 to 24 VDC <math>\pm 10\%</math>.</li> </ol>
		Applied flow is higher than the upper limit (HHH)	<ol style="list-style-type: none"> <li>(1) Check if the flow exceeds the upper limit of the set flow range.</li> <li>(2) Check if foreign matter has entered the piping.</li> </ol>	<ol style="list-style-type: none"> <li>(1) Reset applied flow to a level within the set flow range.</li> <li>(2) Take measures to prevent foreign matter from entering the piping.</li> </ol>
		Applied flow is lower than the lower limit (LLL)	<ol style="list-style-type: none"> <li>(1) Check if the flow exceeds the lower limit of the set flow range.</li> <li>(2) Check if foreign matter has entered the piping.</li> </ol>	<ol style="list-style-type: none"> <li>(1) Reset applied flow to a level within the set flow range.</li> <li>(2) Take measures to prevent foreign matter from entering the piping.</li> </ol>
		Product failure		Replace the product.
7	The display is unstable.	Incorrect power supply	Check if the power supply voltage is in the range 12 to 24 VDC $\pm 10\%$ .	Supply power in the range 12 to 24 VDC $\pm 10\%$ .
		Incorrect wiring	Check the power supply wiring. Check if the brown and blue wires are connected to DC(+) and DC(-) respectively, and if the wiring is secure.	Check and correct the wiring.
		Factory line pressure is not stable	Check if the factory line flow is stable.	Improve the display stability by setting the delay time or digital filter.



Problem No.	Problem	Possible cause	Investigation method	Countermeasures
8	Applied voltage does not match with the displayed pressure value.	Incorrect flow range setting	Check the flow range setting. Check if the connected flow sensor and the set flow range are correct.	Select the correct flow range.
9	<ul style="list-style-type: none"> <li>•The display turns OFF.</li> <li>•Part of the display is missing.</li> </ul>	Incorrect power supply	Check if the power supply voltage is in the range 12 to 24 VDC $\pm$ 10%.	Supply power in the range 12 to 24 VDC $\pm$ 10%.
		Incorrect wiring	Check the power supply wiring. Check if the brown and blue wires are connected to DC(+) and DC(-) respectively, and if the wiring is secure.	Check and correct the wiring.
		Power saving mode	Check if power saving mode is selected.	Select the power saving mode again.
		Product failure		Replace the product.
10	Display flashes.	Incorrect wiring	(1) Check the power supply wiring. (2) Check if there is bending stress applied to any part of the lead wire.	(1) Check and correct the wiring. (2) Correct the wiring (bend radius and stress).
		Display flashes 999.999	Accumulated flow rate has exceeded the upper limit of the display.	Reset the accumulated flow.
11	Flow rate of the connected flow sensor and flow display is inconsistent.	Variation within the display accuracy range	Check if the variation is within the display accuracy range.	If the display accuracy is within the range, set one of the displays to OFF mode (power saving mode).
		Product failure		Replace the product.
12	The flow rate display accuracy does not meet the specifications.	Warming up inadequate	Check if the product satisfies the specified accuracy 10 minutes after supplying power.	After energizing, the display and output can drift. If using the product to detect very small flow differences, warm up the product for 10 to 15 minutes before use.
		Product failure		Replace the product.



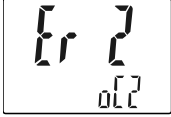

Problem No.	Problem	Possible cause	Investigation method	Countermeasures
13	Display measurement units cannot be changed.	Model selection (the model selected does not have the units selection function)	Check if the product number printed on the product indicates a type with units selection function.	Units selection function is not available for the fixed SI units type. *: The units selection function is not for use in Japan *: Fixed to SI units: L/min
		Product failure		Replace the product.
14	Buttons do not operate.	Key-lock mode is activated	Check if the key-lock function is turned on.	Check the key-lock function.
		Product failure		Replace the product.
15	The operation is unstable. (chattering)	Effect of line pressure fluctuation because hysteresis is too narrow or delay time of the switch is too short	(1) Check the set pressure values (hysteresis). (2) Check the delay time and digital filter set values.	(1) Adjust the set flow value. (2) Change the response time setting.
		Incorrect wiring/broken lead wire	(1) Check the power supply wiring. (2) Check if there is bending stress applied to any part of the lead wire. (bending radius, tensile force to the lead wire)	(1) Check and correct the wiring. (2) Correct the wiring. (Reduce the tensile force or increase the bending radius.)
		Product failure		Replace the product.
16	Not able to copy	Specifications are not consistent with the copy source.	Check if the input specification, output specification and unit specifications are consistent with the copy source monitor.	Use a product for which the specifications are the same as the copy source's specification.
		Product failure		Replace the product.

○Error indication function

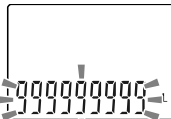
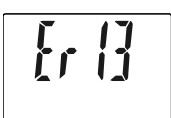
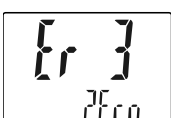
This function is to display error location and content when a problem or error has occurred.

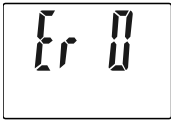
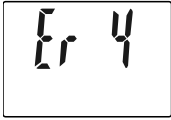
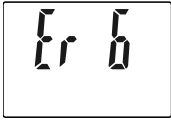
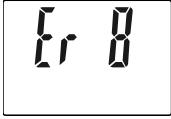
Error	Error displayed	Description	Measures
Over current error	 	The switch output load current is 80 mA or more.	Turn the power off and remove the cause of the over current. Then supply the power again.
Flow error		Flow exceeding the upper limit of the set flow range is applied.	Reset applied flow to a level within the set flow range.
		Flow exceeding the lower limit of the set flow range is applied.	
Accumulated flow error		Accumulated flow rate has exceeded the upper limit of the display.	Reset the accumulated flow.
COPY receiving error		Communication is not complete.	After checking the wiring, retry copying.
Zero clear error		During zero clear operation, pressure greater than $\pm 5\%$ F.S. is applied. (The mode is returned to measurement mode automatically 1 second later.)	Retry the zero clear operation without applying fluid.

Error	Error displayed	Description	Measures
System error	    	Displayed if an internal data error has occurred.	Turn the power off and on again. If the failure cannot be solved, contact SMC.

If the error cannot be reset after the above measures are taken, or errors other than above are displayed, please contact SMC.

# Specifications

Model		PFGM3#2								
Applicable SMC Flow Switch	Model	PF2M701	PF2M702	PF2M705	PF2M710	PF2M725	PF2M750	PF2M711	PF2M721	
	Rated flow range*1	0.01 to 1 L/min	0.02 to 2 L/min	0.05 to 5 L/min	0.1 to 10 L/min	0.3 to 25 L/min	0.5 to 50 L/min	1 to 100 L/min	2 to 200 L/min	
Flow	Set flow rate range	Instantaneous flow	-0.05 to 1.05 L/min	-0.1 to 2.1 L/min	-0.25 to 5.25 L/min	-0.5 to 10.5 L/min	-1.3 to 26.3 L/min	-2.5 to 52.5 L/min	-5 to 105 L/min	-10 to 210 L/min
		Accumulated flow	0.00 to 9999999.99 L		0.0 to 99999999.9 L		0 to 999999999 L			
	Min. setting unit	Instantaneous flow	0.001 L/min	0.01 L/min			0.1 L/min		1 L/min	
		Accumulated flow	0.01 L		0.1 L		1 L			
	Accumulated volume per pulse (Pulse width = 50 msec.)		0.01 L			0.1 L		1 L		
	Accumulated value hold*3		Every 2 or 5 minutes, The stored accumulated flow is held even when the power supply is OFF.							
Electrical	Power supply voltage	12 to 24 VDC±10%								
	Current consumption	25 mA or less								
	Protection	Polarity protection								
Accuracy	Display accuracy	±0.5%F.S. Min. display unit (at ambient temperature 25 °C constant temperature)								
	Analogue output accuracy	±0.5%F.S. (at ambient temperature 25 °C constant temperature)								
	Repeatability	±0.1%F.S. Min. display unit								
	Temperature characteristics	±0.5%F.S. (at ambient temperature 0 to 50 °C, 25 °C standard)								
Switch output	Output type	Select from NPN or PNP open collector output.								
	Output mode	Hysteresis mode, Window comparator mode, Accumulated output mode or Accumulated pulse output mode, Error output mode or switch output OFF mode.								
	Switch operation	Normal output or Reversed output								
	Max. load current	80 mA								
	Max. applied voltage (Only NPN)	30 VDC								
	Internal voltage drop (Residual voltage)	NPN output: 1.0 V or less (at 80 mA), PNP output: 1.5 V or less (at 80 mA)								
	Response time*2	3 ms or less								
	Delay time*2	Select from 0, 0.05 to 0.10 sec. (increment of 0.01 sec.), 0.1 to 1.0 sec. (increment of 0.1 sec.), 1 to 10 sec. (increment of 1 sec.), 20 sec., 30 sec., 40 sec., 50 sec. and 60 sec.								
	Hysteresis*4	Variable								
	Protection	Short circuit protection								
Analogue output*5	Output type	Voltage input: 1 to 5 VDC, 0 to 10 VDC (only when the power supply voltage is 24 VDC)*6 Current input: 4 to 20 mA (0 L/min to max. value of the rated flow)								
	Impedance	Voltage output	Output impedance approx.: 1 kΩ							
		Current output	Max. load impedance: 300 Ω at 12 VDC, 600 Ω at 24 VDC							
	Response time*2	50 ms or less								

Model		PFGM3#2										
External input *7	External input specification	Input voltage: 0.4 V or less (reed or solid state type), Input time: 30 msec. or longer										
	Input mode	Accumulated flow external reset or peak/bottom hold value										
Sensor input	Input type	Voltage input: 1 to 5 VDC (Input impedance: 1 M $\Omega$ ) Current input: 4 to 20 mA (Input impedance: 51 $\Omega$ ) (0 L/min to max. value of the rated flow)										
	Connection method	Connector (e-con)										
	Protection	Over voltage protection (up to 26.4 V)										
Display	Display mode	Select from Instantaneous flow or Accumulated flow.										
	Unit *8	Instantaneous flow	L/min, cfm (ft <sup>3</sup> /min)									
		Accumulated flow	L, ft <sup>3</sup> , L $\times$ 10 <sup>6</sup> , ft <sup>3</sup> x 10 <sup>6</sup>									
	Displayable range	Instantaneous flow	-0.05 to 1.05 L/min	-0.1 to 2.1 L/min	-0.25 to 5.25 L/min	-0.5 to 10.5 L/min	-1.3 to 26.3 L/min	-2.5 to 52.5 L/min	-5 to 105 L/min	-10 to 210 L/min		
		Accumulated flow *10	0.00 to 9999999.99		0.0 to 99999999.9		0 to 999999999					
	Min. setting unit	Instantaneous flow	0.001 L/min	0.01 L/min			0.1 L/min			1 L/min		
		Accumulated flow	0.01 L		0.1 L		1 L					
	Display type	LCD										
	Number of displays	3-screen display (Main display, sub display)										
	Display color	1) Main display: Red/Green 2) Sub display: Orange										
Number of display digits	1) Main display: 5 digit (7-segments) 2) Sub display: 9 digit (7-segments)											
Indicator LED	LED is ON when switch output is ON (OUT1/OUT2: Orange)											
Digital filter *9	Select from 0, 0.05 to 0.10 sec. (increment of 0.01 sec.), 0.1 to 1.0 sec. (increment of 0.1 sec.), 1 to 10 sec. (increment of 1 sec.), 20 sec., 30 sec.											
Environmental	Enclosure rating	IP40										
	Withstand voltage	1000 VAC, for 1 minute between live parts and case										
	Insulation resistance	50 M $\Omega$ or more between live parts and case (with 500 VDC megger)										
	Operating temperature range	Operation: 0 to 50 $^{\circ}$ C, Storage: -10 to 60 $^{\circ}$ C (No condensation or freezing)										
	Operating humidity range	Operation, Storage: 35 to 85%RH (no condensation or freezing)										
Standards	CE/UKCA marked, UL(CSA)											
Weight	Body	25 g (without lead wire)										
	Lead wire with connector	+39 g										

\*1: Rated flow range of the applicable flow switch.

\*2: Value without digital filter (at 0 ms).

\*3: When using the accumulated value hold function, calculate the product life from the operating conditions, and use the product within its life.  
The maximum access limit of the memory device is 1.5 million cycles. If the product is operated 24 hours per day, the product life will be as follows.

•5 min. cycle: 5 min. x 1.5million times = 7.5 million min. = 14.3 years/2 min. cycle: 2min. x 1.5 million times = 3 million min. = 5.7 years

If the Accumulated flow external reset is repeatedly used, the product life will be shorter than the calculated life.

\*4: If the applied voltage fluctuates around the set value, the hysteresis width must be greater than the fluctuation width. Otherwise, chattering will occur.

\*5: This function is available only for models with analogue output.

\*6: When selecting 0 to 10 V, refer to the analogue output graph for the allowable load current.

\*7: This function is available only for models with external input.

\*8: Setting is possible only for models with the units selection function.

\*9: The response time indicates when the set value is 90% in relation to the step input.

\*10: Accumulated value is displayed in up to 9 digits.

\*11: Any products with tiny scratches, smears, or variations in the display colour or brightness, which does not affect the performance of the product, are verified as conforming products.

## ■ Characteristics data

### ● Flow rate/Analogue output

	A	B *2	C
Voltage output (1 to 5 V)	1 V	1.04 V	5 V
Current output (4 to 20 mA)	4 mA	4.16 mA	20 mA

	E	F	G
Voltage output (0 to 10 V) *1	0 V	0.10 V	10 V

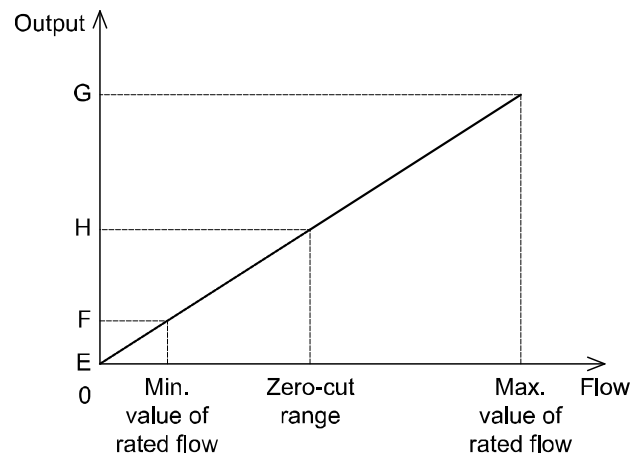
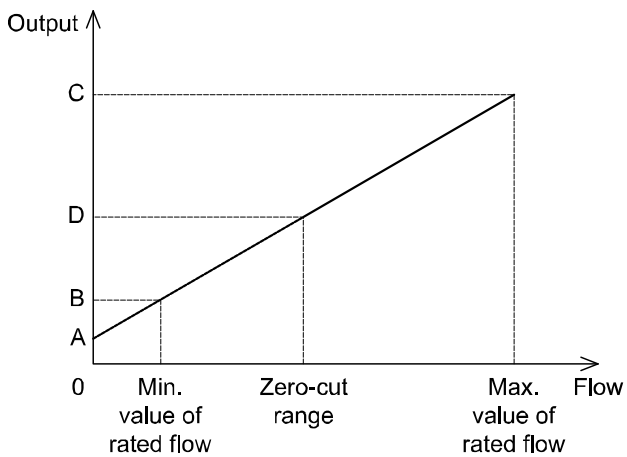

\*1: The analogue output current from the connected equipment should be 20  $\mu$ A or less when selecting 0 to 10 V.

When more than 20  $\mu$ A current flows, it is possible that the accuracy will not be satisfied below 0.5 V.

\*2: D or H changes based on the setting of the zero cut-off function.

When the zero cut-off function is set to "0", the display starts from 0 L/min. In conditions other than horizontal installation and 0.35 MPa supply pressure, the output may not be 0 L/min.

## ■Dimensions

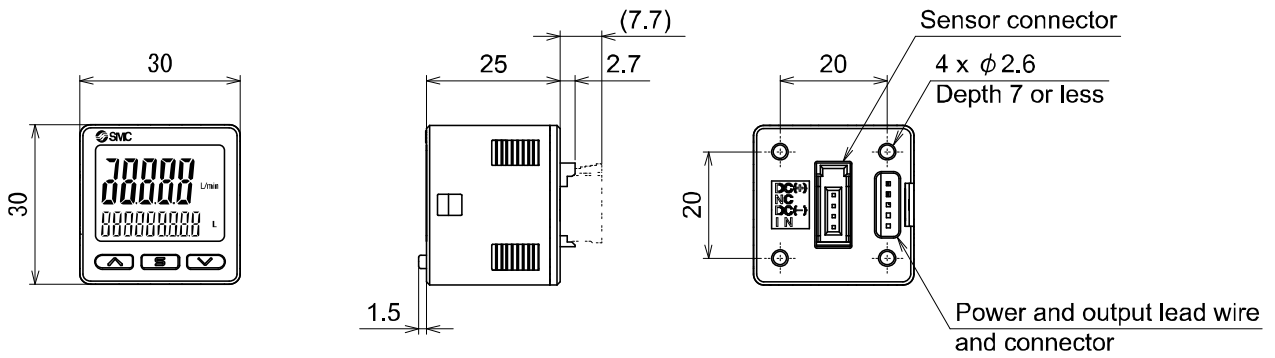

○Bracket A (Part No: ZS-46-A1)

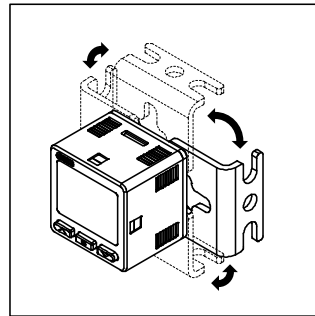
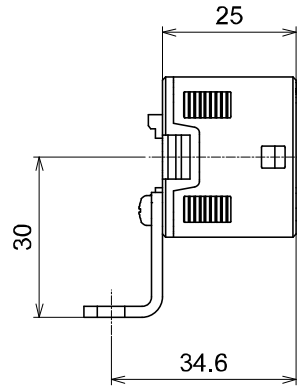
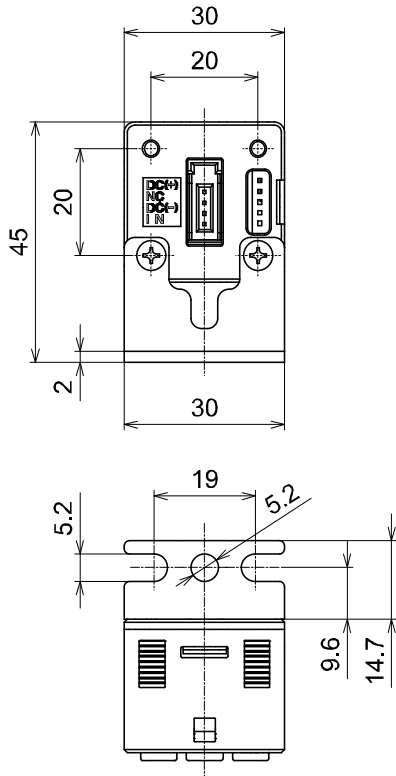

\*Bracket can be mounted on 4 sides.

○Bracket B (Part No: ZS-46-A2)

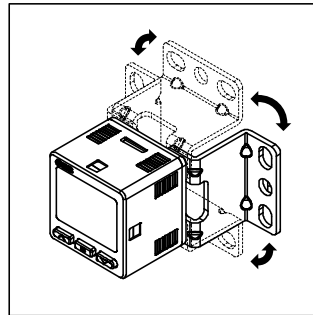
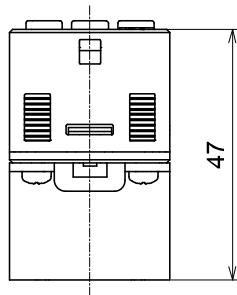

\*Bracket can be mounted on 4 sides.

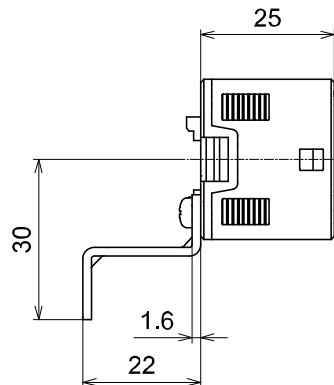
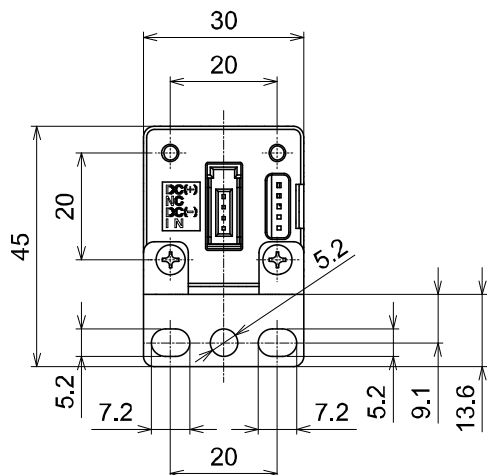



○Panel mount adapter (Part No: ZS-46-B)

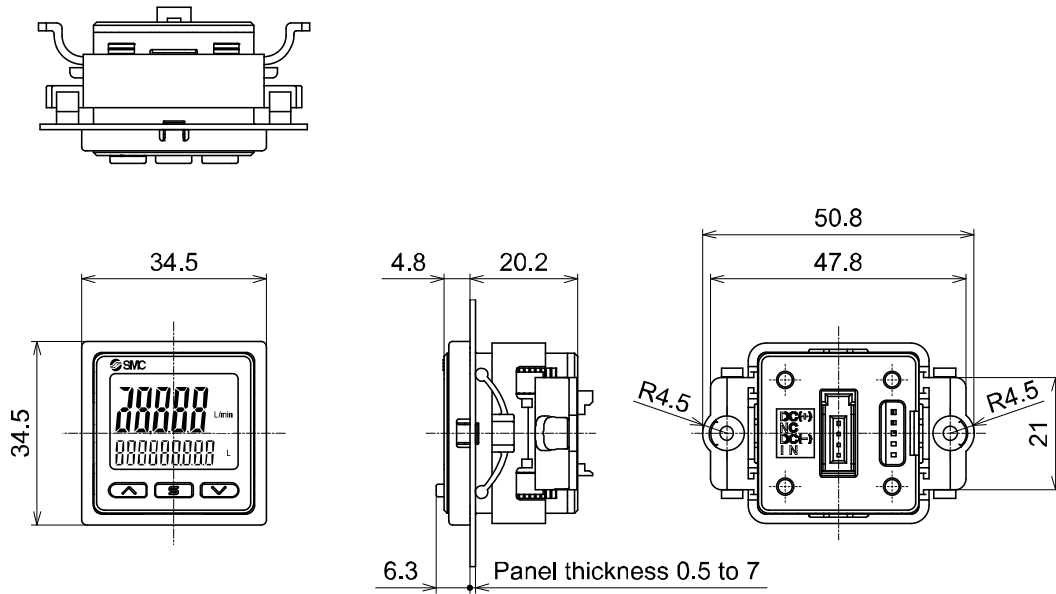

○Panel mount adapter + Front protective cover (Part No: ZS-46-D)

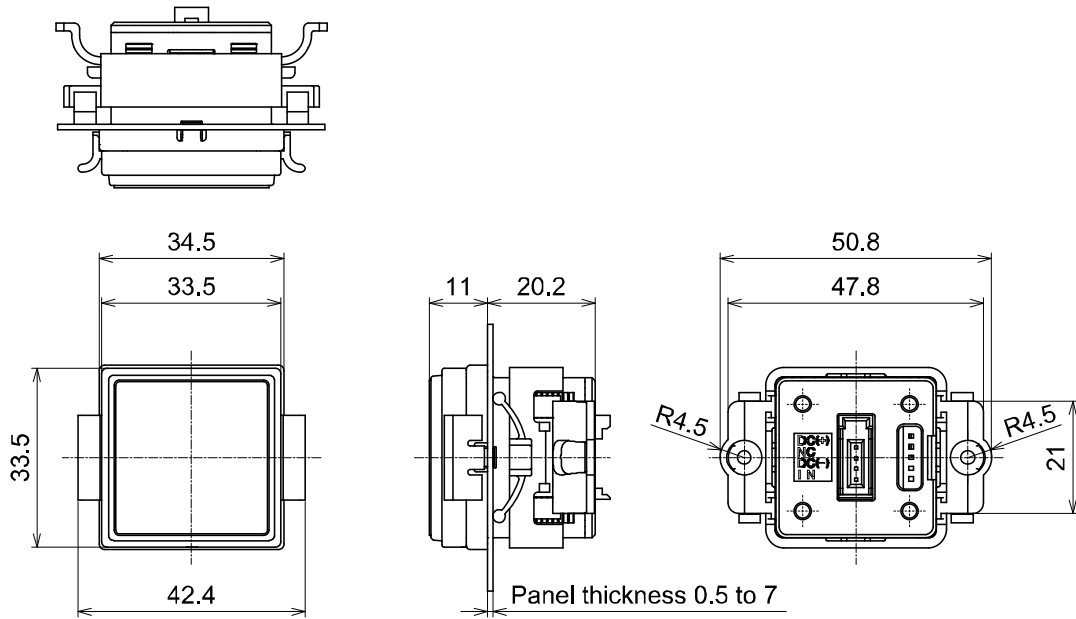

○Lead wire with connector (Part No: ZS-46-5L)

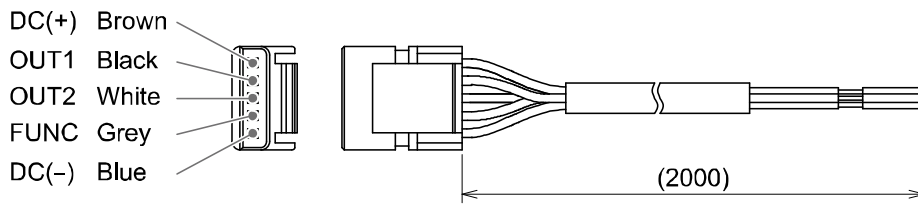

Conductor area		0.15 mm <sup>2</sup> (AWG26)
Insulator	Outside diameter	1.0 mm
	Colour	Brown, Blue, Black, white, grey (5 core)
Sheath	Finished outside diameter	φ3.5

○Sensor connector (Part No: ZS-28-C-1)

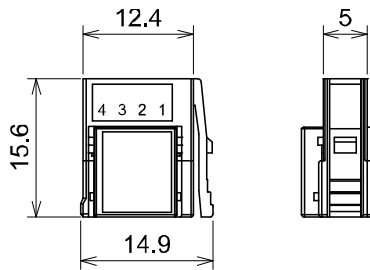

PIN No.	Description
1	DC(+)
2	N.C.
3	DC(-)
4	IN *

\*: 1 to 5 V or 4 to 20 mA

○ Panel cut-out dimensions

Mounting individually

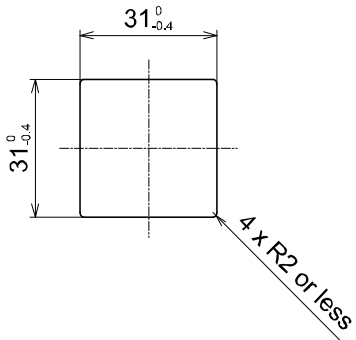

More than 2 pcs. (n pcs.) Close mounting

<Horizontal>

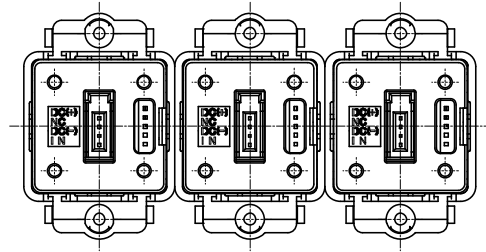
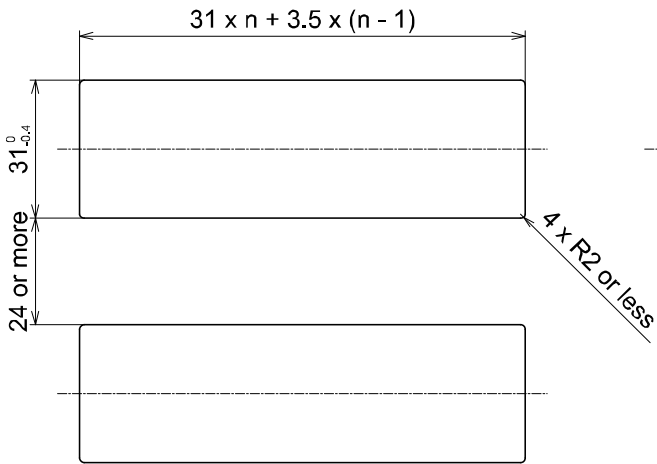

<Vertical>

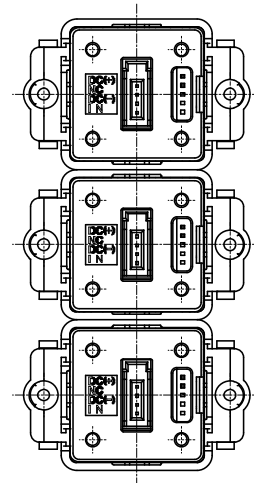
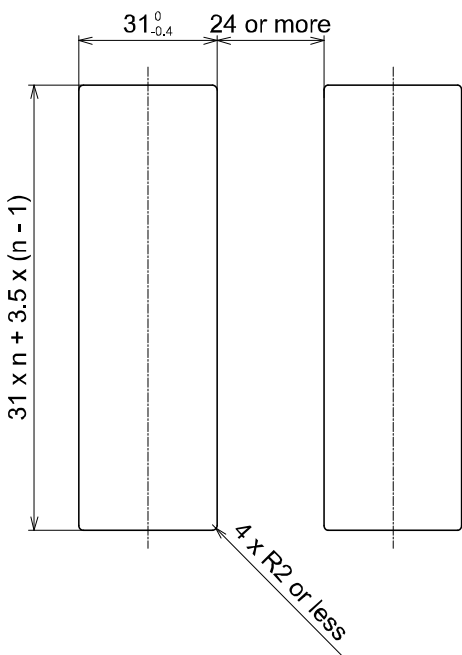

#### Revision history

- 1: Contents revised in several places. [May 2024]
- 2: Contents revised in several places.  
[December 2024]

## SMC Corporation

Tel: + 81 3 5207 8249 Fax: +81 3 5298 5362  
URL <https://www.smcworld.com>

---

Note: Specifications are subject to change without prior notice and any obligation on the part of the manufacturer.  
© SMC Corporation All Rights Reserved

