



Operation Manual

PRODUCT NAME

Digital Flow Monitor

MODEL / Series / Product Number

PF3#0

SMC Corporation

Table of Contents

Safety Instructions	3
Model Indication and How to Order	9
Summary of Product parts	10
Definition and terminology	11
Mounting and Installation	13
Installation	13
Wiring	15
Flow Setting	21
Outline of Settings	22
Initial Setting	23
3 Step Setting Mode	27
Simple Setting Mode	29
Function Selection Mode	30
Function selection mode	30
Default setting	30
F0 Flow range, display units and switch output selection	32
F 1 Setting of OUT1	36
F 2 Setting of OUT2	41
F 3 Digital filter setting	44
F 5 FUNC terminal function setting	45
F10 Sub display setting	48
F14 Display with zero cut-off setting	50
F30 Accumulated value hold setting	52
F80 Power saving mode	53
F81 Security code	54
F90 Setting of all functions	56
F96 Sensor input/External input signal status display	58
F97 Copy setting	59
F98 Output check	62
F99 Reset to default settings	64
Other Settings	65
Maintenance	69
Forgotten the security code	69
Troubleshooting	70
Specifications	78
Characteristics data	80
Dimensions	81



Safety Instructions

These safety instructions are intended to prevent hazardous situations and/or equipment damage. These instructions indicate the level of potential hazard with the labels of “**Caution**,” “**Warning**” or “**Danger**.” They are all important notes for safety and must be followed in addition to International Standards (ISO/IEC)^{*)}, and other safety regulations.

*1) ISO 4414: Pneumatic fluid power - General rules and safety requirements for systems and their components
ISO 4413: Hydraulic fluid power - General rules and safety requirements for systems and their components
IEC 60204-1: Safety of machinery - Electrical equipment of machines - Part 1: General requirements
ISO 10218-1: Robots and robotic devices - Safety requirements for industrial robots - Part 1: Robots
etc.



Danger

Danger indicates a hazard with a high level of risk which, if not avoided, will result in death or serious injury.



Warning

Warning indicates a hazard with a medium level of risk which, if not avoided, could result in death or serious injury.



Caution

Caution indicates a hazard with a low level of risk which, if not avoided, could result in minor or moderate injury.



Warning

1. The compatibility of the product is the responsibility of the person who designs the equipment or decides its specifications.

Since the product specified here is used under various operating conditions, its compatibility with specific equipment must be decided by the person who designs the equipment or decides its specifications based on necessary analysis and test results. The expected performance and safety assurance of the equipment will be the responsibility of the person who has determined its compatibility with the product. This person should also continuously review all specifications of the product referring to its latest catalog information, with a view to giving due consideration to any possibility of equipment failure when configuring the equipment.

2. Only personnel with appropriate training should operate machinery and equipment.

The product specified here may become unsafe if handled incorrectly. The assembly, operation and maintenance of machines or equipment including our products must be performed by an operator who is appropriately trained and experienced.

3. Do not service or attempt to remove product and machinery/equipment until safety is confirmed.

1. The inspection and maintenance of machinery/equipment should only be performed after measures to prevent falling or runaway of the driven objects have been confirmed.
2. When the product is to be removed, confirm that the safety measures as mentioned above are implemented and the power from any appropriate source is cut, and read and understand the specific product precautions of all relevant products carefully.
3. Before machinery/equipment is restarted, take measures to prevent unexpected operation and malfunction.

4. Our products cannot be used beyond their specifications. Our products are not developed, designed, and manufactured to be used under the following conditions or environments. Use under such conditions or environments is not covered.

1. Conditions and environments outside of the given specifications, or use outdoors or in a place exposed to direct sunlight.
2. Use for nuclear power, railways, aviation, space equipment, ships, vehicles, military application, equipment affecting human life, body, and property, fuel equipment, entertainment equipment, emergency shut-off circuits, press clutches, brake circuits, safety equipment, etc., and use for applications that do not conform to standard specifications such as catalogs and operation manuals.
3. Use for interlock circuits, except for use with double interlock such as installing a mechanical protection function in case of failure. Please periodically inspect the product to confirm that the product is operating properly.



Safety Instructions

Caution

We develop, design, and manufacture our products to be used for automatic control equipment, and provide them for peaceful use in manufacturing industries.

Use in non-manufacturing industries is not covered.

Products we manufacture and sell cannot be used for the purpose of transactions or certification specified in the Measurement Act.

The new Measurement Act prohibits use of any unit other than SI units in Japan.

Limited warranty and Disclaimer/Compliance Requirements

The product used is subject to the following “Limited warranty and Disclaimer” and “Compliance Requirements”. Read and accept them before using the product.

Limited warranty and Disclaimer

1. The warranty period of the product is 1 year in service or 1.5 years after the product is delivered, whichever is first.*2)
Also, the product may have specified durability, running distance or replacement parts. Please consult your nearest sales branch.
2. For any failure or damage reported within the warranty period which is clearly our responsibility, a replacement product or necessary parts will be provided.
This limited warranty applies only to our product independently, and not to any other damage incurred due to the failure of the product.
3. Prior to using SMC products, please read and understand the warranty terms and disclaimers noted in the specified catalog for the particular products.

***2) Vacuum pads are excluded from this 1 year warranty.**

A vacuum pad is a consumable part, so it is warranted for a year after it is delivered.

Also, even within the warranty period, the wear of a product due to the use of the vacuum pad or failure due to the deterioration of rubber material are not covered by the limited warranty

Compliance Requirements

1. The use of SMC products with production equipment for the manufacture of weapons of mass destruction (WMD) or any other weapon is strictly prohibited.
2. The exports of SMC products or technology from one country to another are governed by the relevant security laws and regulations of the countries involved in the transaction. Prior to the shipment of a SMC product to another country, assure that all local rules governing that export are known and followed.

Operator

- ◆ This operation manual is intended for those who have knowledge of machinery using pneumatic equipment, and have sufficient knowledge of assembly, operation and maintenance of such equipment. Only those persons are allowed to perform assembly, operation and maintenance.
- ◆ Read and understand this operation manual carefully before assembling, operating or providing maintenance to the product.

■ Safety Instructions

Warning

- Do not disassemble, modify (including changing the printed circuit board) or repair.
An injury or failure can result.
- Do not operate the product outside of the specifications.
Do not use for flammable or harmful fluids.
Fire, malfunction, or damage to the product can result.
Verify the specifications before use.
- Do not operate in an atmosphere containing flammable or explosive gases.
Fire or an explosion can result.
This product is not designed to be explosion proof.
- Do not use the product in a place where static electricity is a problem.
Otherwise it can cause failure or malfunction of the system.
- If using the product in an interlocking circuit:
 - Provide a double interlocking system, for example a mechanical system
 - Check the product regularly for proper operationOtherwise malfunction can result, causing an accident.
- The following instructions must be followed during maintenance:
 - Turn off the power supply
 - Stop the air supply, exhaust the residual pressure and verify that the air is released before performing maintenanceOtherwise an injury can result.

Caution

■ Do not touch the terminals and connectors while the power is on.
Otherwise electric shock, malfunction or damage to the product can result.

■ After maintenance is complete, perform appropriate functional inspections and leak tests.
Stop operation if the equipment does not function properly or there is a leakage of fluid.
When leakage occurs from parts other than the piping, the product might be faulty.
Disconnect the power supply and stop the fluid supply.
Do not apply fluid under leaking conditions.
Safety cannot be assured in the case of unexpected malfunction.

■ **NOTE**

- Follow the instructions given below when designing, selecting and handling the product.
 - The instructions on design and selection (installation, wiring, environment, adjustment, operation, maintenance, etc.) described below must also be followed.
 - *Product specifications
 - Use the specified voltage.
Otherwise failure or malfunction can result.
 - Use the specified flow sensor.
Otherwise the product may be broken and it will not be able to perform proper measurement.
 - Do not exceed the specified maximum allowable load.
Otherwise it can cause damage or shorten the lifetime of the product.
 - Design the product to prevent reverse current when the circuit is opened or the product is forced to operate for operational check.
Reverse current can cause malfunction or damage to the product.
 - Input data to the product is not deleted, even if the power supply is cut off.
(Writing time: 1,500,000 cycles)
 - Reserve a space for maintenance.
Allow sufficient space for maintenance when designing the system.

●Product handling

*Installation

- Tighten to the specified tightening torque.

If the tightening torque is exceeded the mounting screws and brackets may be broken.

If the tightening torque is insufficient, the product can be displaced and loosen the mounting screws.

- Be sure to ground terminal FG when using a commercially available switch-mode power supply.
- Do not drop, hit or apply shock to the product.

Otherwise damage to the internal parts can result, causing malfunction.

- Do not pull the lead wire forcefully, not lift the product by pulling the lead wire.
(Tensile force 50 N or less)

Hold the body when handling to avoid the damage of the product which lead to cause the failure and malfunction.

*Wiring

- Do not pull the lead wires. In particular, do not lift or carry the product by holding the cables once they are connected to the product.

Otherwise damage to the internal parts can result, causing malfunction or to be off the connector.

- Avoid repeatedly bending or stretching the lead wire, or placing heavy load on them.

If the lead wire can move, fix it near the body of the product.

The recommended bend radius of the lead wire is 6 times the outside diameter of the sheath, or 33 times the outside diameter of the insulation material, whichever is larger.

Replace the damaged lead wire with a new one.

- Wire correctly.

Incorrect wiring can break the product.

- Do not perform wiring while the power is on.

Otherwise damage to the internal parts can result, causing malfunction.

- Do not route wires and cables together with power or high voltage cables.

Otherwise the product can malfunction due to interference of noise and surge voltage from power and high voltage cables to the signal line. Route the wires (piping) of the product separately from power or high voltage cables.

- Confirm proper insulation of wiring.

Poor insulation (interference from another circuit, poor insulation between terminals, etc.) can lead to excess voltage or current being applied to the product, causing damage.

- Design the system to prevent reverse current when the product is forced to operate for operational check.

Depending on the circuit used, insulation may not be maintained when operation is forced, allowing reverse current to flow, which can cause malfunction and damage the product.

- Keep wiring as short as possible to prevent interference from electromagnetic noise and surge voltage.

Do not use a cable longer than 30 m.

Wire the DC(-) line(blue) as close as possible to the power supply.

*Environment

- Do not use the product in area that is exposed to corrosive gases, chemicals, sea water, water or steam.
Otherwise failure or malfunction can result.

- Do not use the product in an environment where the product is constantly exposed to water or oil splashes.

If the product is to be used in an environment containing oils or chemicals such as coolant or cleaning solvent, it may be adversely affected (damage, malfunction, or hardening of the lead wires).

- Do not use in an area where surges are generated.

If there is equipment which generates a large amount of surge (solenoid type lifter, high frequency induction furnace, motor, etc.) close to the product, this may cause deterioration or breakage of the internal circuit of the product. Avoid sources of surge generation and crossed lines.

- Do not use a load which generates surge voltage.
When a surge-generating load such as a relay or solenoid is driven directly, use a load with a built-in surge suppressor.
- The product is CE/UKCA marked, but not immune to lightning strikes. Take measures against lightning strikes in the system.
- Mount the product in a place that is not exposed to vibration or impact.
Otherwise failure or malfunction can result.
- Prevent foreign matter such as remnant of wires from entering the product.
Take proper measures for the remnant not to enter the product in order to prevent failure or malfunction.
- Do not use the product in an environment that is exposed to temperature cycle.
Heat cycles other than ordinary changes in temperature can adversely affect the inside of the product.
- Do not expose the product to direct sunlight.
If using in a location directly exposed to sunlight, shade the product from the sunlight.
Otherwise failure or malfunction can result.
- Keep within the specified ambient temperature range.
The ambient temperature range is 0 to 50 °C. Operation at low temperature (5 °C or less) may cause damage or operation failure due to frozen moisture in the air.
Protection against freezing is necessary.
Avoid sudden temperature change even within specified temperature.
- Do not operate close to a heat source, or in a location exposed to radiant heat.
Otherwise malfunction can result.

*Adjustment and Operation

- Turn the power on after connecting a load.
Otherwise it can cause excess current causing instantaneous breakage of the product.
- Do not short-circuit the load.
Although error is displayed when the load at the output part has a short circuit, generated over current may lead to the damage of the product.
- Do not press the setting buttons with a sharp pointed object.
It may damage the setting buttons.
- If using the product to detect very small pressure rates, warm up the product for 10 to 15 minutes first.
There will be a drift on the display or the analogue output of approximate $\pm 1\%$ immediately after the power supply is turned on, within 10 minutes.
- Perform settings suitable for the operating conditions.
Incorrect setting can cause operation failure.
For details of each setting, refer to page 21 to 68 of this manual.
- Do not touch the LCD during operation.
The display can vary due to static electricity.

*Maintenance

- Turn OFF the power supply before maintenance.
There is a risk of unexpected malfunction.
- Perform regular maintenance and inspections.
There is a risk of unexpected malfunction.
- Do not use solvents such as benzene, thinner etc. to clean the product.
They could damage the surface of the body and erase the markings on the body.
Use a soft cloth to remove stains. For heavy stains, use a cloth soaked with diluted neutral detergent and fully squeezed, then wipe up the stains again with a dry cloth.

Model Indication and How to Order

PFG3 **0** 0 - **RT** - **M** - **L** **A1** **C** **Y**

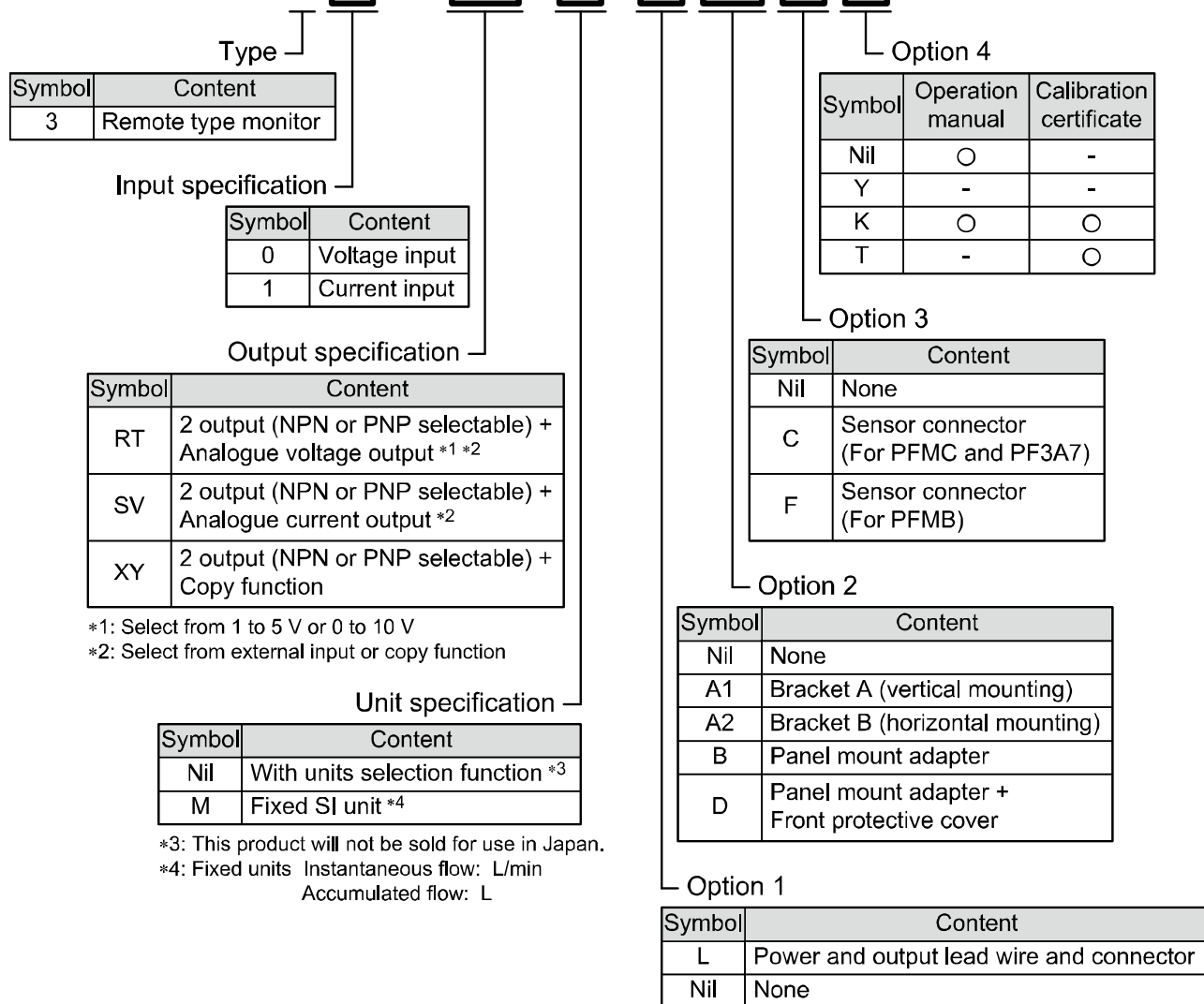

○Accessories/Part numbers

If an option is required independently, order with the following part numbers.

Items	Part No.	Remarks
Sensor connector (For PFMB)	ZS-28-C-1	
Sensor connector (For PFMC and PF3A7)	ZS-28-CA-4	
Bracket A	ZS-46-A1	Self tapping screws: Nominal size 3 x 8L (2 pcs)
Bracket B	ZS-46-A2	Self tapping screws: Nominal size 3 x 8L (2 pcs)
Panel mount adapter	ZS-46-B	
Panel mount adapter + Front protective cover	ZS-46-D	
Lead wire with connector	ZS-46-5L	5 cores, 2 m
Front protective cover	ZS-27-01	

Summary of Product parts

Names of individual parts

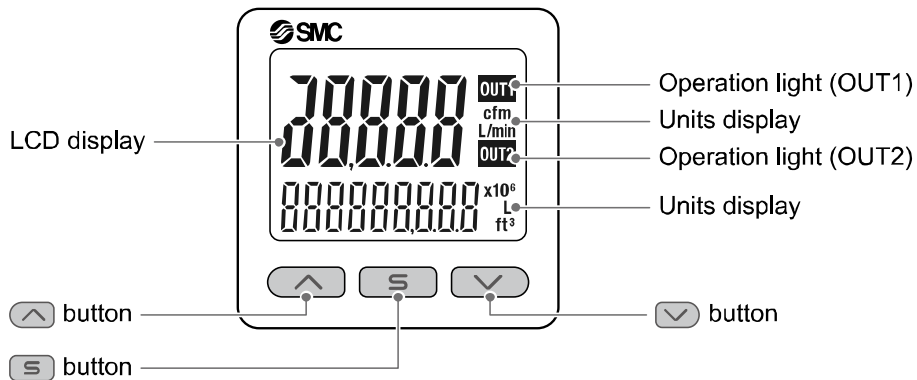

Operation light: Displays the switch operating condition.

LCD display: Displays the current status of flow, setting mode, selected display units and error code.

4 types of display can be selected for the main display: Single colour of constant red or green; or switching from red to green or green to red corresponding to the output.
The indication for the sub display is orange.

^ button: Increases mode and ON/OFF set values.

∨ button: Decreases mode and ON/OFF set values.

S button: Press this button to change mode and to confirm settings.

Unit display: Indicates the units currently selected.

■ Definition and terminology

	Term	Definition
A	Accumulated flow	The total amount of fluid that has passed through the device. If an instantaneous flow of 1,000 L/min lasts for 5 minutes, the accumulated flow will be $5 \times 1,000 = 5,000$ L.
	Accumulated pulse output	A type of output where a pulse is generated every time a predefined accumulated flow passes. It is possible to calculate the total accumulated flow by counting the pulses.
	Accumulated-value hold time	A function to store the cumulative flow value in the product's internal memory at set time intervals. The memory data is read when power is supplied. Accumulation of data begins with the value read at the moment power is supplied. The time interval for storing to memory can be selected from 2 or 5 minutes.
	Analogue output	An Output value proportional to the flow rate. When the analogue output is in the range of 1 to 5 V, it will vary between 1 to 5 V according to the flow rate change. The same occurs for analogue output of 0 to 10 V and 4 to 20 mA.
B	Bottom value display (mode)	The min. flow recorded from when the power was supplied to the present time.
C	Chattering	The problem of the switch output turning ON and OFF repeatedly around the set value at high frequency due to the effect of pulsation.
	Copy function	Function to copy the set values of the copy source monitor to a copy destination monitor.
D	Delay time	The setting time from when the connected flow sensor signal reaches the set value, to when the ON-OFF output actually operates. Adjusting the delay time can prevent the output from chattering.
	Digit (smallest settable increment)	How precisely the pressure can be displayed or set. When 1 digit = 1 L/min, the value is displayed in increments of 1 L/min, e.g., 1, 2, 3, ..., 99, 100.
	Digital filter	Function to add digital filtering to any fluctuation in the input signal. Smooth the fluctuation of the displayed value for sharp start up or fall of the flow. When the function is used, digital filtering is reflected in the switch output ON/OFF or analogue output. Output chattering or display flicker in measurement mode can be reduced by setting the digital filter. The response time indicates when the set value is 90% in relation to the step input.
	Display accuracy	The max. deviation between the displayed flow rate and the actual flow rate.
	Display colour	Indicates the colour of the digital display. Always green, always red, green (switch OFF) changing to red (switch ON), or red (switch OFF) changing to green (switch ON) are available in window comparator mode.
	Display range	The range of flow that can be displayed.
	Display resolution	Indicates into how many units the rated flow range can be divided. (Example: When the value can be displayed down to 1 L/min for a product with a rated flow range of 1,000 L/min, the resolution is 1/1000).
E	Energy saving mode	Operating mode in which the digital display turns off to reduce power consumption.
	Error display	A code number displayed to identify the error code detected by the self-diagnostic function of the product. Refer to "Error indication function" on page 76 for details of the errors.
	Error output	Switches the switch output to ON/OFF when an error is displayed.
F	F.S. (full span/full scale)	Abbreviation of full span or full scale; the difference between the min. and max. rated flow values. In other words the max. rated fluctuation range of the flow switch. For example, when the rated flow range is 0 to 1000 L/min, $F.S. = 1000 - (0) = 1000$ L/min. (Reference: $1\%F.S. = 1000 \times 0.01 = 10$ L/min)

	Term	Definition
F	Function selection mode	The mode in which setting of functions is performed. It is a separate menu from the display setting. If any function settings need to be changed from the factory default, each setting can be selected with "F*". The setting items are: display colour, display range, display units, operation mode, output type, delay time, digital filter, power saving mode, security code, etc.
H	Hysteresis	The difference between ON and OFF points used to prevent chattering. Hysteresis can be effective in avoiding the effects of pulsation.
	Hysteresis mode	Mode where the switch output will turn ON when the flow is greater than the set value, and will turn OFF when the flow falls below the set value by the amount of hysteresis or more.
I	Insulation resistance	The insulation resistance between the electrical circuit and the case.
K	Key-lock function	Function that prevents changes to the settings (disables button operation).
M	Max. applied voltage	The max. voltage that can be connected to the output of an NPN device.
	Max. load current	The max. current that can flow to the switch output.
	Measurement mode	Operating condition in which pressure is being detected and displayed, and the switch function is working.
	Min. resolution	Refer to "digit".
N	Normal output	One of the switch output types. In hysteresis mode the switch output is turned ON when flow equal to or greater than the switch output set value is detected. In window comparator mode, the switch output is turned ON when flow between the switch output set values (P1L to P1H) is detected.
O	Operation LED	An LED that turns on when the switch output is ON.
	Operation mode	Operation selected from Hysteresis mode/ Window comparator mode/ Accumulated output mode/Accumulated pulse mode/ Error detection mode/ Output OFF mode.
	Output	The operation principle of the switch output. Normal output and reverse output can be selected.
P	Peak value display (mode)	The max. flow rate recorded from when the power was supplied to the present time.
R	Rated flow range	The flow range within which the product will meet all published specifications.
	Repeatability	The repeatability of the display or analogue output value, when the measured flow quantity is repeatedly increased and decreased.
	Resolution	Refer to "Display resolution".
	Reversed output	One of the switch output types. In hysteresis mode the switch output is turned ON when a flow less than or equal to the switch output set value is detected. In window comparator mode, the switch output is turned ON when flow outside of the switch output set values (n1L to n1H) is detected.
	Ripple	A type of chattering.
S	Set point range	The flow range that can be set for the switch output.
	Switch output	Output type that only has 2 possible states, ON or OFF. Sometimes referred to as "ON-OFF output".
U	Units selection function	A function to select the display units other than the international units (SI units) specified in Japanese measurement law. The product for use in Japan is not equipped with this function.
W	Window comparator mode	An operating mode in which the switch output is turned on and off depending on whether the flow is inside or outside a range of two set values.
	Withstand voltage	A measure of the product's resistance to a voltage applied between the electrical circuit and case. The product may be damaged if a voltage above this value is applied. (The withstand voltage is not the supply voltage used to power the product).

Mounting and Installation

■ Installation

○ Mounting with bracket

- Mount the bracket to the body with mounting screws (Self tapping screws: Nominal size 3 x 8L (2 pcs.)), then set the body to the specified position.

*: Tighten the bracket mounting screws to a torque of $0.5 \pm 0.05 \text{ N}\cdot\text{m}$.
Self tapping screws are used, and should not be re-used several times.

- Bracket A (Part No.: ZS-46-A1)

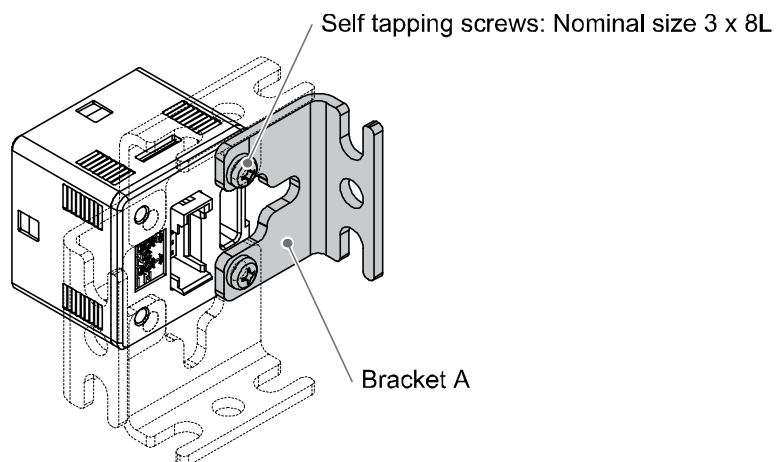

- Bracket B (Part No.: ZS-46-A2)

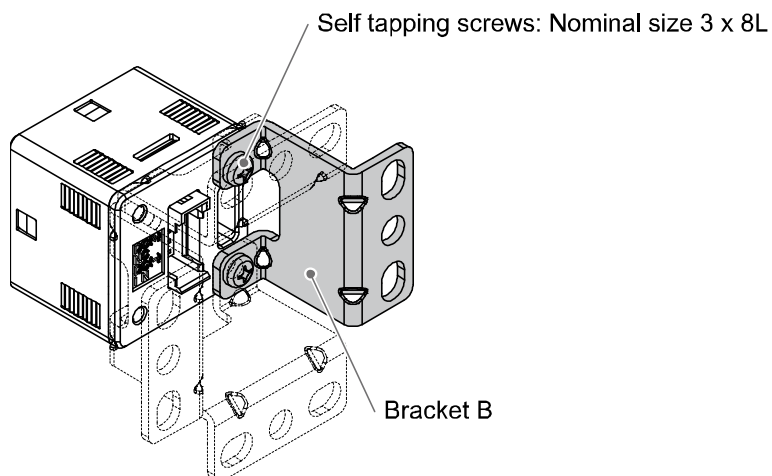

○ Mounting with panel mount adapter

● Mount part (a) to the front of the body and fix it. Then insert the body with (a) into the panel until (a) comes into contact with the panel front surface. Next, mount part (b) to the body from the rear and insert it until (b) comes into contact with the panel for fixing.

● Panel mount adapter (Part No.: ZS-46-B)

Panel mount adapter + Front protective cover (Part No.: ZS-46-D)

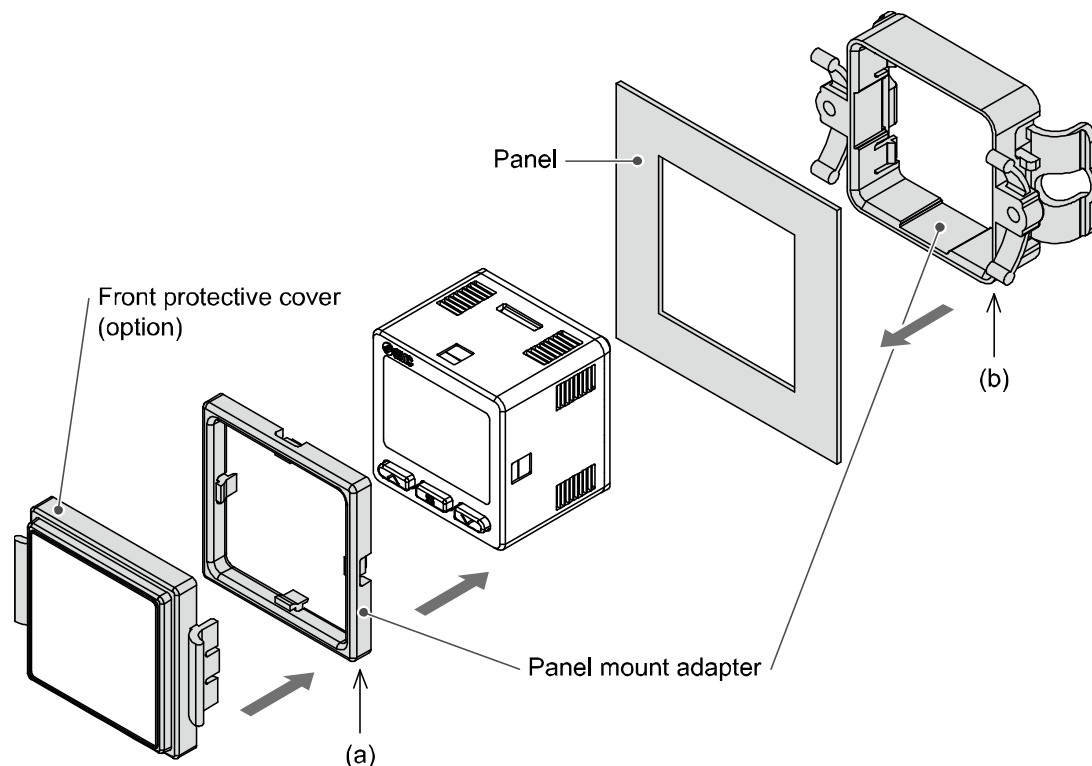

*: The panel mount adapter can be rotated through 90 degrees for mounting.

How to remove the panel mount adapter

● When removing the digital flow switch with panel mount adapter from the installation, pull it forward while expanding the hooks on each side as shown below. If the panel mount adapter is pulled forward with the hook caught, the product and the adapter may be damaged.

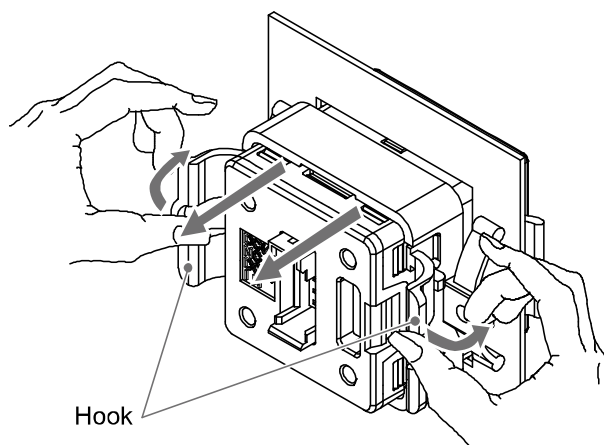

■Wiring

○Wiring connections

- Connections should be made with the power supply turned off.
- Use a separate route for the product wiring and any power or high voltage wiring. Otherwise, malfunction may result due to noise.
- If a commercially available switching power supply is used, be sure to ground the frame ground (FG) terminal. If the switching power supply is connected for use, switching noise will be superimposed and it will not be able to meet the product specifications. In that case, insert a noise filter such as a line noise filter/ferrite between the switching power supplies or change the switching power supply to the series power supply.

○How to use connector

Connector attachment/detachment

- When connecting the connector, insert it straight onto the pins, holding the lever and connector body, and lock the connector by pushing the lever hook into the concave groove on the housing.
- To detach the connector, remove the hook from the groove by pressing the lever downward, and pull the connector straight out.

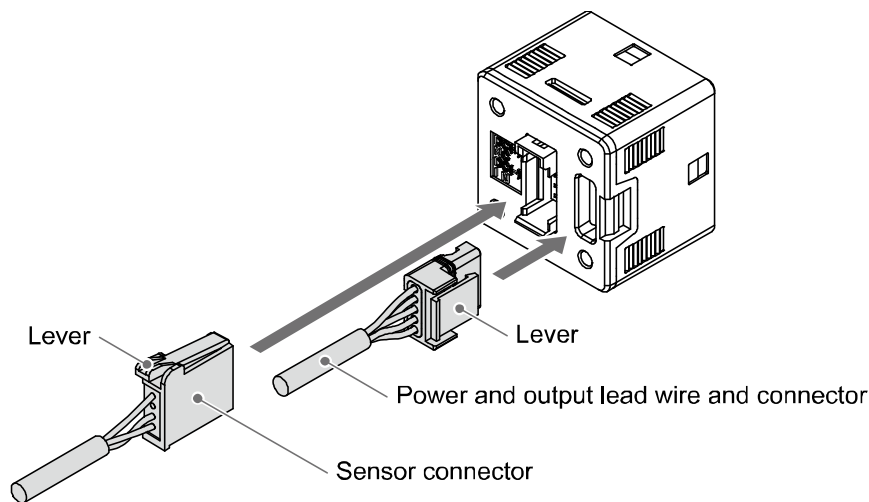

Connector pin out

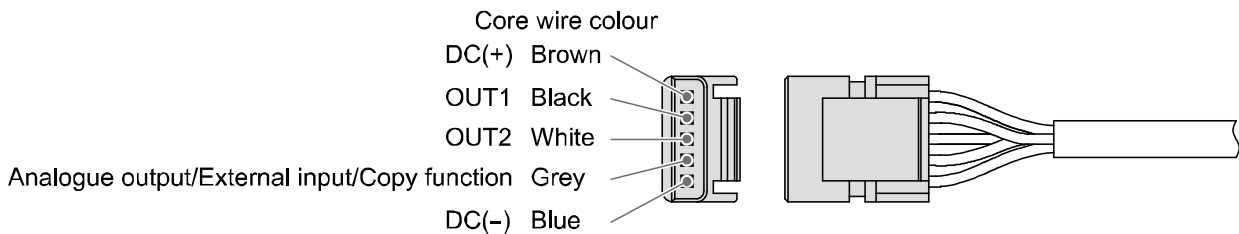

Attaching the connector to the sensor wire

- Strip the sensor wire as shown.
- Do not cut the insulator.
- Insert the corresponding wire colour shown in the table into the pin number printed on the sensor connector, to the bottom.

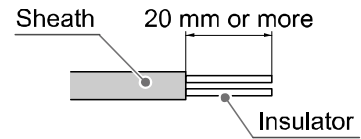

Pin no.	Wire colour *	Description
1	Brown	DC(+)
2	NC	-
3	Blue	DC(-)
4	White	IN

*: The wire colours shown are for the PFMB, PFMC, and PF3A7 series cables.

- Check that the above preparation has been performed correctly, then part A shown should be pressed in by hand to make temporary connection.

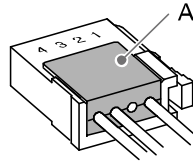

- Part A should then be pressed in using a suitable tool, such as pliers.

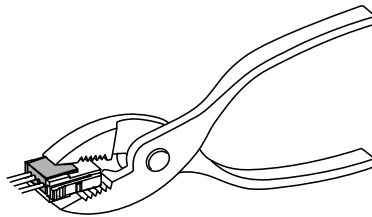

- The sensor connector cannot be re-used once it has been fully crimped. In cases of connection failure such as incorrect order of wires or incomplete insertion, please use a new connector.
- If the sensor is not connected correctly "LLL" or "HHH" will be displayed.

○ Internal circuit and wiring examples

PFG3#-#-#-####

● Output specification

-RT/-SV

• NPN open collector 2 output + Analogue output

Max. 30 V, 80 mA

Residual voltage: 1 V or less

RT: Analogue output 1 to 5 V, 0 to 10 V

Output impedance 1 kΩ

SV: Analogue output 4 to 20 mA

Max. load impedance

Power supply voltage 12 V: 300 Ω

Power supply voltage 24 V: 600 Ω

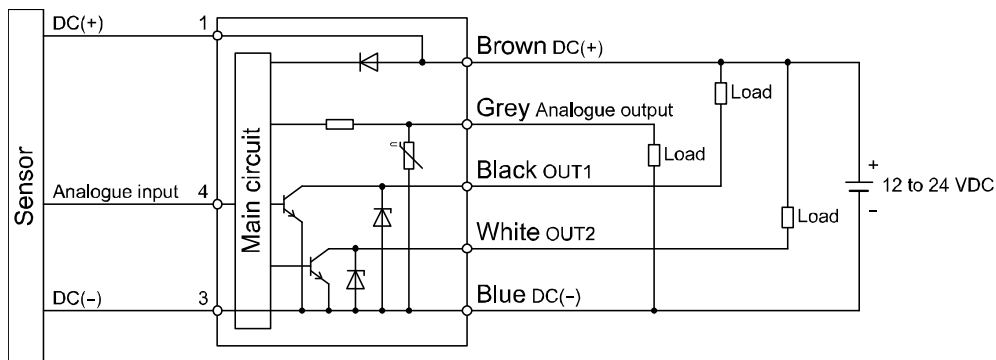

-RT/-SV

• NPN open collector 2 output + External input

Max. 30 V, 80 mA

Residual voltage: 1 V or less

External input: Input voltage 0.4 V or less (reed or solid state), 30 msec or more

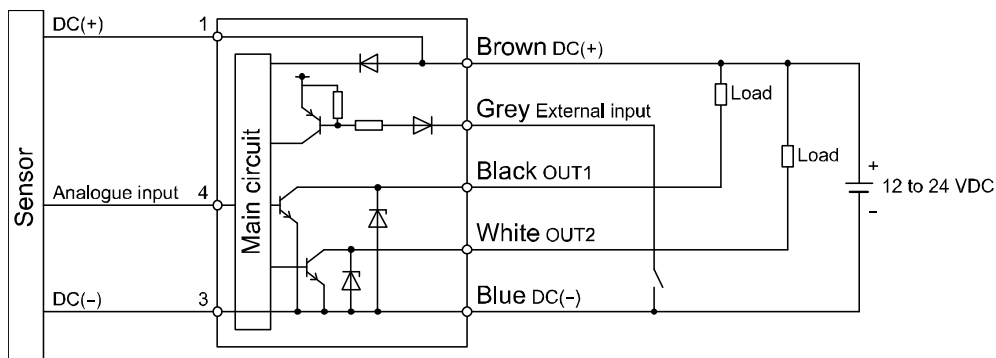

-RT/SV/XY

- NPN open collector 2 output + Copy function
- Max. 30 V, 80 mA
- Residual voltage: 1 V or less

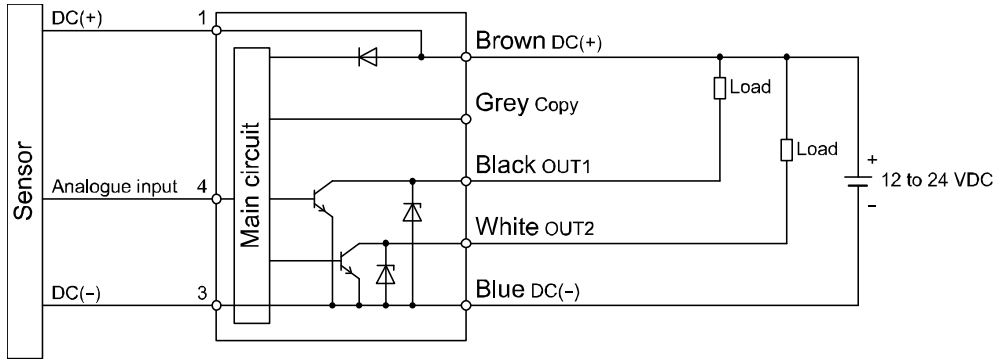

-RT/-SV

- PNP open collector 2 output + Analogue output
- Max. 80 mA
- Residual voltage: 1.5 V or less
- RT: Analogue output 1 to 5 V, 0 to 10 V
- Output impedance 1 k Ω
- SV: Analogue output 4 to 20 mA
- Max. load impedance
- Power supply voltage 12 V: 300 Ω
- Power supply voltage 24 V: 600 Ω

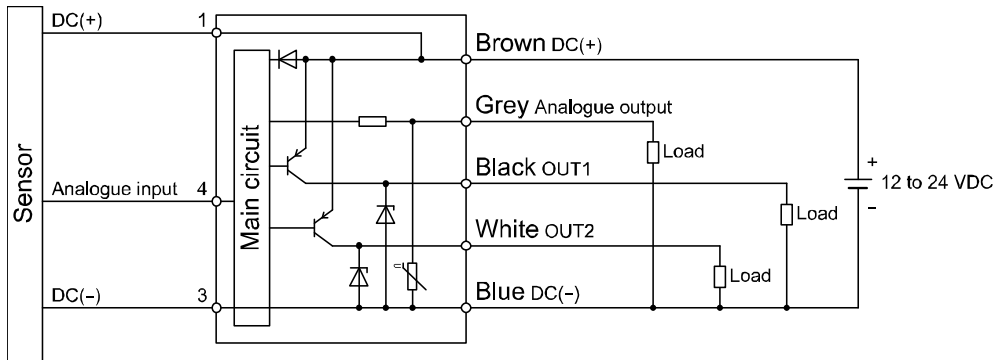

-RT/-SV

- PNP open collector 2 output + External input

Max. 80 mA

Residual voltage: 1.5 V or less

External input: Input voltage 0.4 V or less (reed or solid state), 30 msec or more

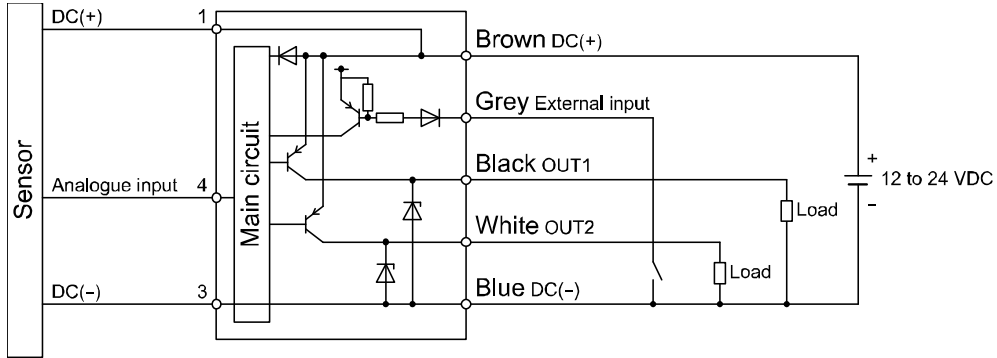

-RT/SV/XY

- PNP open collector 2 output + Copy function

Max.30 V, 80 mA

Residual voltage: 1.5 V or less

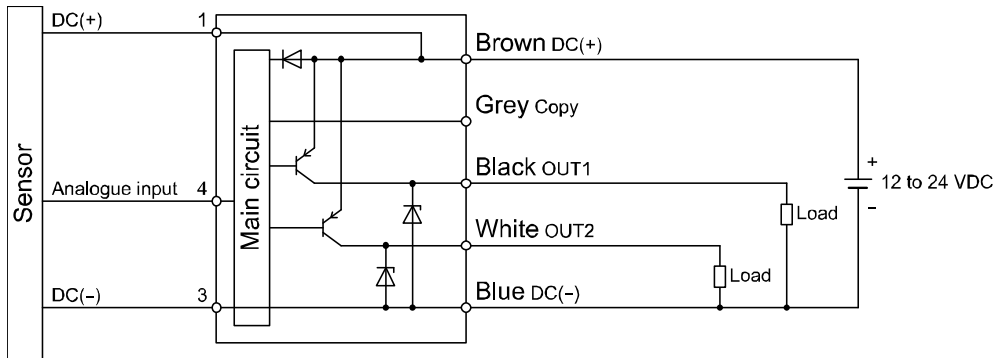

Example for wiring for accumulated pulse output

NPN open collector 2 output

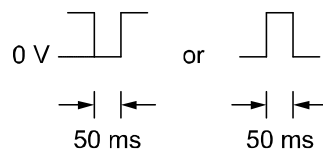
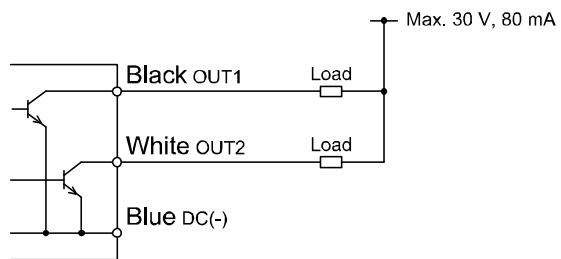

PNP open collector 2 output

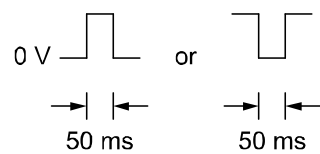
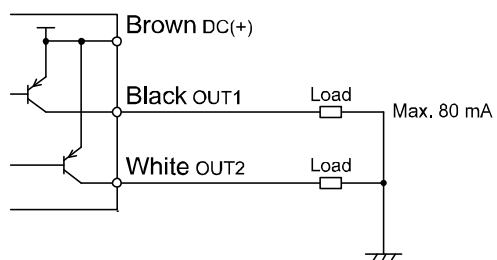

Flow Setting

Default settings

When the flow exceeds the set value, the switch will be turned on.

When the flow falls below the set value by the amount of hysteresis or more, the switch will be turned off.

The default setting is that the output will be turned ON at 1500 L/min when the flow range of the connected sensor is 3000 L/min.

Perform initial settings while referring to the "Outline of Settings" section (page 22).

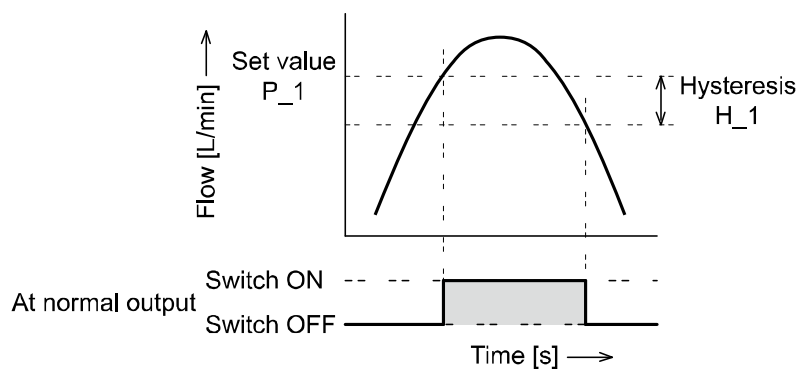

Outline of Settings

Power is supplied.



The product code is displayed for approximately 3 sec. after power is supplied. Then, measurement mode will be displayed.

*: When moving on to measurement mode, the switch operation will start.



[Initial setting] (Refer to page 23.)

Set the flow range, display unit and NPN/PNP output specifications of the connected sensor.



[Measurement mode]

Detects the flow after power is supplied, and indicates the display and switch operating status. This is the basic mode; other modes should be selected for set-point changes and other function settings.

Measurement mode screen

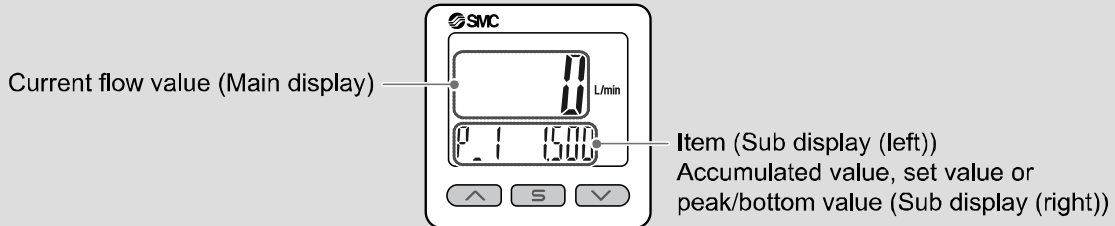

Sub display (Hysteresis mode)

In measurement mode, the display of the sub display can be temporarily changed by pressing the or buttons.

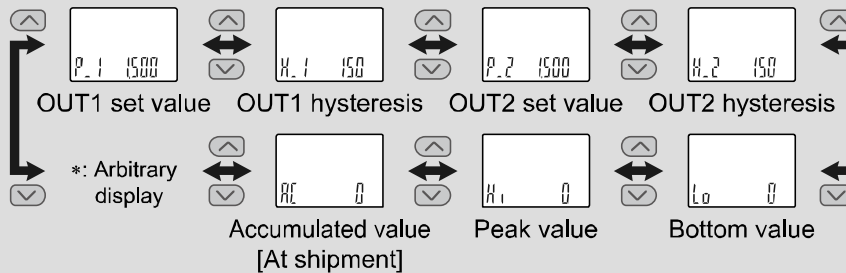

*: One arbitrary display mode can be added to the sub display by setting the [F10] sub display setting. (The default setting does not include arbitrary display.)

Press the button once.

Press the button between 1 and 3 sec.

Press the button between 3 and 5 sec.



[3 Step Setting Mode]

Set either of set value or hysteresis. (Refer to page 27.)

[Simple Setting Mode]

Select the set value and hysteresis. (Refer to page 29.)

[Function Selection Mode]

Change the function settings. (Refer to page 30.)

[Other Settings]

- Reset operation
- Key-lock function

(Refer to page 65.)

*: The outputs will continue to operate during setting.

*: 3 step setting mode, simple setting mode and function selection mode settings are reflected each other.

Initial Setting

Set the flow range, display unit and NPN/PNP output specifications of the connected sensor.

Measurement mode

Press the **[S]** button between 3 and 5 sec.

[F 0] Display the switching function of the flow range, display unit and switch output specifications.



Press the **[S]** button Move on to flow range setting.

Flow range setting

Press the **[↑]** or **[↓]** button to select the flow range.

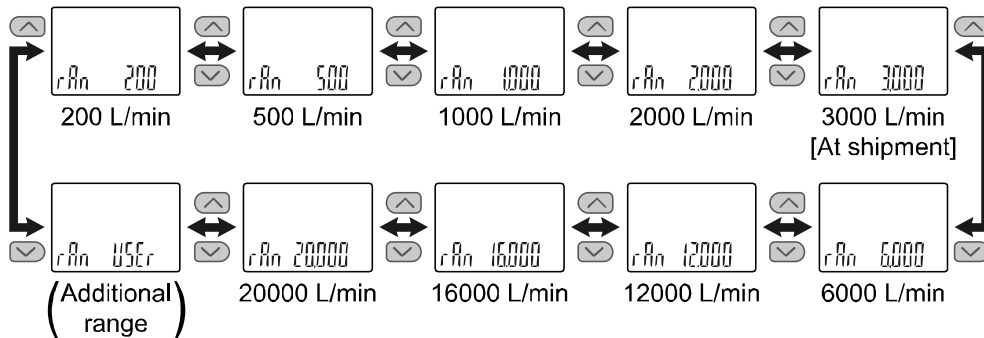

When [USER] is selected
Press the **[S]** button to move on to additional range minimum unit setting.

Additional range minimum unit setting

Press the **[↑]** or **[↓]** button to select the minimum unit.

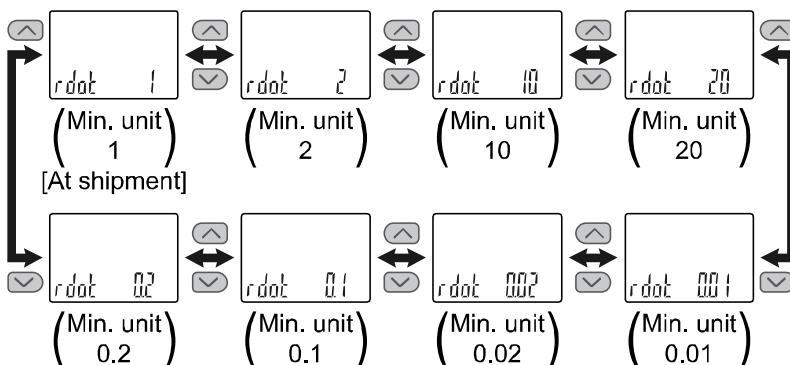

Press the **[S]** button to set.

Move on to setting of the lower limit of the additional rated range.
The lower limit of the rated range is the displayed value when the sensor input signal is 0%.

When other than [USER] is selected
Press the **[S]** button to move on to display unit setting.

Setting of the lower limit of the additional rated range

Press the or button to change the value. Press the button continuously to keep changing the value.



Set the value that is required to be displayed when the sensor input signal is 0%. The setting range is -1500 to 1500 digit.

Press the button to set.

Move on to setting of the upper limit of the additional rated range. The upper limit of the rated range is the displayed value when the sensor input signal is 100%.

Setting of the upper limit of the additional rated range

Press the or button to change the value. Press the button continuously to keep changing the value.



Set the value that is required to be displayed when the sensor input signal is 100%. The setting range is -1500 to 1500 digit.

Press the button to set.

Move on to setting of the accumulated additional rated range and additional range minimum unit.

Setting of the accumulated additional rated range and additional range minimum unit

Press the or button to select the accumulated range display or minimum unit for setting.

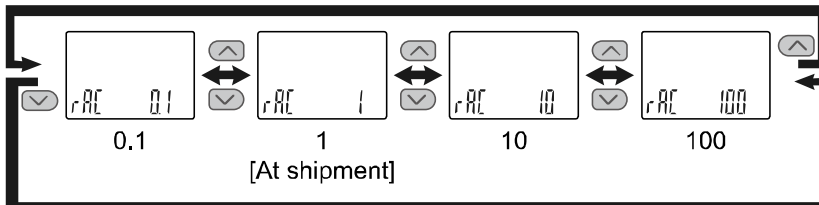

*: Settable minimum unit and converted value is different depending on the minimum unit for the additional range.

Press the button to set.

Move on to setting of the conversion of accumulated pulse of the additional range.

Setting of the conversion of accumulated pulse of the additional range

Press the or button to select the conversion of accumulated pulse of the additional range.

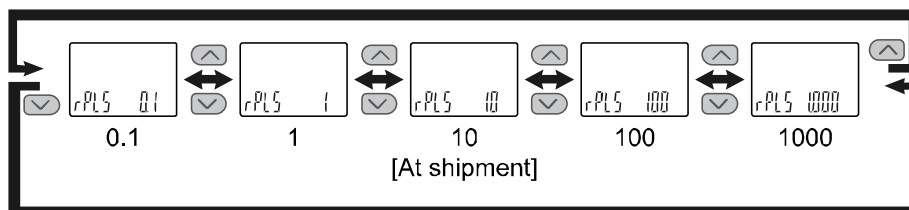
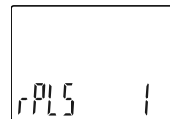

*: Settable minimum unit and converted value is different depending on the minimum unit for the additional range.

When the products with a units selection

When fixed to SI unit

Press the **S** button to set. ↓ Move on to display unit setting.

Display unit setting

Press the **▲** or **▼** button to change the display units.

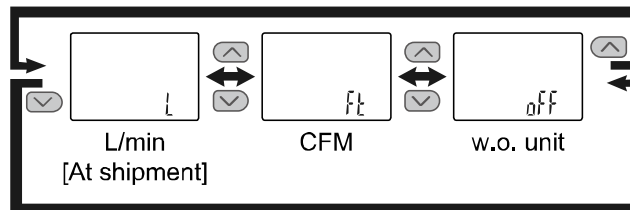

*: [CFM] cannot be selected if the additional range is set by the SI unit.

*: [w/o unit] cannot be selected if set items other than additional range are set with the units selection function.

Press the **S** button to set. ↓ Move on to switching setting of switch output NPN/PNP specifications.

Switching setting of switch output NPN/PNP specifications

The switch output of this product can be switched to NPN or PNP output in accordance with the user device construction.

The switch output specification can be selected by pressing **▲** or **▼** button.

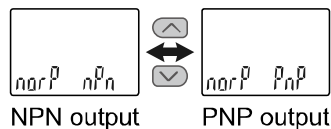

Press the **S** button to set. ↓ Return to function selection mode.

[F 0] Setting of the switching function of the flow range, display unit and switch output specifications is completed.

↓ Press the **S** button 2 seconds or longer.

Measurement mode
(Initial setting completed)

Perform the setting with the 3 step setting mode, simple setting mode and function selection mode.

Flow specification when [Ft] is selected by the units selection function

Model			PFG3#0							
Applicable SMC Flow Switch	Model		PFMB7201	PFMB7501 PFMC7501	PFMB7102 PFMC7102	PFMB7202 PFMC7202	PF3A703H	PF3A706H	PF3A712H	
	Rated flow range		0.08 to 7.06 cfm	0.2 to 17.7 cfm	0.4 to 35.3 cfm	0.8 to 70.6 cfm	1.1 to 105.9 cfm	2.2 to 211.9 cfm	4.5 to 423.8 cfm	
Flow	Set flow rate range	Instantaneous flow	-0.36 to 7.42 cfm	-0.9 to 18.6 cfm	-1.8 to 37.1 cfm	-3.6 to 74.2 cfm	-5.3 to 111.2 cfm	-10.6 to 222.6 cfm	-21.5 to 445.0 cfm	
		Accumulated flow	0 to 99,999,999, 999.9 ft ³	0 to 999,999,999,999 ft ³				0 to 999,999,999,990 ft ³		
	Min. setting unit	Instantaneous flow	0.01 cfm	0.1 cfm				0.2 cfm	0.5 cfm	
		Accumulated flow	0.1 ft ³	1 ft ³				10 ft ³		
	Accumulated volume per pulse		0.1 ft ³ /pulse			1 ft ³ /pulse			10 ft ³ /pulse	
Display	Displayable range	Instantaneous flow	-0.36 to 7.42 cfm	-0.9 to 18.6 cfm	-1.8 to 37.1 cfm	-3.6 to 74.2 cfm	-5.3 to 111.2 cfm	-10.6 to 222.6 cfm	-21.5 to 445.0 cfm	
		Accumulated flow	0 to 99,999,999, 999.9 ft ³	0 to 999,999,999,999 ft ³				0 to 999,999,999,990 ft ³		
	Min. display unit	Instantaneous flow	0.01 cfm	0.1 cfm				0.2 cfm	0.5 cfm	
		Accumulated flow	0.1 ft ³	1 ft ³				10 ft ³		

3 Step Setting Mode

3 step setting mode



In this mode, the set values can be input in just 3 steps.

Use this mode if the product is to be used straight away, after changing only the set values.

(The current flow value is displayed on the main display.)





<Operation>

[3 step setting mode (hysteresis mode)]

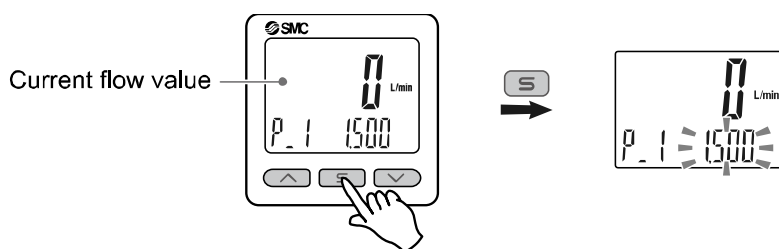
In the 3 step setting mode, the set value (P_1 or n_1, P_2 or n_2) and hysteresis (H_1, H_2) can be changed. Set the items on the sub display (set value or hysteresis) with  or  button. When changing the set value, follow the operation below. The hysteresis setting can be changed in the same way.

- (1) Press the  button once when the item to be changed is displayed on the sub display. The set value on the sub display (right) will start flashing.





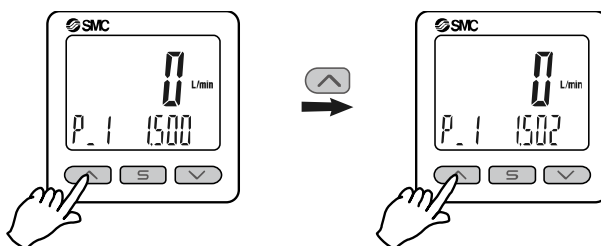

- (2) Press the  or  button to change the set value. The set value can be increased with  button and can be reduced with  button.

- Press the  button once to increase the value by one digit, press and hold to continuously increase.

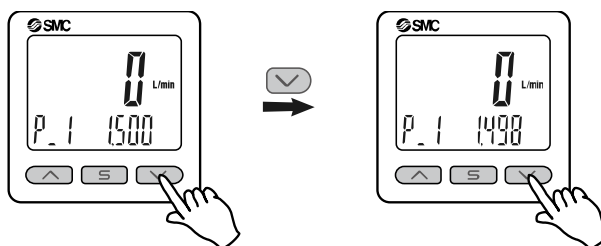

- Press the  button once to reduce the value by one digit, press and hold to continuously reduce.



- When the  and  buttons are pressed and held simultaneously for 1 second or longer, the set value is displayed as [- - -], and the set value will be the same as the current flow value automatically (snap shot function (Refer to page 65.)). Afterwards, it is possible to adjust the value by pressing the  or  button.

- (3) Press the  button to complete the setting.

The Flow switch turns on within a set flow range (OUT1: from P1L to P1H, OUT2: from P2L to P2H) during window comparator mode. Set P1L/P2L, the lower limit of the switch operation, and P1H/P2H, the upper limit of the switch operation and WH1/WH2 (hysteresis) following the instructions given on page 27. (When reversed output is selected, the sub display (left) shows [n1L/n2L] and [n1H/n2H].)

In accumulated output mode, the switch will start at the set accumulated flow rate. Set each P1/P2 (set value), referring to the Setting method on page 27. (When reversed output is selected, the sub display (left) shows [n1/n2].)

Please refer to the "List of switch output modes" on page 40 for the relationship between the set values and operation.

- *: Set OUT2 in the same way.
- *: Setting of the normal/reverse output switching and hysteresis/window comparator mode switching are performed with the function selection mode [F 1] Setting of OUT1 and [F 2] Setting of OUT2.

Simple Setting Mode

<Operation>

[Simple setting mode (hysteresis mode)]

In the simple setting mode, the set value and hysteresis can be changed while checking the current flow value (main display).

- (1) Press and hold the **S** button between 1 and 3 seconds in measurement mode. [SEt] is displayed on the main display. When the button is released while in the [SEt] display, the current flow value is displayed on the main display, [P_1] or [n_1] is displayed on the sub display (left), and the set value is displayed on the sub display (right) (Flashing).

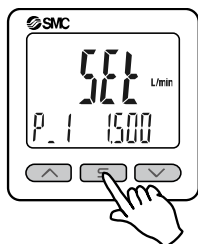

- (2) Change the set value with **▲** or **▼** button, and press the **S** button to set the value. Then, the setting moves to hysteresis setting. (The snap shot function can be used. (Refer to page 65.))

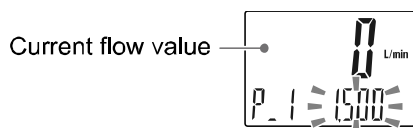

- (3) Change the set value with **▲** or **▼** button, and press the **S** button to set the value. Then, the setting moves to setting of OUT2. (The snap shot function can be used. (Refer to page 65.))

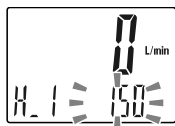

- (4) Press the **S** button for less than 2 seconds to complete the OUT1 setting. [P_2] or [n_2] is displayed on the sub screen (left). Continue with setting the OUT2. Press and hold the **S** button for 2 seconds or longer to complete the setting. The product will return to measurement mode.

*1: Selected items (1) to (4) become valid after pressing the **S** button.

*2: After enabling the setting by pressing the **S** button, it is possible to return to measurement mode by pressing the **S** button for 2 seconds or longer.

*3: When the output mode (refer to page 36) is set to error output or switch output OFF, the simple setting mode cannot be used.

In the window comparator mode, set P1L/P2L, the lower limit of the switch operation, and P1H/P2H, the upper limit of the switch operation and WH1/WH2 (hysteresis) following the instructions given on page 29. (When reversed output is selected, the sub display (left) shows [n1L/n2L] and [n1H/n2H].)

Set each P1/P2 (set value), referring to the Accumulated output mode on page 29.

(When reversed output is selected, the main screen displays n1/n2).

Refer to the "List of output modes" on page 40 for the relationship between the set values and operation.

Function Selection Mode

■Function selection mode

In measurement mode, press the **[S]** button between 3 and 5 seconds, to display [F 0]. Select to display the function to be changed [F□□]. Press and hold the **[S]** button for 2 seconds or longer in function selection mode to return to measurement mode.

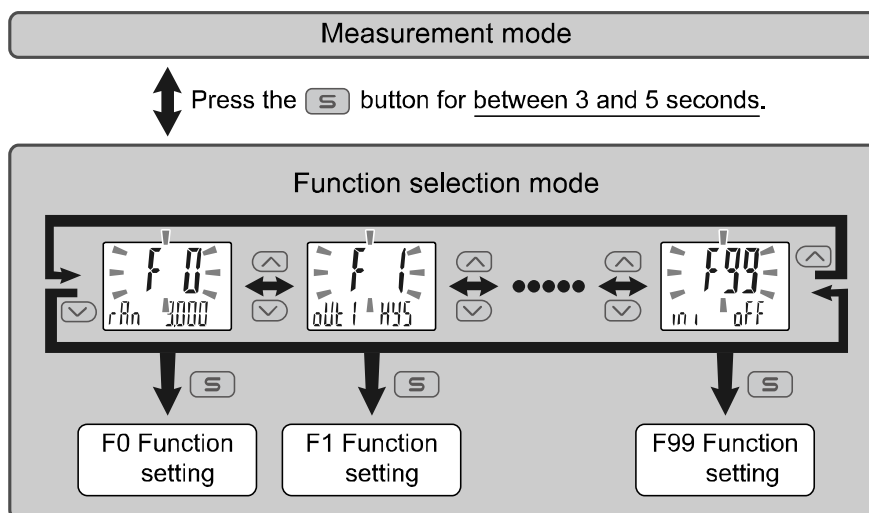

*: Some products do not have all the functions. If no function is available or selected due to configuration of other functions, [- - -] is displayed on the sub display (right).

■Default setting

The default setting is as follows.

If no problem is caused by this setting, keep these settings.

To change a setting, enter function selection mode.

- Switching function of [F 0] Flow range, display unit and switch output specifications ➡ Page 32

Item	Default setting
Flow range	3000 L/min
Display units *1	L
Switch output specifications	NPN

*1: This setting is only available for models with the units selection function.

- [F 1] Setting of OUT1 ➡ Page 36

Item	Explanation	Default setting
Output mode	Either hysteresis mode, window comparator mode, accumulated output, accumulated pulse, error output or switch output off can be selected.	Hysteresis mode
Reversed output	Selects which type of switch output is used, normal or reversed.	Normal output
Flow setting	Sets the ON and OFF point of the switch output.	1500 L/min
Hysteresis	Appropriate setting of the hysteresis will prevent the switch output from chattering.	150 L/min
Delay time	Delay time of the switch output can be selected.	0.00 s
Display colour	Select the display colour.	Output ON: Green Output OFF: Red (Linked to OUT1)

●[F 2] Setting of OUT2 ➡ Page 41

Item	Explanation	Default setting
Output mode	Either hysteresis mode, window comparator mode, accumulated output, accumulated pulse, error output or switch output off can be selected.	Hysteresis mode
Reversed output	Selects which type of switch output is used, normal or reversed.	Normal output
Flow setting	Sets the ON and OFF point of the switch output.	1500 L/min
Hysteresis	Appropriate setting of the hysteresis will prevent the switch output from chattering.	150 L/min
Delay time	Delay time of the switch output can be selected.	0.00 s
Display colour	Select the display colour.	Output ON: Green Output OFF: Red (Linked to OUT1)

●Other parameter settings

Item	Page	Default setting
[F 3] Digital filter setting	Page 44	0.00 s
[F 5] FUNC terminal function setting *2	Page 45	Analogue output: 1 to 5 V/4 to 20 mA External input: Accumulated value reset
[F10] Sub display setting	Page 48	dEF
[F14] Display with zero cut-off setting	Page 50	1.0%F.S.
[F30] Accumulated value hold setting	Page 52	OFF
[F80] Power saving mode	Page 53	OFF
[F81] Security code	Page 54	OFF
[F90] Setting of all functions	Page 56	OFF
[F96] Sensor input/External input signal status display	Page 58	No configurable items
[F97] Copy setting	Page 59	No configurable items
[F98] Output check	Page 62	Normal output
[F99] Reset to default settings	Page 64	OFF

*2: This function is available for models with analogue output.

■[F 0] Flow range, display units and switch output specification

Flow range setting

A Flow range which is suitable for the connected sensor can be selected. In addition, the required range can be set and displayed. (Custom range)

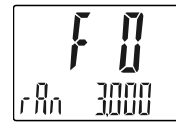

- Relationship between analogue input and digital display

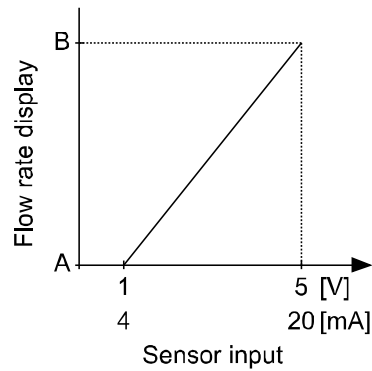

Set value	A	B
200	0 L/min	200 L/min
500	0 L/min	500 L/min
1000	0 L/min	1000 L/min
2000	0 L/min	2000 L/min
3000(Default)	0 L/min	3000 L/min
6000	0 L/min	6000 L/min
12000	0 L/min	12000 L/min
16000	0 L/min	16000 L/min
20000	0 L/min	20000 L/min
USER	Input value (setting)	Input value (setting)

<Operation>

Press the or button in function selection mode to display [F 0].

Press the button. Move on to flow range setting.

Flow range setting

Press the or button to select the flow range.

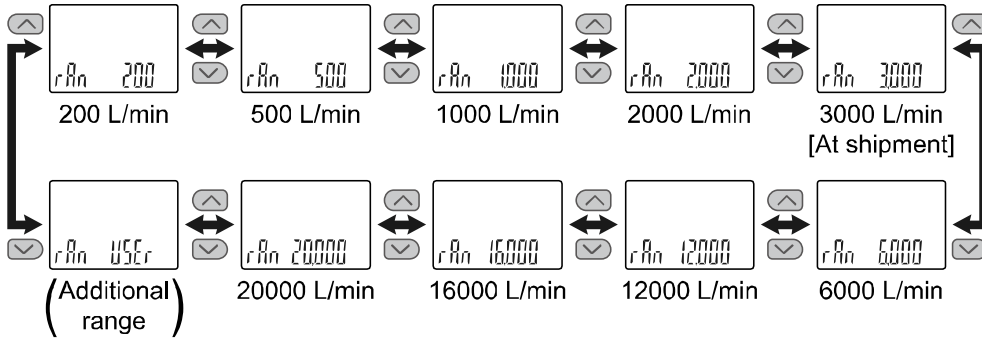

When [USER] is selected
Press the button to move on to additional range minimum unit setting.

Additional range minimum unit setting

Press the or button to select the minimum unit.

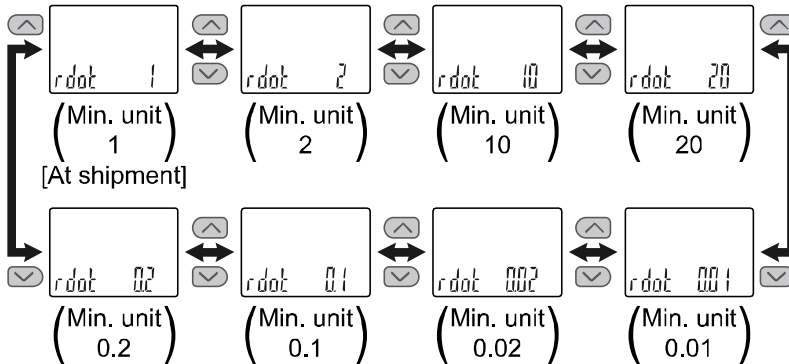

Press the button to set. Move on to setting of the lower limit of the additional rated range. The lower limit of the rated range is the displayed value when the sensor input signal is 0%.

When other than [USER] is selected
Press the button to move on to display unit setting.

Setting of the lower limit of the additional rated range

Press the or button to change the value. Press the button continuously to keep changing the value.



Set the value that is required to be displayed when the sensor input signal is 0%. The setting range is -1500 to 1500 digit.

Press the button to set.

Move on to setting of the upper limit of the additional rated range. The upper limit of the rated range is the displayed value when the sensor input signal is 100%.

Setting of the upper limit of the additional rated range

Press the or button to change the value. Press the button continuously to keep changing the value.



Set the value that is required to be displayed when the sensor input signal is 100%. The setting range is -1500 to 1500 digit.

Press the button to set.

Move on to setting of the accumulated additional rated range and additional range minimum unit.

Setting of the accumulated additional rated range and additional range minimum unit

Press the or button to select the accumulated range display or minimum unit for setting.

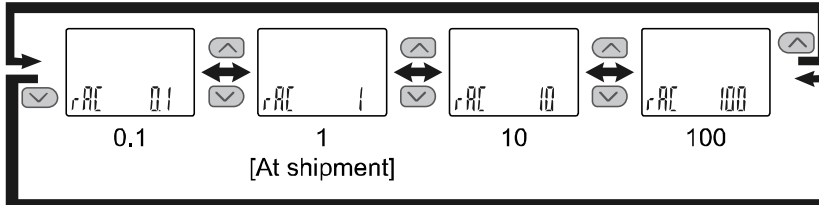

*: Settable minimum unit and converted value is different depending on the minimum unit for the additional range.

Press the button to set.

Move on to setting of the conversion of accumulated pulse of the additional range.

Setting of the conversion of accumulated pulse of the additional range

Press the or button to select the conversion of accumulated pulse of the additional range.

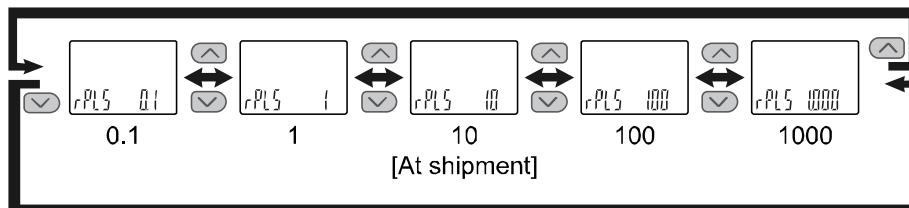
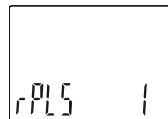

*: Settable minimum unit and converted value is different depending on the minimum unit for the additional range.

When the products with a units selection

When fixed to SI unit

Press the **S** button to set. ↓ Move on to display unit setting.

Display unit setting

Press the **▲** or **▼** button to change the display units.

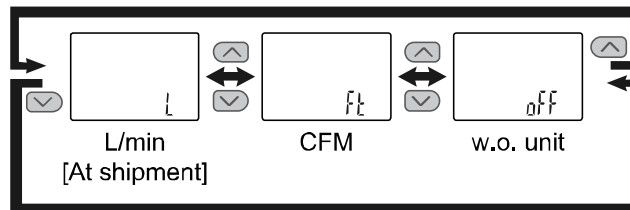

*: [CFM] cannot be selected if the additional range is set by the SI unit.

*: [w/o unit] cannot be selected if set items other than additional range are set with the units selection function.

Press the **S** button to set. ↓ Move on to switching setting of switch output NPN/PNP specifications.

Switching setting of switch output NPN/PNP specifications

The switch output of this product can be switched to NPN or PNP output in accordance with the user device construction.

The switch output specification can be selected by pressing **▲** or **▼** button.

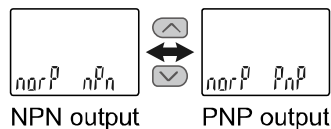

Press the **S** button to set. ↓ Return to function selection mode.

[F 0] Setting of the switching function of the flow range, display unit and switch output specifications is completed.

*: Refer to the flow specification when [F] is selected by the units selection function. (page 26)

■ [F 1] Setting of OUT1

Set the output mode of OUT1.

The output signal turns ON when the flow is greater than the set value. When the output is ON the LED is green and when the output is OFF the LED is red as the default setting.

Refer to the "List of output modes" on page 40 for the relationship between the set items and the operation.

<Operation>

Press the or button in function selection mode to display [F 1].

Press the button. Move on to output mode setting.

Output mode setting

Press the or button to select the required output mode.

Press the button to set. Move on to reversed output setting.

Reversed output setting

Press the or button to select the reversed output.

Press the button to set. Move on to flow setting.

Flow setting

Set the flow based on the setting method on page 27.

Hysteresis mode: [P_1]
 Window comparator mode: [P1L] [P1H]
 "P" is changed to "n" as [1_P] → [1_n] when reversed output is selected.
 The snap shot function can also be used.
 (Refer to page 65.)

[AC] When accumulated output is selected

Press the button to move on to accumulated output setting.
 (Refer to page 38.)

[OFF] Switch output OFF is selected.

Press the button to move on to display colour setting.

[Err] Error output, [PLS] When pulse output is selected

Press the button to move on to display colour setting.

Press the button to set. Move on to hysteresis setting.

Hysteresis setting

Set the flow referring to the setting method on page 27.



Hysteresis mode: [H_1]
Window comparator mode: [WH1]
The snap shot function can also be used.
(Refer to page 65.)

Press the **S** button to set. ↓ Move on to delay time setting.

Delay time setting

The delay time of the switch output can be set by pressing the **▲** or **▼** button. Setting the Delay time can prevent the output from chattering.



Delay time settable range :0.00 to 60.00 [S]

Press the **S** button to set. ↓ Move on to display colour setting.

Display colour setting

Press the **▲** or **▼** button to select the display colour.



Col 1500	Col 1500	Col 2500	Col 2500	Col red	Col Grn
ON: Green OFF: Red (Linked to OUT1)	ON: Red OFF: Green (Linked to OUT1)	ON: Green OFF: Red (Linked to OUT2)	ON: Red OFF: Green (Linked to OUT2)	Normally: Red	Normally: Green

Press the **S** button to set. ↓ Return to function selection mode.

[F 1] Setting of OUT1 completed

*1: The selected item becomes valid after pressing the **S** button.

*2: After enabling the setting by pressing the **S** button, it is possible to return to the measurement mode by pressing the **S** button for 2 seconds or longer.

([AC] When accumulated output is selected)

Accumulated output setting

Press the or button to select accumulated output.

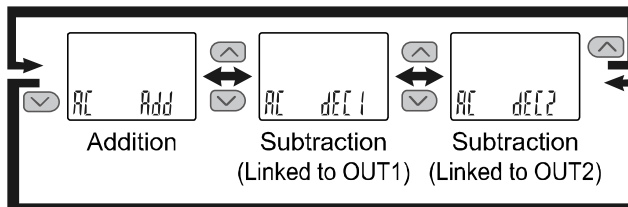
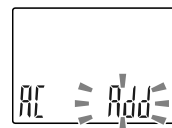

Press the button to set. Move on to accumulated value setting.

Accumulated value setting

Perform the accumulated value setting (Refer to page 39.)

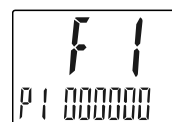

Press the button to set. Move on to display colour setting.

Display colour setting

Press the or button to select the display colour.

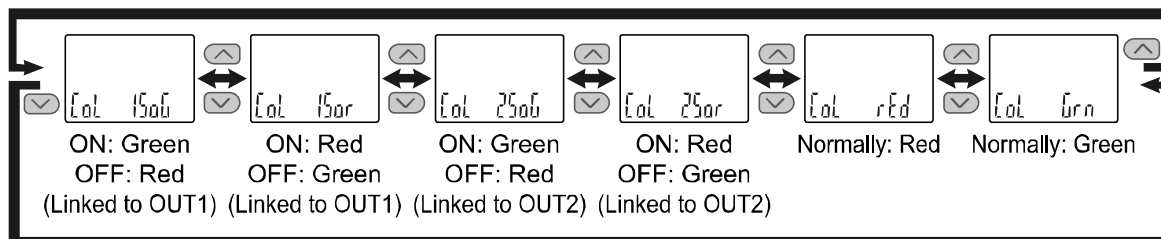
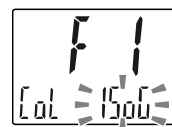

Press the button to set. Return to function selection mode.

[F 1] Setting of OUT1 completed

*1: The selected item becomes valid after pressing the button.

*2: After enabling the setting by pressing the button, it is possible to return to the measurement mode by pressing the button for 2 seconds or longer.

Setting of the first 6 digits

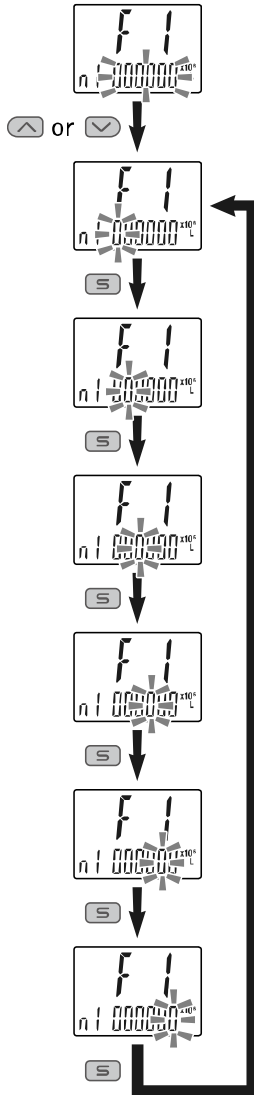

When the **S** button is pressed for 1 second or longer, [000000] will start flashing.

Press the **S** button again.

Setting of the next 6 digits

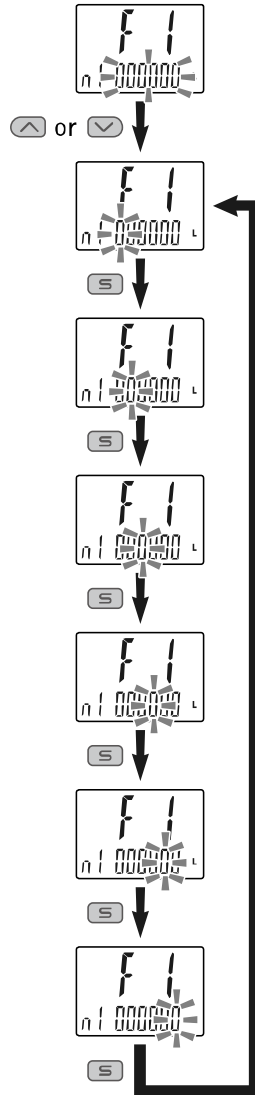

When the **S** button is pressed for 1 second or longer, the flashing will stop.

The sub screen displays the value, and the leftmost digit of the set value will start flashing. (The required accumulated value should be input one digit at a time).

Press the **▲** and **▼** buttons to change the value.

Press the **S** button to move on to input of the next right digit.

Pressing the **S** button again will select the next digit to the right.

After the input of the first 6 digits is complete, press the **S** button for 1 second or longer. [000000] will start flashing.

Press the **S** button again to confirm the values of the first 6 digits and move on to input of the next 6 digits.

After the input of the next 6 digits is complete, press the **S** button for 1 second or longer to confirm.

*: As the unit for setting of the first 6 digits, [x 10⁶] and [L] will be displayed.

•List of output modes

Select the operation required from the table below. Characters in () are for OUT2.

	Normal output	Reversed output
Hysteresis mode		
Window comparator mode		
Accumulated output mode (Increment)		
Accumulated output mode (Decrement)		
Accumulated pulse output mode		
Error output mode		
OFF mode		

*: Applicable errors are Er0, 1, 2, 4, 6 to 8, 14, and 40.

If the point at which the switch output changes is outside of the set flow rate range due to the selection of normal or reversed output, the hysteresis value will be automatically adjusted.

■[F 2] Setting of OUT2

Set the output mode of OUT2.

The output signal turns ON when the flow is greater than the set value.

Refer to the "List of output modes" on page 40 for the relationship between the set items and the operation.

<Operation>

Press the or button in function selection mode to display [F 2].

Press the button. Move on to output mode setting.

Output mode setting

Press the or button to select the required output mode.

Press the button to set. Move on to reversed output setting.

Reversed output setting

Press the or button to select the reversed output.

Press the button to set. Move on to flow setting.

Flow setting

Set the flow based on the setting method on page 27.

Hysteresis mode: [P_2]
 Window comparator mode: [P2L] [P2H]
 "P" is changed to "n" as [2_P] → [2_n] when reversed output is selected.
 The snap shot function can also be used.
 (Refer to page 65.)

Press the button to set. Move on to hysteresis setting.

[AC] When accumulated output is selected

Press the button to move on to accumulated output setting.
 (Refer to page 38.)

[Err] Error output, [PLS] When pulse output is selected

Press the button to move on to display colour setting.

[OFF] Switch output OFF is selected.

Press the button to move on to display colour setting.

Hysteresis setting

Set the flow referring to the setting method on page 27.



Hysteresis mode: [H_2]
Window comparator mode: [WH2]
The snap shot function can also be used.
(Refer to page 65.)

Press the **S** button to set. ↓ Move on to delay time setting.

Delay time setting

The delay time of the switch output can be set by pressing the **▲** or **▼** button. Setting the Delay time can prevent the output from chattering.



Delay time settable range :0.00 to 60.00 [S]

Press the **S** button to set. ↓ Move on to display colour setting.

Display colour setting

Press the **▲** or **▼** button to select the display colour.



Col 1500	Col 1500	Col 2500	Col 2500	Col red	Col Grn
ON: Green OFF: Red (Linked to OUT1)	ON: Red OFF: Green (Linked to OUT1)	ON: Green OFF: Red (Linked to OUT2)	ON: Red OFF: Green (Linked to OUT2)	Normally: Red	Normally: Green

Press the **S** button to set. ↓ Return to function selection mode.

[F 2] Setting of OUT2 completed

*1: The selected item becomes valid after pressing the **S** button.

*2: After enabling the setting by pressing the **S** button, it is possible to return to the measurement mode by pressing the **S** button for 2 seconds or longer.

([AC] When accumulated output is selected)

Accumulated output setting

Press the or button to select accumulated output.

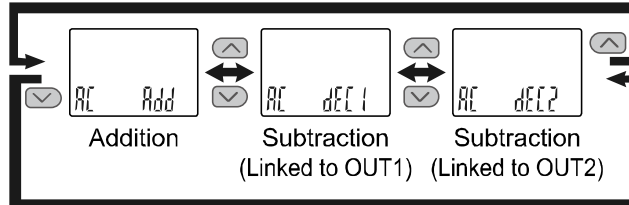

Press the button to set. Move on to accumulated value setting.

Accumulated value setting

Perform the accumulated value setting (Refer to page 39.)

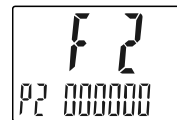

Press the button to set. Move on to display colour setting.

Display colour setting

Press the or button to select the display colour.

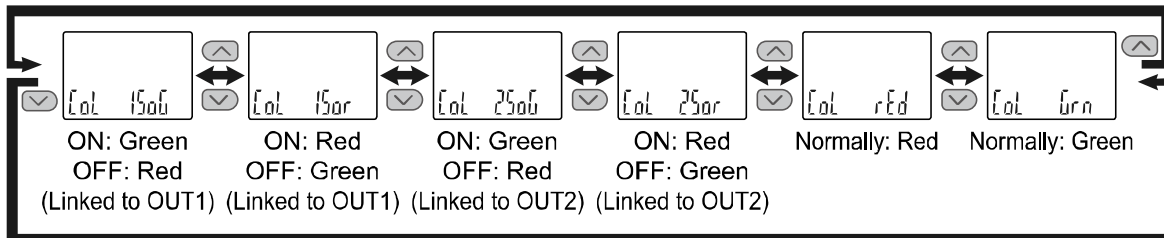
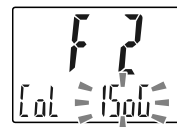

Press the button to set. Return to function selection mode.

[F 2] Setting of OUT2 completed

*1: The selected item becomes valid after pressing the button.



*2: After enabling the setting by pressing the button, it is possible to return to the measurement mode by pressing the button for 2 seconds or longer.

■[F 3] Digital filter setting

The digital filter can be selected to filter the flow measurement (0 to 30 sec.).



Output chattering or display flicker in measurement mode can be reduced by setting the digital filter.

<Operation>

Press the  or  button in function selection mode to display [F 3].

Press the  button.  Move on to digital filter setting.

Digital filter setting

Press the  or  button to select the digital filter.

Digital filter set range: 0.00 to 30.00 [S]

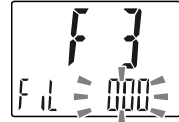

Press the  button to set.  Return to function selection mode.

[F 3] Digital filter setting completed

*1: Each set value is a guideline for 90% response time.

*2: The Switch output and flow display/analogue output are affected.

When only the switch output needs to be filtered, select and adjust the delay time setting. (page 37 and 42)

■[F 5] FUNC terminal function setting

Analogue output, external input or copy function can be selected.

*: Do not connect the grey wire when changing the setting.

- When the analogue output is selected

When the product with analogue voltage output is used, the output of 1 to 5 V or 0 to 10 V can be selected. A flow value corresponding to 5 V (10 V) or 20 mA can be selected with the analogue output free range function.

- When the external input is selected

The Accumulated Flow, Peak Value and Bottom Value can be reset remotely by an external input signal.

- Accumulated flow external reset: A function to reset the accumulated flow value when an external input signal is applied.

In accumulated increment mode, the accumulated flow value will reset to zero, and then increase from zero.

In accumulated decrement mode, the accumulated flow value will reset to a set value, and then decrease from the set value.

*: When the Accumulated Value has been stored to memory, every time the Accumulated Value External Reset is activated, the memory will be accessed. Take into consideration the maximum number of times the memory can be accessed is 1.5 million times.

When using the product, it should be considered that the total number of external input resets and accumulated values stored must not exceed 1.5 million cycles.

- Peak/Bottom value reset: A function to clear the peak value or bottom value in response to an external input signal.

- When the copy function is selected

The set value of the monitor copy source can be copied.

<Operation>

Press the or button in function selection mode to display [F 5].

Press the button. Moves on to FUNC terminal function setting.

FUNC terminal function setting

Press the or button to select the required function.

Analogue voltage output

[oUt] (Analogue output)

Press the button to move on to analogue output setting.

External input [in]

Press the button to move on to external input setting.

Analogue current output

[oUt] (Analogue output)

Press the button to move on to free range setting.

Copy [CoPY]

Press the button to set.

Return to function selection mode.

Analogue output setting

Press the or button to select the required analogue output.

External input setting

Press the or button to select the required external input.

Press the button to set.
Move on to free range setting.

Press the button to set.

Return to function selection mode.

Free range setting

Press the or button to select the free range setting.

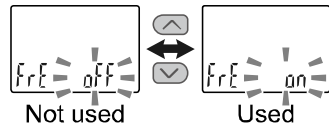

[on] is enabled

Press the button to move on to set value.

[oFF] not used

Press the button to set.
Return to function selection mode.

Set value

Use the and buttons to enter the flow value to correspond with the full span analogue output (5 V or 10 V or 20 mA).



The entered flow value can be in the range: 10% of the maximum rated flow, to the max. displayable range.

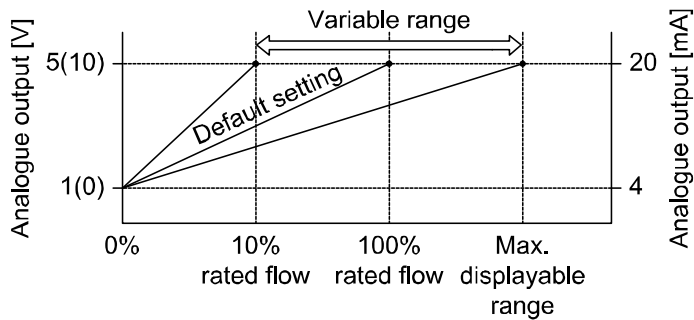

Press the button to set.

Return to function selection mode.

[F 5] FUNC terminal function setting completed

■[F10] Sub display setting

Change the display style of the sub display.

- Initial setting (standard): Accumulated value, set value for OUT, peak value, or bottom value is displayed.
- Addition of line name: A line name can be added to the default display.
A line name can be entered comprising of up to 5 characters and/or numbers.
- Setting of display off: Display off can be set for the default display.

*: Addition of line name and the display off cannot be set at the same time.

Detailed settings are shown in the pages from 49.

<Operation>

Press the or button in function selection mode to display [F10].

Press the button. Move on to sub display setting.

Sub display setting

Press the or button to select the required sub display style.

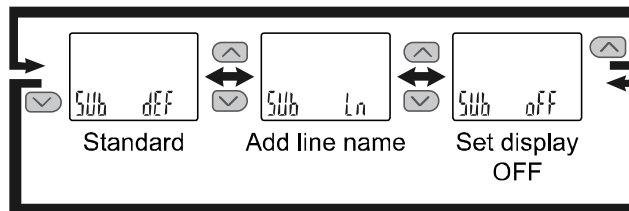

When [Ln] Addition of line name is to be added
Press the button to move on to input of line name.

Input of line name

Function to display the specified character string on the sub display.

Press the or button to input the line name to be displayed on the sub display (right).
Press the button to make the next digit to the right flash. Input the line name.

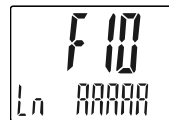

(The most significant digit flashes when the button is pressed at the least significant digit).

The order of displayed characters is A → b → ... → Y → (Z) → 0 → 1 → ... → 9 → symbol → space.

(Characters which can be displayed are different for 1 digit on the left and 5 digits on the right).

The set line name flashes by pressing the button for 1 second or longer.

(At this point, the setting of the line name is not complete.)

Setting of [dEF] default, or [oFF] display OFF

Press the button to set. Return to function selection mode.

Press the button to set. Return to function selection mode.

[F10] Sub display setting completed

- Characters which can be displayed for each digit are as follows.
Characters Q, X, Z, /, or * cannot be displayed.

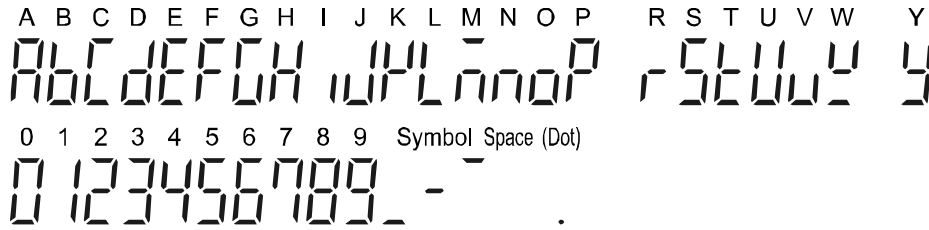

<Sub display>

•Standard

The Standard display function displays the items and values on the sub display.
The displayed item varies depending on the setting of the output mode. Select the displayed items by pressing the or button in measurement mode.

(Hysteresis mode, error output, switch output off)

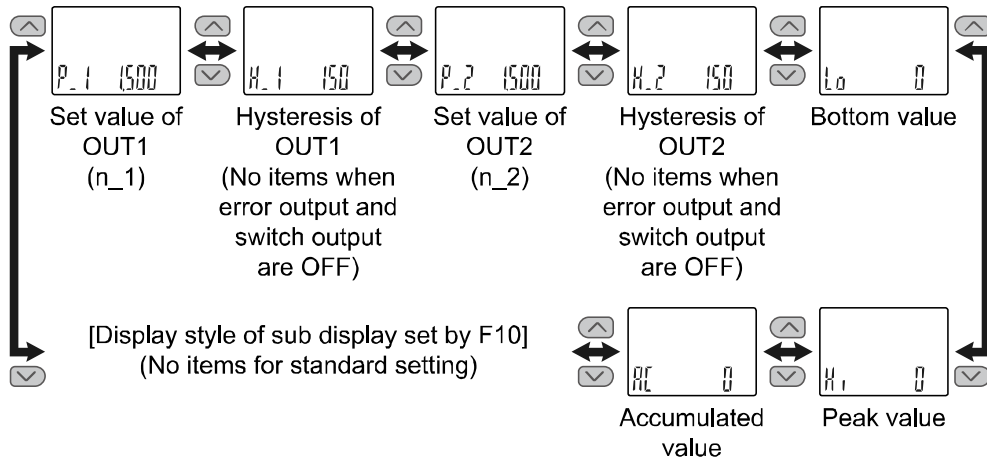

(Window comparator mode)

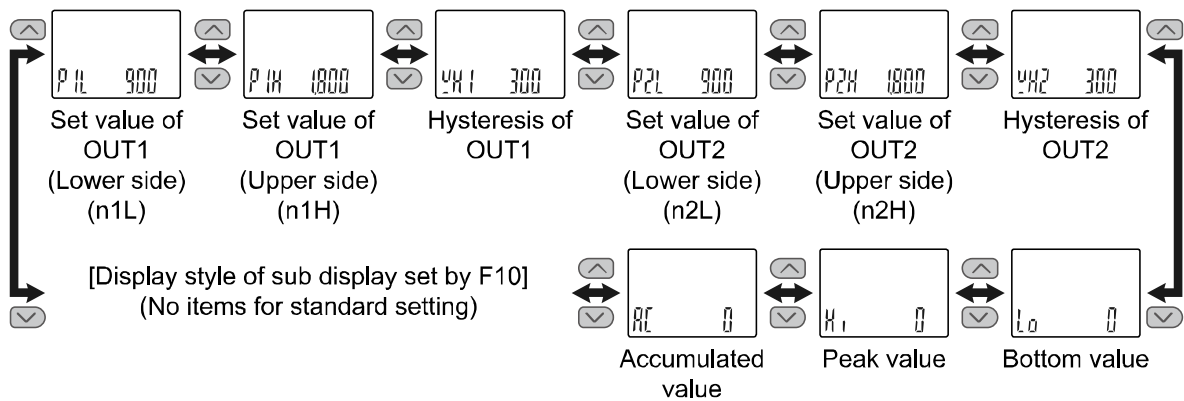



■[F14] Display with zero cut-off setting



When the flow is close to 0 L/min., the product rounds the value down and zero will be displayed. This is adjustable within the range of $\pm 10\%$ F.S. of the flow range.

<Operation>

Press the  or  button in function selection mode to display [F14].

Press the  button.  Move on to display with zero cut-off setting.

Display with zero cut-off setting

Press the  or  button to select the display zero-cut setting.

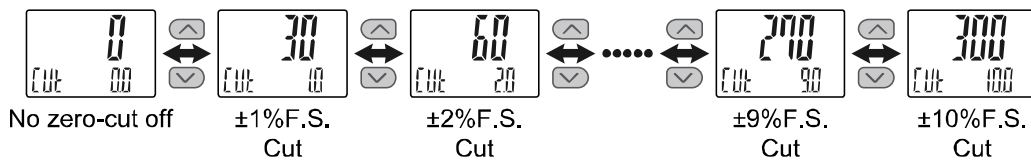

*: The display above is an example when 3000 L/min flow range is selected.

*: When the actual flow is smaller than the displayed value in the upper line, zero will be displayed.

Example: Flow range 3000 L/min

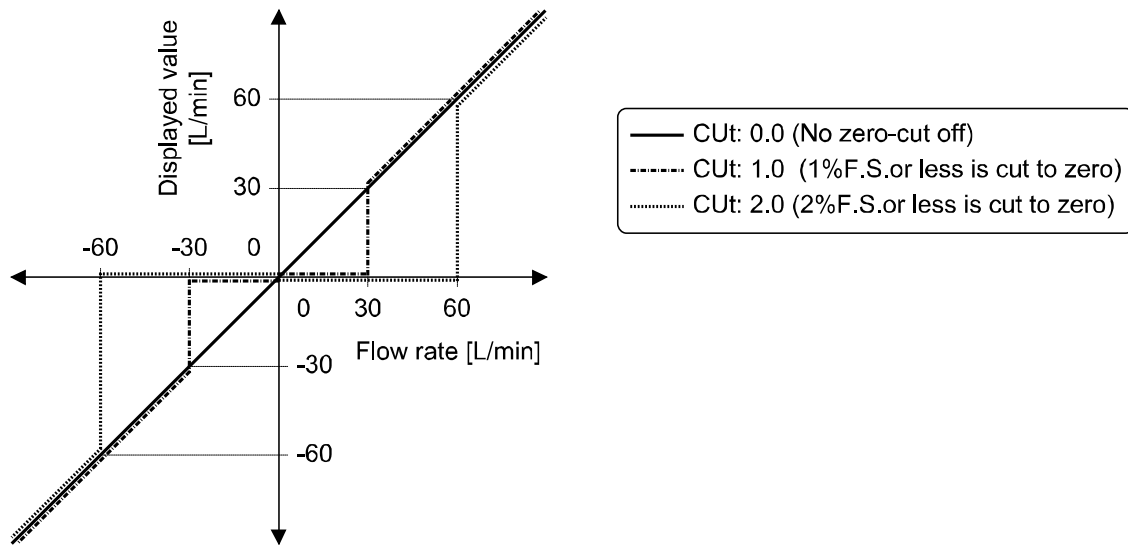

Press the  button to set.  Return to function selection mode.

[F14] Display with zero cut-off setting completed

*: Zero-cut range of the accumulated value and accumulated pulse should be 1%F.S. or more. However, please note that if the zero-cut setting value is 0.0, any value below 1%F.S. will be cut to zero.

*: When setting the flow value and hysteresis within the zero cut-off settable range, the on-off point varies depending on the settable range.

For further details, refer to "When the switch output (OUT) and hysteresis are set within Zero cut-off range (page 51).

*: In the minus (-) direction, down to -5% F.S. is the range for zero-cut off. [LLL] is displayed when the range is exceeded.

- When the set value and hysteresis of the switch output (OUT) is set within the zero-cut range. The operating point of the switch output will be changed, depending on the zero-cut setting value. However, please note that the set value and hysteresis of the switch output will not be changed. To maintain the on-off point, set the value and hysteresis without the zero cut-off range.

<Example: Flow range 3000 L/min>

Common setting

Output mode	Hysteresis mode
Switch operation	Normal output
Set value (P)	80
Hysteresis (H)	30

Initial setting

Zero cut-off setting CUT: 1.0 (displays 0 for a value below 30 L/min)

Switch ON point	80 L/min or more
Switch OFF point	Below 50 L/min

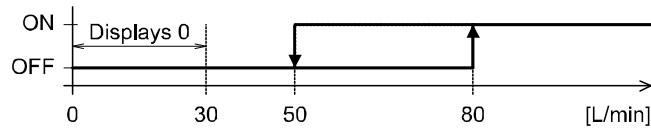

↓ Change the zero cut-off setting.
The set value (P) and hysteresis (H) cannot be changed.

~Condition when the operating point of hysteresis(H) is changed~

- The zero-cut setting CUT: 1.0 will be changed to CUT: 2.0. (0 will be displayed for a value below 60 L/min)

Switch ON point	80 L/min or more
Switch OFF point	Below 60 L/min (0 is displayed)

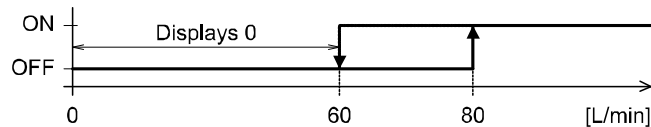

~Condition when the operating point of the set point (p) and hysteresis (H) is changed~

- The zero-cut setting CUT: 1.0 will be changed to CUT: 3.0. (0 will be displayed for a value below 90 L/min)

Switch ON point	90 L/min or more
Switch OFF point	Below 90 L/min (0 is displayed)

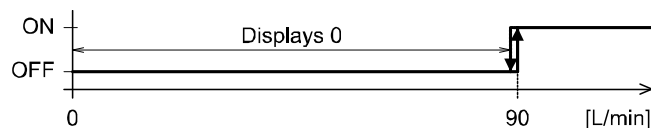

■[F30] Accumulated value hold setting

This function enables the accumulated flow value to be stored in permanent memory every 2 or 5 minutes. In the default setting, the accumulated flow value is not held when the power supply is turned off.

*: When using the accumulated value hold function, calculate the product life from the operating conditions, and use the product within its life.



Maximum updating time of the accumulated value is 1.5 million times.



If the product is operated 24 hours per day, the product life will be as follows:

- Data memorized every 5 minutes --- 5 minutes x 1.5 million times = 7.5 million minutes = 14.3 years
- Data memorized every 2 minutes --- 2 minutes x 1.5 million times = 3 million minutes = 5.7 years



If the accumulated flow external reset is also repeatedly used, the product life will be shorter.

<Operation>

Press the  or  button in function selection mode to display [F30].

Press the  button.  Move on to accumulated value hold setting.

Accumulated value hold setting

Press the  or  button to select the storage cycle of the accumulated value.



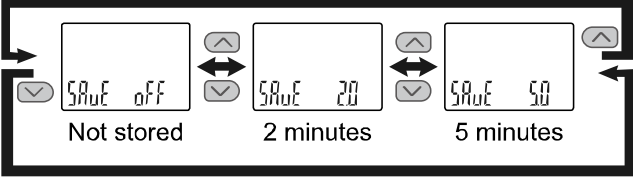

Press the  button to set.  Return to function selection mode.

[F30] Accumulated value hold setting completed

*: The value is stored in memory every 2 or 5 minutes. If the power supply is turned off, the accumulated flow since the last time it was stored will be lost.

*: When the power supply is turned on again, the accumulated flow count will start from the last value recorded at B.

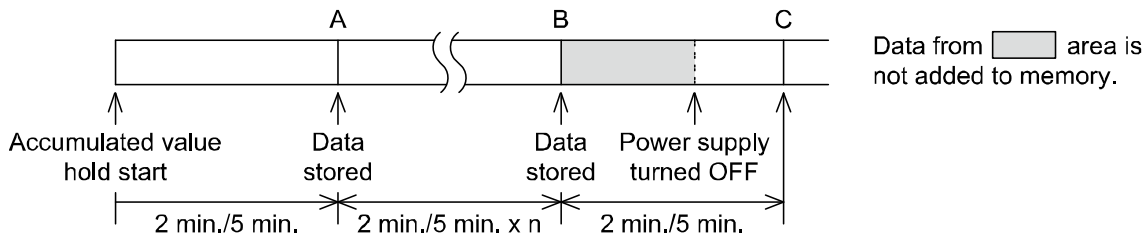





■[F80] Power saving mode

Power saving mode can be selected.



When selected, if no buttons are pressed for 30 seconds, the product will shift to power saving mode.

<Operation>

Press the  or  button in function selection mode to display [F80].

Press the  button.  Move on to power saving mode.

Power saving mode

Press the  or  button to select the power saving mode.

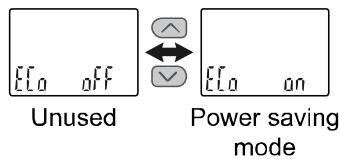

Press the  button to set.  Return to function selection mode.

[F80] Power saving mode completed

In power saving mode, when buttons are pressed the display is normal, but if no buttons are pressed for 30 seconds, it will revert to power saving mode (Power saving is only available in measurement mode).

During power saving mode, [ECo] will flash in the sub display and the operation LED is ON (when the switch is ON).

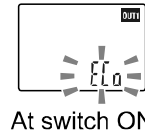

At switch ON





At switch OFF

*: There may be a difference in the displayed value between the connected flow switch and the flow monitor.
When the flow switch display is used, it is recommended to set the flow switch display OFF mode.

■[F81] Security code



The security code can be turned on or off and the security code can be changed when unlocked.

<Operation>

Press the  or  button in function selection mode to display [F81].

Press the  button.  Move on to security code.

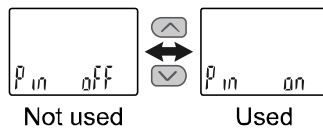

Security code

Press the  or  button to select the setting of security code.



Press the  button to set.  Move on to security code checking.

Security code checking

Press the  or  button to input the security code on the sub display (right).
(The default setting is [000].)*



For instructions on how to enter the security code, refer to "How to input and change the security code" on page 68.

If the security code entered is incorrect, [FAL] will be displayed, and the security code must be entered again.



If an incorrect security code is entered 3 times, [nG] will be displayed and the device will return to function selection mode.

[oFF] (not used) is selected.



Press the  button to return to function selection mode.

Press the  button for 1 second to set.  Move on to changing the security code.



Changing the security code

Press the  or  button to enter the changed security code on the main display. *
For instructions on how to enter the security code, refer to "How to input and change the security code" on page 68.

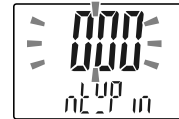

After entry, the new security code will flash by pressing the  button for 1 second (At this point, the changing of the security code is not completed).
Return to the change of setting again by pressing the  or  button.



Press the  button for 1 second to set.  Return to function selection mode.

[F81] Security code completed



If the security code function is enabled, it will be necessary to enter a security code to release the key-lock.

*: If a key is not pressed for 30 seconds while entering the security code, function selection mode will return.

■[F90] Setting of all functions

All functions can be set in turn.



<Operation>

Press the  or  button in function selection mode to display [F90].

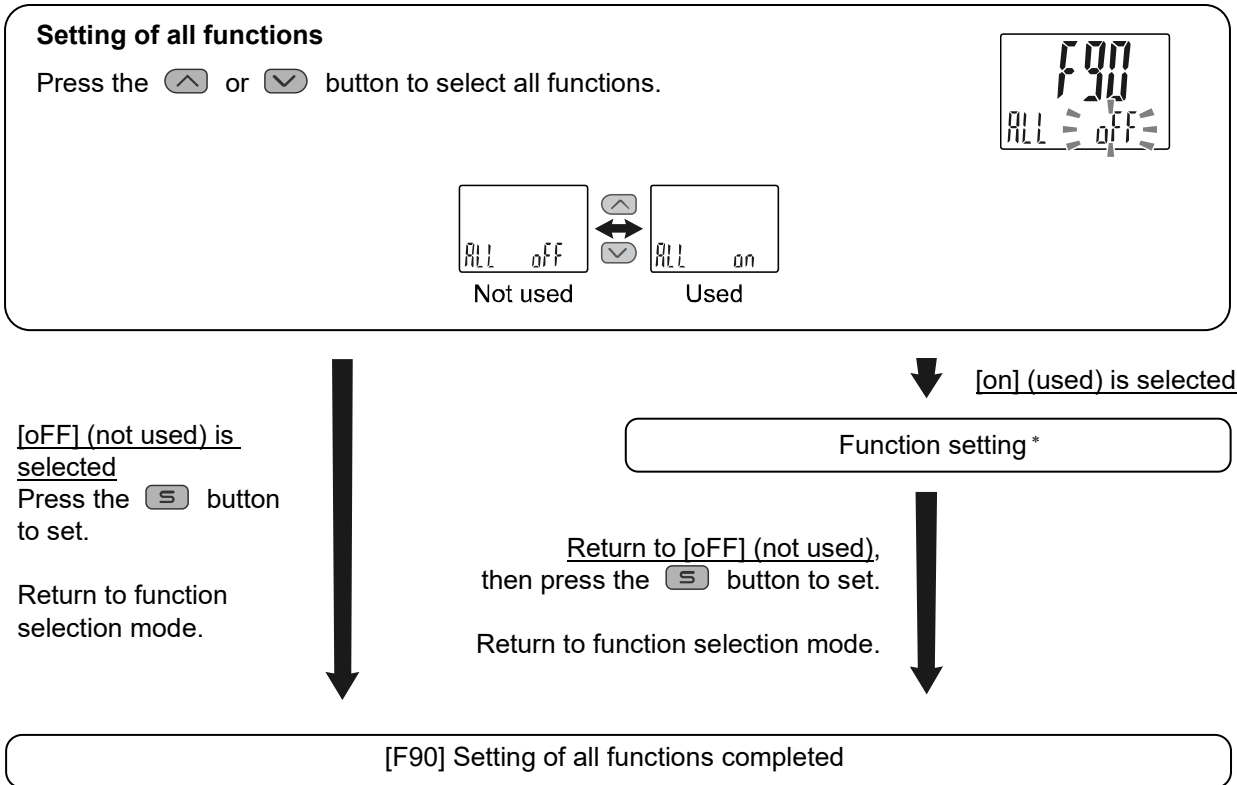
Press the  button.  Move on to setting of all functions.



*: Setting of each function

Every time the  button is pressed, the display moves to the next function in order of "Setting of each function" on page 57. Set by using the  and  buttons.

For details of how to set each function, refer to the relevant section in this manual.

*: Measurement mode can be returned from any setting items by pressing and holding the  button for 2 seconds or longer.

*: The function setting from before returning to the measurement mode will be maintained.

●Setting of each function

Order	Function
1	Flow range setting
2	Display unit setting
3	Switching setting of switch output NPN/PNP specifications
4	Output mode setting of OUT1
5	Reversed output setting of OUT1
6	Flow setting of OUT1
7	Hysteresis setting of OUT1
8	Delay time setting of OUT1
9	Display colour setting
10	Output mode setting of OUT2
11	Reversed output setting of OUT2
12	Flow setting of OUT2
13	Hysteresis setting of OUT2
14	Delay time setting of OUT2
15	Display colour setting
16	Digital filter setting
17	FUNC terminal function setting
18	Sub display setting
19	Display with zero cut-off setting
20	Accumulated value hold setting
21	Power saving mode
22	Security code

*: Measurement mode can be returned from any setting item by pressing the  button for 2 seconds or longer.



*: Functions set before returning to the measurement mode are maintained.



*: Only the corresponding settings are displayed.

■[F96] Sensor input/External input signal status display

The sensor input signal (1 to 5 V or 4 to 20 mA) and the external input signal can be checked.

<Operation>

Press the  or  button in function selection mode to display [F96].

Press the  button.  Move on to sensor input/external input signal status display.

Sensor input/External input signal status display

Select to display the sensor input or external input signal condition by pressing the  button.

*: Only the sensor input can be displayed if the external input signal [F 5] is not set.

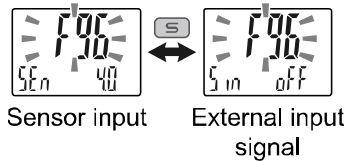

■[F97] Copy setting

The set values can be copied. When the input specification, output specification and the units specification are the same, this function is available.

The set value can be copied to up to 10 flow monitors simultaneously.

<Connection>

Connect the flow monitors together with the power supply turned off.

Connect the FUNC terminals of the copy source flow monitor and the copy destination flow monitors, and then turn on the power supply.

The copy source flow monitor is the monitor from which the setting is to be copied.

The copy destination flow monitor is the monitor to which the setting is to be copied.

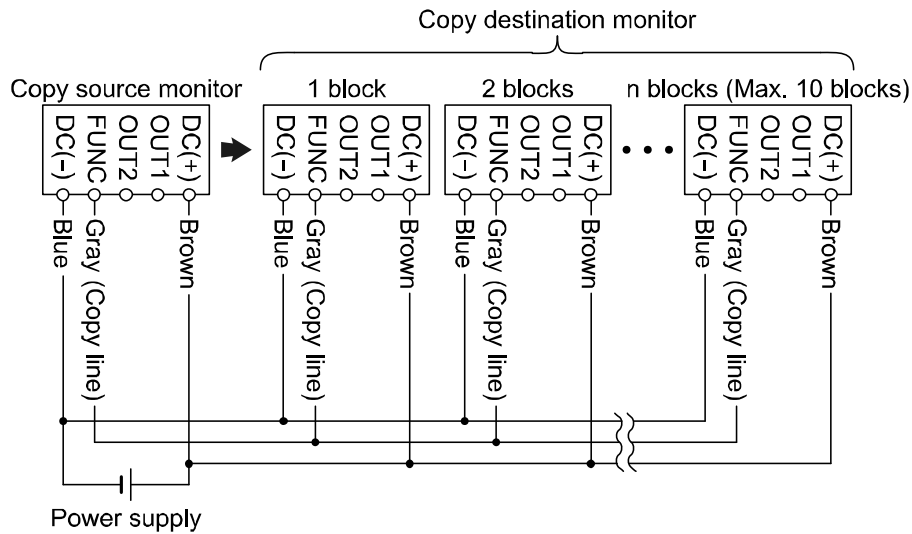

<Operation>

Press the or button of the copy source flow monitor in function selection mode to display [F97].

Press the button. Move on to copy setting.

Copy setting

Press the or button to select the copy function.

[onL]: Copy destination is key-locked after copying

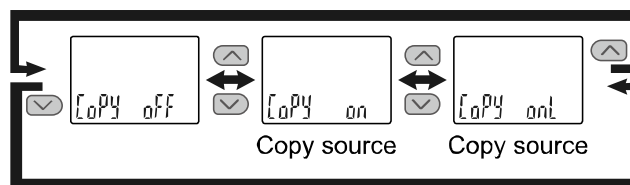

When [on] [onL] (Copy source) is selected
Press the button to move to the screen to start copying.

[oFF] (not used) is selected.
Press the button to set.

Return to function selection mode.

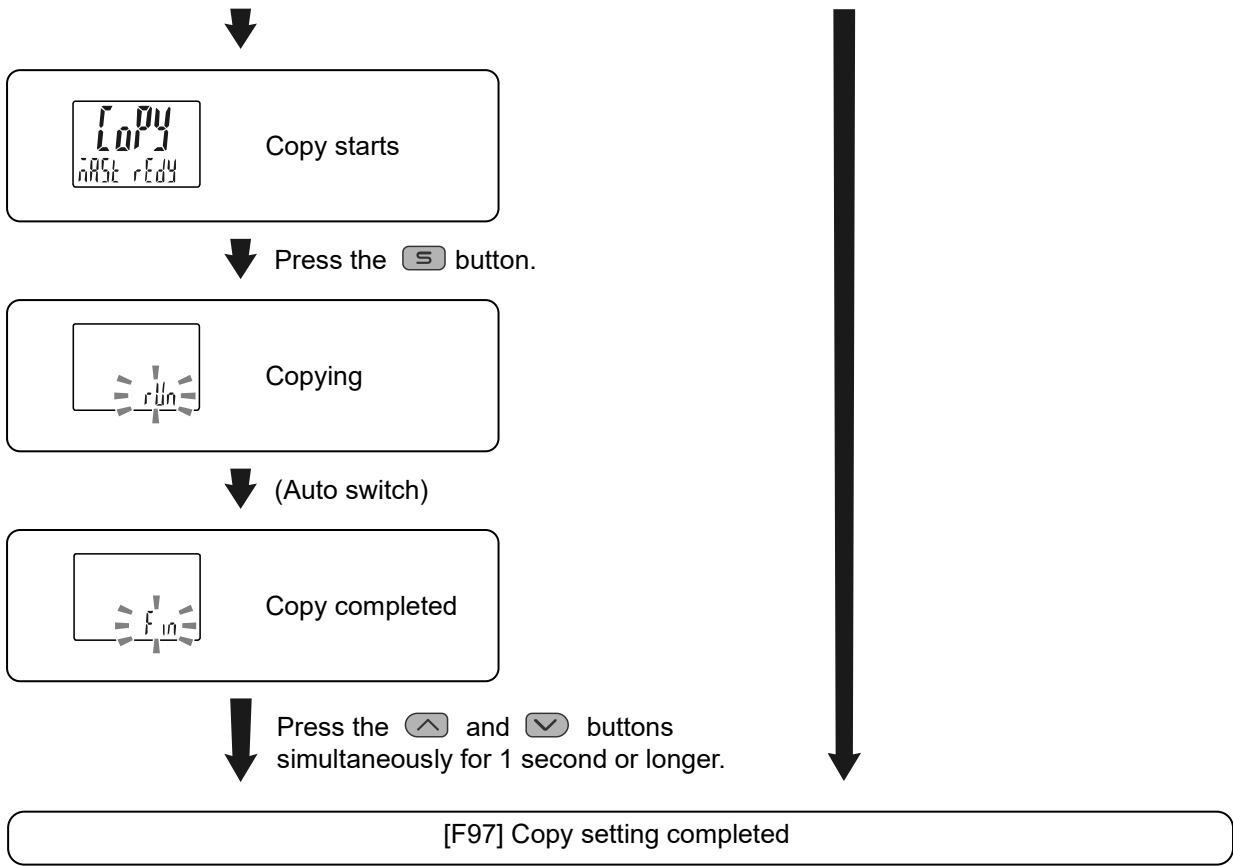

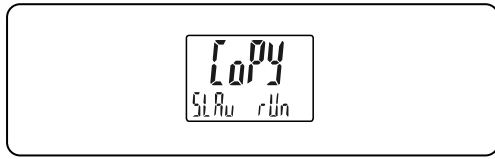

After selecting the copy source, all other connected monitors switch to copy destination.

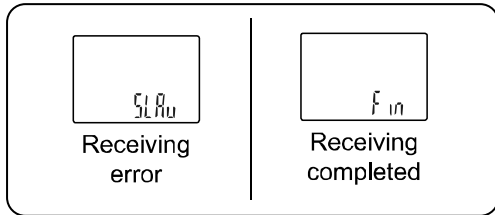

↓ (Auto switch)





↓ Press the  and  buttons simultaneously for 1 second or longer.

End

■[F98] Output check



The switch output or analogue output can be selected for an output check.
The output can be turned ON/OFF manually for checking.



<Operation>

Press the  or  button in function selection mode to display [F98].

Press the  button.  Move on to output check.

Output check

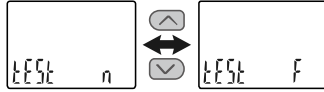
Press the  or  button to select output check.



Normal output
(Output not checked)

Forced output
(Output is checked)



When [n]
(Normal output)
is selected.
Press the
 button
to set.



Return to
function
selection mode.

When [F] (Forced output) is
selected.

Press the  button to set.

OUT1 output check

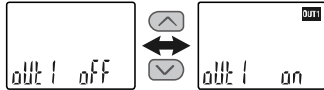
Press the  or  button to select OUT1
output check.



Forced output
OFF

Forced output
ON

Press the  button to set. 

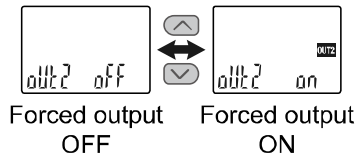

OUT2 output check

Press the  or  button to select OUT2 output check.





When switching of analogue output is selected for the setting of [F 5] FUNC terminal function
Press the  button to move on to FUNC terminal function setting.

FUNC terminal function setting

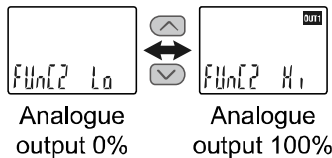
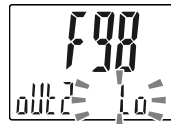
Press the  or  button to select the analogue output.



When external input or copy function is selected for the setting of [F 5] FUNC terminal function.
Press the  button to set.
Return to function selection mode.

Press the  button to return to [n] (normal output), then press the  button to set.

Return to function selection mode.



[F98] Output check completed



*: Measurement mode can be returned from any setting by pressing the  button for 2 seconds or longer.

■[F99] Reset to default settings





If the product settings have become uncertain, the default values can be restored.

<Operation>

Press the  or  button in function selection mode to display [F99].

Press the  button.  Move on to reset to default settings.

Reset to default settings

Press the  or  button to display [ON], then press the  and  buttons simultaneously for 5 seconds or longer.

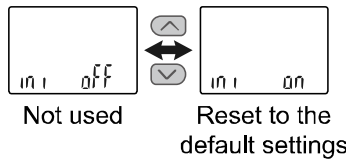

[oFF] (not used) is selected.
Press the  button to set.

Return to function selection mode.

All settings are returned to the default values.



Return to function selection mode.

[F99] Reset to default settings completed

Other Settings

○ Snap shot function

The current flow value can be stored to the switch output ON/OFF set point.

When the items of sub display (left) below are selected in 3 step setting mode, simple setting mode or function selection mode ([F 1] Setting of OUT1, [F 2] Setting of OUT2), by pressing the  and  buttons simultaneously for 1 second or longer, the value of the sub display (right) shows [- -], and the values corresponding to the current flow values are automatically displayed.

Output mode	Configurable items	Sub display (left)	Snap shot function
Hysteresis mode	Set value	$P_{-1} (n_{-1}) / P_{-2} (n_{-2})$	○
	Hysteresis	H_{-1} / H_{-2}	○
Window comparator mode	Set value	$P_{1L} (n_{1L}), P_{1H} (n_{1H}) / P_{2L} (n_{2L}), P_{2H} (n_{2H})$	○
	Hysteresis	H_{11} / H_{12}	×
Accumulated output mode	Set value	P_1, P_2, n_1, n_2	×

• Set value

The value is set to the same value as the display value (current flow value).



(There is a range which cannot be set to the current flow depending on the hysteresis. In that case, the value is set to the closest value.)

• Hysteresis

The hysteresis is calculated from the equation below and set.

Normal output: (set value) - (current flow value)
Reverse output: (current flow value) - (set value)



If the calculation result becomes 0 or less, [Err] is displayed on the sub display (right) and the set value is not changed.

Afterwards, it is possible to adjust the value by pressing the  or  button.

○ Peak/bottom value indication

The maximum (minimum) flow when the power is supplied is detected and updated.



In peak/bottom indication mode, the current flow is displayed.

Press the  or  button in measurement mode to switch the sub-display (left) to the display shown below.

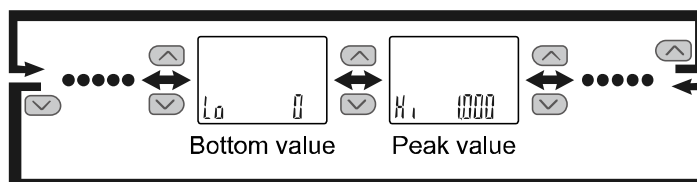
Peak/bottom values are displayed on the sub display (right) at the same time as the current flow value on the main display.



○ Reset

When the  and  buttons are pressed for 1 second or longer simultaneously while the accumulated flow/peak/bottom values are displayed, the sub display (right) displays [---] and the display values are cleared.

○Key-lock function

The key-lock function is used to prevent errors occurring due to unintentional changes of the set values. If the **[S]** button is pressed while the keys are locked, [LoC] is displayed on the sub display (right) for approximately 1 second.

(Each setting and peak/bottom values are displayed with **[^]** and **[v]** buttons.)

<Operation - Without security code input ->

- (1) Press the **[S]** button for 5 seconds or longer in measurement mode. When [oPE] is displayed on the main display, release the button.

The current setting [LoC] or [UnLoC] will be displayed on the sub display.

(To release key-lock repeat the above operation.)



- (2) Select the key-locking/un-locking with **[^]** or **[v]** button, and press the **[S]** button to set.

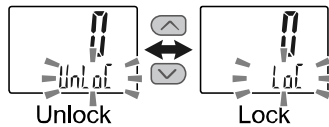

<Operation – With security code input ->

•Locking

- (1) Press the **[S]** button for 5 seconds or longer in measurement mode. When [oPE] is displayed on the main display, release the button.

The current setting [LoC] or [UnLoC] will be displayed on the sub display.

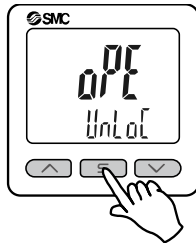

- (2) Select the key [LoC] with **[↑]** or **[↓]** button, and press the **[S]** button to set.

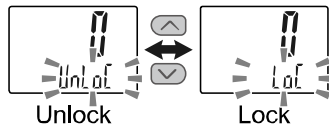

•Unlocking

- (1) Press the **[S]** button for 5 seconds or longer in measurement mode. When [oPE] is displayed on the main display, release the button.

The current setting [LoC] or [UnLoC] will be displayed on the sub display.

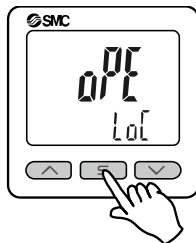

- (2) Select [UnLoC] to unlock with the **[↑]** or **[↓]** button. Setting is recognized by pressing the **[S]** button, then the security code is required.

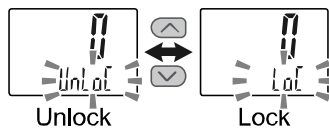

- (3) For instructions on how to enter the security code, refer to "How to input and change the security code" on page 68.

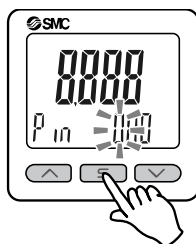



- (4) If the security code entered is correct, the main display will change to [UnLoC], and pressing one of **[↑]**, **[S]** or **[↓]** button releases the key-lock and the measurement mode returns.
If the security code entered is incorrect, [FAL] will be displayed, and the security code must be entered again. If an incorrect security code is entered 3 times, [LoC] is displayed and the device returns to measurement mode.

● **How to input and change the security code**

The left most digit starts flashing.

Press the  or  button to select a value.

Press the  button to make the next digit to the right flash.

(If the  button is pressed at the last digit, the first digit will start flashing).

After the setting is complete, Press and hold the  button for 1 second or longer.

(If an operation is not performed for 30 seconds during input or change of the security code, the product will return to measurement mode).

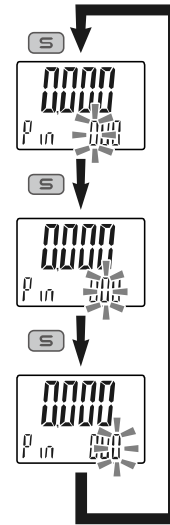

Maintenance

How to reset the product after a power cut or forcible de-energizing

The setting of the product will be retained as it was before a power cut or de-energizing. The output condition is also basically recovered to that before a power cut or de-energizing, but may change depending on the operating environment. Therefore, check the safety of the whole installation before operating the product. If the installation is using accurate control, wait until the product has warmed up (approximately 10 to 15 minutes).

Forgotten security code

If you have forgotten your security code, please contact SMC directly.

Troubleshooting

○Troubleshooting

When any failure occurs with this product, the following chart can be used to identify the cause of the failure. If a cause applicable to the troubles cannot be identified and normal operation is recovered by replacement with a new product, this indicates that the product itself was faulty. Problems with the product may be due to the operating environment (installation etc). Please consult SMC.

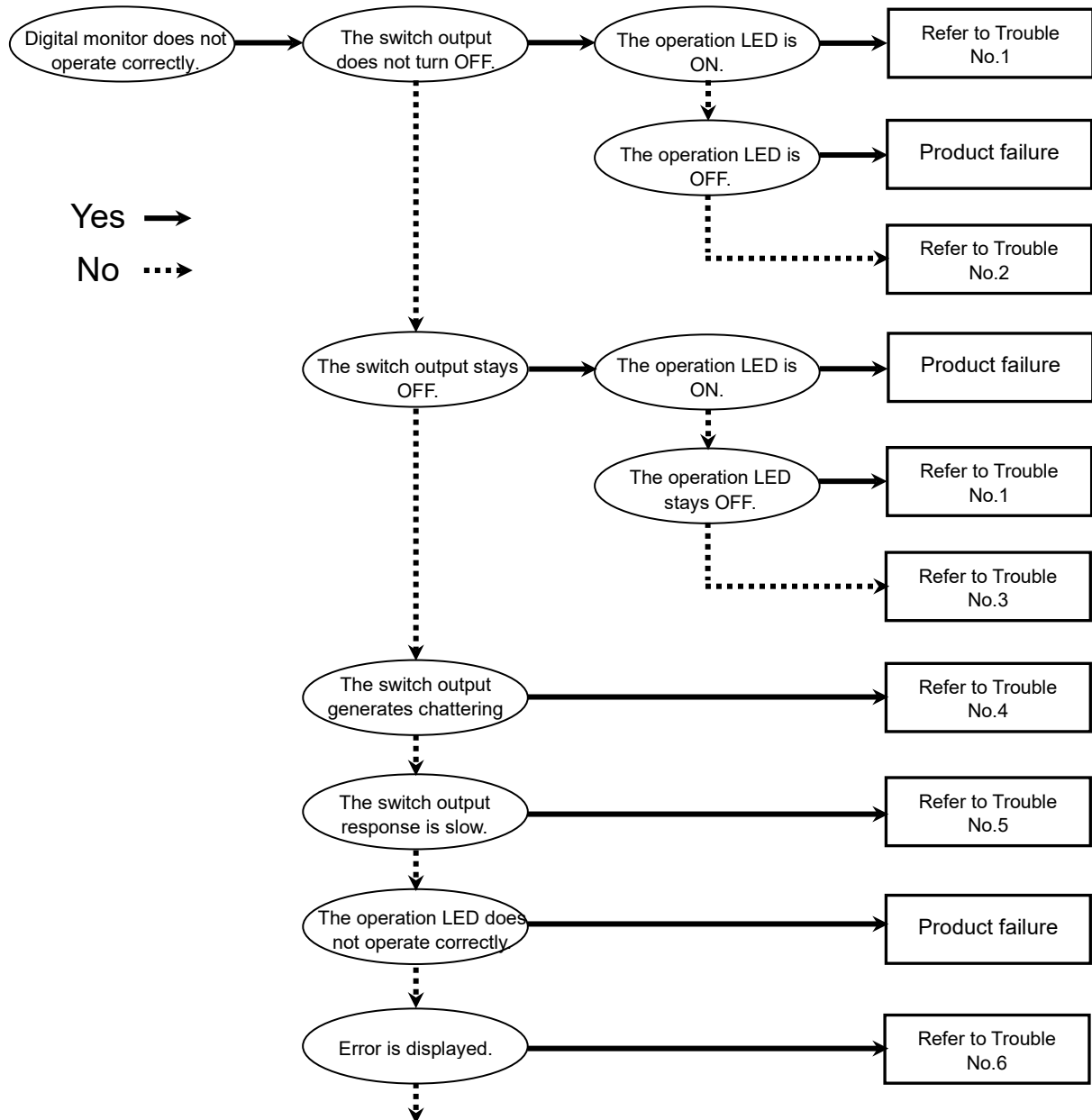

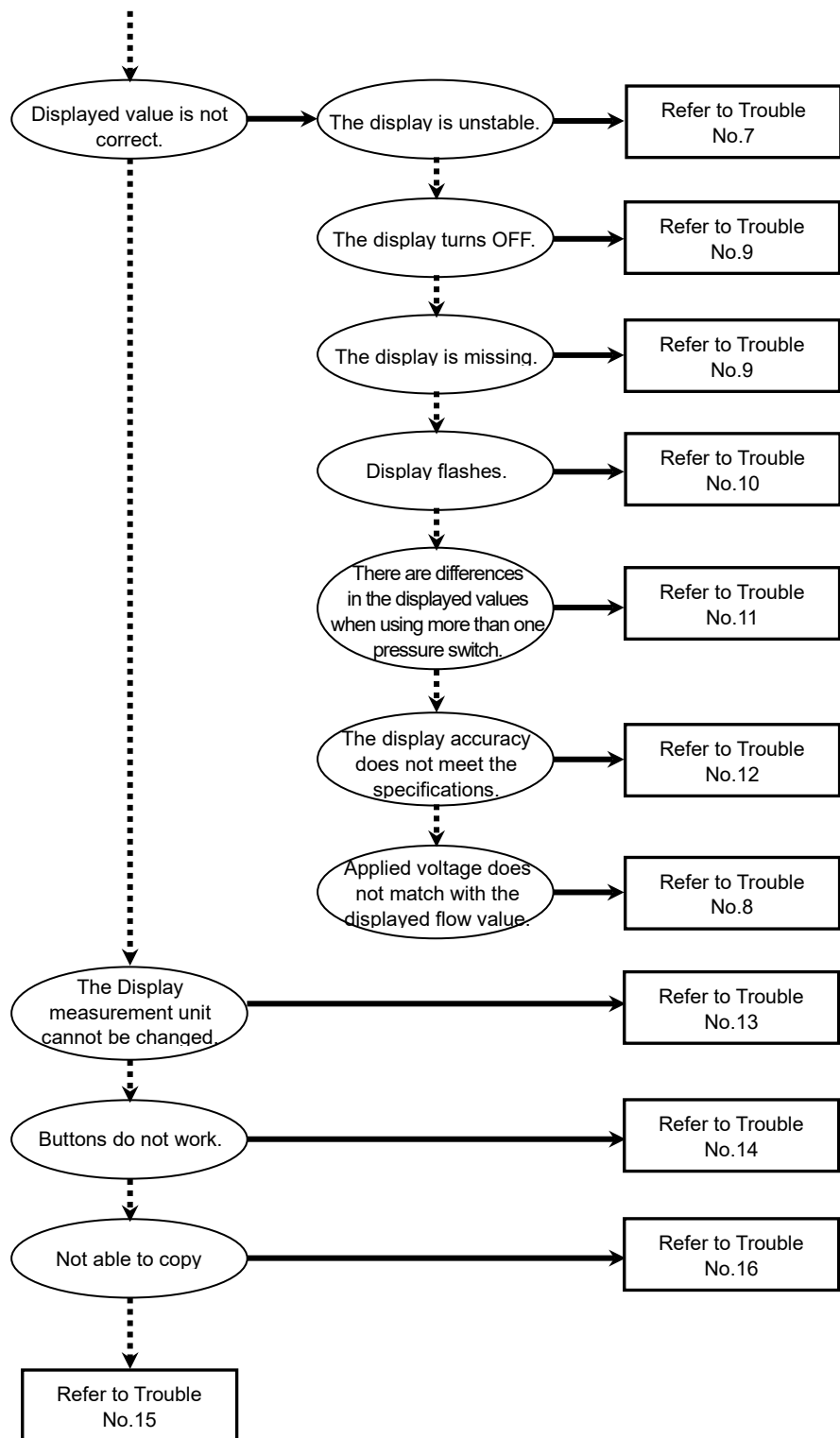

○Troubleshooting

Problem No.	Problem	Possible cause	Investigation method	Countermeasures
1	<ul style="list-style-type: none"> •The switch output does not turn OFF. The operation LED stays ON. •The switch output does not turn ON. The operation LED stays OFF. 	Incorrect flow setting	(1) Check the set flow value. (2) Check the settings of the operation mode, hysteresis and output type. (Hysteresis mode/Window comparator mode/Accumulated output mode/Accumulated pulse mode/Error detection mode/Output OFF mode, normal output/reversed output can be selected)	(1) Adjust the set flow value. (2) Set the operation mode, hysteresis and output type again.
		Product failure		Replace the product.
2	The switch output does not turn OFF. The operation LED is normal.	Incorrect wiring	Check the output wiring. Check if the load is directly connected to DC(+) or DC(-).	Check and correct the wiring.
		Product failure		Replace the product.
3	The switch output is OFF. The operation LED is normal.	Incorrect wiring	Check the output wiring. Check if the load is directly connected to DC(+) or DC(-).	Check and correct the wiring.
		Incorrect SW output specification setting	Check the SW output specification setting. Check if the SW output is PNP while NPN is intended to be set, and vice versa.	Set the SW output specification again.
		Lead wire broken	Check if there is bending stress applied to any part of the lead wire. (bending radius, tensile force to the lead wire)	Correct the wiring. (Reduce the tensile force or increase the bending radius.)
		Product failure		Replace the product.
4	The switch output generates chattering.	Incorrect wiring	Check the wiring. Check if the brown and blue wires are connected to DC(+) and DC(-) respectively, and if the output line is secure (contact failure).	Correct the connection on the power cord and the plug.
		Incorrect flow setting	(1) Check the set flow value. (2) Check if the hysteresis range is small. (3) Check the delay time setting. Check if the delay time is too short.	(1) Adjust the set flow value. (2) Make the hysteresis wider. (3) Set the delay time again.
		Product failure		Replace the product.
5	The switch output response is slow.	Delay setting time is too long	Check if the time set for delay or digital filter is too long.	Reset the set value for delay time or digital filter.







Problem No.	Problem	Possible cause	Investigation method	Countermeasures
6	<ul style="list-style-type: none"> •Over current error (Er1,2) is displayed. •COPY receiving error (Er13) is displayed. •System error (Er0, 4, 6, 7, 8, 14,40) is displayed. •"HHH" is displayed. •"LLL" is displayed. 	Excess current was applied to the output (Er1,2)	<ol style="list-style-type: none"> (1) Check if the output current is 20 mA or more. (2) Check if the connected load complies with the specification. Check if the load is short circuited. (3) Check if the relay without surge protection is connected. (4) Check if the wiring is in the same route as (or bundled together with) a high-voltage or power line. 	<ol style="list-style-type: none"> (1)(2) Connect the appropriate load. (3) Use a relay with a surge voltage suppressor or take measures to prevent surge. (4) Separate the wiring from the high-voltage and/or power line.
		Copy function operated incorrectly (Er13)	Check the wiring. Check if the brown and blue wires are connected to DC(+) and DC(-) respectively and the grey wires to each monitor are connected, and that the wiring is secure.	Correct the wiring.
		Incorrect internal data processing of the product (Er0,4,6,7,8,14,40)	<ol style="list-style-type: none"> (1) Check if there is noise interference (such as static electricity). Check if there is a noise source nearby. (2) Check if the power supply voltage is in the range 12 to 24 VDC $\pm 10\%$. 	<ol style="list-style-type: none"> (1) Remove the noise and the noise source (or take measures to prevent noise interference), and reset the product (or turn off and then turn back on the power supply). (2) Supply power in the range 12 to 24 VDC $\pm 10\%$.
		Applied flow is higher than the upper limit (HHH)	<ol style="list-style-type: none"> (1) Check if the flow exceeds the upper limit of the set flow range. (2) Check if foreign matter has entered the piping. 	<ol style="list-style-type: none"> (1) Reset applied flow to a level within the set flow range. (2) Take measures to prevent foreign matter from entering the piping.
		Applied flow is lower than the lower limit (LLL)	<ol style="list-style-type: none"> (1) Check if the flow exceeds the lower limit of the set flow range. (2) Check if foreign matter has entered the piping. 	<ol style="list-style-type: none"> (1) Reset applied flow to a level within the set flow range. (2) Take measures to prevent foreign matter from entering the piping.
		Product failure		Replace the product.
		7	The display is unstable.	Incorrect power supply
Incorrect wiring	Check the power supply wiring. Check if the brown and blue wires are connected to DC(+) and DC(-) respectively, and if the wiring is secure.			Check and correct the wiring.
Factory line pressure is not stable	Check if the factory line flow is stable.			Improve the display stability by setting the delay time or digital filter.



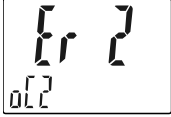

Problem No.	Problem	Possible cause	Investigation method	Countermeasures
8	Applied voltage does not match with the displayed pressure value.	Incorrect flow range setting	Check the flow range setting. Check if the connected flow sensor and the set flow range are correct.	Select the correct flow range.
9	<ul style="list-style-type: none"> •The display turns OFF. •Part of the display is missing. 	Incorrect power supply	Check if the power supply voltage is in the range 12 to 24 VDC \pm 10%.	Supply power in the range 12 to 24 VDC \pm 10%.
		Incorrect wiring	Check the power supply wiring. Check if the brown and blue wires are connected to DC(+) and DC(-) respectively, and if the wiring is secure.	Check and correct the wiring.
		Power saving mode	Check if power saving mode is selected.	Select the power saving mode again.
		Product failure		Replace the product.
10	Display flashes.	Incorrect wiring	(1) Check the power supply wiring. (2) Check if there is bending stress applied to any part of the lead wire.	(1) Check and correct the wiring. (2) Correct the wiring (bend radius and stress).
		Display flashes 999.999	Accumulated flow rate has exceeded the upper limit of the display.	Reset the accumulated flow.
11	Flow rate of the connected flow sensor and flow display is inconsistent.	Variation within the display accuracy range	Check if the variation is within the display accuracy range.	If the display accuracy is within the range, set one of the displays to OFF mode (power saving mode).
		Product failure		Replace the product.
12	The flow rate display accuracy does not meet the specifications.	Warming up inadequate	Check if the product satisfies the specified accuracy 10 minutes after supplying power.	After energizing, the display and output can drift. If using the product to detect very small flow differences, warm up the product for 10 to 15 minutes before use.
		Product failure		Replace the product.

Problem No.	Problem	Possible cause	Investigation method	Countermeasures
13	Display measurement units cannot be changed.	Model selection (the model selected does not have the units selection function)	Check if the product number printed on the product indicates a type with units selection function.	Units selection function is not available for the fixed SI units type. *: The units selection function is not for use in Japan *: Fixed to SI units: L/min
		Product failure		Replace the product.
14	Buttons do not operate.	Key-lock mode is activated	Check if the key-lock function is turned on.	Check the key-lock function.
		Product failure		Replace the product.
15	The operation is unstable. (chattering)	Effect of line pressure fluctuation because hysteresis is too narrow or delay time of the switch is too short	(1) Check the set pressure values (hysteresis). (2) Check the delay time and digital filter set values.	(1) Adjust the set flow value. (2) Change the response time setting.
		Incorrect wiring/broken lead wire	(1) Check the power supply wiring. (2) Check if there is bending stress applied to any part of the lead wire. (bending radius, tensile force to the lead wire)	(1) Check and correct the wiring. (2) Correct the wiring. (Reduce the tensile force or increase the bending radius.)
		Product failure		Replace the product.
16	Not able to copy	Specifications are not consistent with the copy source.	Check if the input specification, output specification and unit specifications are consistent with the copy source monitor.	Use a product for which the specifications are the same as the copy source's specification.
		Product failure		Replace the product.

○Error indication function

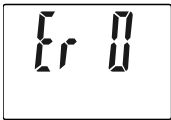
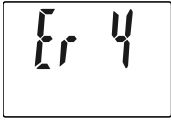
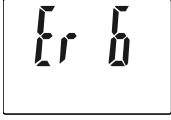
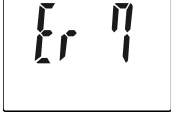
This function is to display error location and content when a problem or error has occurred.

Error	Error displayed	Description	Measures
Over current error	 	The switch output load current is 80 mA or more.	Turn the power off and remove the cause of the over current. Then supply the power again.
Flow error		Flow exceeding the upper limit of the set flow range is applied.	Reset applied flow to a level within the set flow range.
		Flow exceeding the lower limit of the set flow range is applied.	
Accumulated flow error	 	Accumulated flow rate has exceeded the upper limit of the display.	Reset the accumulated flow.
COPY receiving error		Communication is not complete.	After checking the wiring, retry copying.

Error	Error displayed	Description	Measures
System error		Displayed if an internal data error has occurred.	Turn the power off and on again. If the failure cannot be solved, contact SMC.
			
			
			
			
			
			

If the error cannot be reset after the above measures are taken, or errors other than above are displayed, please contact SMC.

Specifications

Model		PFG3#0							
Applicable SMC Flow Switch	Model	PFMB7201	PFMB7501 PFMC7501	PFMB7102 PFMC7102	PFMB7202 PFMC7202	PF3A703H	PF3A706H	PF3A712H	
	Rated flow range *1	2 to 200 L/min	5 to 500 L/min	10 to 1000 L/min	20 to 2000 L/min	30 to 3000 L/min	60 to 6000 L/min	120 to 12000 L/min	
Flow	Set flow rate range	Instantaneous flow	-10 to 210 L/min	-25 to 525 L/min	-50 to 1050 L/min	-100 to 2100 L/min	-150 to 3150 L/min	-300 to 6300 L/min	-600 to 12600 L/min
		Accumulated flow	0 to 999,999,999,999 L	0 to 999,999,999,990 L				0 to 999,999,999,900 L	
	Min. setting unit	Instantaneous flow	1 L/min			2 L/min	5 L/min	10 L/min	
		Accumulated flow	1 L	10 L			100 L		
	Accumulated volume per pulse (Pulse width = 50 msec.)		1 L/pulse		10 L/pulse		100 L/pulse		
	Accumulated value hold *3		Every 2 or 5 minutes, The stored accumulated flow is held even when the power supply is OFF.						
Electrical	Power supply voltage	DC12 to 24 V±10% (24 VDC when PF3A7 is connected)							
	Current consumption	25 mA or less							
	Protection	Polarity protection							
Accuracy	Display accuracy	±0.5%F.S. Min. display unit (at ambient temperature 25 °C constant temperature)							
	Analogue output accuracy	±0.5%F.S. (at ambient temperature 25 °C constant temperature)							
	Repeatability	±0.1%F.S. Min. display unit							
	Temperature characteristics	±0.5%F.S. (at ambient temperature 0 to 50 °C, 25 °C standard)							
Switch output	Output type	Select from NPN or PNP open collector output.							
	Output mode	Hysteresis mode, Window comparator mode, Accumulated output mode or Accumulated pulse output mode, Error output mode or switch output OFF mode.							
	Switch operation	Normal output or Reversed output							
	Max. load current	80 mA							
	Max. applied voltage (Only NPN)	30 VDC							
	Internal voltage drop (Residual voltage)	NPN output: 1.0 V or less (at 80 mA), PNP output: 1.5 V or less (at 80 mA)							
	Response time *2	3 ms or less							
	Delay time *2	Select from 0, 0.05 to 0.10 sec. (increment of 0.01 sec.), 0.1 to 1.0 sec. (increment of 0.1 sec.), 1 to 10 sec. (increment of 1 sec.), 20 sec., 30 sec., 40 sec., 50 sec. and 60 sec.							
	Hysteresis *4	Variable							
	Protection	Short circuit protection							
Analogue output *5	Output type	Voltage input: 1 to 5 VDC, 0 to 10 VDC (only when the power supply voltage is 24 VDC) *6 Current input: 4 to 20 mA (0 L/min to max. value of the rated flow)							
	Impedance	Voltage output	Output impedance approx.: 1 kΩ						
		Current output	Max. load impedance: 300 Ω at 12 VDC, 600 Ω at 24 VDC						
	Response time *2	50 ms or less							

Model		PFG3#0								
External input ^{*7}	External input specification	Input voltage: 0.4 V or less (reed or solid state type), Input time: 30 msec. or longer								
	Input mode	Accumulated flow external reset or peak/bottom hold value								
Sensor input	Input type	Voltage input: 1 to 5 VDC (Input impedance: 1 MΩ) Current input: 4 to 20 mA (Input impedance: 51 Ω) (0 L/min to max. value of the rated flow)								
	Connection method	Connector (e-con)								
	Protection	Over voltage protection (up to 26.4 V)								
Display	Display mode	Select from Instantaneous flow or Accumulated flow.								
	Unit ^{*8}	Instantaneous flow	L/min, cfm (ft ³ /min)							
		Accumulated flow	L, ft ³ , L×10 ⁶ , ft ³ ×10 ⁶							
	Displayable range	Instantaneous flow	-10 to 210 L/min	-25 to 525 L/min	-50 to 1050 L/min	-100 to 2100 L/min	-150 to 3150 L/min	-300 to 6300 L/min	-600 to 12600 L/min	
		Accumulated flow ^{*10}	0 to 999,999,999,999 L	0 to 999,999,999,990 L					0 to 999,999,999,900 L	
	Min. setting unit	Instantaneous flow	1 L/min			2 L/min		5 L/min	10 L/min	
		Accumulated flow	1 L	10 L				100 L		
	Display type	LCD								
	Number of displays	3-screen display (Main display, sub display)								
	Display colour	1) Main display: Red/Green 2) Sub display: Orange								
	Number of display digits	1) Main display: 5 digit (7-segments) 2) Sub display: 9 digit (7-segments)								
Indicator LED	LED is ON when switch output is ON (OUT1/OUT2: Orange)									
Digital filter ^{*9}	Select from 0, 0.05 to 0.10 sec. (increment of 0.01 sec.), 0.1 to 1.0 sec. (increment of 0.1 sec.), 1 to 10 sec. (increment of 1 sec.), 20 sec., 30 sec.									
Environmental	Enclosure rating	IP40								
	Withstand voltage	1000 VAC, for 1 minute between live parts and case								
	Insulation resistance	50 MΩ or more between live parts and case (with 500 VDC megger)								
	Operating temperature range	Operation: 0 to 50 °C, Storage: -10 to 60 °C (No condensation or freezing)								
	Operating humidity range	Operation, Storage: 35 to 85%RH (no condensation or freezing)								
Standards	CE/UKCA marked									
Weight	Body	25 g (without lead wire)								
	Lead wire with connector	+39 g								

*1: Rated flow range of the applicable flow switch.

*2: Value without digital filter (at 0 ms).

*3: When using the accumulated value hold function, calculate the product life from the operating conditions, and use the product within its life.
The maximum access limit of the memory device is 1.5 million cycles. If the product is operated 24 hours per day, the product life will be as follows.

*5 min. cycle: 5 min. × 1.5 million times = 7.5 million min. = 14.3 years/2 min. cycle: 2 min. × 1.5 million times = 3 million min. = 5.7 years
If the Accumulated flow external reset is repeatedly used, the product life will be shorter than the calculated life.

*4: If the applied voltage fluctuates around the set value, the hysteresis width must be greater than the fluctuation width. Otherwise, chattering will occur.

*5: This function is available only for models with analogue output.

*6: When selecting 0 to 10 V, refer to the analogue output graph for the allowable load current.

*7: This function is available only for models with external input.

*8: Setting is possible only for models with the units selection function.

*9: The response time indicates when the set value is 90% in relation to the step input.

*10: The first and next 6 digits (12 digits in total) for accumulated flow rate are displayed. When the first 6 digits are displayed, [x 10⁶] is displayed.

*11: Any products with tiny scratches, smears, or variations in the display colour or brightness, which does not affect the performance of the product, are verified as conforming products.

■ Characteristics data

● Flow rate/Analogue output

	A	B *2	C
Voltage output (1 to 5 V)	1 V	1.04 V	5 V
Current output (4 to 20 mA)	4 mA	4.16 mA	20 mA

	E	F	G
Voltage output (0 to 10 V) *1	0 V	0.10 V	10 V

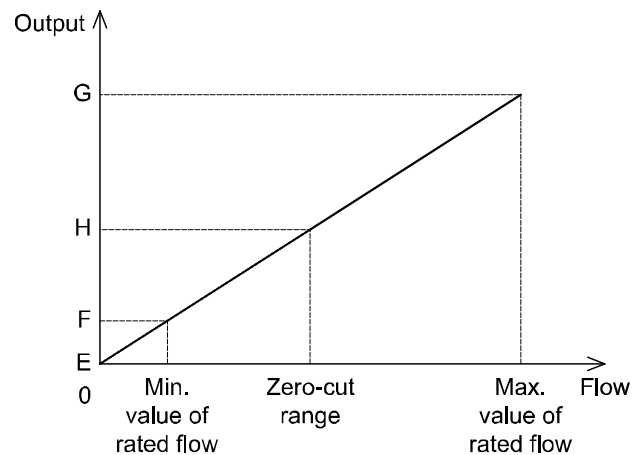
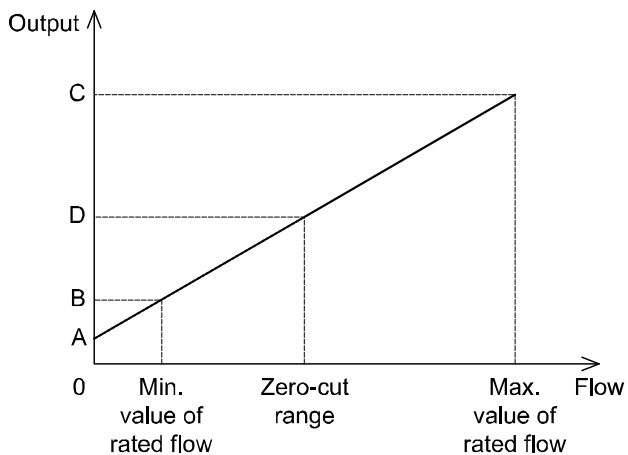

*1: The analogue output current from the connected equipment should be 20 μ A or less when selecting 0 to 10 V.

When more than 20 μ A current flows, it is possible that the accuracy will not be satisfied below 0.5 V.

*2: D or H changes based on the setting of the zero cut-off function.

When the zero cut-off function is set to "0", the display starts from 0 L/min. In conditions other than horizontal installation and 0.35 MPa supply pressure, the output may not be 0 L/min.

■Dimensions

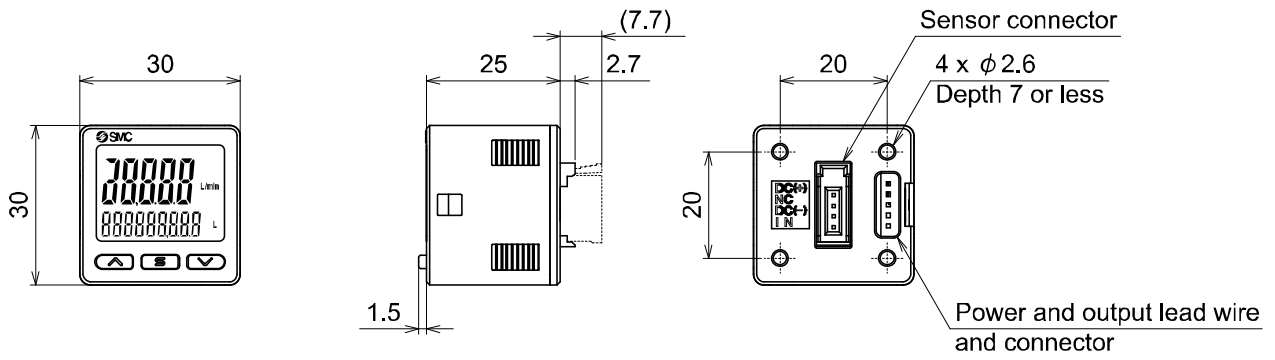

○Bracket A (Part No: ZS-46-A1)

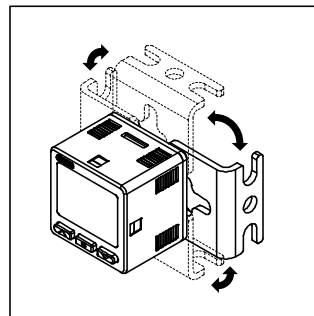
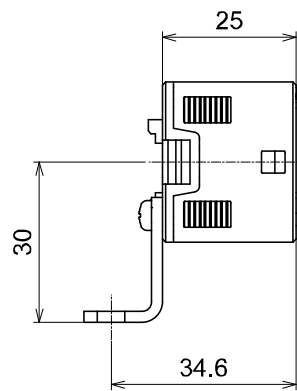
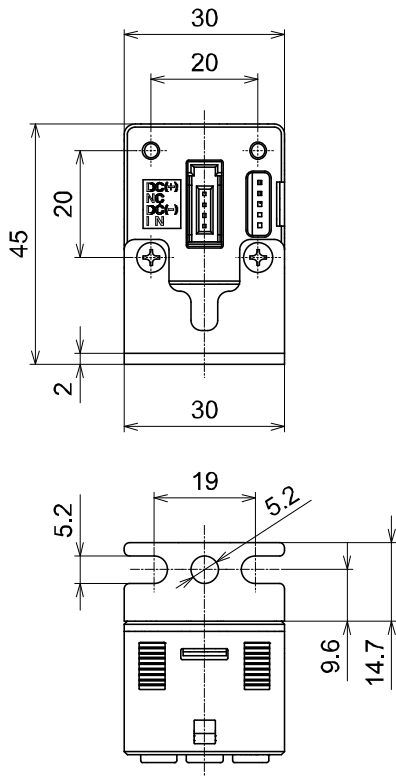

*Bracket can be mounted on 4 sides.

○Bracket B (Part No: ZS-46-A2)

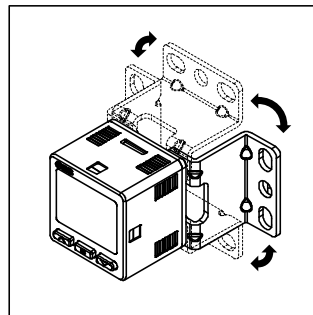
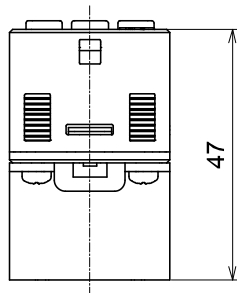

*Bracket can be mounted on 4 sides.

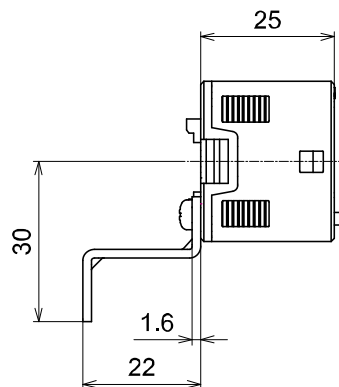
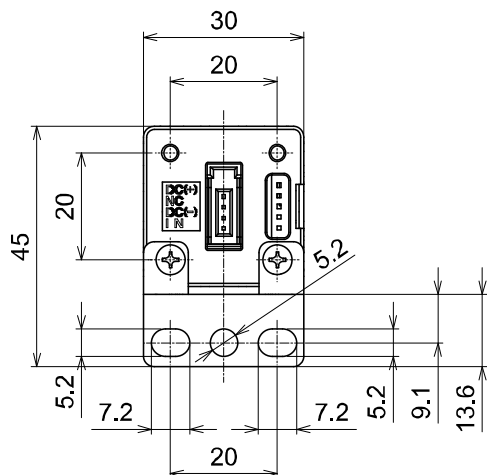

○Panel mount adapter (Part No: ZS-46-B)

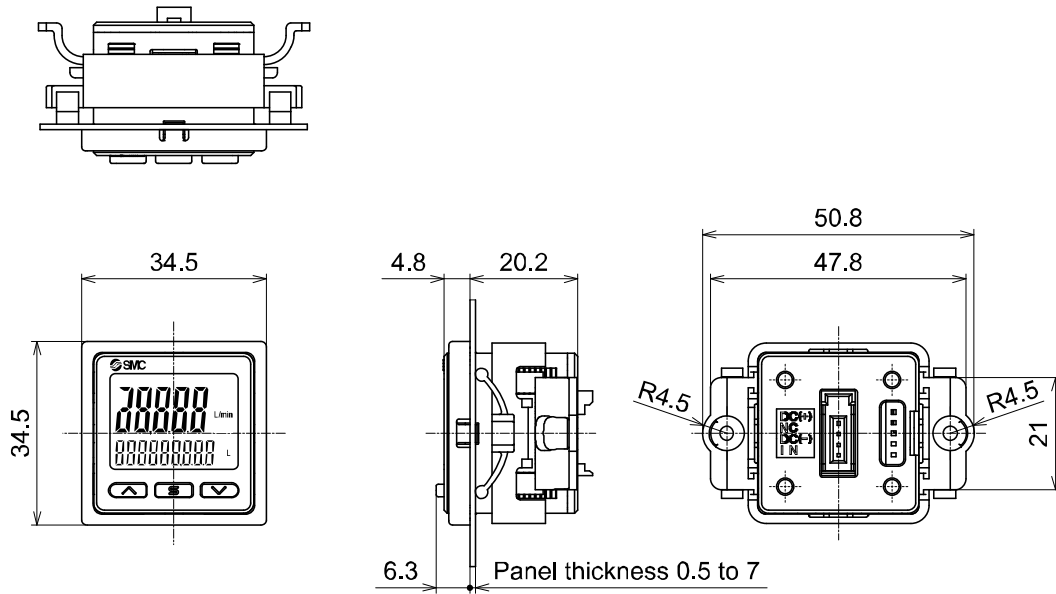

○Panel mount adapter + Front protective cover (Part No: ZS-46-D)

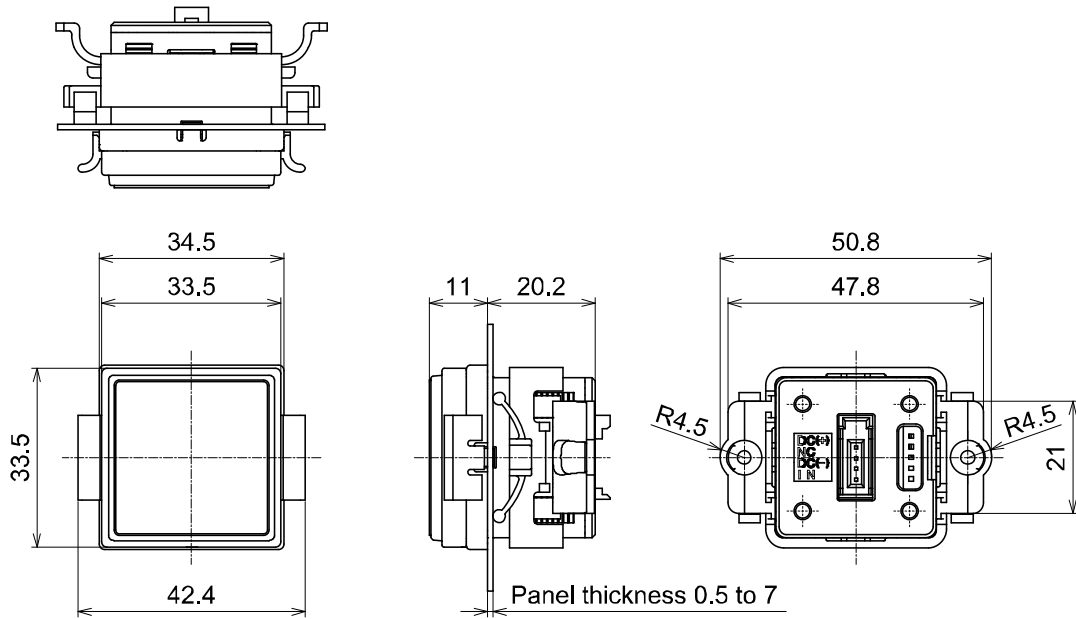

○Lead wire with connector (Part No: ZS-46-5L)

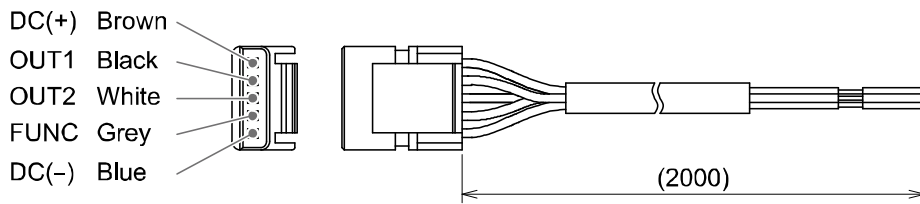

Conductor area		0.15 mm ² (AWG26)
Insulator	Outside diameter	1.0 mm
	Colour	Brown, Blue, Black, white, grey (5 core)
Sheath	Finished outside diameter	φ3.5

○Sensor connector (Part No: ZS-28-C-1)

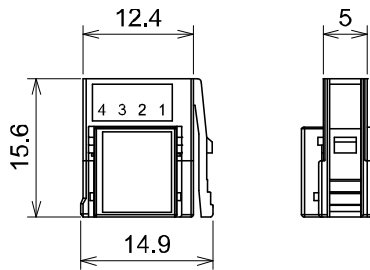

PIN No.	Description
1	DC(+)
2	N.C.
3	DC(-)
4	IN *

*: 1 to 5 V or 4 to 20 mA

○Sensor connector (Part No: ZS-28-CA-4)

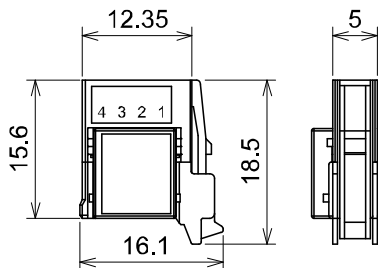

PIN No.	Description
1	DC(+)
2	N.C.
3	DC(-)
4	IN *

*: 1 to 5 V or 4 to 20 mA

○ Panel cut-out dimensions

Mounting individually

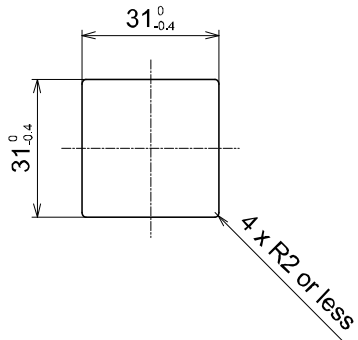

More than 2 pcs. (n pcs.) Close mounting

<Horizontal>

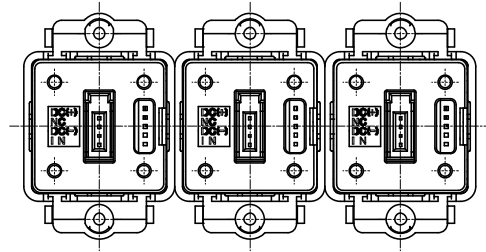
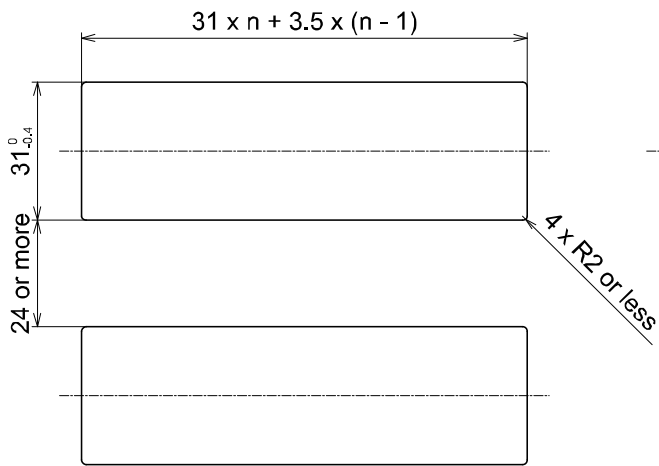

<Vertical>

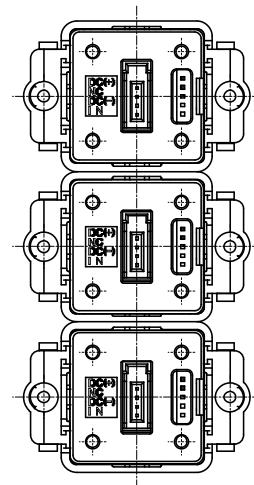
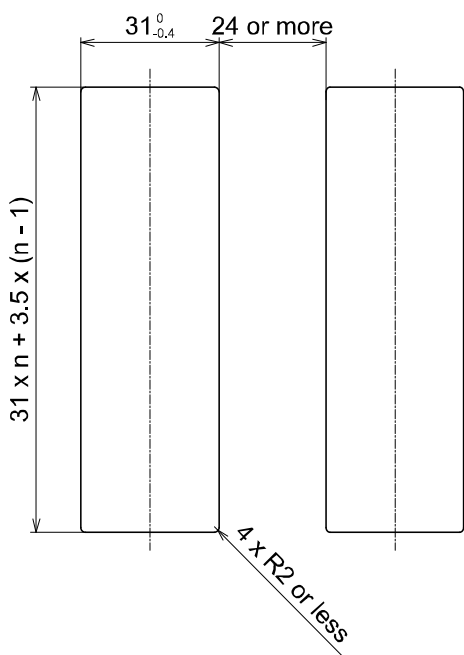

Revision history

- A: Contents are added. [October 2017]
- B: Contents revised in several places. [June 2018]
- C: Contents are added. [May 2021]
- D: Contents revised in several places.
[March 2022]
- E: Contents revised in several places.
[May 2024]

SMC Corporation

Tel: + 81 3 5207 8249 Fax: +81 3 5298 5362
URL <https://www.smcworld.com>

Note: Specifications are subject to change without prior notice and any obligation on the part of the manufacturer.
© SMC Corporation All Rights Reserved

