



Operation Manual

PRODUCT NAME

Digital Flow Switch
(Modular type)

MODEL/ Series/ Product Number

PF3A801H-L
PF3A802H-L

SMC Corporation

Table of Contents

Safety Instructions	4
Model Indication and How to Order	12
Names and Functions of Individual Parts	13
Definition and terminology	16
Mounting and Installation	20
Piping	21
Wiring	23
Outline of Settings [Measurement mode]	26
Change of Set Value [3 step setting mode]	27
Default setting	27
Change of Set Flow and Hysteresis [Simple setting mode]	32
Simple setting mode	30
Change the Function Settings [Function selection mode]	32
Function selection mode	32
Default setting	33
F0 Reference condition/Units selection function/Switch output function/ Output object/Display colour	34
F1 Setting of OUT1	38
F2 Setting of OUT2	45
F3 Select digital filter	46
F6 Fine adjustment of display value	47
F13 Setting for reverse display mode	48
F14 Zero cut-off setting	49
F16 Measurement display setting	53
F30 Setting of accumulated value hold	54
F80 Set display OFF mode	55
F81 Security code	56
F90 Setting of all functions	58
F96 Check of cycle time	60
F98 Setting of output check	61
F99 Reset to the default settings	69

Other Settings	70
Maintenance	73
Forgotten the Security Code	73
IO-Link Specifications	74
Outline of IO-Link functions	74
Communication specifications	74
Process data	75
IO-Link parameter setting	79
Troubleshooting	91
Error display	94
Specifications	97
Characteristics data	101
Dimensions	102



Safety Instructions

These safety instructions are intended to prevent hazardous situations and/or equipment damage. These instructions indicate the level of potential hazard with the labels of “**Caution**,” “**Warning**” or “**Danger**.” They are all important notes for safety and must be followed in addition to International Standards (ISO/IEC)^{*1)}, and other safety regulations.

*1) ISO 4414: Pneumatic fluid power - General rules and safety requirements for systems and their components
ISO 4413: Hydraulic fluid power - General rules and safety requirements for systems and their components
IEC 60204-1: Safety of machinery - Electrical equipment of machines - Part 1: General requirements
ISO 10218-1: Robots and robotic devices - Safety requirements for industrial robots - Part 1: Robots
etc.



Danger

Danger indicates a hazard with a high level of risk which, if not avoided, will result in death or serious injury.



Warning

Warning indicates a hazard with a medium level of risk which, if not avoided, could result in death or serious injury.



Caution

Caution indicates a hazard with a low level of risk which, if not avoided, could result in minor or moderate injury.



Warning

1. The compatibility of the product is the responsibility of the person who designs the equipment or decides its specifications.

Since the product specified here is used under various operating conditions, its compatibility with specific equipment must be decided by the person who designs the equipment or decides its specifications based on necessary analysis and test results. The expected performance and safety assurance of the equipment will be the responsibility of the person who has determined its compatibility with the product. This person should also continuously review all specifications of the product referring to its latest catalog information, with a view to giving due consideration to any possibility of equipment failure when configuring the equipment.

2. Only personnel with appropriate training should operate machinery and equipment.

The product specified here may become unsafe if handled incorrectly. The assembly, operation and maintenance of machines or equipment including our products must be performed by an operator who is appropriately trained and experienced.

3. Do not service or attempt to remove product and machinery/equipment until safety is confirmed.

1. The inspection and maintenance of machinery/equipment should only be performed after measures to prevent falling or runaway of the driven objects have been confirmed.
2. When the product is to be removed, confirm that the safety measures as mentioned above are implemented and the power from any appropriate source is cut, and read and understand the specific product precautions of all relevant products carefully.
3. Before machinery/equipment is restarted, take measures to prevent unexpected operation and malfunction.

4. Our products cannot be used beyond their specifications. Our products are not developed, designed, and manufactured to be used under the following conditions or environments. Use under such conditions or environments is not covered.

1. Conditions and environments outside of the given specifications, or use outdoors or in a place exposed to direct sunlight.
2. Use for nuclear power, railways, aviation, space equipment, ships, vehicles, military application, equipment affecting human life, body, and property, fuel equipment, entertainment equipment, emergency shut-off circuits, press clutches, brake circuits, safety equipment, etc., and use for applications that do not conform to standard specifications such as catalogs and operation manuals.
3. Use for interlock circuits, except for use with double interlock such as installing a mechanical protection function in case of failure. Please periodically inspect the product to confirm that the product is operating properly.



Safety Instructions

Caution

We develop, design, and manufacture our products to be used for automatic control equipment, and provide them for peaceful use in manufacturing industries.

Use in non-manufacturing industries is not covered.

Products we manufacture and sell cannot be used for the purpose of transactions or certification specified in the Measurement Act.

The new Measurement Act prohibits use of any unit other than SI units in Japan.

Limited warranty and Disclaimer/Compliance Requirements

The product used is subject to the following “Limited warranty and Disclaimer” and “Compliance Requirements”. Read and accept them before using the product.

Limited warranty and Disclaimer

1. The warranty period of the product is 1 year in service or 1.5 years after the product is delivered, whichever is first.*2)
Also, the product may have specified durability, running distance or replacement parts. Please consult your nearest sales branch.
2. For any failure or damage reported within the warranty period which is clearly our responsibility, a replacement product or necessary parts will be provided.
This limited warranty applies only to our product independently, and not to any other damage incurred due to the failure of the product.
3. Prior to using SMC products, please read and understand the warranty terms and disclaimers noted in the specified catalog for the particular products.

***2) Vacuum pads are excluded from this 1 year warranty.**

A vacuum pad is a consumable part, so it is warranted for a year after it is delivered.

Also, even within the warranty period, the wear of a product due to the use of the vacuum pad or failure due to the deterioration of rubber material are not covered by the limited warranty

Compliance Requirements

1. The use of SMC products with production equipment for the manufacture of weapons of mass destruction (WMD) or any other weapon is strictly prohibited.
2. The exports of SMC products or technology from one country to another are governed by the relevant security laws and regulations of the countries involved in the transaction. Prior to the shipment of a SMC product to another country, assure that all local rules governing that export are known and followed.

■ Operator

- ◆ This Operation Manual is intended for those who have knowledge of machinery using pneumatic equipment, and have sufficient knowledge of assembly, operation and maintenance of such equipment.
Only those persons are allowed to perform assembly, operation and maintenance.
- ◆ Read and understand this Operation Manual carefully before assembling, operating or providing maintenance to the product.

■ Safety Instructions

Warning

- Do not disassemble, modify (including the replacement of board) or repair.
Otherwise, an injury or failure can result.
- Do not operate the product outside of the specifications.
Do not use the product with flammable or harmful fluids.
Fire, malfunction, or damage to the product may result.
Check the specifications before use.
- Do not use in an environment where flammable, explosive or corrosive gases are present.
Otherwise, fire, explosion or corrosion may occur.
The product is not designed to be explosion proof.
- Do not use the product with flammable fluid
Fire or an explosion may result.
Only air and N₂ are applicable.
- Do not use the product in a place where static electricity is a problem.
Otherwise failure or malfunction of the system can result.
- If using the product in an interlocking circuit
 - Provide a double interlocking system, for example a mechanical system.
 - Check the product regularly for proper operation.Otherwise malfunction can result, causing an accident.
- The following instructions must be followed during maintenance
 - Turn off the power supply.
 - Stop the air supply, exhaust the residual pressure in piping and verify that the air is released before performing maintenance work.Otherwise an injury can result.

Caution

- Do not touch the terminals and connectors while the power is on.
Otherwise electric shock, malfunction and damage to the product can result.
- After maintenance is complete, perform appropriate functional inspections and leak test.
Stop operation if the equipment does not function properly or there is leakage of fluid.
When leakage occurs from parts other than the piping, the product itself may be damaged.
Cut off the power supply and stop the fluid supply.
Do not apply fluid if the system is leaking.
Otherwise, an unexpected malfunction may occur and it will become impossible to ensure safety.

■ Handling Precautions

- Follow the instructions given below for selecting and handling.
 - The instructions on design and selection (installation, wiring, environment, adjustment, operation, maintenance, etc.) described below must be followed.
 - *Product specifications
 - Use the specified voltage.
Otherwise failure or malfunction can result.
Insufficient supply voltage may not drive a load due to a voltage drop inside the product.
Check the operating voltage of the load before use.
 - Do not apply a load that exceeds the max. load voltage or current.
This may cause damage or shorten the lifetime of the product.
 - Data stored by the product is not deleted, even if the power supply is cut off.
(Limit to rewrite: 1,500,000 times)
 - The applicable fluids for this product are dry air and N₂.
The operating fluid temperature range is 0 to 50 °C.
 - Before designing piping confirm the pressure loss (Characteristic data) at the sensor from the pressure loss graph. Confirm pressure loss of the sensor from the characteristics data.
 - For the details of compressed air quality, refer to JIS B 8392: 2012[6: 6: 4].
Use an air filter with 5 μm or less filtration rating on the inlet side.
 - Use within the specified measurement flow rate and operating pressure.
Otherwise it will not be able to perform proper measurement due to delivery delay of the fluid.
 - Reserve a space for maintenance.
Design the system allowing the required space for maintenance.

- **Product handling**

- * **Mounting**

- Tighten to the specified tightening torque.
If the tightening torque is exceeded, the product can be damaged.
Insufficient torque can cause displacement of the product from its proper position and the looseness of the mounting screws.
 - If a commercially available switching power supply is used, be sure to ground the frame ground (FG) terminal.
 - Do not drop, hit or apply excessive shock to the product.
Otherwise damage to the internal components may result, causing malfunction.
 - Do not pull the lead wire forcefully, or lift the product by the lead wire.
(Tensile strength 49 N or less)
Hold the product by the body when handling to prevent damage.
 - Any dust left in the piping should be flushed out by air blow before connecting the piping to the product.
Otherwise it can cause damage or malfunction.
 - Refer to the flow direction of the fluid indicated on the product body for installation and piping.
 - Do not mount the body with the bottom facing upwards.
Do not mount the product with the display facing upward.
Retention of air can cause inability to measure accurately.
 - Do not insert metal wires or other foreign matter into the flow path.
This can damage the sensor causing failure or malfunction.
 - Never mount the product in a place that will be used as a scaffold during piping.
The product may be damaged if excessive force is applied by stepping or climbing onto it.
 - Do not apply excessive rotation force to the monitor.
The monitor with integrated display can be rotated 90° clockwise.
Rotating the display with excessive force will damage the end stopper.
 - Visibility decreases if the display is viewed from the opposite side to the buttons.
Check the settings and display from in front of the display.
 - If there is a risk of foreign matter entering the fluid, install a filter of mist separator at the inlet to avoid failure and malfunction.
Otherwise it can cause damage or malfunction. Or the flow switch will become unable to measure accurately.
Air quality specified in the product specifications can be satisfied by using the pneumatic circuit below.
 - If the fluid flow on the IN side (entry side) of the product is unstable, correct measurement will not be possible.
If a valve is used on the IN side (entry side) of the product, the fluid may be unstable due to the change of the effective area, and there may be an error in the flow measurement results.
 - If a residual pressure release 3-port valve is installed on the inlet side of the flow switch and air flows backward, the displayed flow rate will fluctuate.
 - Avoid installing the lubricator on the inlet side of the digital flow switch as it may cause oil inflow and damage internal parts.

Recommended pneumatic circuit example (for compressed air)

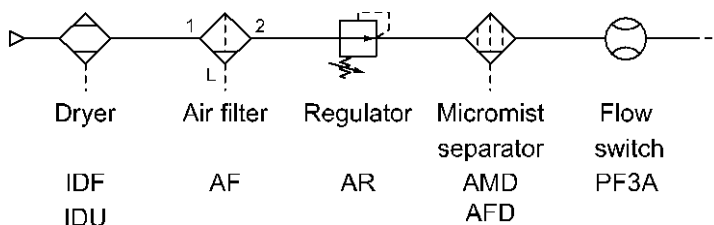

*Wiring (Including connecting/ disconnecting of the connectors)

- Do not pull hard on the lead wire. Especially never lift the product equipped with fitting and piping by holding the lead wires.

Damage to the connector, circuit board, cover or internal components may result, causing failure or malfunction.

- Avoid repeatedly bending, stretching or applying a heavy object or force to the lead wire.

Repetitive bending stress or tensile stress can cause the sheath of the wire to peel off, or breakage of the wire.

If the lead wire can move, secure it near the body of the product.

The recommended bend radius of the lead wire is 6 times the outside diameter of the sheath, or 33 times the outside diameter of the insulation material, whichever is larger.

Replace the damaged lead wire with a new one.

- Wire correctly.

Incorrect wiring may cause malfunction or damage to the product.

- Do not perform wiring while the power is on.

Otherwise damage to the internal components may result, causing malfunction.

- Do not route wires and cables together with power or high voltage cables.

Route the wires of the product separately from power or high voltage cables to prevent noise and surge from entering the product.

- Confirm correct insulation of wiring.

Poor insulation (interference with other circuits, poor insulation between terminals etc.) can apply excessive voltage or current to the product causing damage.

- Keep wiring as short as possible to prevent interference from electromagnetic noise and surge voltage.

Do not use a cable longer than 20 m.

Wire the DC(-) line (blue) as close as possible to the power supply.

*Operating environment

- Do not use the product in an environment where the product is constantly exposed to water splashes. Otherwise failure or malfunction can result. Take measures such as using a cover.
- Do not use the product in an environment where corrosive gases or fluids can be splashed. Otherwise damage to the internal parts can result, causing malfunction.
- Do not use the product in a place where the product could be splashed by oil or chemicals. If the product is to be used in an environment containing oils or chemicals such as coolant or cleaning solvent, even for a short time, it may be adversely affected (damage, malfunction, or hardening of the lead wires).
- Do not use in an area where surges are generated. When there are machines or equipment that generate large surges near the product (magnetic type lifter, high frequency inductive furnace, motor, etc.), this can result in deterioration and damage of the internal components. Take protective measures to isolate the surge sources, and prevent the lines from coming into close contact.
- Do not use a load which generates surge voltage. When a surge-generating load such as a relay or solenoid is driven directly, use a load with a built-in surge suppressor.
- The product is CE/UKCA marked, but not immune to lightning strikes. Take measures against lightning strikes in the system.
- Mount the product in a location that is not affected by vibration or impact. Otherwise it can cause damage or malfunction.
- Do not use the product in the presence of a magnetic field. Malfunction can result.
- Do not let foreign matter, such as wire debris, get inside the product. Otherwise it can cause damage or malfunction.
- Do not use the product in an environment that is exposed to temperature cycle. Heat cycles other than ordinary changes in temperature can adversely affect the internal components of the product.
- Do not expose the product to direct sunlight. If using in a location directly exposed to sunlight, protect the product from the sunlight. Failure or malfunction may occur.
- Keep within the specified ambient temperature range. The ambient temperature range is 0 to 50 °C. Operation under low temperature may lead to damage or operation failure due to frozen moisture in the fluid or air. Protection against freezing is necessary. Mounting of an air dryer is recommended for elimination of drainage and water. Avoid abrupt temperature changes even within the specified temperature range.
- Do not operate close to a heat source, or in a location exposed to radiant heat. Insufficient air quality may cause operation failure.

*Adjustment and Operation

- Connect the load before turning the power supply on.
- Do not short-circuit the load.
Although error is displayed when the product load has a short circuit, generated over current may lead to the damage of the product.
- Do not press the setting buttons with a sharp pointed object.
This may damage the setting buttons.
- Supply power under no flow conditions.
- If using the product to detect very small flow differences, warm up the product for 10 to 15 minutes first.
There will be a drift on the display of approx 2 to 3% for 10 minutes after the power supply is turned on.
- The product doesn't produce and output signal for 3 seconds after the power is supplied.
- Perform settings suitable for the operating conditions.
Incorrect setting can cause operation failure.
- During the initial setting, the product will switch the measurement output with the condition before setting.
Check the effect to the equipment before setting.
Stop the control system for setting, if necessary.
- Do not touch the LCD during operation.
The display can vary due to static electricity.

*Maintenance

- Perform regular maintenance and inspections.
There is a risk of unexpected failure of components due to the malfunction of equipment and machinery.
- Before performing maintenance, turn off the power supply, stop the air supply, exhaust the residual compressed air in the piping, and verify the release of air.
Otherwise, unintended malfunction of system components can result.
- Remove the condensate periodically.
If condensate enters the secondary side, it can cause operating failure of pneumatic equipment.
- Do not use solvents such as benzene, thinner etc. to clean the product.
This may damage the surface of the body or erase the markings on the body.
Use a soft cloth to remove stains.
For heavy stains, use a damp cloth that has been soaked with diluted neutral detergent and fully squeezed, then wipe up the stains again with a dry cloth.

Model Indication and How to Order

PF3A 8 □ H - □ □ - □ □ - □

Type

Symbol	Type
8	Pressure/Temperature

Rated flow range (Flow range)

Symbol	Flow range	Air combination
01	10 to 1000 L/min	AC30-D
02	20 to 2000 L/min	AC40-D

Large flow type

Output specification

Symbol	OUT1	OUT2
L2	IO-Link/Switch output (N/P)	Switch output (N/P)

Lead wire

Symbol	Content
Nil	With lead wire with M12 connector (3 m) *1
N	No lead wire
Q	With lead wire with M12-M12 connector (3 m) *2

*1: Accessory is not assembled with the product, but shipped together.
 *2: One end has an M12 (female) connector and the other end has an M12 (male) connector.

Flow direction

Symbol	Content
Nil	Left → Right
R	Right → Left

Calibration certificate (Flow rate/Pressure only)

Symbol	Content
Nil	Without calibration certificate
A *5	With calibration certificate

*5: Certificate in both Japanese and English.
 *: Made to Order.

Unit specification

Symbol	Content
Nil	Units selection function *3
M	SI unit only *4

*3: Since the unit for Japan is fixed to SI due to new measurement law, this option is for overseas.
 *4: Fixed unit: Instantaneous flow: L/min
 Accumulated flow: L
 Pressure: kPa, MPa
 Temperature: °C

Accessories/Part numbers

If an accessory is required, order using the following part number.

Product number	Description	Note
ZS-37-A	Lead wire with M12 connector	Length: 3 m
ZS-49-A	Lead wire with M12 connector	Length: 3 m, M12 (female) - M12 (male)

Names and Functions of Individual Parts

Body

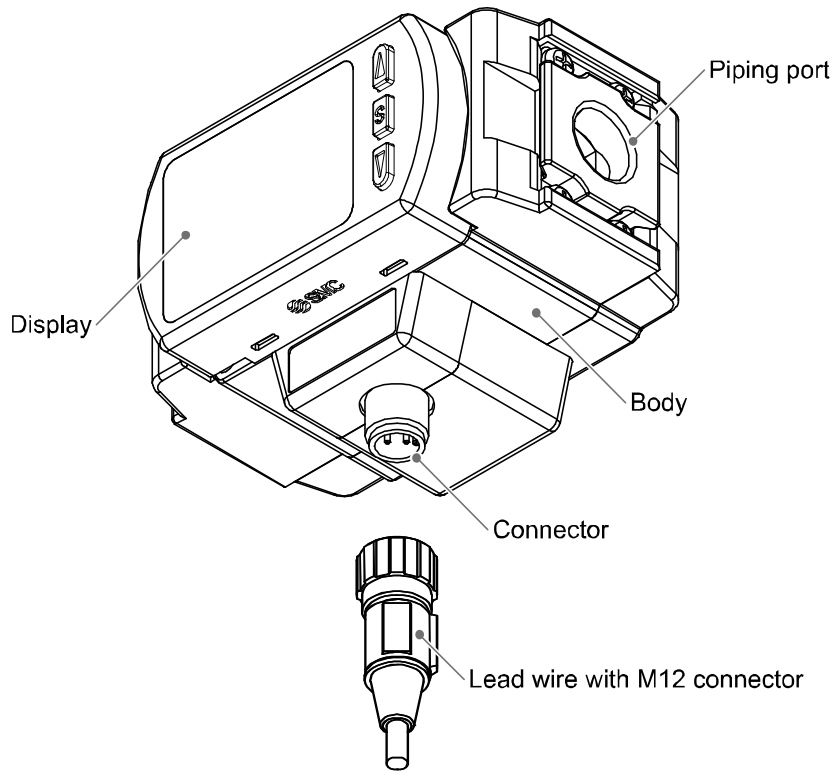

Connector pin numbers
(on the product)

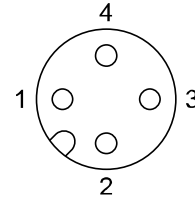

1	DC(+)
2	OUT2
3	DC(-)
4	OUT1 (C/Q)



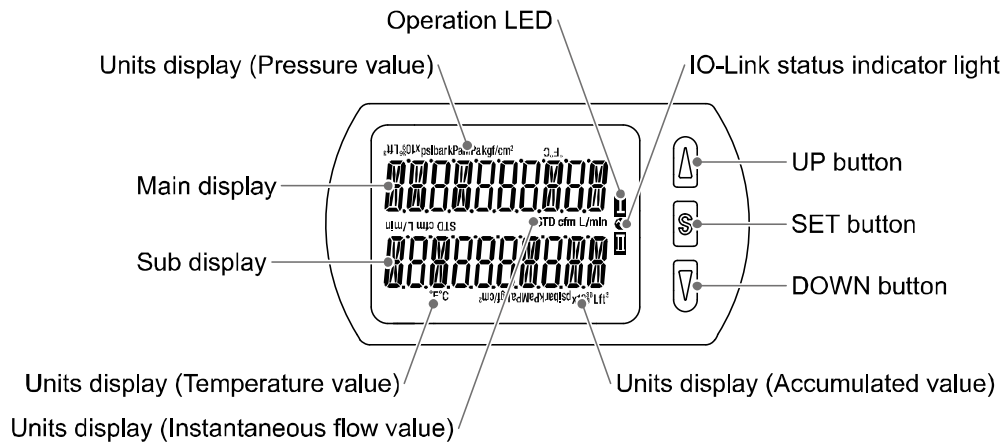

Element	Description
Display	Refer to the Display on the next page.
Connector	M12 4-pin connector for electrical connections.
Lead wire with M12 connector	Lead wire for power supply and outputs.
Piping port	For piping connections.
Body	The body of the product.

Display



Element	Description
Main display	Displays the instantaneous flow value, pressure value and error codes. (2 colour display)
Operation LED	Indicates the output status of OUT. When the output is ON: Orange LED is ON. When the accumulated pulse output mode is selected, the output display will turn off.
Sub display	Displays the accumulated flow, temperature value, set value, and peak/ bottom value when in measurement mode.
UP button	Selects the mode and the display shown on the Sub display, or increases the switch point.
SET button	Press this button to change the mode and to set a value.
DOWN button	Selects the mode and the display shown on the Sub display, or decreases the switch point.
Units display (Instantaneous flow value)	Indicates the flow measurement units currently selected.
Units display (Accumulated value)	Indicates the flow measurement units currently selected.
Units display (Pressure value)	Indicates the flow measurement units currently selected.
Units display (Temperature value)	Indicates the flow measurement units currently selected.
IO-Link status indicator light	LED is ON when OUT1 is used in IO-Link mode. (LED is OFF in SIO mode)

•IO-Link indicator light operation and display

Communication with master	IO-Link status indicator light	Status			Main screen display *1	Content
						
Yes		IO-Link mode	Correct	Operate	Mode oPE	Normal communication status (Reading of measured value)
				Start up	Mode StPt	When communication starts up.
				Preoperate	Mode PrE	
		Abnormal	Version does not match	Er 15 V 10	Version of master and IO-Link does not match *2	
No		IO-Link mode	Abnormal	Communication shut-off	Mode StPt Mode PrE Mode oPE	Correct communication was not received for 1 second or more.
					SIO mode	Mode Sio

LCD display: "O" OFF, "●" Flashing, "●" ON

*1: "ModE - - -" is displayed when selecting the modes on the main screen.

*2: When the product is connected to the IO-Link master with version other than "V1.1", an error is generated.

■ Definition and terminology

	Term	Definition
A	Accumulated flow	The total amount of fluid that has passed through the device. If an instantaneous flow of 100 L/min lasts for 5 minutes, the accumulated flow will be $5 \times 100 = 500$ L. If the lower digits exceed the display range, the upper digits and lower digits are displayed alternately. (3-second cycle) When the upper digits are displayed, "10 ³ or 10 ⁶ or 10 ⁹ " lights up according to the totalized flowrate.
	Accumulated pulse output	A type of output where a pulse is generated every time a predefined accumulated flow passes. It is possible to calculate the total accumulated flow by counting the pulses.
	Accumulated-value hold time	A function to store the cumulative flow value in the product's internal memory at certain time intervals. Reads the memory data when power is supplied. Accumulation of data begins with the value read at the moment power is supplied. The time interval for memorizing can be selected from 2 or 5 minutes.
B	Bottom value display (mode)	Shows the minimum from when the power was supplied to the current time.
C	Chattering	The problem of the switch output turning ON and OFF repeatedly around the set value at high frequency due to the effect of pulsation.
D	Delay time	The setting time from when the measured value reaches the set value, to when the ON-OFF output operates. Delay time setting can prevent the output from chattering.
	Digital filter	Function to add digital filtering to the fluctuation of measured value. Smooth the fluctuation of displayed value for sharp start up or fall of the flow and pressure. When the function is valid, digital filtering is reflected to the ON/OFF of the switch output. The response time indicates when the set value is 90% in relation to the step input. Output chattering or flicker in the measurement mode display can be reduced by setting the digital filter. The response time indicates when the set value is 90% in relation to the step input.
	Display accuracy	Indicates the maximum deviation between the displayed pressure value and the true value.
	Display colour	Indicates the colour of the number of digital display. Always green, always red, green (switch OFF) → red (switch ON), red (switch OFF) → green (switch ON) are available.
	Display value fine adjustment (function)	Displayed pressure value can be adjusted within the range of $\pm 5\%$ R.D. ($\pm 5\%$ of displayed value). It is used if the true pressure value is known, or to eliminate differences between the displayed values of different instruments that are measuring the same pressure.
E	Error displayed	The code number displayed, identifying the error detected by the self-diagnosis function of the flow switch. Refer to the "Error display" on page 94 for details of the errors.
	Error output	Switches the switch output to ON/OFF when an error is displayed. Refer to "Switch output modes" on page 38 for operating conditions. Refer to the "Error display" on page 94 for details of the errors.

	Term	Definition
F	F.S. (full span/full scale)	Abbreviation of full span and full scale; difference between the minimum and maximum rated pressure values. means the maximum fluctuation range of the pressure switch rated value. For example, when the rated pressure range is 0 to 1.000 [MPa]: F.S. = 1.000 - 0 = 1 [MPa] (Reference: 1%F.S. = 1 x 0.01 = 0.01 [MPa])
	Function selection mode	A mode in which setting of functions is performed. It is a separate menu from the switch setting. If any function settings need to be changed from the factory default, each setting can be selected with "F*". The setting items are: output mode, display colour, digital filter, display reverse, zero cut-off display on/off, display value fine adjustment, use of display OFF mode, and use of security code.
H	Hysteresis	The difference between ON and OFF points used to prevent chattering. Hysteresis can be effective in avoiding the effects of pulsation.
	Hysteresis mode	Mode where the switch output will turn ON when the measured value is greater than the set value and will turn OFF when the flow rate falls below the set value by the amount of hysteresis or more. Mode where the switch output will turn ON when the flow is greater than the set value, and will turn OFF when the flow falls below the set value by the amount of hysteresis or more.
I	Instantaneous flow	The flow passing per unit of time. If it is 10 L/min, there is a flow of 10 L passing through the device in 1 minute.
	Insulation resistance	Insulation resistance of the product. The resistance between the electrical circuit and the case.
	Internal voltage drop	The voltage drop across the product (and therefore not applied to the load), when the switch output is ON. The voltage drop will vary with load current, and ideally should be 0 V.
K	Key-lock function	Function that prevents changes to the settings of the flow switch (disables button operation).
M	Maximum applied voltage	The maximum voltage that can be connected to the output of an NPN device.
	Maximum load current	The maximum current that can flow to the output (output line) of the switch output.
	Measurement mode	Operating condition in which flow rate, pressure and temperature is detected and displayed, and the switch function is operating. Operating condition in which pressure is being detected and displayed, and the switch function is working.
N	Normal condition	The flow which is converted into the volume at 0 °C and 101.3 kPa (absolute pressure). <nor> indicates that the product is in normal condition.
	Normal output	One of the switch output types. In hysteresis mode the switch output is turned ON when pressure equal to or greater than the switch output set value is detected. In window comparator mode, the switch output is turned ON when measured value between the switch output set values (P1L to P1H) is detected. (Refer to the "Switch output modes" on page 38.)

	Terminology	Definition
O	Operating fluid temperature	Range of fluid temperature that can be measured by the product.
	Operating humidity range	Humidity range in which the product can operate.
	Operation mode	Hysteresis mode, window comparator mode, Error output or Output OFF can be selected.
	Operating temperature range	Ambient temperature range in which the product can operate.
	Output light	A light that turns on when the switch output is ON.
P	Peak value display (mode)	Shows the maximum from when the power was supplied to the current time.
	Pressure characteristics	Indicates the change in the display value when the fluid pressure changes.
	Proof pressure	Pressure limit that if exceeded will result in mechanical and/or electrical damage to the product.
R	R.D.	Current read value For example, when the display value is 1.000 [MPa], $\pm 5\%$ R.D. is $\pm 5\%$ of 1.000 [MPa], which becomes ± 0.05 [MPa]. When the display value is 0.800 [MPa], $\pm 5\%$ R.D. is $\pm 5\%$ of 0.800 [MPa], which becomes ± 0.04 [MPa].
	Rated flow range	The flow range within which the product will meet all published specifications. Values outside of this range can be set as long as they are within the set flow range, but the specifications cannot be guaranteed.
	Rated pressure range	The pressure range within which the product will meet all published specifications. Values outside of this range can be set as long as they are within the set pressure range, but the specifications cannot be guaranteed.
	Rated temperature range	The temperature range within which the product will meet all published specifications. Values outside of this range can be set as long as they are within the set temperature range, but the specifications cannot be guaranteed.
	Repeatability	Reproducibility of the display value, when the measured quantity is repeatedly increased and decreased.
	Residual voltage	The difference between the ideal ON voltage and the actual voltage when the switch output is on. Varies with load current. Ideally should be 0 V.
	Reversed output	One of the switch output types. In hysteresis mode the switch output is turned ON when measured value less than or equal to the switch output set value is detected. In window comparator mode, the switch output is turned ON when measured value is outside the switch output set values (n1L to n1H) is detected. (Refer to the "Switch output modes" on page 38.)

	Terminology	Definition
S	Set point range	The flow rate range that can be set for switch output.
	Set pressure range	The pressure range that can be set for switch output.
	Set temperature range	The switch output range that can be set for temperature.
	Smallest settable increment	The resolution of set and display values. If the minimum setting unit is 2 L/min, the display will change in 2 L/min steps, e.g. 30.....32.....34 L/min.
	Standard condition	The flow which is converted to the volume at 20 °C and 101.3 kPa (absolute pressure). <Std> indicates that the product is standard condition.
	Switch operating	The operation principle of the switch output. Normal output and reverse output can be selected. Refer to the "Switch output modes" on page 38 for operating conditions.
	Switch output	Output type that has only 2 conditions, ON or OFF. In the ON condition an indicator LED will show, and any connected load will be powered. In the OFF condition, there will be no indicator LED and no power supplied to the load. An output showing such behavior is called switch output.
T	Temperature characteristics	Indicates the change in the display value caused by ambient temperature changes.
U	Units selection function	A function to select display units other than the international unit (SI unit) specified in the new Japanese measurement law. The product is not equipped with this function.
W	Wetted part	A part that comes into physical contact with the fluid.
	Window comparator mode	An operating mode in which the switch output is turned ON and OFF depending on whether the measured value is inside or outside the range of two set values. An operating mode in which the switch output is turned on and off depending on whether the flow is inside or outside the range of two set values
	Withstand voltage	A measure of the product's resistance to a voltage applied between the electrical circuit and case. Durability in withstanding voltage. The product may be damaged if a voltage over this value is applied. (The withstand voltage is not the supply voltage used to power the product.)
Z	Zero-clear function	This function to adjust the displayed pressure to zero.

Mounting and Installation

Mounting

- Avoid mounting in the direction that the display faces upward.
 - Never mount the product upside down.
 - The monitor with integrated display can be rotated.
- Rotating the display with excessive force will damage the end stop.

○ Flow direction

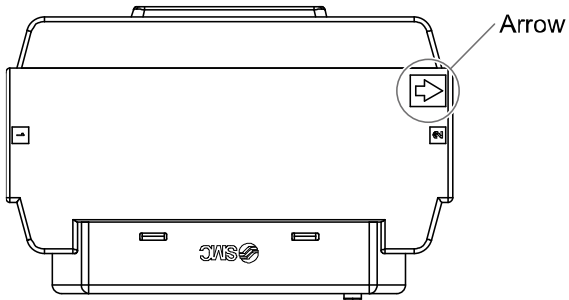

Flow direction: Left → Right

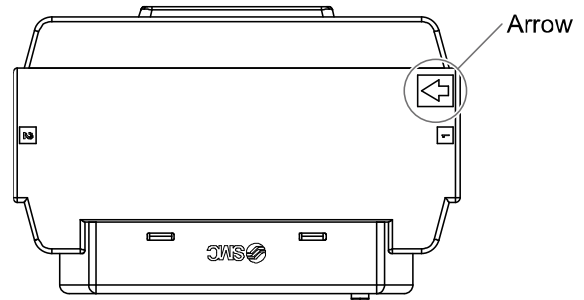

Flow direction: Right → Left

○ Rotation of the display

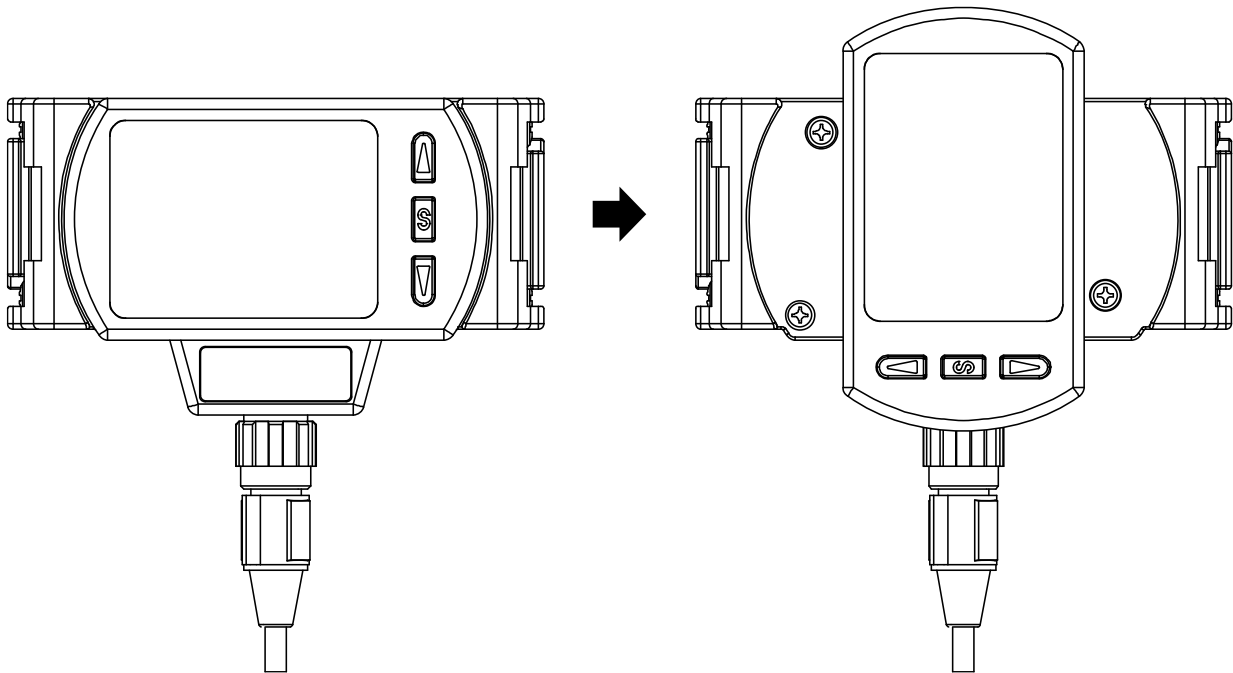

■Piping

- Fit the raised part of the spacer to the recessed part (groove for the raised part) of the product.
 - Tighten the retainer A with two hexagon socket head cap screws temporarily.
 - Tighten the two hexagon socket head cap screws with a hexagonal wrench evenly.
- Refer to the control items shown below for the tightening torque for the screws.

Control items

Applicable model	Hexagonal wrench socket size Nominal value	Tightening torque
PF3A801H	3	1.2±0.05 N•m
PF3A802H		

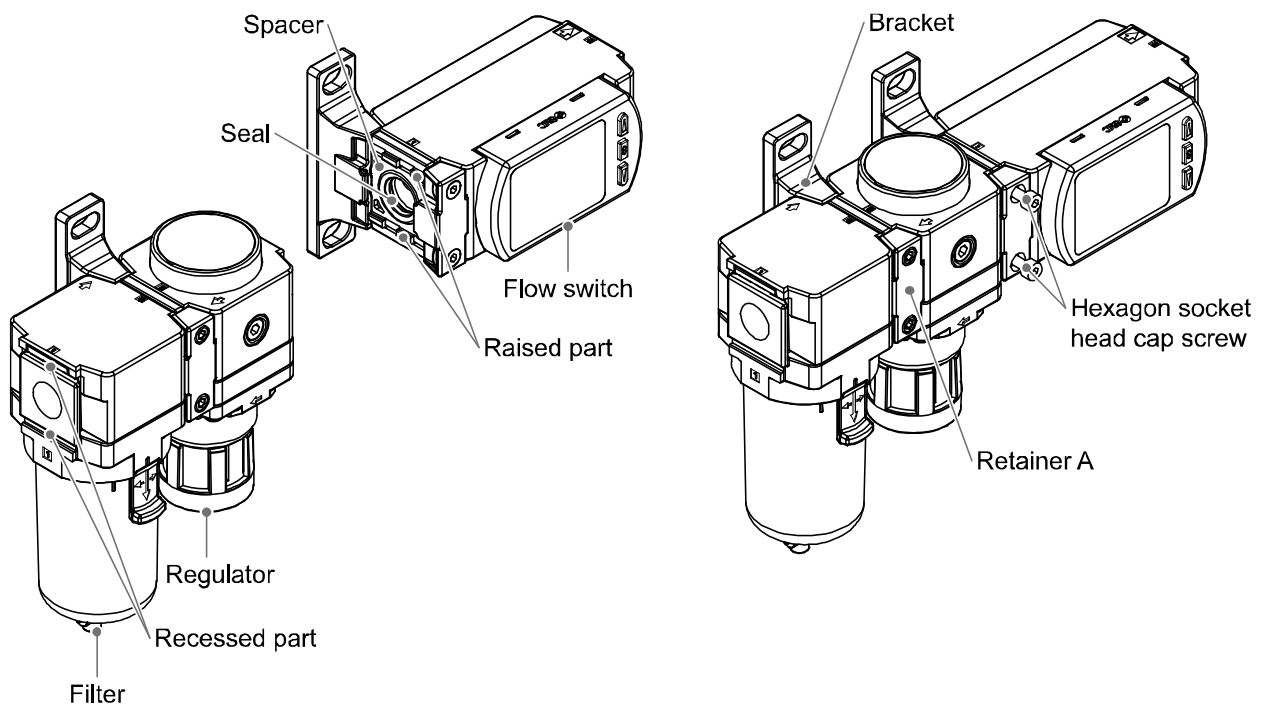

- The following options are required for coupling with modular F, R, and L combinations. They are separately prepared by the user.

Digital flow switch	Air combination	Spacer	Spacer with bracket	Pipe adapter
PF3A801H	AC30#-D	Y300-D	Y300T-D	E300-#03-D
PF3A802H	AC40#-D	Y400-D	Y400T-D	E400-#04-D

*: For more information about the options, refer to our website (URL <https://www.smcworld.com>).

<Caution>

•Do not apply torsion or bending moment other than the weight of the product itself. External piping needs to be supported separately as it may cause damage. If a moment applied to the equipment is unavoidable during operation, the moment should be lower than the maximum moment shown below. Non-flexible piping like steel tube is susceptible to excessive moment load or vibration. Insert flexible tubes to prevent this.

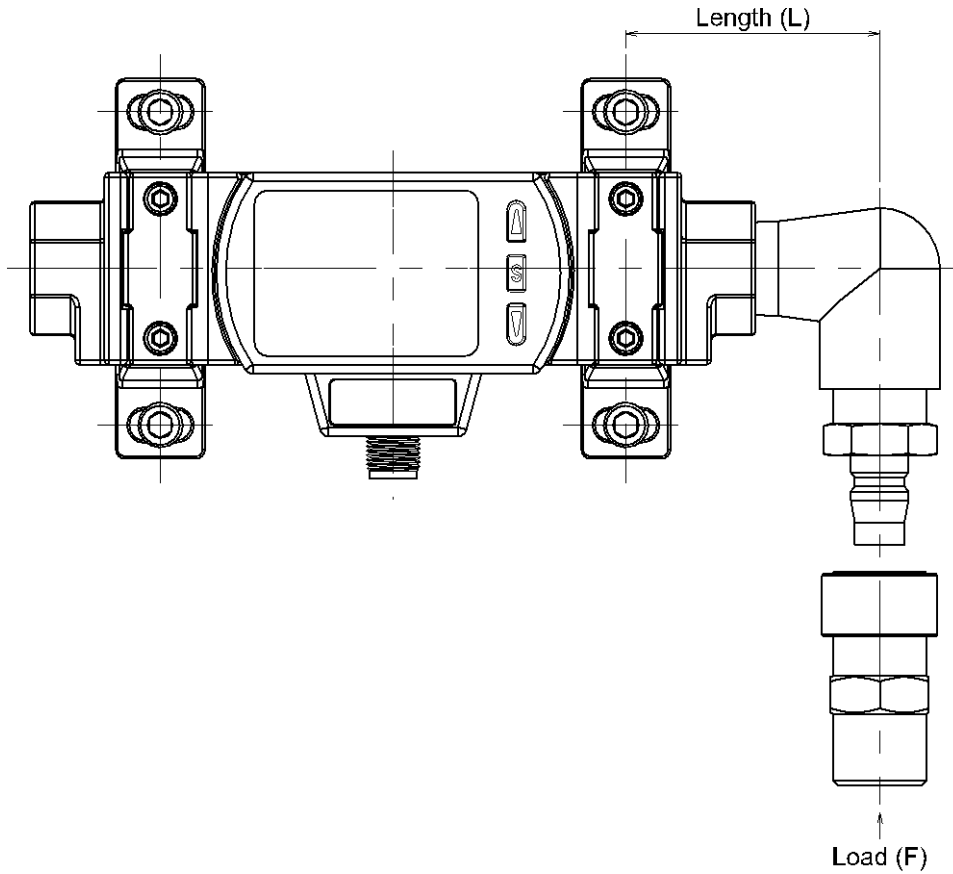

Models	PF3A801H	PF3A802H
Maximum moment (M): N•m	16	19.5

Max. moment (M) = Length (L) x Load (F)

■ Wiring

Connection

- Connections should only be made with the power supply turned off.
- Use a separate route for the product wiring and any power or high voltage wiring. If wires and cables are routed together with power or high voltage cables, malfunction may result due to noise.
- If a commercially available switching power supply is used, be sure to ground the frame ground (FG) terminal. If the product is connected to the commercially available switching power supply, switching noise will be superimposed and the product specifications will not be satisfied. In that case, insert a noise filter such as a line noise filter/ ferrite between the switching power supplies or change the switching power supply to the series power supply.

Connecting/Disconnecting

- Align the lead wire connector with the connector key groove, and insert it straight in. Turn the knurled part clockwise. Connection is complete when the knurled part is fully tightened. Check that the connection is not loose.
- To remove the connector, loosen the knurled part and pull the connector straight out.

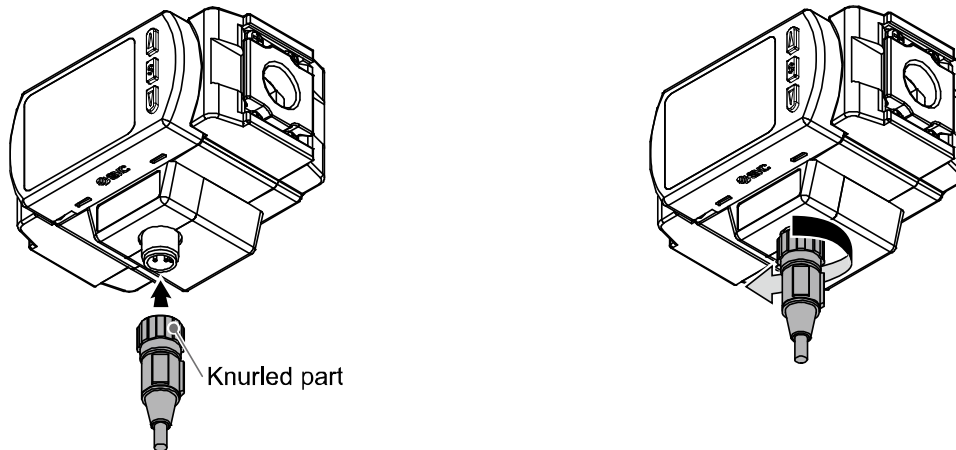

Connector pin numbers (lead wire)

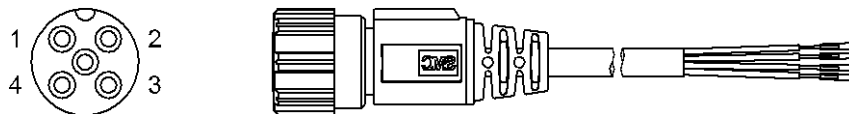

•Used as switch output device

Pin number	Wire colour	Description	Function
1	Brown	DC(+)	24 VDC
2	White	OUT2	Switch output
3	Blue	DC(-)	0 V
4	Black	OUT1	Switch output

•Used as IO-Link device

Pin number	Wire colour	Description	Function
1	Brown	DC(+)	24 VDC
2	White	OUT2	Switch output
3	Blue	DC(-)	0 V
4	Black	C/Q	Communication data (IO-Link)/Switch output (SIO)

Internal circuit and wiring examples

PF3A8##H-L2#-##-#

NPN type

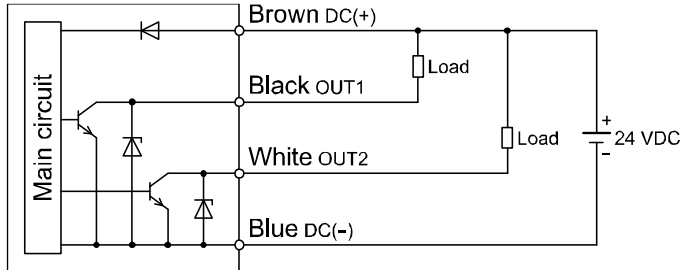

Maximum applied voltage: 30 V

Maximum load current: 80 mA

Internal voltage drop: 1.5 V or less

PF3A8##H-L2#-##-#

PNP type

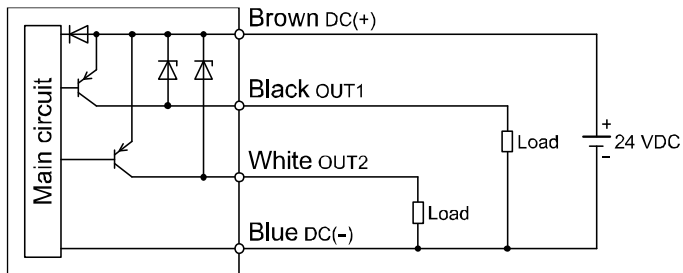

Maximum load current: 80 mA

Internal voltage drop: 1.5 V or less

Example of wiring for accumulated pulse output

NPN type

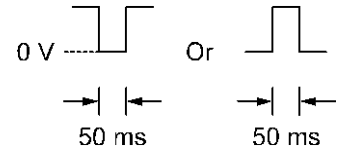
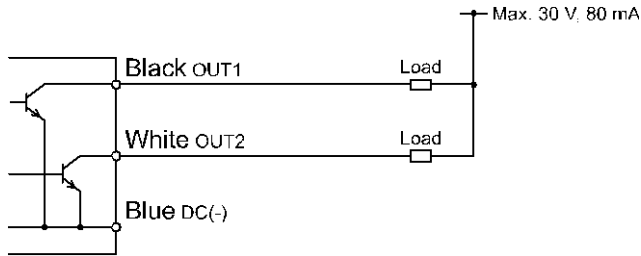

PNP type

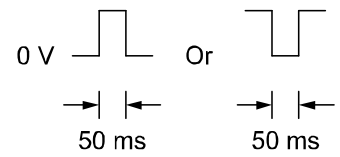
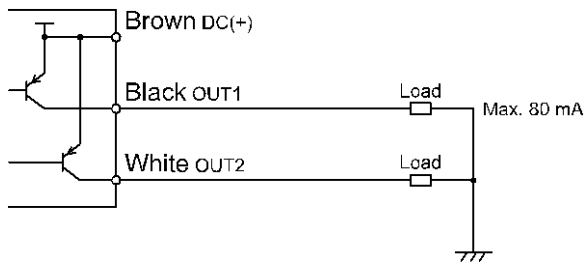

Used as IO-Link device

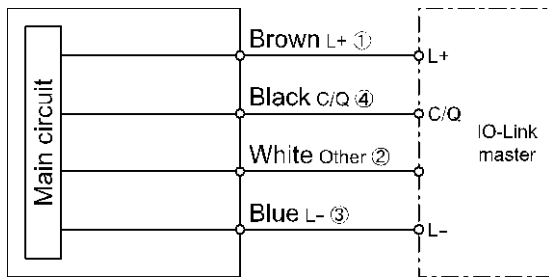

*: Numbers in the figures show the connector pin layout.

Outline of Settings [Measurement mode]

Power is supplied.



The output will not operate for 3 seconds after supplying power.
The identification code of the product is displayed.



[Measurement mode]

Measurement mode is the condition where the flow, pressure, and temperature are detected and displayed, and the switch function is operating. This is the basic mode; other modes should be selected for set-point changes and other function settings.

Measurement mode screen

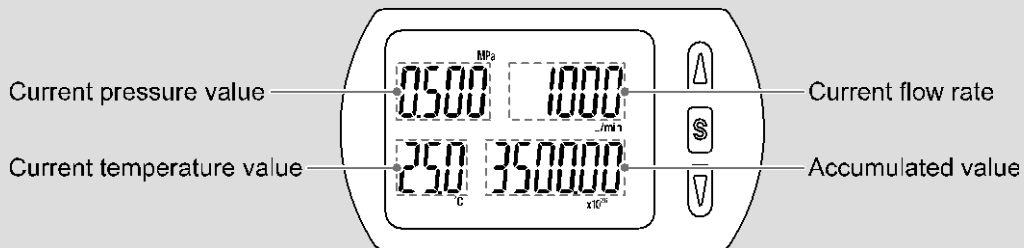

In measurement mode, the display can be changed by pressing the UP or DOWN button.

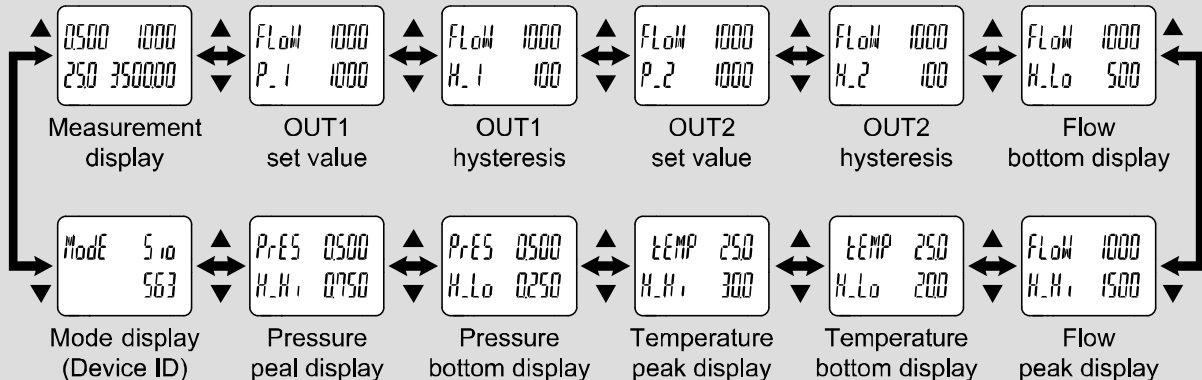

*: The example shown is for the 2000 L/min type.

*: Flow rate, pressure, temperature, accumulated, pulse output, error output, and output OFF can be selected for setting OUT1 and OUT2.

Press SET button once.

Press the SET button for 1 to 3 seconds.

Press the SET button for 3 to 5 seconds.



Change of Set Value
(3 step setting mode)
(Refer to page 27)

Change of Set Flow and Hysteresis
(Simple setting mode)
(Refer to page 30)

Change the Function Settings
(Function selection mode)
(Refer to page 32)

Other Settings
(Refer to page 70)

*: The outputs will continue to operate during setting.

*: If a button operation is not performed for 3 seconds during the setting, the display will flash. (This is to prevent the setting from remaining incomplete if, for instance, an operator were to leave during setting.)

*: 3 step setting mode, simple setting mode, and function selection mode settings will reflect on each other.

Change of Set Value [3 step setting mode]

3 step setting mode

In the 3 step setting mode, the set value selected in the display and the hysteresis can be changed in just 3 steps.

Use this mode if the product is to be used straight away, after changing only the set values.

(The current measured value is displayed on the main display.)

■ Default setting

When the flow exceeds the set value [P_1], the switch will be turned ON.

When the flow falls below the set value by the amount of hysteresis [H_1] or more, the switch will turn OFF.

If the operation shown below is acceptable, then keep these settings.

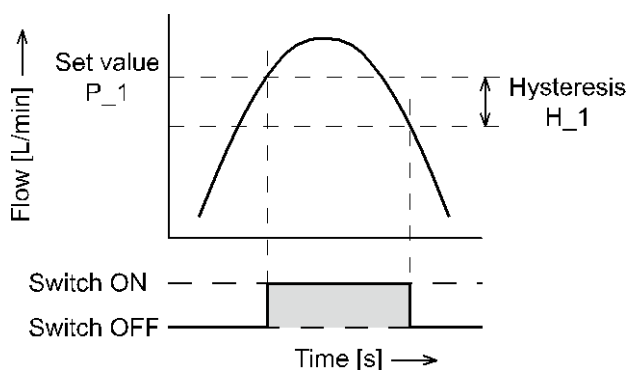

● PF3A801H

Item	Default Settings
[P_1] Set value of OUT1	500 L/min
[H_1] Hysteresis of OUT1	50 L/min
[P_2] Set value of OUT2	500 L/min
[H_2] Hysteresis of OUT2	50 L/min

● PF3A802H

Item	Default Settings
[P_1] Set value of OUT1	1000 L/min
[H_1] Hysteresis of OUT1	100 L/min
[P_2] Set value of OUT2	1000 L/min
[H_2] Hysteresis of OUT2	100 L/min

*: For hysteresis, please refer to [F 1] Setting of OUT1 (page 38).

<Operation>

[Hysteresis mode]

In the 3 step setting mode, the set value ([P_1]/[P_2] or [n_1]/[n_2]) and hysteresis ([H_1]/[H_2]) can be changed.

Set the items on the display (set value and hysteresis) using the UP or DOWN buttons.

When changing the set value, follow the operation below. The hysteresis setting can be changed in the same way.

- (1) Press the SET button once when the item to be changed is displayed on the display.
The set value on the sub display (right) will start flashing.

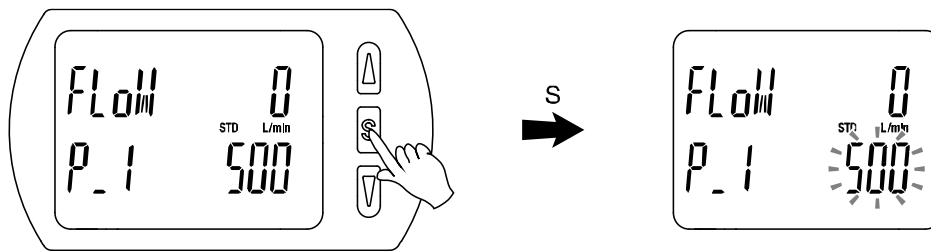

- (2) Press the UP or DOWN button to change the set value.
The UP button is to increase and the DOWN button is to decrease the set value.

- Press the UP button once to increase the value by one digit, press and hold to continuously increase.

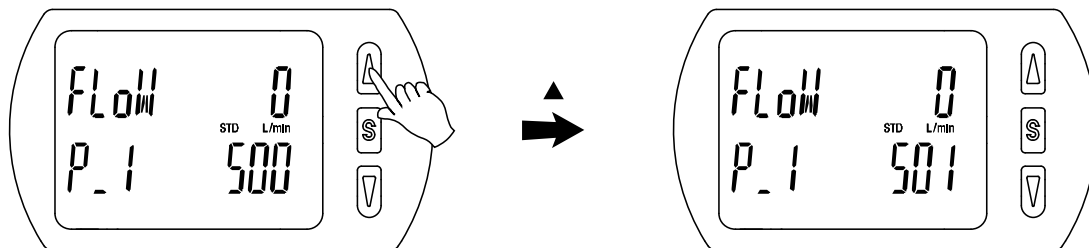

- Press the DOWN button once to reduce the value by one digit, press and hold to continuously reduce.

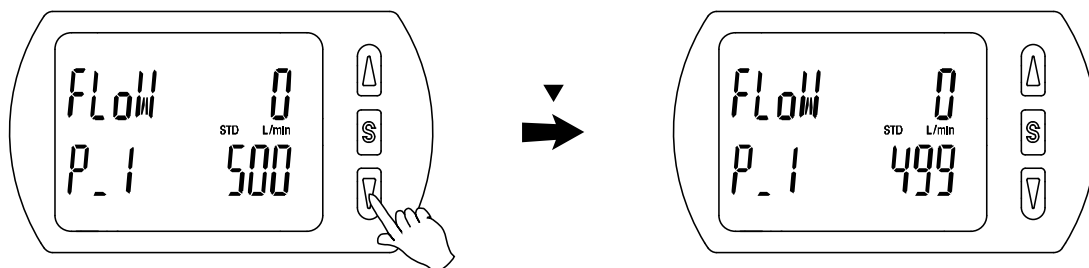

- If the UP and DOWN buttons are pressed simultaneously for 1 second or longer, the set value is displayed as [- - -], and the set value will be the same as the display value automatically (snap shot function) (Refer to page 70). Afterwards, it is possible to adjust the value by pressing UP or DOWN button.

- (3) Press the SET button to complete the setting.

[Window comparator mode]

The Flow switch turns on within a set flow range (from [P1L]/[P2L] to [P1H]/[P2H]).

Set [P1L]/[P2L] (the lower limit of the switch operation), [P1H]/[P2H] (the upper limit of the switch operation) and [WH1]/[WH2] (hysteresis), referring to setting method of page 28)

(When reversed output is selected, the main screen displays [n1L]/[n2L] and [n1H]/[n2H].)

[Accumulated output mode]

Set each [P1]/[P2] (set value), referring to setting method of page 28.

(When reversed output is selected, the main screen displays [n1]/[n2]).

Refer to the "switch output modes" for the relationship between the set values and operation (page 38).

*: Setting of the normal/reverse output switching and hysteresis/window comparator mode/delay time/accumulated output mode switching are performed using the function selection mode [F 1] OUT1 setting and [F 2] OUT2 setting.

Change of Set Flow and Hysteresis [Simple setting mode]

■ Simple setting mode

In the simple setting mode, the set value, hysteresis, and delay time can be changed while checking the current measured value (main display).

<Operation>

[Hysteresis mode]

- (1) Press the SET button for 1 second or longer (but less than 3 seconds) in measurement mode. [SEt] is displayed on the main display.

When the button is released while in the [SEt] display, the current measured value is displayed on the main display, [P_1]/[P_2] or [n_1]/[n_2] is displayed on the sub display (left) and the set value is displayed on the sub display (right).

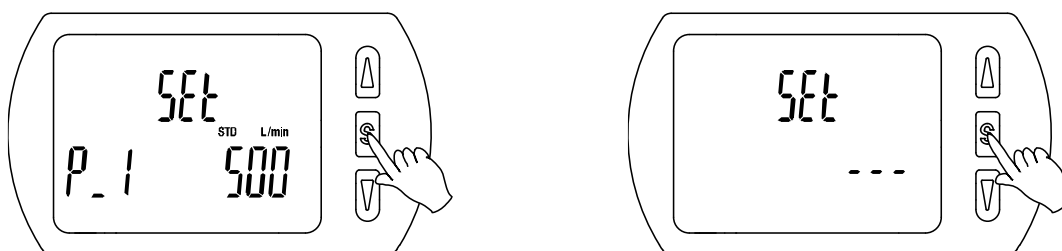

*: When OUT1 and OUT2 are set to accumulated pulse output, error output or output OFF [---] will be displayed in the sub screen when [SEt] is displayed. It is not possible to move to the Simple setting mode.

- (2) Change the set value using the UP or DOWN button, and press the SET button to set the value. Then, the setting moves to hysteresis setting.
(The snap shot function can be used. (Refer to page 70))

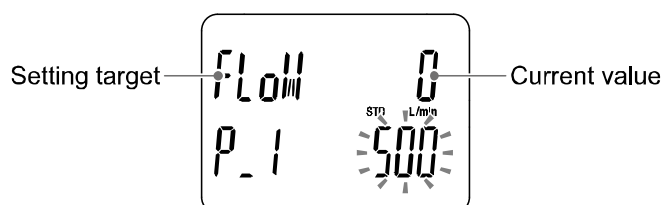

- (3) Change the set value using the UP or DOWN button, and press the SET button to set the value. Then, the setting moves to the setting of OUT2.
(The snap shot function can be used. (Refer to page 70))

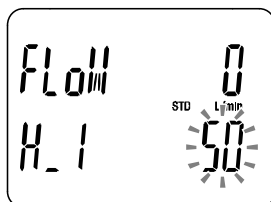

- (4) Like the setting of OUT1, the setting returns to the setting of OUT2 by pressing the SET button after setting the set value and hysteresis.
(5) Press and hold the SET button for 2 seconds or longer to complete the simple setting.
(If the button is pressed for less than 2 seconds, the setting will be returned to [P_1].)

*1: Selected items of (1) to (4) become valid after pressing the SET button.

*2: After enabling the setting by pressing the SET button, it is possible to return to measurement mode by pressing the SET button for 2 seconds or longer.

*3: When the setting target is set to accumulated pulse, error output or output OFF (refer to page 39), the simple setting mode cannot be used. (the setting returns to measurement mode by releasing the button when [SEt] is displayed.)

[Window comparator mode]

Set [P1L]/[P2L] (the lower limit of the switch operation), [P1H]/[P2H] (the upper limit of the switch operation) and [WH1]/[WH2] (hysteresis), referring to setting method of page 28)
(When reversed output is selected, the main screen displays n1L and n1H.)

[Accumulated output mode]

Set each [P1]/[P2] (set value), referring to setting method of page 28.
(When reversed output is selected, the main screen displays [n1]/[n2]).

Refer to the "switch output modes" for the relationship between the set values and operation (page 38).

Change the Function Settings [Function selection mode]

■ Function selection mode

In this mode, each function setting can be changed separately.

In measurement mode, press the SET button for 3 seconds or longer to display [F 0].

Press the UP or DOWN button to select the function to be changed.

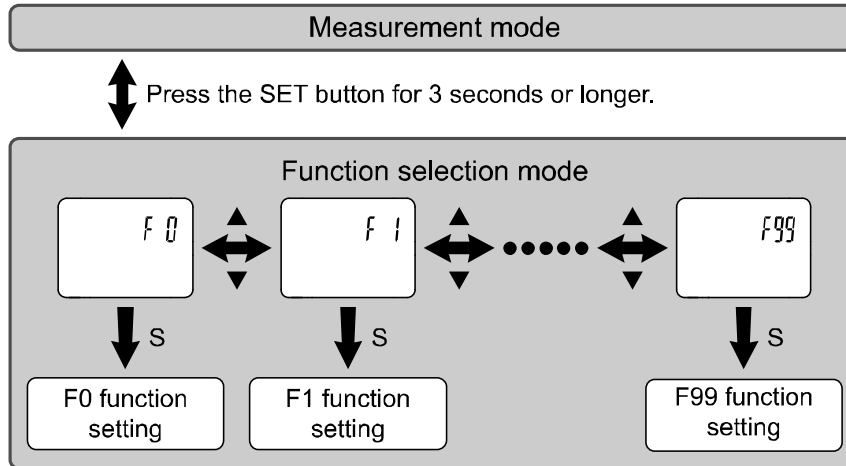

Press the SET button for 2 seconds or longer to return to measurement mode.

■ Default setting

Function		Default Settings Sub display (Right)	Applicable Page	
Main display (Right)	Main display (Left) Sub display (Left)			
[F 0]	FLoW	[rEF] Select display units	[Std] Standard condition	
	FLoW	[Unit] Units selection function *1	[L] L/min	
	tEMP		[C] °C	
	PrES		[MPA] MPa	
	-		[NorP] Select NPN/PNP	[PNP] PNP output
			[oUt1] Select the output of OUT1	[FLoW] Flow rate
			[oUt2] Select the output of OUT2	[FLoW] Flow rate
		[CoL] Select display colour	[1SoG] Green when ON Red when OFF (OUT1)	
[F 1]	oUt1	[SW1] Select the target for setting	[FLoW] Flow rate	
	FLoW	[ModE] Select switch mode	[HYS] Hysteresis mode	
	FLoW	[1ot] Select switch operation	[1_P] Normal output	
	FLoW	[P_1] Input the set value	[500] 500 L/min (PF3A801H) [1000] 1000 L/min (PF3A802H)	
	FLoW	[H_1] Input of hysteresis	[50] 50 L/min (PF3A801H) [100] 100 L/min (PF3A802H)	
	FLoW	[dtH1] ON delay time setting	[0.00] 0 second	
	FLoW	[dtL1] OFF delay time setting	[0.00] 0 second	
[F 2]	oUt2	[SW2] Select the target for setting	[FLoW] Flow rate	
	FLoW	[ModE] Select switch mode	[HYS] Hysteresis mode	
	FLoW	[2ot] Select switch operation	[2_P] Normal output	
	FLoW	[P_2] Input the set value	[500] 500 L/min (PF3A801H) [1000] 1000 L/min (PF3A802H)	
	FLoW	[H_2] Input of hysteresis	[50] 50 L/min (PF3A801H) [100] 100 L/min (PF3A802H)	
	FLoW	[dtH2] ON delay time setting	[0.00] 0 second	
	FLoW	[dtL2] OFF delay time setting	[0.00] 0 second	
[F 3]	FLoW	[FiL] Select digital filter	[1.0] 1 second	
	PrES		[0.10] 0.1 second	
[F 6]	PrES	[FSC] Display value fine adjustment	[0.0] 0%	
[F13]	-	[rEv] Select reverse display	[oFF] Reverse display OFF	
[F14]	FLoW	[cUt] Select Zero cut-off setting	[1.0] 1%F.S. cut	
	PrES		[0.0] 0%	
[F16]	PrES	[MES] Measurement display setting	[diSP] Display	
	tEMP		[diSP] Display	
	AC		[diSP] Display	
[F30]	AC	[SAVe] Accumulated value hold	[oFF] Not stored	
[F80]	-	[diSP] Display OFF mode	[on] Display ON	
[F81]		[Pin]Security code	[oFF] Not used	
[F90]		[ALL] Setting of all functions	[oFF] Not used	
[F96]		[CYCL] Check of cycle time	[- - . -] No input signal	
[F98]		[tESt] Setting of output check	[n] Normal output	
[F99]		[ini] Reset to the default settings	[oFF] Not used	

*1: Setting is only possible for models with the units selection function.

■[F 0] Reference condition/Units selection function/Switch output function/Output object/ Display colour

Reference condition

Standard condition or normal condition can be selected.

Standard condition and normal condition are defined as follows:

- Standard condition: Displayed flow rate which is converted to volume at 20 °C, 101.3 kPa (absolute pressure).
- Normal condition: Displayed flow rate which is converted to volume at 0 °C, 101.3 kPa (absolute pressure).

Units selection function

This setting is only available for models with the units selection function.

*: kPa/MPa can be selected if the product does not have the unit selection function.

Switch output type

The switch output function can be selected (NPN or PNP output).

Output object

Output object can be selected using OUT1 or OUT2.

Display colour

Select the colour of the main display.

<Operation>

Display [F 0] by pressing UP or DOWN button in function selection mode.

Press the SET button. ↓ Move on to reference condition.

Reference condition

Press the UP or DOWN button to select the reference condition.

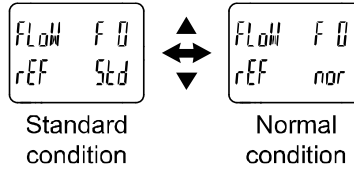

Press the SET button to set. ↓ Move on to units selection function.
(For units selection type)

Units selection function

Press the UP or DOWN button to select the display unit.

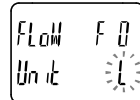

1) Flow rate

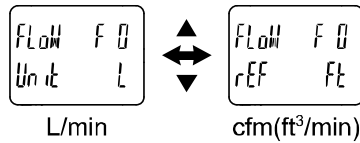

Press the SET button to set. ↓

2) Temperature

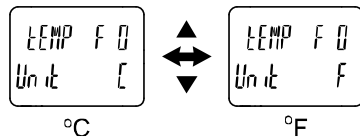

Press the SET button to set. ↓

3) Pressure

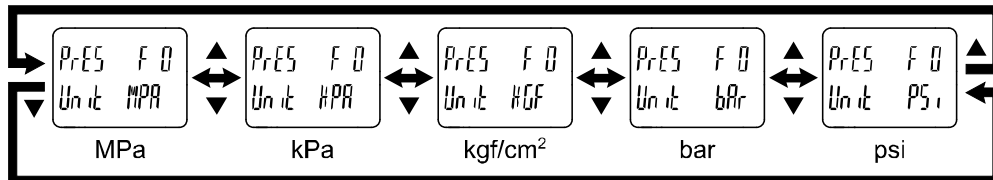

Press the SET button to set. ↓ Move on to switch output function.



Switch output function

Press the UP or DOWN button to select the switch output function.

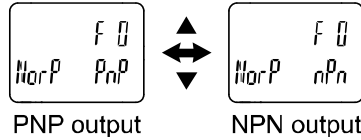
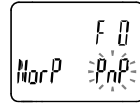

Press the SET button to set. ↓ Move on to the selection of output object.

Output object selection

1) OUT1

Press the UP or DOWN button to select the OUT1 output object.

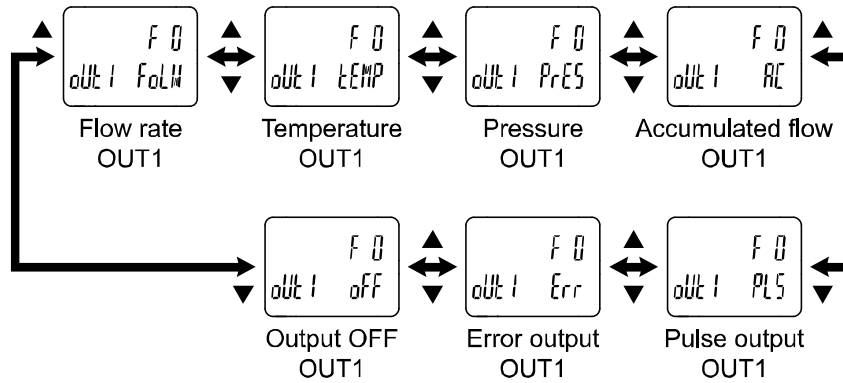
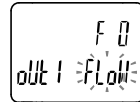

Press the SET button to set. ↓

2) OUT2

Press the UP or DOWN button to select the OUT2 output object.

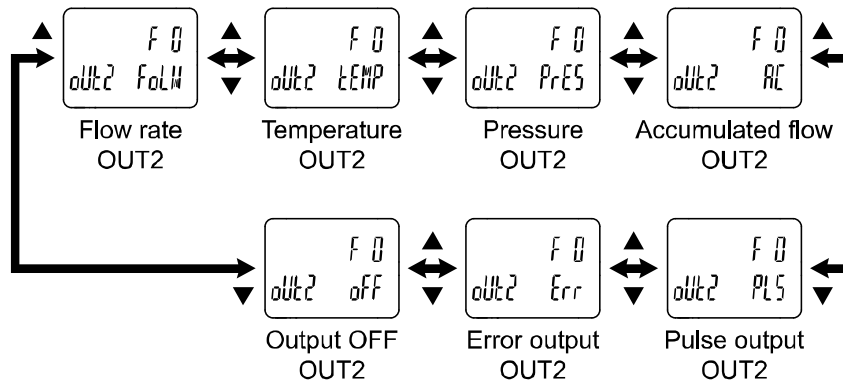

Press the SET button to set. ↓ Move on to select display colour.



Select display colour

Press the UP or DOWN button to select the display colour.

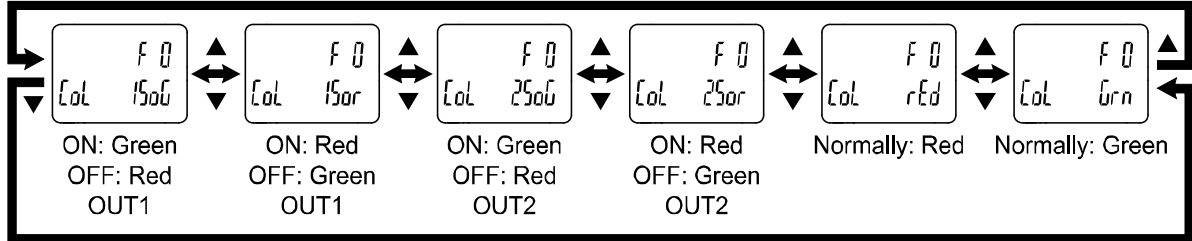
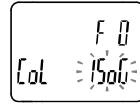

Press the SET button to set. ↓ Return to function selection mode.

[F 0] Reference condition/Units selection function/Switch output function/Output object/Display colour completed

■ [F 1] Setting of OUT1

Set the output mode of OUT1.

● Switch output modes

Select the output mode required from the table below.

	Normal output	Reversed output
Hysteresis mode		
Window comparator mode		
Accumulated output mode (Increment)	<ul style="list-style-type: none"> Count up from "0". Turn ON when the set value is reached. Return to "0" by reset. 	<ul style="list-style-type: none"> Count up from "0". Turn OFF when the set value is reached. Return to "0" by reset.
Accumulated output mode (Decrement)	<ul style="list-style-type: none"> Count down from set value. Turn ON when the "0" is reached. Return to set value by reset. 	<ul style="list-style-type: none"> Count down from set value. Turn OFF when the "0" is reached. Return to set value by reset.
Accumulated pulse output mode		
Error output mode	<p>No error ← → Error status *</p>	<p>No error ← → Error status *</p>
Output OFF mode		

*: The operation may become unstable if hysteresis mode or window comparator mode are used during fluctuating flow conditions. In this case, maintain an interval between the set values and start using after confirming stable operation.

*: Applicable errors are Er1, 2, 6, 8, 10, 12, 15 and 16.

<Operation>

Display [F 1] by pressing UP or DOWN button in function selection mode.

Press the SET button. ↓ Move on to select the target for setting.

Select the target for setting

Press the UP or DOWN button to select the target for setting.

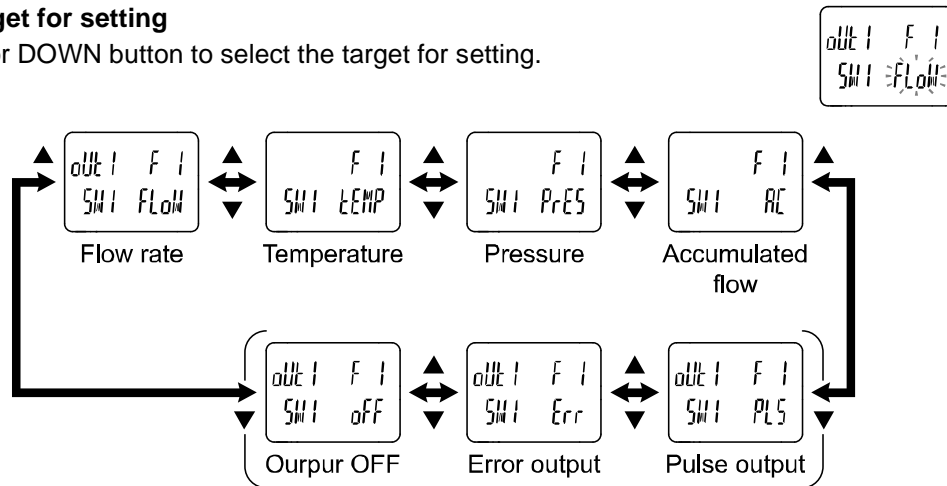

*: [F 0] Only the object selected in OUT1 Output is displayed as OUT1 on the upper left.

*: For Pulse output, error output and output OFF, only the object selected in [F 0] OUT1 Output is displayed.

Press the SET button to set. ↓ Move on to settings.

- a. Flow rate/temperature/pressure is selected: Refer to page 40
- b. Accumulated flow is selected: Refer to page 42
- c. Accumulated pulse output is selected: Refer to page 43
- d. Error output is selected: Refer to page 44
- e. Output OFF is selected: Refer to page 44

Press the SET button to set. ↓ Return to function selection mode.

[F 1] Setting of OUT1 completed

*: Selected item becomes valid after pressing SET button.

*: After enabling the setting by pressing SET button, it is possible to return to the measurement mode by keeping pressing SET button.

a. Flow rate/temperature/pressure is selected

Select output mode

Press the UP or DOWN button to select the output mode.

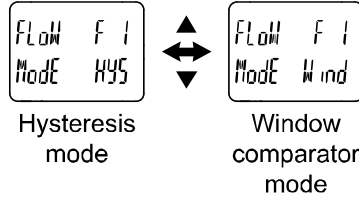

Press the SET button to set. ↓ Move on to the reversed output.

Reversed output setting

Press the UP or DOWN button to select reversed output.

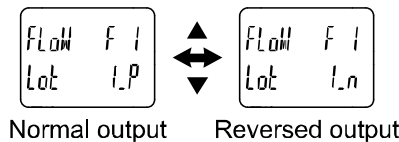
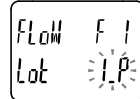

Press the SET button to set. ↓ Move on to setting of set value.

Setting of set value

Set the value based on the setting method on page 28.

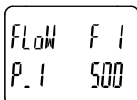
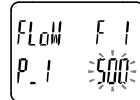

Set value

Hysteresis mode: [P_1]
 Window comparator mode: [P1L] [P1H]
 "P" is changed to "n" as [P_1] → [n_1] when reversed output is selected
 The snap shot function can still be used.

Press the SET button to set. ↓ Move on to setting of hysteresis.

Setting of hysteresis

Set the value based on the setting method on page 28.

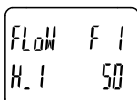
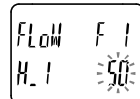

Hysteresis

Hysteresis mode: [H_1]
 Window comparator mode: [WH1]
 The snap shot function can still be used.

Press the SET button to set. ↓ Move on to the ON delay time input.



ON delay time input

Press the UP or DOWN button to set the ON delay time.

ON delay time set range: 0.00 to 60.00 [s]

FLow F 1
dtH 000

FLow F 1
dtH 000

ON delay time

Press the SET button to set. ↓ Move on to the OFF delay time input.

OFF delay time input

Press the UP or DOWN button to set the OFF delay time.

OFF delay time set range: 0.00 to 60.00 [s]

FLow F 1
dtL 000

FLow F 1
dtL 000

OFF delay time

Press the SET button to set. ↓ Return to function selection mode.

[F 1] Setting of OUT1 completed

b. Accumulated flow is selected

Reversed output setting

Press the UP or DOWN button to select reversed output.

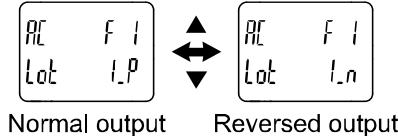
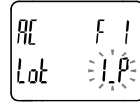

Press the SET button to set. Move on to the accumulated increment (addition)/decrement (subtraction).

Select accumulated increment (addition) or decrement (subtraction)

Press the UP or DOWN button to select the accumulated increment (addition)/decrement (subtraction).

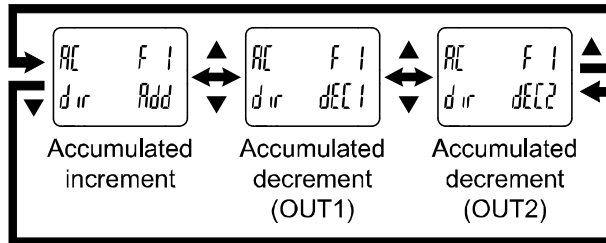
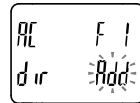

*: For Accumulated decrement, OUT1 or OUT2 is displayed.
The switch output can be set individually.

Press the SET button to set. Move on to setting of set value.

Setting of set value

Press the UP or DOWN button to change the value.
Press the SET button to move to the digit to the right.
Press the SET button for 1 second or longer to flash all digits.
Press the SET button while all the digits are flashing to move to the next step.

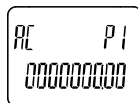
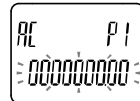

Set value

The accumulated output setting range is displayed by the set value of the 9 digits and the units ($\times 10^3$ L).

Press the SET button to set. Return to function selection mode.

[F 1] Setting of OUT1 completed

c. Accumulated pulse output is selected

Reversed output setting

Press the UP or DOWN button to select reversed output.

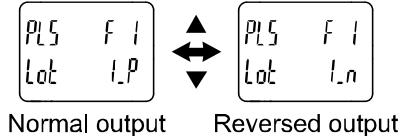
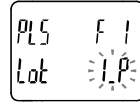

Press the SET button to set.  Move on to setting of accumulated pulse output value.

Select accumulated pulse output

Press the UP or DOWN button to select accumulated pulse output.

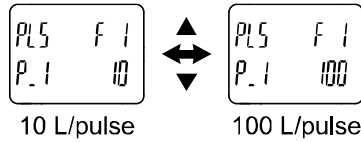
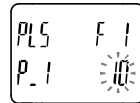

Press the SET button to set.  Return to function selection mode.

[F 1] Setting of OUT1 completed

d. Error output is selected

Reversed output setting

Press the UP or DOWN button to select reversed output.

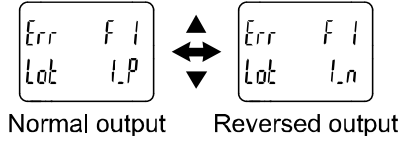
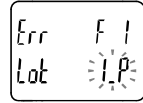

Press the SET button to set. ↓ Return to function selection mode.

[F 1] Setting of OUT1 completed

e. Output OFF is selected

Press the SET button to return to function selection mode.

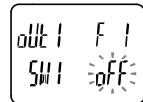

[F 1] Setting of OUT1 completed

■[F 2] Setting of OUT2

Set the output mode of OUT2.

<Operation>

Display [F 2] by pressing UP or DOWN button in function selection mode.

Press the SET button. ↓

[F 1] Set the output based on the setting of OUT1.

*: The part displayed as "1" in the OUT1 setting is displayed as "2" in the OUT2 setting.

■ [F 3] Select digital filter

The digital filter can be selected to filter the flow rate and pressure measurement.
Output chattering or display flicker in measurement mode can be reduced by setting the digital filter.

<Operation>

Display [F 3] by pressing UP or DOWN button in function selection mode.

Press the SET button. ↓ Move on to select digital filter (flow rate).

Select digital filter (flow rate)

Press the UP or DOWN button to select the flow rate digital filter.

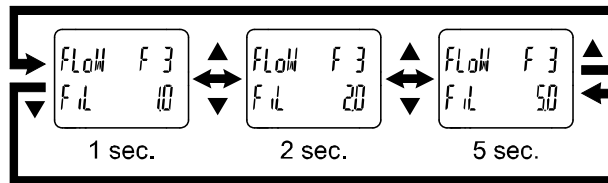

Press the SET button to set. ↓ Move on to select digital filter (pressure).

Select digital filter (pressure)

Press the UP or DOWN button to select the pressure digital filter.

Digital filter set range: 0.00 to 30.00 [s]

0 to 30 sec.

Press the SET button to set. ↓ Return to function selection mode.

[F 3] Digital filter setting completed

*: Each set value is a guideline for 90% response time.

*: Both the switch output and flow display are affected.

■[F 6] Fine adjustment of display value

This function is to manually perform a fine adjustment of the displayed pressure value.
Pressure can be adjusted in the following range of $\pm 5\%$ R.D.

<Operation>

Display [F 6] by pressing UP or DOWN button in function selection mode.

Press the SET button. ↓ Move on to fine adjustment of display value.

Select digital filter (flow rate)

Press the UP or DOWN button to change adjustment rate.

When adjustment rate is changed, the pressure value after the adjustment will be displayed on the main screen.

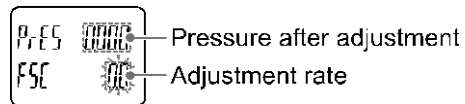

Press the SET button to set. ↓ Return to function selection mode.

[F 6] Fine adjustment of display value completed

■[F13] Setting for reverse display mode

This function is used to rotate display upside down.

It is used to correct the display when it is upside down due to installation of the product.

When the reverse display function is ON, the function of the UP/DOWN buttons are reversed.

<Operation>

Display [F13] by pressing UP or DOWN button in function selection mode.

Press the SET button. ↓ Move on to select reverse display.

Select reverse display

Press the UP or DOWN button to select reverse display.

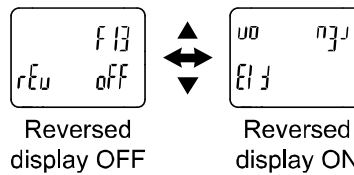
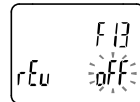

Press the SET button to set. ↓ Return to function selection mode.

[F13] Setting for reverse display mode completed

*: When reverse display function is ON, the characters of the sub display appear upside down.

■[F14] Zero cut-off setting

When the flow rate and pressure is close to zero, this function forces the display to zero.
The zero cut-off range is 0.0 to 10.0%F.S., and can be set in 1.0%F.S. increments.

< Operation >

Display [F14] by pressing UP or DOWN button in function selection mode.

Press the SET button. ↓ Move on to select zero cut-off setting (flow rate).

Select zero cut-off setting (flow rate)

Press the UP or DOWN button to select the value of zero cut-off.

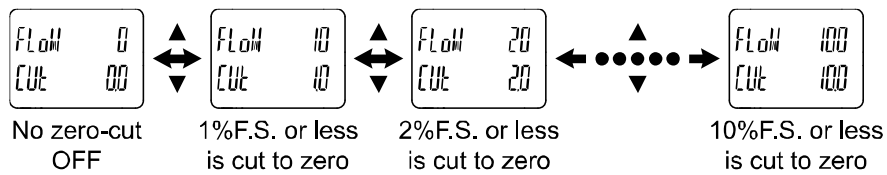

*: The display above is an example of when [L] is selected for the PF3A801H (1000 L/min type) with the unit switching function.

*: If the flow rate does not reach the above value, the display will be zero.

Example: PF3A801H (1000 L/min type)

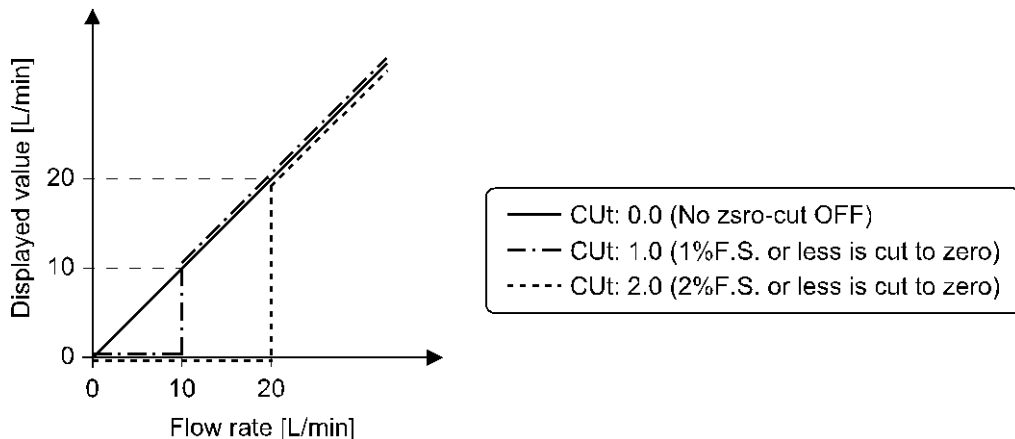

Press the SET button to set. ↓ Move on to select zero cut-off setting (pressure).

Select zero cut-off setting (pressure)

Press the UP or DOWN button to select the value of Zero cut-off.

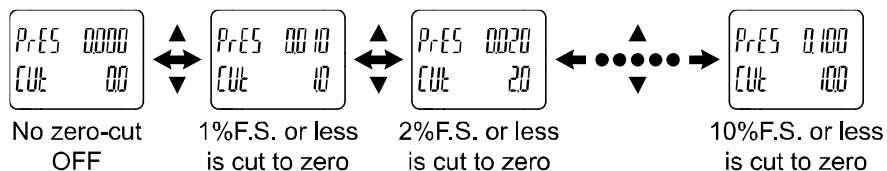

*: When the actual value is smaller than the displayed value in the upper line, zero will be displayed.

Press the SET button to set. ↓ Return to function selection mode.

[F14] Zero cut-off setting completed

●Set flow rate range

Zero cut-off set value	Zero cut-off range	Displayable flow range	
		PF3A801H	PF3A802H
0.0 *	0%F.S.	0 to 1050 L/min	0 to 2100 L/min
1.0	0 to 1%F.S.	10 to 1050 L/min (Displays 0 when the value is below 10 L/min)	20 to 2100 L/min (Displays 0 when the value is below 20 L/min)
2.0	0 to 2%F.S.	20 to 1050 L/min (Displays 0 when the value is below 20 L/min)	40 to 2100 L/min (Displays 0 when the value is below 40 L/min)
3.0	0 to 3%F.S.	30 to 1050 L/min (Displays 0 when the value is below 30 L/min)	60 to 2100 L/min (Displays 0 when the value is below 60 L/min)
4.0	0 to 4%F.S.	40 to 1050 L/min (Displays 0 when the value is below 40 L/min)	80 to 2100 L/min (Displays 0 when the value is below 80 L/min)
5.0	0 to 5%F.S.	50 to 1050 L/min (Displays 0 when the value is below 50 L/min)	100 to 2100 L/min (Displays 0 when the value is below 100 L/min)
6.0	0 to 6%F.S.	60 to 1050 L/min (Displays 0 when the value is below 60 L/min)	120 to 2100 L/min (Displays 0 when the value is below 120 L/min)
7.0	0 to 7%F.S.	70 to 1050 L/min (Displays 0 when the value is below 70 L/min)	140 to 2100 L/min (Displays 0 when the value is below 140 L/min)
8.0	0 to 8%F.S.	80 to 1050 L/min (Displays 0 when the value is below 80 L/min)	160 to 2100 L/min (Displays 0 when the value is below 160 L/min)
9.0	0 to 9%F.S.	90 to 1050 L/min (Displays 0 when the value is below 90 L/min)	180 to 2100 L/min (Displays 0 when the value is below 180 L/min)
10.0	0 to 10%F.S.	100 to 1050 L/min (Displays 0 when the value is below 100 L/min)	200 to 2100 L/min (Displays 0 when the value is below 200 L/min)

*: The zero-cut range of the accumulated value and accumulated pulse value should be 1%F.S. or more. However, please note that if the zero-cut set value is 0.0, any value below 1%F.S. will be cut.

*: When setting the flow value and hysteresis within zero cut-off settable range, the on-off point varies depending on the settable range. For details, please refer to the "When the set value and hysteresis of the switch output (OUT1/OUT2) is set within the zero-cut range (page 52)".

●Set pressure range

Zero cut-off set value	Zero cut-off range	Displayable pressure range
0.0	0%F.S.	-0.050 to 1.050 MPa
1.0	0 to 1%F.S.	-0.050 to -0.010 MPa 0.010 to 1.050 MPa (Displays 0 when the value is -0.009 to 0.009 MPa)
2.0	0 to 2%F.S.	-0.050 to -0.020 MPa 0.020 to 1.050 MPa (Displays 0 when the value is -0.019 to 0.019 MPa)
3.0	0 to 3%F.S.	-0.050 to -0.030 MPa 0.030 to 1.050 MPa (Displays 0 when the value is -0.029 to 0.029 MPa)
4.0	0 to 4%F.S.	-0.050 to -0.040 MPa 0.040 to 1.050 MPa (Displays 0 when the value is -0.039 to 0.039 MPa)
5.0	0 to 5%F.S.	-0.050 MPa 0.050 to 1.050 MPa (Displays 0 when the value is -0.049 to 0.049 MPa)
6.0	0 to 6%F.S.	0.060 to 1.050 MPa (Displays 0 when the value is below 0.060 MPa)
7.0	0 to 7%F.S.	0.070 to 1.050 MPa (Displays 0 when the value is below 0.070 MPa)
8.0	0 to 8%F.S.	0.080 to 1.050 MPa (Displays 0 when the value is below 0.080 MPa)
9.0	0 to 9%F.S.	0.090 to 1.050 MPa (Displays 0 when the value is below 0.090 MPa)
10.0	0 to 10%F.S.	0.100 to 1.050 MPa (Displays 0 when the value is below 0.100 MPa)

- When the set value and hysteresis of the switch output (OUT1/OUT2) is set within the zero-cut range. The operating point of the switch output will be changed, depending on the zero-cut setting value. However, please note that the set value and hysteresis of the switch output will not be changed. To maintain the on-off point, set the value and hysteresis without the zero cut-off range.

<Example: PF3A801H (1000 L/min type)>

Common setting

Output mode	Hysteresis mode
Switch operation	Normal output
Set value (P)	25
Hysteresis (H)	10

Initial setting

Zero cut-off setting CUT: 1.0 (displays 0 for a value below 10 L/min)

Switch ON point	25 L/min or more
Switch OFF point	Below 15 L/min

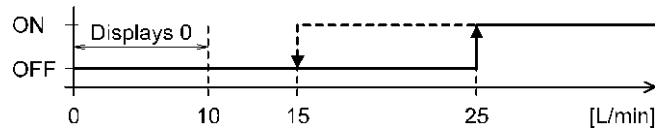

Change the zero cut-off setting
The set value (P) and hysteresis (H)
cannot be changed.

~Condition when the operating point of hysteresis (H) is changed~

- The zero-cut setting CUT: 1.0 will be changed to CUT: 2.0. (0 will be displayed for a value below 20 L/min)

Switch ON point	25 L/min or more
Switch OFF point	Below 20 L/min (0 is displayed)

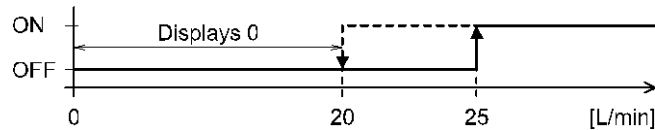

~Condition when the operating point of the set point (P) and hysteresis (H) is changed~

- The zero-cut setting CUT: 1.0 will be changed to CUT: 3.0. (0 will be displayed for a value below 30 L/min)

Switch ON point	30 L/min or more
Switch OFF point	Below 30 L/min (0 is displayed)

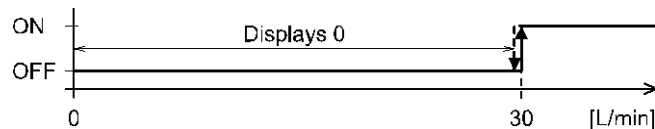

■[F16] Measurement display setting

Display/hide the measured accumulated flow rate, pressure, and temperature can be set.

<Operation>

Display [F16] by pressing UP or DOWN button in function selection mode.

Press the SET button. ↓ Move on to measurement display setting.

Measurement display setting

Press the UP or DOWN button to select the measurement display setting.

1) Pressure

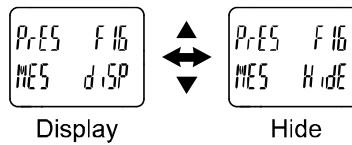

Press the SET button to set. ↓

2) Temperature

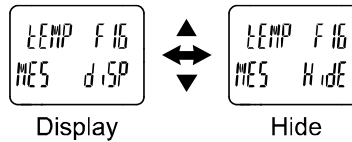

Press the SET button to set. ↓

3) Accumulated flow

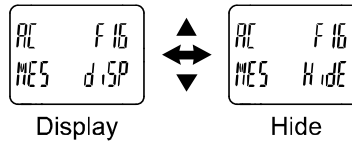

Press the SET button to set. ↓ Return to function selection mode.

[F16] Setting of measurement display completed

*: When the temperature is set to "hide" and the integrated flow rate is set to "display", the maximum number of display digits for the accumulated flow rate is 9 digits.

■[F30] Setting of accumulated value hold

In the default setting, the accumulated flow value is not held when the power supply is turned off. This function enables the accumulated flow value to be stored in permanent memory every 2 or 5 minutes.

*: When using the accumulated value hold function, calculate the product life from the operating conditions, and use the product within its life. Maximum updating time of the accumulated value is 1.5 million times.

If the product is operated 24 hours per day, the product life will be as follows.

- Data memorized every 5 minutes: 5 minutes x 1.5 million times = 7.5 million minutes = 14.3 years
- Data memorized every 2 minutes: 2 minutes x 1.5 million times = 3 million minutes = 5.7 years

If the Accumulated Flow External Reset is repeatedly used, the product life will be shorter than calculated life.

<Operation>

Display [F30] by pressing UP or DOWN button in function selection mode.

Press the SET button. ↓ Move on to select accumulated value hold.

Select accumulated value hold

Press the UP or DOWN button to select the accumulate value hold.

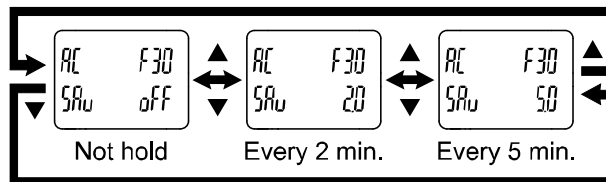
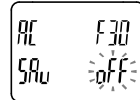

Press the SET button to set. ↓ Return to function selection mode.

[F30] Setting of accumulated value hold completed

*: The value is stored in memory every 2 or 5 minutes. If the power supply is turned off, the accumulated flow since the last time it was stored will be lost.

*: When the power supply is turned on again, the accumulated flow count will start from the last value recorded at B.

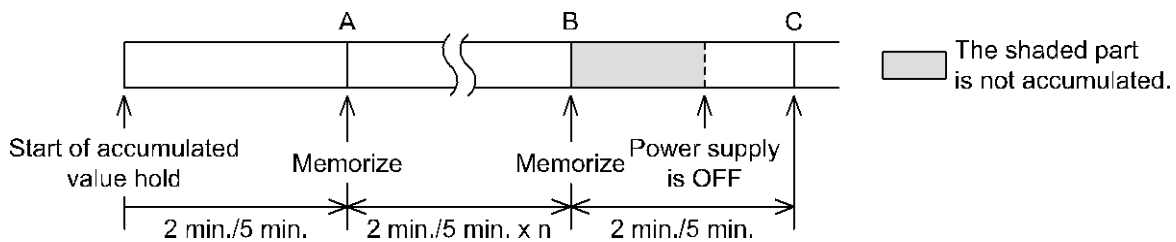

■[F80] Set display OFF mode

This function will turn the display OFF if no buttons are pressed for 30 seconds.

<Operation>

Display [F80] by pressing UP or DOWN button in function selection mode.

Press the SET button. ↓ Move on to select display OFF mode.

Select display OFF mode

Press the UP or DOWN button to select display OFF function.

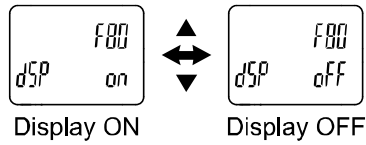

Press the SET button to set. ↓ Return to function selection mode.

[F80] Setting of display OFF mode completed

*: In display OFF mode, the under bar of sub display flashes.

*: When any button is activated, the display will turn on. If no button operation is performed within 30 seconds, the display will turn off again.



■[F81] Security code

The security code can be turned on and off and the security code can be changed when unlocked.

< Operation >

Display [F81] by pressing UP or DOWN button in function selection mode.

Press the SET button. ↓ Move on to select security code.

Select security code

Press the UP or DOWN button to select security code.

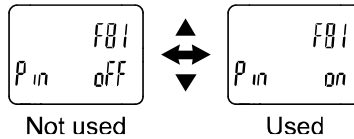
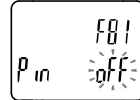

[OFF] is selected.
Press the SET button to
return to function
selection mode.

[ON] is selected.
Press the SET button to set. ↓ Move on to check of the
setting of security code.

Check of the setting of security code

Press the UP or DOWN button to change
the value.

Press the SET button to move to the digit
to the right.

(The default setting is [000])

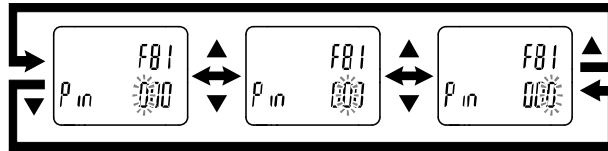

Press the SET button for 1 second or longer.

- When the security code is correct, move on to the security code setting.
- If the security code entered is incorrect, [FAL] will be displayed, and the security code must be entered again.

If the wrong security code is entered 3 times, [nG] is displayed on the main display and the device returns to function selection mode.

↓ Move on to the setting of security code.

Changing of security code.

New security code is displayed on the main display.
Press the UP or DOWN button to change the value.
Press the SET button to move on to input the next digit.

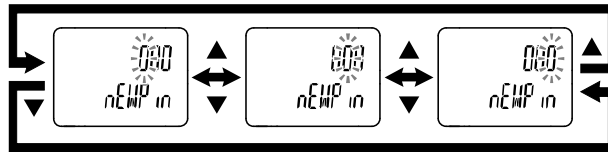

After entry, the changed security code will flash by pressing the SET button for 1 second or longer.
(At this point, the changing of the security code is not completed)
Press the UP or DOWN button to return to setting step.



Press the SET button to set. ↓ Return to function selection mode.

[F81] Setting of security code completed

If the security code function is enabled, it is necessary to input a security code to release the key lock.
*: If a key is not pressed for 30 seconds while entering the security code, function selection mode will return.

■[F90] Setting of all functions

Each time the SET button is pressed, the function steps in the order shown in the following table.

<Operation>

Display [F90] by pressing UP or DOWN button in function selection mode.

Press the SET button. ↓ Move on to the suction signal input check.

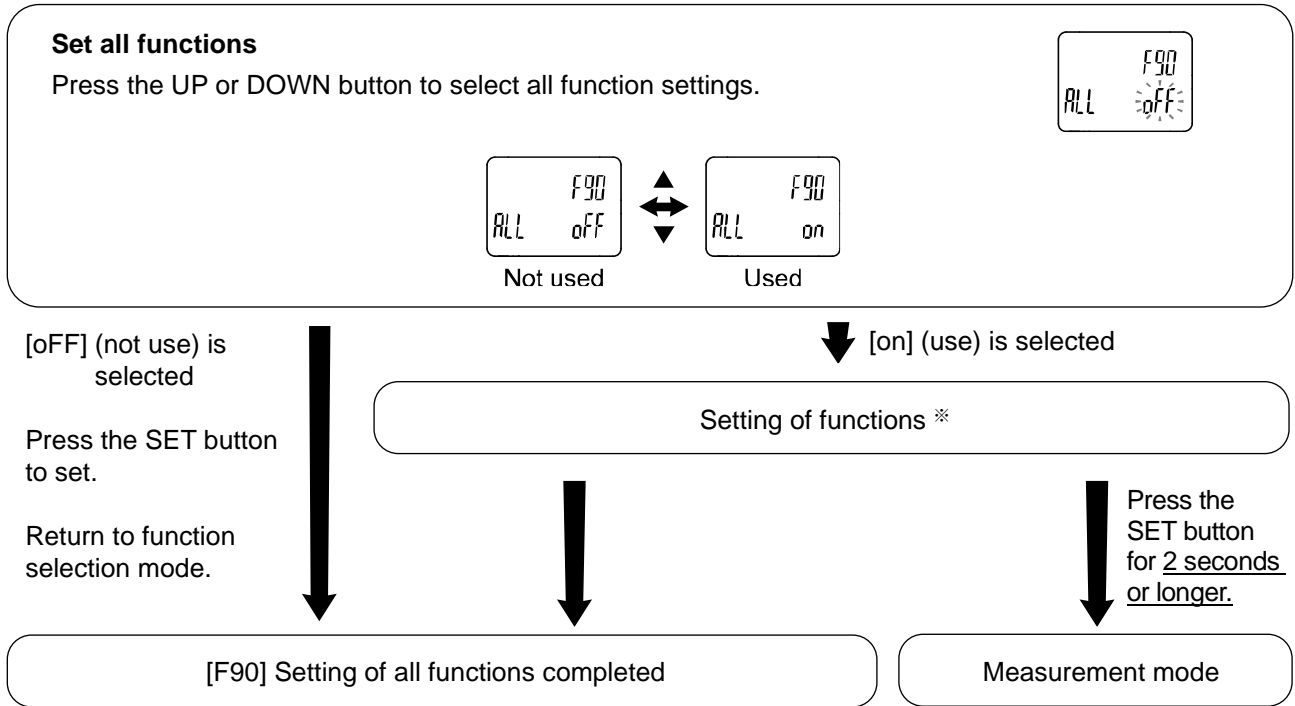

*: Setting of each function

Every time the SET button is pressed, the display moves to the next function in "Order of function settings" on page 59.

Set by pressing UP and DOWN button.

For details of how to set each function, refer to the relevant setting of function section in this manual.

Order of function settings

Order	Function	Applicable model
[F 0]	Reference condition	All models
	Unit selection function	Model with units selection function
	Switch output function	All models
	Output object selection	All models
	Select display colour	All models
[F 1]	OUT1 output mode	All models (when flow rate, temperature and pressure settings are selected)
	Select the reversed output of OUT1	All models (When setting mode is selected, except output OFF mode)
	Selection of accumulated increment or decrement of OUT1	All models (when accumulated flow rate is selected)
	OUT1 set value	All models (When setting mode is selected, except error output and output OFF mode)
	OUT1 hysteresis	All models (when flow rate, temperature and pressure settings are selected)
	OUT1 delay time	All models (when flow rate, temperature and pressure settings are selected)
[F 2]	OUT2 output mode	All models (when flow rate, temperature and pressure settings are selected)
	Select the reversed output of OUT2	All models (When setting mode is selected, except output OFF mode)
	Selection of accumulated increment or decrement of OUT2	All models (when accumulated flow rate is selected)
	OUT2 set value	All models (When setting mode is selected, except error output and output OFF mode)
	OUT2 hysteresis	All models (when flow rate, temperature and pressure settings are selected)
	OUT2 delay time	All models (when flow rate, temperature and pressure settings are selected)
[F 3]	Select response time	All models
[F13]	Select reverse display	All models
[F14]	Select zero cut-off setting	All models
[F16]	Measurement display setting	All models
[F30]	Select accumulated value hold	All models
[F80]	Setting of display OFF mode	All models
[F81]	Setting of Security code	All models

■[F96] Check of cycle time

The average cycle time during IO-Link communication can be checked.

*: If switch output is selected, the cycle time cannot be checked.

<Operation>

Display [F96] by pressing UP or DOWN button in function selection mode.

Press the SET button. ↓ Move on to check of cycle time.

Check of cycle time

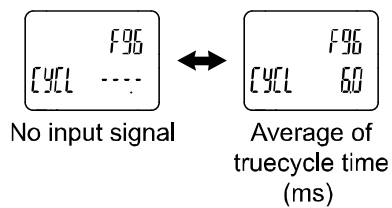

Press the SET button to set. ↓ Return to function selection mode.

[F96] Setting of check of cycle time completed

■[F98] Setting of output check

By forcibly switching the output ON / OFF operation by the button operation, the operation of the system can be checked regardless of the measured value.

<Operation>

Display [F98] by pressing UP or DOWN button in function selection mode.

Press the SET button. ↓ Move on to select of output check.

Select of output check

Press the UP or DOWN button to select the output check.

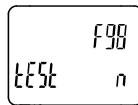

Normal output (Output not checked) Forced output (Output is checked)

[n] (Normal output) is selected.

Press the SET button to set.

Return to function selection mode.

[F] (Forced output) is selected. ↓ Move on to output check of OUT1.

Output check of OUT1

Press the UP or DOWN button to select output check of OUT1.

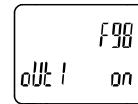
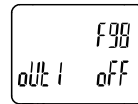
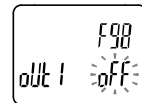

Forced output OFF Forced output ON

Press the SET button to set. ↓ Move on to output check of OUT2.

Output check of OUT2

Press the UP or DOWN button to select output check of OUT2.

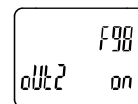
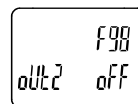
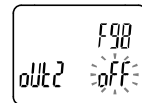

Forced output OFF Forced output ON

[F 0] When accumulated pulse output is selected for (OUT1). Press the SET button to set. ↓ Move on to pulse output check of OUT1.



Check of OUT1 accumulated pulse output

Accumulated pulse is output for 10 times by pressing the UP button. Accumulated pulse conversion value is cleared and stopped by pressing the DOWN button.

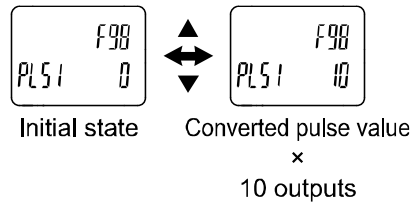
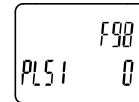

*: When the converted pulse value is 10 L/pulse, the value is changed between 0 and 100 by pressing the UP button once (total of 10 times of output). If the UP button is pressed again, the value is changed to 100 to 200.

[F 0] When accumulated pulse output is selected for (OUT2). Press the SET button to set.



Move on to pulse output check of OUT2.

Check of OUT2 accumulated pulse output

Accumulated pulse is output for 10 times by pressing the UP button. Accumulated pulse conversion value is cleared and stopped by pressing the DOWN button.

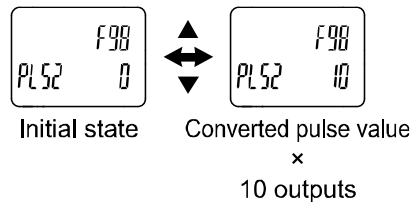
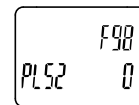

*: When the converted pulse value is 10 L/pulse, the value is changed between 0 and 100 by pressing the UP button once (total of 10 times of output). If the UP button is pressed again, the value is changed to 100 to 200.

When the product is used in SDCI mode (IO-Link) Press the SET button to set.



Move on to PD Accumulated SW1 bit check.

PD Accumulated SW1 bit check

Select the accumulated SW1 bit check by pressing the UP or DOWN button.

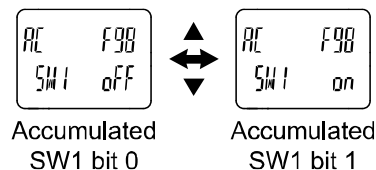
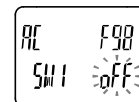

*: This function is available with IO-Link communication.

Press the SET button to set.



Move on to PD Accumulated SW2 bit check.



PD Accumulated SW2 bit check

Select the accumulated SW2 bit check by pressing the UP or DOWN button.

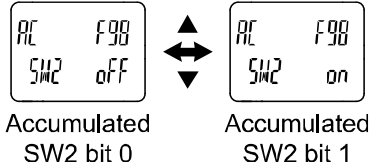

*: This function is available with IO-Link communication.

Press the SET button to set. Move on to PD Flow rate SW1 bit check.

PD Flow rate SW1 bit check

Select the flow rate SW1 bit check by pressing the UP or DOWN button.

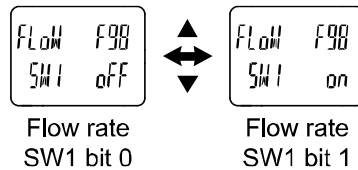
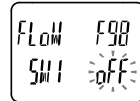

*: This function is available with IO-Link communication.

Press the SET button to set. Move on to PD Flow rate SW2 bit check.

PD Flow rate SW2 bit check

Select the flow rate SW2 bit check by pressing the UP or DOWN button.

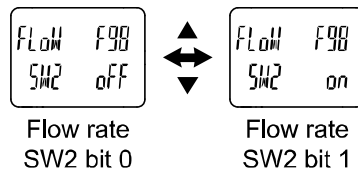
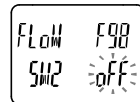

*: This function is available with IO-Link communication.

Press the SET button to set. Move on to PD Temperature SW1 bit check.

PD Temperature SW1 bit check

Select the temperature SW1 bit check by pressing the UP or DOWN button.

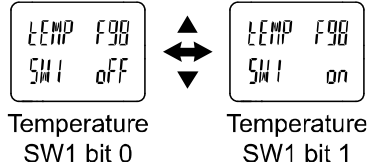

*: This function is available with IO-Link communication.

Press the SET button to set. ↓ Move on to PD Temperature SW2 bit check.

PD Temperature SW2 bit check

Select the SW2 bit check by pressing the UP or DOWN button.

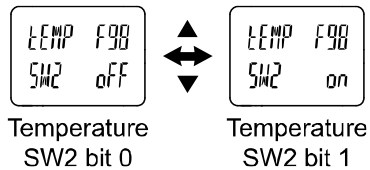

*: This function is available with IO-Link communication.

Press the SET button to set. ↓ Move on to PD Pressure SW1 bit check.

PD Pressure SW1 bit check

Select pressure SW1 bit check by pressing the UP or DOWN button.

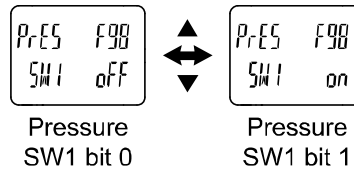

*: This function is available with IO-Link communication.

Press the SET button to set. ↓ Move on to PD Pressure SW2 bit check.

PD Pressure SW2 bit check

Select pressure SW2 bit check by pressing the UP or DOWN button.

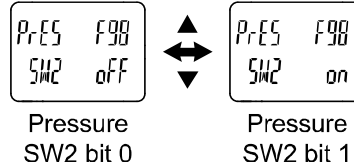

*: This function is available with IO-Link communication.

Press the SET button to set. ↓ Move on to PD Flow rate unit bit check.

PD Flow rate unit bit check

Select the flow rate unit bit check by pressing the UP or DOWN button.

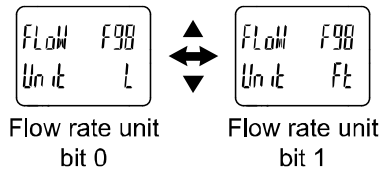

*: This function is available with IO-Link communication.

Press the SET button to set. ↓ Move on to PD Flow rate criteria bit check.

PD Flow rate criteria bit check

Select the flow rate criteria bit check by pressing the UP or DOWN button.

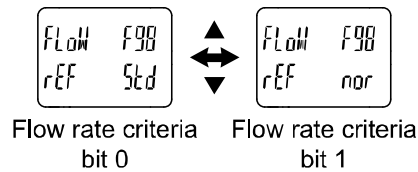

*: This function is available with IO-Link communication.

Press the SET button to set. ↓ Move on to PD Flow rate diagnosis bit check.

PD Flow rate diagnosis bit check

Select the flow rate diagnosis bit check by pressing the UP or DOWN button.

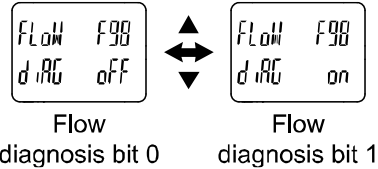

- *: This function is available with IO-Link communication.
- *: For details of the diagnosis information refer to page 75.

Press the SET button to set. Move on to PD Temperature diagnosis bit check.

PD Temperature diagnosis bit check

Select the temperature diagnostic bit check by pressing the UP or DOWN button.

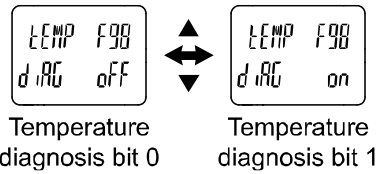

- *: This function is available with IO-Link communication.
- *: For details of the diagnosis information refer to page 75.

Press the SET button to set. Move on to PD Pressure diagnosis bit check.

PD Pressure diagnosis bit check

Select the Pressure diagnosis bit check by pressing the UP or DOWN button.

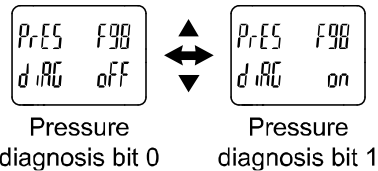

- *: This function is available with IO-Link communication.
- *: For details of the diagnosis information refer to page 75.

Press the SET button to set. Move on to PD Error diagnosis bit check.

PD Error diagnosis bit check

Select the Error diagnosis bit check by pressing the UP or DOWN button.

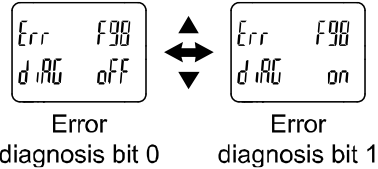

- *: This function is available with IO-Link communication.
- *: For details of the diagnosis information refer to page 75.

Press the SET button to set. ↓ Move on to PD System error diagnosis bit check.

PD System error diagnosis bit check

Select the System error diagnosis bit check by pressing the UP or DOWN button.

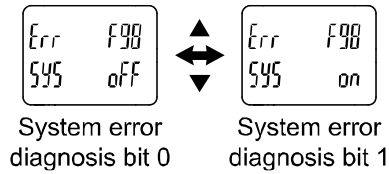

- *: This function is available with IO-Link communication.
- *: For details of the diagnosis information refer to page 75.

Press the SET button to set. ↓ Move on to PD Accumulated value check.

PD Accumulated value check

Press the UP or DOWN button to select the accumulate value check.

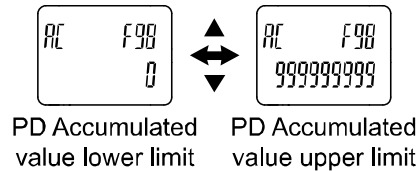

- *: This function is available with IO-Link communication.

Press the SET button to set. ↓ Move on to PD Flow rate check.

PD Flow rate check

Press the UP or DOWN button to select the flow rate check.

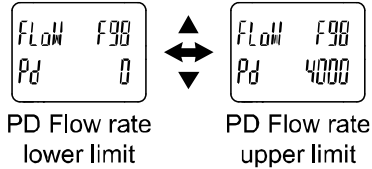
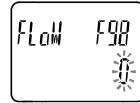

*: This function is available with IO-Link communication.

Press the SET button to set. ↓ Move on to PD Temperature check.

PD Temperature check

Press the UP or DOWN button to select the temperature check.

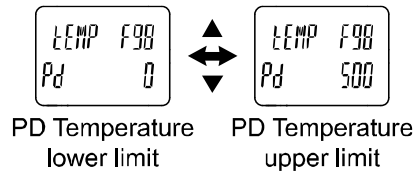
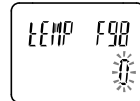

*: This function is available with IO-Link communication.

Press the SET button to set. ↓ Move on to PD Pressure check.

PD Pressure check

Press the UP or DOWN button to select the pressure check.

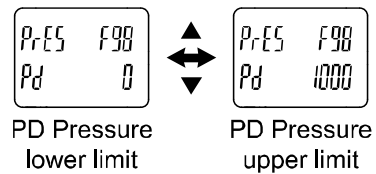

*: This function is available with IO-Link communication.

Press the SET button to set. ↓ Return to function selection mode.

[F98] Setting of output check completed

*: Measurement mode can return from any setting item by pressing the SET button for 2 seconds or longer.

*: An increase or decrease in flow rate, temperature or pressure will have no effect on the output while the output operation is being performed.

*: PD stands for Process data. Refer to page 75 for further details.

■[F99] Reset to the default settings

If the Flow switch settings are uncertain, the default values can be restored.

<Operation>

Display [F99] by pressing UP or DOWN button in function selection mode.

Press the SET button. ↓ Move on to reset to factory default settings.

Rest to factory default settings.

Press the UP or DOWN button to display [ON], then press SET and DOWN buttons simultaneously for 5 seconds or longer.

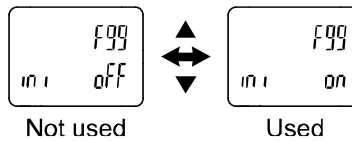
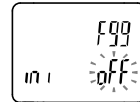

[oFF] (not use) is selected
Press the SET button to set.
Return to function selection mode.

All settings are returned to the default values.
Return to function selection mode.

[F99] Reset to the default settings completed

Other Settings

- Reset operation

The Accumulated Flow, Peak Value, and Bottom Value can be reset.

To reset the accumulated value, press the DOWN and SET buttons for 1 second or longer.

Resetting the accumulated flow is possible only when the accumulated flow is displayed.

Resetting the peak value and bottom value is effective for the measurement target displayed in the peak display or bottom display.

- Snap shot function

The current measured value can be stored to the switch output ON/OFF set point.

When the items on the Sub display (left) are selected in either 3 step setting mode, Simple setting mode or Setting of each function mode, by pressing the UP and DOWN buttons simultaneously for 1 second or longer, the value of the sub display (right) will show [- - -], and the values corresponding to the current measured value are automatically displayed.

Output mode	Configurable items	Sub display (left)	Snap shot function
Hysteresis mode	OUT set value	P_1 (n_1), P_2 (n_2)	○
	Hysteresis	H_1, H_2	○
Window comparator mode	OUT set value	P1L (n1L), P1H (n1H) P2L (n2L), P2H (n2H)	○
	Hysteresis	WH1, WH2	×

- OUT set value

The value is set to the same value as the display value (current measured value).

(There is a range which cannot be set to the current flow rate depending on the hysteresis difference. In that case, the value is set to the closest value.)

- Hysteresis

The hysteresis is calculated from the equation below and set.

Normal output: (OUT set value)-(current measured value)

Reverse output: (current measured value)-(OUT set value)

If the calculation result becomes 0 or less, [Err] is displayed on the sub display and the set value is not changed.

Afterwards, it is possible to adjust the value by pressing UP or DOWN button.

- Display select function

The number of accumulated flow rate display digits can be temporarily switched when the temperature and accumulated flow rate are set in the measurement display settings.

The normal accumulated display consists of the mantissa part (maximum 6 digits) and [Power value display] indicated by the index part displayed by $\times 10^6$ or $\times 10^3$.

If the DOWN button is pressed for 1 second, the mantissa part will be displayed in 9 digits and the power value will be displayed as $\times 10^3$.

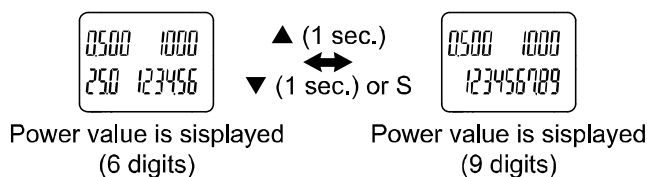

*: If there is no button operation for 30 seconds while the 9-digit power is displayed, the number of displayed powers will return to 6 digits.

*: When the temperature is set to "hide", the displayed power value is fixed at 9 digits.

- Zero-clear function

When the pressure is displayed in the measurement display setting, the displayed value can be adjusted to zero within the range of $\pm 7\%$ F.S. from the factory default value.

(The zero clear range varies by $\pm 1\%$ F.S. due to variation between individual products.)

When the UP and DOWN buttons are pressed for 1 second or longer simultaneously in measurement mode, the image below is displayed and the displayed value is reset to zero.

The display returns to measurement mode automatically.

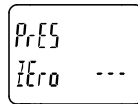

Zero-clear

- Key-lock function

The key lock function is used to prevent errors occurring due to unintentional changes of the set values. If SET button is pressed while the keys are locked, [LoC] is displayed on the sub display (left) for

approximately

1 second.

(Each setting and peak/ bottom values are displayed with UP and DOWN buttons.)

<Operation – Without security code input>

(1) Press the SET button for 5 seconds or longer in measurement mode. When [oPE] is displayed on the main display, release the button.

The current setting [LoC] or [UnLoC] will be displayed on the sub display.

(To release key-lock repeat the above operation)

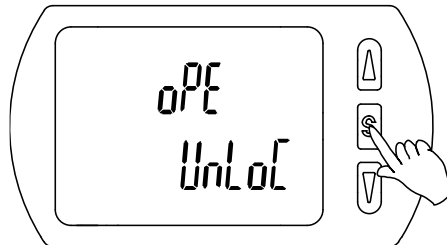

(2) Select the key locking/un-locking using the UP or DOWN button, and press the SET button to set.

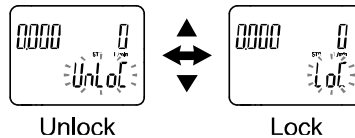

<Operation – Without security code input>

•Locking

- (1) Press the SET button for 5 seconds or longer in measurement mode. When [oPE] is displayed on the main display, release the button.

The current setting [LoC] or [UnLoC] will be displayed on the sub display.

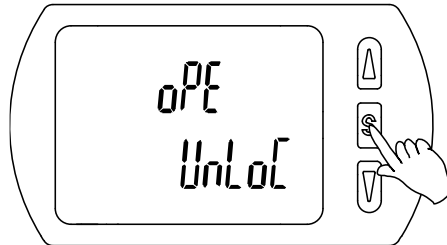

- (2) Select the key locking/ un-locking with UP or DOWN button, and press the SET button to set.

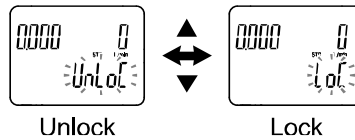

•Unlocking

- (1) Press the SET button for 5 seconds or longer in measurement mode. When [oPE] is displayed on the main display, release the button.

The current setting [LoC] or [UnLoC] will be displayed on the sub display.

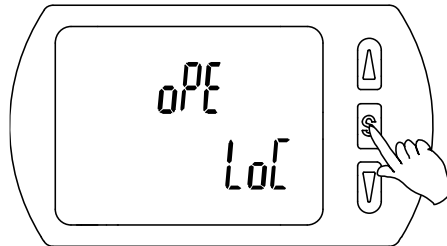

- (2) Select the un-locking [UnL] with UP or DOWN button. Setting is recognized by pressing the SET button, then security code is required. When the security code is set, select the un-lock [UnLoC] with UP or DOWN button. Setting is recognized by pressing the SET button, then the security code is required. If the security code is not set, select the un-lock [UnLoC]. Locking is released by pressing the SET button.

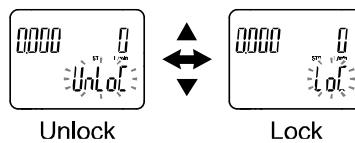

- (3) For the input method, refer to [F81] Security code (checking of the setting of security code) (page 56).

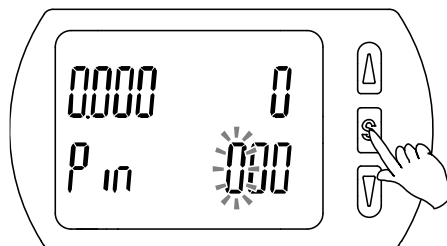

- (4) If inputted security code is correct, the indication of the main display changes to [UnLoC], and pressing one of UP, SET or DOWN button releases key lock and the measurement mode returns.
If the security code entered is incorrect, [FAL] will be displayed on the main screen, and the security code must be entered again. If an incorrect security code is entered 3 times, [LoC] will be displayed on the main screen and the device will return to measurement mode.

Maintenance

How to reset the product after a power loss or when the power has been unexpectedly removed

The settings for the product are retained in memory prior to the power loss or de-energizing of the product. The output condition is also recoverable to that prior to the power loss or de-energizing. However, this may change depending on the operating environment. Therefore, check the safety of the whole installation before operating the product.

If the installation is using accurate control, wait until the product has warmed up (approximately 10 to 15 minutes) before operation.

Forgotten the Security Code

If you have forgotten your security code, please contact SMC directly.

IO-Link Specifications

■ Outline of IO-Link functions

○ Communication function

This product can check the measured value, diagnostic information and switch output status using cyclic data communication via the IO-Link system.

○ Product status monitoring function

This function monitors the product status via the IO-Link.

- Several errors (e.g. internal hardware errors) can be monitored.
- Detects multiple warning conditions (flow rate error, Internal failure, etc.).

○ Data storage function

The Data storage function stores the IO-Link device parameter settings to the IO-Link master.

With the IO-Link data storage function, the IO-Link device can be replaced easily without re-setting the equipment construction or setting parameters

When the device parameter is set and downloaded to the device using the IO-Link setting tool, the parameter will be uploaded to the data storage in the master by the system command after download (backup instruction by the communication command).

When the device is replaced with the same type of IO-Link device due to failure, the parameter settings stored in the master are downloaded automatically, device can be operated with the parameter settings of the previous device.

Device parameter setting is applicable to 3 types of back-up levels of the master setting ("Inactive", "back-up/Restore", "Restore").

"Back-up" implies the activation of upload and "restore" implies download.

■ Communication specifications

IO-Link type	Device
IO-Link version	V1.1
Communication speed	COM2 (38.4 kbps)
Min. cycle time	5.8 ms
Process data length	Input Data: 12 byte, Output Data: 0 byte
On request data communication	Available
Data storage function	Available
Event function	Available

■ Process data

Process data is the data which is exchanged periodically between the master and device.

This product process data consists of switch output status, error diagnostics, fixed output and measured value.

(Refer to the table below.)

Bit offset	Item	Notes
0	Accumulated flow SW1	0: OFF 1: ON
1	Accumulated flow SW2	0: OFF 1: ON
2	Flow rate SW1	0: OFF 1: ON
3	Flow rate SW2	0: OFF 1: ON
4	Temperature SW1	0: OFF 1: ON
5	Temperature SW2	0: OFF 1: ON
6	Pressure SW1	0: OFF 1: ON
7	Pressure SW2	0: OFF 1: ON
8	Flow rate unit	0: L 1: ft3
9	Flow rate criteria	0: STD 1: nor
10	Flow diagnosis	0: Normal 1: HHH
11	Temperature diagnosis	0: Normal 1: HHH/LLL
12	Pressure diagnosis	0: Normal 1: HHH/LLL
13	Fixed output	0: Normal output 1: Fixed output
14	Error	0: Normal 1: Abnormal
15	System error	0: Normal 1: Abnormal
16 to 31	Pressure measured value	With sign: 16 bit
32 to 47	Temperature measured value	With sign: 16 bit
48 to 63	Flow measured value	With sign: 16 bit
64 to 79	Accumulated flow rate lower limit	Without sign: 32 bit
80 to 95	Accumulated flow rate upper limit	Without sign: 32 bit

Bit offset	95	94	93	92	91	90	89	88	87	86	85	84	83	82	81	80
Item	Accumulated flow rate upper limit (PD)															

Bit offset	79	78	77	76	75	74	73	72	71	70	69	68	67	66	65	64
Item	Accumulated flow rate lower limit (PD)															

Bit offset	63	62	61	60	59	58	57	56	55	54	53	52	51	50	49	48
Item	Flow measured value (PD)															

Bit offset	47	46	45	44	43	42	41	40	39	38	37	36	35	34	33	32
Item	Temperature measured value (PD)															

Bit offset	31	30	29	28	27	26	25	24	23	22	21	20	19	18	17	16
Item	Pressure measured value (PD)															

Bit offset	15	14	13	12	11	10	9	8	7	6	5	4	3	2	1	0
Item	System error	Error	Fixed output	Pressure diagnosis	Temp. diagnosis	Flow diagnosis	Flow rate Criteria	Flow rate Unit	Pressure SW2	Pressure SW1	Temp. SW2	Temp. SW1	Flow rate SW2	Flow rate SW1	Accumulated flow SW2	Accumulated flow SW1

- The process data of this product is Big-Endian type.

When the transmission method of the upper communication is Little-Endian, the byte order will be changed.

Refer to the table below for the Endian type of the major upper communication.

Endian type	Upper communication protocol
Big-Endian type	Such as PROFIBUS and PROFINET
Little-Endian type	Such as EtherNET/IP, EtherCAT and CC-Link IE Field.

○Measurement/setting range

Measured object	Range	Rated range		Display/settable range	
		Min.	to Max.	Min.	to Max.
Flow rate	1,000 L/min	10	to 1000	10	to 1050
	2,000 L/min	20	to 2000	20	to 2100
Temperature	50 °C	0	to 50.0	-10.0	to 60.0
Pressure	1 MPa	0	to 1.000	-0.050	to 1.050
Accumulated flow	9,999,999,990 L	0	to 9,999,999,990	0	to 9,999,999,990

Measured object	Range	PD value			
		Rated range		Display/settable range	
		A	to B	C	to D
Flow rate	1,000 L/min	40	to 4000	40	to 4200
	2,000 L/min	40	to 4000	40	to 4200
Temperature	50 °C	0	to 500	-100	to 600
Pressure	1 MPa	0	to 1000	-50	to 1050
Accumulated flow	9,999,999,990 L	0	to 999999999	0	to 999999999

*: The flow ranges and relationship between the fluid and PD are shown in the figures below.

●Relationship between measured value and PD

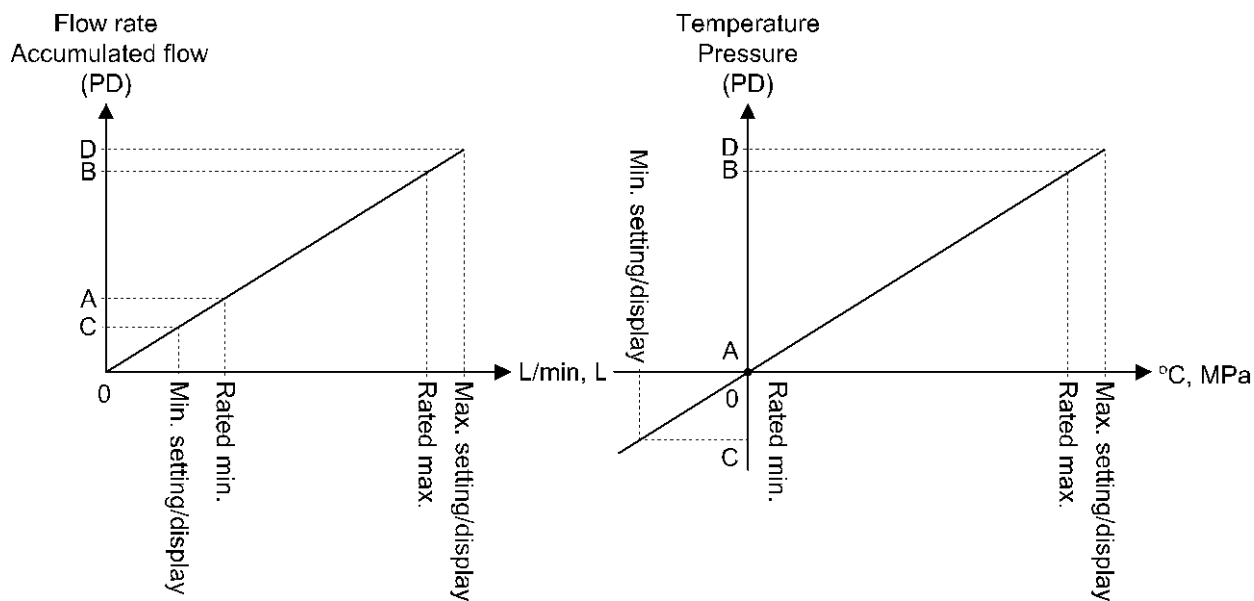

○ Conversion formula of the process data and flow/temperature measured value

(1) Conversion formula from the process data to the flow measured value:

$$Pr = a \times (PD) + b$$

(2) Conversion formula from the flow gauge measured value to the process data:

$$(PD) = (Pr - b) / a$$

Pr: Flow measured value and pressure set value

PD: Flow measured value (process data)

a: Inclination

b: Intercept

[Inclination and intercept to the unit specification]

Measured object	Range	Unit	Inclination a	Intercept b
Flow rate	1,000 L/min	L/min	0.25	0
		cfm	0.0088275	0
	2,000 L/min	L/min	0.5	0
		cfm	0.0176575	0
Temperature	50 °C	°C	0.1	0
		°F	0.18	32
Pressure	1 MPa	MPa	0.001	0
		kPa	1	0
		Kgf/cm ²	0.010197	0
		Bar	0.01	0
		Psi	0.14504	0
Accumulated flow	9,999,999,990 L	L	10	0
		Ft ³	1	0

[Calculation example]

(1) Conversion from the process data to the flow measured value

(For PF3A801H series, unit L/min, flow range 1000 L and PD = 2800)

$$\begin{aligned} Pr &= a \times (PD) + b \\ &= 0.25 \times 2800 + 0 \\ &= 700 \text{ [L/min]} \end{aligned}$$

(2) Conversion from the flow measured value to the process data

(For PF3A802H series, unit L/min, flow range 2000 L and Pr = 1750 [L/min])

$$\begin{aligned} (PD) &= (Pr - b) / a \\ &= [1750 - 0] / 0.50 \\ &= 3500 \end{aligned}$$

■ IO-Link parameter setting

○ IODD file

IODD (I/O Device Description) is a definition file which provides all properties and parameters required for establishing functions and communication of the device.

IODD includes the main IODD file and a set of image files such as vendor logo, device picture and device icon.

The IODD file is shown below.

Product No.	IODD file *
PF3A8*H-L2*-***	SMC-PF3A8*H-L2*-***-yyyymmdd-IODD1.1

: "" indicates the product No., and the product No. applicable to each IODD file input.

*: "yyyymmdd" indicates the file preparation date. yyyy is the year, mm is the month and dd is the date.

The IODD file can be downloaded from the SMC Web site (<https://www.smcworld.com>).

○ Service data

The tables below indicates the parameters which can be read or written by simple access parameter (direct parameters page) and ISDU parameters which are applicable to various parameters and commands.

● Direct parameters page 1

DPP1 address	Access	Parameter name	Initial value (dec)	Content
0x07	R	Vendor ID	0x0083 (131)	"SMC Corporation"
0x08				
0x09	R	Device ID	0X0232 (562) 0X0233 (563)	PF3A801H-L2x-xxx PF3A802H-L2x-xxx
0x0A				
0x0B				

•ISDU parameters

Index (dec)	Sub index	Access *1	Parameters	Initial value	Remarks
0x0002 (2)	0	W	System command	-	Refer to "System command" on page 81.
0x000C (12)	0	R/W	Device access lock	0x0000	Refer to "Device access lock parameter" on page 81.
0x0010 (16)	0	R	Vendor name	SMC Corporation	
0x0011 (17)	0	R	Vendor text	www.smcworld.com	
0x0012 (18)	0	R	Product name	Example: PF3A802H-L2x-xxx	
0x0013 (19)	0	R	Product ID	Example: PF3A802H-L2x-xxx	
0x0014 (20)	0	R	Product text	Flow sensor	
0x0015 (21)	0	R	Serial number	Example: "12345678"	•Initial value is indicated as 8-digit. •16 octets fixed character string
0x0016 (22)	0	R	Hardware version	HW-Vx.y	x: Large revision number y: Small revision number
0x0017 (23)	0	R	Software version	FW-Vx.y	x: Large revision number y: Small revision number
0x0024 (36)	0	R	Device status parameter	-	Refer to "Device state parameters" on page 81.
0x0025 (37)	0	R	Device detailed state parameter	-	Refer to "Device detailed state parameter" on page 82.
0x0028 (40)	0	R	Process data input	-	The latest value of process data can be read.

*1: R: Read, W: Write

- System command (index 2)

In the ISDU index 0x0002 SystemCommand (system command), the command shown in the table below will be issued.

The button of each system command is displayed on the IO-Link setting tool (excluding "ParamDownloadStore").

Click the button to send the system command to the product.

Writable commands are shown below.

Data type: 8 bit UInteger

Value	Function definition	Description
128	Device Reset	Restart <u>s</u> the device
129	Application Reset	Reset of the peak/bottom value (All flow rate/temperature/pressure) Reset of the accumulated value
130	Restore Factory Reset	Initialize the set value to the default value
160	Pressure Zero Clear	Pressure zero-clear
170	All Peak/Bottom Clear	Clear all peak/bottom value
171	FLOW Peak/Bottom Clear	Clear the flow rate peak/bottom value
172	TEMP Peak/Bottom Clear	Clear the temperature peak/bottom value
173	PRES Peak/Bottom Clear	Clear the pressure peak/bottom value
190	Accumu Reset	Reset of the accumulated value

- Device access lock parameter (index 12)

The contents are as follows.

Data type: 16 bit Record

Value	Contents
0	Key lock release, DS unlock (Initial value)
2	Key lock release, DS lock
8	Key lock, DS unlock
10	Key lock, DS lock

[Key lock]

This function prevents the user from physically changing the setting of the flow switch (button operation is not accepted).

Even when key lock function is activated, settings can be changed by IO-Link communication.

Restoration by data storage (overwriting parameter data) can be performed.

[Lock data storage (DS lock)]

Locking "Data storage" will invalidate the data storage function of the flow switch.

In this case, access will be denied for backup and restoration of data storage.

- Device state parameters (index 36)

Readable device states are as follows.

Data type: 8 bit UInteger

Value	State definition	Description
0	Normal operation	-
1	Maintenance inspection required	Not available
2	Outside specification range	Outside the measured range
3	Function check	Not available
4	Failure	Internal failure of digital flow switch

- Device detail status parameters (index 37)

Detailed event contents of readable device status are as follows.

Array	Event content	Event classification		Event code
		Definition	Value	
1	Internal failure of digital flow switch	Error	0xF4	0x8D02
2	Internal failure of digital flow switch	Error	0xF4	0x8D03
3	Internal failure of digital flow switch	Error	0xF4	0x8D04
4	Internal failure of digital flow switch	Error	0xF4	0x8D05
5	Internal failure of digital flow switch	Error	0xF4	0x8D01
6	Internal failure of digital flow switch	Error	0xF4	0x8D06
7	Internal failure of digital flow switch	Error	0xF4	0x8D08
8	Internal failure of digital flow switch	Error	0xF4	0x8CD0
9	Internal failure of digital flow switch	Error	0xF4	0x8CD1
10	OUT2 over current error	Error	0xF4	0x8CC0
11	Outside the accumulated flow value measurement	warning	0xE4	0x8D80
12	Outside the flow rate range	warning	0xE4	0x8D60
13	Outside the temperature range	warning	0xE4	0x8D61
14	Outside the pressure range	warning	0xE4	0x8D62
15	Below the temperature range	warning	0xE4	0x8D71
16	Below the pressure range	warning	0xE4	0x8D72
17	Test event A	warning	0xE4	0x8CA0
18	Test event B	warning	0xE4	0x8CA1
19	Data storage upload request	notification	0x54	0xFF91

●Product individual parameters

Index		Sub index	Access *1	Parameter	Data type *2	Initial value	Data storage *3	Set value *4	Remarks
dec	hex								
1000	0x03E8	0	R/W	Flow Unit (Selection of display unit)	U8	0	Y	0: L/min (L) 1: cfm (ft ³)	When the unit selection function is not included, a read/write to an un-selectable item is rejected.
1010	0x03F2	0	R/W	CoL (Selection of display colour)	U8	2	Y	0: rEd (Constantly red) 1: Grn (Constantly green) 2: 1SoG (OUT1 turns green at ON) 3: 1Sor (OUT1 turns red at ON) 4: 2SoG (OUT2 turns green at ON) 5: 2Sor (OUT2 turns red at ON)	Setting of display colour
1020	0x03FC	0	R/W	N or P (Switch NPN/PNP)	U8	1	Y	0: nPn 1: PnP	Setting the switch output
1070	0x042E	0	R/W	Reference condition	U8	0	Y	0: std (Standard condition) 1: nor (Normal condition)	
1080	0x0438	0	R/W	Temperature Unit (Selection of temperature display unit)	U8	0	Y	0: C 1: F	When the unit selection function is not included, a read/write to an un-selectable item is rejected.
1090	0x0442	0	R/W	Pressure Unit (Selection of pressure display unit)	U8	0	Y	0: MPa 1: kPa 2: kgf/cm ² 3: bar 4: psi	When the unit selection function is not included, a read/write to an un-selectable item is rejected.
1200	0x04B0	0	R/W	OUT1 setting OUT1 (Select the target for setting)	U8	0	Y	0: FLOW (Flow rate) 1: Temp (Temperature) 2: PrES (Pressure) 3: AC (Accumulated) 4: PLS (Accumulated pulse) 5: Err (Error output) 6: oFF (Output OFF)	
1210	0x04BA	1	R/W	ModE1 (Selection of output mode)	U8	0	Y	0: HYS (Hysteresis) 1: Wind (Window comparator)	
		2	R/W	1ot (Selection of output type)	U8	0	Y	0: 1_P (Normal output) 1: 1_n (Reverse output)	Setting of OUT1 output normal and reserved output
1220	0x04C4	1	R/W	P_1 (n_1) (Selection of output set value)	S16	2000	Y	Setting range 0x0028 to 0x1068 (40 to 4200)	Setting of OUT1 output set value (Hysteresis)
		2	R/W	H_1 (Setting of OUT1 hysteresis)	U16	200	Y	Setting range 0x0000 to 0x1040 (0 to 4160)	Setting of OUT1 hysteresis (Hysteresis)
		3	R/W	P1L (n1L) (Lower limit of window comparator)	S16	1200	Y	Setting range 0x0028 to 0x1068 (40 to 4200)	Setting of OUT1 output set value (Lower limit of window comparator)
		4	R/W	P1H (n1H) (Upper limit of window comparator)	S16	2400	Y	Setting range 0x0028 to 0x1068 (40 to 4200)	Setting of OUT1 output set value (Upper limit of window comparator)
		5	R/W	WH1 (Window comparator hysteresis)	U16	400	Y	Setting range 0x0000 to 0x0820 (0 to 2080)	Setting of OUT1 hysteresis (Window comparator)
		6	R/W	dtH1 (Delay time ON)	U16	0	Y	Setting range 0x0000 to 0x1770 (0 to 6000)	Setting of OUT1 delay time ON 10 ms increments
		7	R/W	dtL1 (Delay time OFF)	U16	0	Y		Setting of OUT1 delay time OFF 10 ms increments

●Product individual parameters (continued)

Index		Sub index	Access *1	Parameter	Data type *2	Initial value	Data storage *3	Set value *4	Remarks
dec	hex								
1230	0x04CE	1	R/W	ModE1 (Selection of output mode)	U8	0	Y	0: HYS (Hysteresis) 1: Wind (Window comparator)	
		2	R/W	1ot (Selection of output type)	U8	0	Y	0: 1_P (Normal output) 1: 1_n (Reverse output)	Setting of OUT1 output normal and reserved output
1240	0x04D8	1	R/W	P_1 (n_1) (Selection of output set value)	S16	250	Y	Setting range 0xFF9C to 0x0258 (-100 to 600)	Setting of OUT1 output set value (Hysteresis)
		2	R/W	H_1 (Setting of OUT1 hysteresis)	U16	25	Y	Setting range 0x0000 to 0x02BC (0 to 700)	Setting of OUT1 hysteresis (Hysteresis)
		3	R/W	P1L (n1L) (Lower limit of window comparator)	S16	150	Y	Setting range 0xFF9C to 0x0258 (-100 to 600)	Setting of OUT1 output set value (Lower limit of window comparator)
		4	R/W	P1H (n1H) (Upper limit of window comparator)	S16	300	Y	Setting range 0xFF9C to 0x0258 (-100 to 600)	Setting of OUT1 output set value (Upper limit of window comparator)
		5	R/W	WH1 (Window comparator hysteresis)	U16	50	Y	Setting range 0x0000 to 0x015E (0 to 350)	Setting of OUT1 hysteresis (Window comparator)
		6	R/W	dtH1 (Delay time ON)	U16	0	Y	Setting range 0x0000 to 0x1770 (0 to 6000)	Setting of OUT1 delay time ON 10 ms increments
		7	R/W	dtL1 (Delay time OFF)	U16	0	Y	Setting range 0x0000 to 0x1770 (0 to 6000)	Setting of OUT1 delay time OFF 10 ms increments
1250	0x04E2	1	R/W	ModE1 (Selection of output mode)	U8	0	Y	0: HYS (Hysteresis) 1: Wind (Window comparator)	
		2	R/W	1ot (Selection of output type)	U8	0	Y	0: 1_P (Normal output) 1: 1_n (Reverse output)	Setting of OUT1 output normal and reserved output
1260	0x04EC	1	R/W	P_1 (n_1) (Selection of output set value)	S16	500	Y	Setting range 0xFFCE to 0x041A (-50 to 1050)	Setting of OUT1 output set value (Hysteresis)
		2	R/W	H_1 (Setting of OUT1 hysteresis)	U16	50	Y	Setting range 0x0000 to 0x044C (0 to 1100)	Setting of OUT1 hysteresis (Hysteresis)
		3	R/W	P1L (n1L) (Lower limit of window comparator)	S16	300	Y	Setting range 0xFFCE to 0x041A (-50 to 1050)	Setting of OUT1 output set value (Lower limit of window comparator)
		4	R/W	P1H (n1H) (Upper limit of window comparator)	S16	600	Y	Setting range 0xFFCE to 0x041A (-50 to 1050)	Setting of OUT1 output set value (Upper limit of window comparator)
		5	R/W	WH1 (Window comparator hysteresis)	U16	100	Y	Setting range 0x0000 to 0x0226 (0 to 550)	Setting of OUT1 hysteresis (Window comparator)
		6	R/W	dtH1 (Delay time ON)	U16	0	Y	Setting range 0x0000 to 0x1770 (0 to 6000)	Setting of OUT1 delay time ON 10 ms increments
		7	R/W	dtL1 (Delay time OFF)	U16	0	Y	Setting range 0x0000 to 0x1770 (0 to 6000)	Setting of OUT1 delay time OFF 10 ms increments

●Product individual parameters (continued)

Index		Sub index	Access *1	Parameter	Data type *2	Initial value	Data storage *3	Set value *4	Remarks	
dec	hex									
1290	0x050A	0	R/W	OUT1 setting (AC)	AC_1ot (Selection of output type)	U8	0	Y	0: 1_P (Normal output) 1: 1_n (Reverse output)	
1300	0x0514	0	R/W		P1(n1)_L (Selection of output set value)	U32	0	Y	0 to 999,999,999	Common for all ranges, units, and criterion
1310	0x051E	0	R/W		P1(n1)_ft3 (Selection of output set value)	U32	0	Y	0 to 999,999,999	Common for all ranges, units, and criterion
1320	0x0528	0	R/W	OUT1 setting (PLS)	PLS1_L	U8	0	Y	0: 10 (L/pulse) 1: 100 (L/pulse)	OUT1 accumulated pulse converted value setting
1330	0x0532	0	R/W		PLS1_Ft ³	U8	0	Y	1000 L range 0: 0.1 (L/pulse) 1: 1(L/pulse) 2000 L range 0: 1 (Ft ³ /pulse) 1: 10 (Ft ³ /pulse)	
1340	0x053C	0	R/W	OUT1 setting (PLS/Err)	1ot (Selection of output type)	U8	0	Y	0: 1_P (Normal output) 1: 1_n (Reverse output)	Setting of OUT1 output normal and reserved output.
1400	0x0578	0	R/W	OUT2 setting	OUT2 (Select the target for setting)	U8	0	Y	0: FLOW (Flow rate) 1: Temp (Temperature) 2: PrES (Pressure) 3: AC (Accumulated) 4: PLS (Accumulated pulse) 5: Err (Error output) 6: oFF (Output OFF)	
1410	0x0582	1	R/W	OUT2 setting (Flow)	ModE2 (Selection of output mode)	U8	0	Y	0: HYS (Hysteresis) 1: Wind (Window comparator)	
		2	R/W		2ot (Selection of output type)	U8	0	Y	0: 1_P (Normal output) 1: 1_n (Reverse output)	Setting of OUT2 output normal and reserved output
1420	0x058C	1	R/W	OUT2 setting (Flow)	P_2 (n_2) (Selection of output set value)	S16	2000	Y	Setting range 0x0028 to 0x1068 (40 to 4200)	Setting of OUT2 output set value (Hysteresis)
		2	R/W		H_2 (Setting of OUT1 hysteresis)	U16	200	Y	Setting range 0x0000 to 0x1040 (0 to 4160)	Setting of OUT2 hysteresis (Hysteresis)
		3	R/W		P2L (n2L) (Lower limit of window comparator)	S16	1200	Y	Setting range 0x0028 to 0x1068 (40 to 4200)	Setting of OUT2 output set value (Lower limit of window comparator)
		4	R/W		P2H (n2H) (Upper limit of window comparator)	S16	2400	Y	Setting range 0x0028 to 0x1068 (40 to 4200)	Setting of OUT2 output set value (Upper limit of window comparator)
		5	R/W		WH2 (Window comparator hysteresis)	U16	400	Y	Setting range 0x0000 to 0x0820 (0 to 2080)	Setting of OUT2 hysteresis (Window comparator)
		6	R/W		dtH2 (Delay time ON)	U16	0	Y	Setting range 0x0000 to 0x1770 (0 to 6000)	Setting of OUT2 delay time ON 10 ms increments
		7	R/W		dtL2 (Delay time OFF)	U16	0	Y		Setting of OUT2 delay time OFF 10 ms increments

●Product individual parameters (continued)

Index		Sub index	Access *1	Parameter	Data type *2	Initial value	Data storage *3	Set value *4	Remarks
dec	hex								
1430	0x0596	1	R/W	ModE2 (Selection of output mode)	U8	0	Y	0: HYS (Hysteresis) 1: Wind (Window comparator)	
		2	R/W	2ot (Selection of output type)	U8	0	Y	0: 1_P (Normal output) 1: 1_n (Reverse output)	Setting of OUT2 output normal and reserved output
1440	0x05A0	1	R/W	P_2 (n_2) (Selection of output set value)	S16	250	Y	Setting range 0xFF9C to 0x0258 (-100 to 600)	Setting of OUT2 output set value (Hysteresis)
		2	R/W	H_2 (Setting of OUT1 hysteresis)	U16	25	Y	Setting range 0x0000 to 0x02BC (0 to 700)	Setting of OUT2 hysteresis (Hysteresis)
		3	R/W	P2L (n2L) (Lower limit of window comparator)	S16	150	Y	Setting range 0xFF9C to 0x0258 (-100 to 600)	Setting of OUT2 output set value (Lower limit of window comparator)
		4	R/W	P2H (n2H) (Upper limit of window comparator)	S16	300	Y	Setting range 0xFF9C to 0x0258 (-100 to 600)	Setting of OUT2 output set value (Upper limit of window comparator)
		5	R/W	WH2 (Window comparator hysteresis)	U16	50	Y	Setting range 0x0000 to 0x015E (0 to 350)	Setting of OUT2 hysteresis (Window comparator)
		6	R/W	dtH2 (Delay time ON)	U16	0	Y	Setting range 0x0000 to 0x1770 (0 to 6000)	Setting of OUT2 delay time ON 10 ms increments
		7	R/W	dtL2 (Delay time OFF)	U16	0	Y	Setting range 0x0000 to 0x1770 (0 to 6000)	Setting of OUT2 delay time OFF 10 ms increments
1450	0x05AA	1	R/W	ModE2 (Selection of output mode)	U8	0	Y	0: HYS (Hysteresis) 1: Wind (Window comparator)	
		2	R/W	2ot (Selection of output type)	U8	0	Y	0: 1_P (Normal output) 1: 1_n (Reverse output)	Setting of OUT2 output normal and reserved output
1460	0x05B4	1	R/W	P_2 (n_2) (Selection of output set value)	S16	500	Y	Setting range 0xFFCE to 0x041A (-50 to 1050)	Setting of OUT2 output set value (Hysteresis)
		2	R/W	H_2 (Setting of OUT1 hysteresis)	U16	50	Y	Setting range 0x0000 to 0x044C (0 to 1100)	Setting of OUT2 hysteresis (Hysteresis)
		3	R/W	P2L (n2L) (Lower limit of window comparator)	S16	300	Y	Setting range 0xFFCE to 0x041A (-50 to 1050)	Setting of OUT2 output set value (Lower limit of window comparator)
		4	R/W	P2H (n2H) (Upper limit of window comparator)	S16	600	Y	Setting range 0xFFCE to 0x041A (-50 to 1050)	Setting of OUT2 output set value (Upper limit of window comparator)
		5	R/W	WH2 (Window comparator hysteresis)	U16	100	Y	Setting range 0x0000 to 0x0226 (0 to 550)	Setting of OUT2 hysteresis (Window comparator)
		6	R/W	dtH2 (Delay time ON)	U16	0	Y	Setting range 0x0000 to 0x1770 (0 to 6000)	Setting of OUT2 delay time ON 10 ms increments
		7	R/W	dtL2 (Delay time OFF)	U16	0	Y	Setting range 0x0000 to 0x1770 (0 to 6000)	Setting of OUT2 delay time OFF 10 ms increments

●Product individual parameters (continued)

Index		Sub index	Access *1	Parameter		Data type *2	Initial value	Data storage *3	Set value *4	Remarks
dec	hex									
1490	0x05D2	0	R/W	OUT2 setting (AC)	AC_2ot (Selection of output type)	U8	0	Y	0: 1_P (Normal output) 1: 1_n (Reverse output)	
1500	0x05DC	0	R/W		P2(n2)_L (Selection of output set value)	U32	0	Y	0 to 999,999,999	Common for all ranges, units, and criterion
1510	0x05E6	0	R/W		P2(n2)_ft3 (Selection of output set value)	U32	0	Y	0 to 99,999,999	Common for all ranges, units, and criterion
1520	0x05F0	0	R/W	OUT2 setting (PLS)	PLS2_L	U8	0	Y	0: 10 (L/pulse) 1: 100 (L/pulse)	OUT2 accumulated pulse converted value setting
1530	0x05FA	0	R/W		PLS2_Ft ³	U8	0	Y	1000 L range 0: 0.1 (L/pulse) 1: 1 (L/pulse) 2000 L range 0: 1 (Ft ³ /pulse) 1: 10 (Ft ³ /pulse)	
1540	0x0604	0	R/W	OUT2 setting (PLS/Er)	2ot (Selection of output type)	U8	0	Y	0: 2_P (Normal output) 1: 2_n (Reverse output)	Setting of OUT2 normal and reversed output
1600	0x0640	0	R/W	Dir (Setting of the accumulated flow direction)		U8	0	Y	0: Add 1: dEC1 2: dEC2	Addition/Subtraction
1800	0x0708	1	R/W	FIL_FLoW (Digital filter_flow rate)		U8	0	Y	0: 1.0 sec 1: 2.0 sec 2: 5.0 sec	Set digital filter
		2	R/W	FIL_PrES (Digital filter_pressure)		U16	10	Y	0 to 3000 ms	10 ms increments (0 to 30 sec.)
1810	0x0712	0	R/W	FSC_PrES (Fine adjustment of the pressure span)		S16	0	N	-50 to 50	0.1% increments (-5 to 5%)
2000	0x07D0	0	R/W	Sub (Sub screen display)		U8	0	Y	Refer to the Fig. Data for the sub screen display (Page 90)	
2020	0x07E4	0	R/W	rEv (Reserved display)		U8	0	Y	0: Normal display 1: Reversed display	
2030	0x07EE	1	R/W	Zero Cut(Flow)		U8	1	Y	0 to 10	Zero cut-off setting 1.0% increments
		2	R/W	Zero Cut (PrES)		U8	0	Y		
2050	0x0802	1	R/W	Mes disp/hide_PrES (Measurement display/ hide_pressure)		U8	0	Y	0: diSP (displayed) 1: HidE (hidden)	Measurement display/hide setting
		2	R/W	Mes disp/hide_tEMP (Measurement display/ hide_temperature)		U8	0	Y	0: diSP (displayed) 1: HidE (hidden)	
		3	R/W	Mes disp/hide_AC (Measurement display/ hide_accumulated flow rate)		U8	0	Y	0: diSP (displayed) 1: HidE (hidden)	
2200	0x0898	0	R/W	SAvE (Accumulated flow value hold setting)		U8	0	Y	0: oFF (Not held) 1: 2.0 min 2: 5.0 min	
2400	0x0960	0	R/W	Display OFF (Display OFF setting)		U8	0	Y	0: on 1: oFF	
2410	0x096A	1	R/W	Security code	Pin (Security code Used/Not used)	U8	0	Y	0: unused 1: use	
		2	R/W		PinCode (Security code setting)	U16	0	Y	Setting range 0x0000 to 0x03E7 (0 to 999)	

●Product individual parameters (continued)

Index		Sub index	Access *1	Parameter	Data type *2	Initial value	Data storage *3	Set value *4	Remarks	
dec	hex									
7000	0x1B58	0	W	Communication OUT test	U8	0	N	0: Normal output 1: Fixed output	The PD becomes 1 when a fixed output has been received	
7010	0x1B62	0	W		Toggle output command	U8	-	N	Refer to table "Toggle output command". (Page 89)	
8000	0x1F40	0	R	Measurement related	Flow rate PD conversion equation: a	F32	-	N	Refer to "Inclination and intercept to the unit specification". (Page 78)	
8010	0x1F4A	0	R		Flow rate PD conversion equation: b	F32	-	N		
8020	0x1F54	0	R		Flow peak value	S16	-	N	0x0000 to 0x1068 (0 to 4200)	
8030	0x1F5E	0	R		Flow bottom value	S16	-	N		
8060	0x1F7C	0	R		Accumulated PD conversion equation: a	F32	-	N	Refer to "Inclination and intercept to the unit specification". (Page 78)	
8070	0x1F86	0	R		Accumulated PD conversion equation: b	F32	-	N		
8200	0x2008	0	R		Temperature PD conversion equation: a	F32	-	N		
8210	0x2012	0	R		Temperature PD conversion equation: b	F32	-	N		
8220	0x201C	0	R		Flow peak value	S16	-	N		0xFF9C to 0x0258 (-100 to 600)
8230	0x2026	0	R		Flow bottom value	S16	-	N		
8400	0x20D0	0	R		Pressure PD conversion equation: a	F32	-	N	Refer to "Inclination and intercept to the unit specification". (Page 78)	
8410	0x20DA	0	R		Pressure PD conversion equation: b	F32	-	N		
8420	0x20E4	0	R		Flow peak value	S16	-	N	0xFFCE to 0x041A (-50 to 1050)	
8430	0x20EE	0	R		Flow bottom value	S16	-	N		

*1: "R" means Read and "W" means Write.

*2: Refer to the table below for the symbol.

Symbol	Data type (IO-Link standard)	Data length Bit [byte]	Description
U8	UIntegerT	8[1]	Unsigned integer
U16		16[2]	
S16	IntegerT	16[2]	Signed integer
F32	Float32T	32[4]	Floating point number

*3: "Y" indicates that the parameter setting data is saved to the master, and "N" indicates that the parameter is not saved.

*4: Read/write to un-selectable items will be rejected depending on the product No.

[Toggle output command]

Item		Value	Notes
Measured value	Accumulated	0	Connected with hardware output (Since OUT1 is IO-Link communication, only the indicator light is linked.)
	Flow rate	1	
	Temperature	2	
	Pressure	3	
OUT output bit	OUT1	16	Reverse only the bits of the process data. Even if the bit is the object of OUT output, it does not affect the OUT output and indicator light.
	OUT2	17	
SW output bit	Accumulated 1	32	Connected with hardware output (Not connected as OUT2 does not have the hardware)
	Accumulated 2	33	
	Flow rate 1	34	
	Flow rate 2	35	
	Temperature 1	36	
	Temperature 2	37	
	Pressure 1	38	
Pressure 2	39		
Pulse output 2		65	This is valid only when the output object of OUT2 is pulse output.
Display unit bit		208	
Unit reference bit		209	
Flow diagnosis bit		224	
Temperature diagnosis bit		225	
Pressure diagnosis bit		226	
Error bit		254	
System error bit		255	

[Data for sub screen]

Value	Setting content		Supplemental information	
0	Measurement display		Initial value	
1	OUT1 set value display	Flow rate HYS mode set value	Values that do not match the OUT* output mode settings can also be written. In this case, there is a contradiction in the display of the sub screen.	
2		Flow rate HYS mode hysteresis		
3		Flow rate Wind mode lower side set value		
4		Flow rate Wind mode upper side set value		
5		Flow rate Window comparator mode hysteresis		
6		Temperature HYS mode set value		
7		Temperature HYS mode hysteresis		
8		Temperature Wind mode lower side set value		
9		Temperature Wind mode upper side set value		
10		Temperature Wind mode hysteresis		
11		Pressure HYS mode set value		
12		Pressure HYS mode hysteresis		
13		Pressure Wind mode lower side set value		
14		Pressure Wind mode upper side set value		
15		Pressure Wind mode hysteresis		
16		AC mode set value		
17		PLS mode set value		
18		Err mode		
19	oFF mode			
20	OUT2 set value display	Flow rate HYS mode set value		
21		Flow rate HYS mode hysteresis		
22		Flow rate Wind mode lower side set value		
23		Flow rate Wind mode upper side set value		
24		Flow rate Wind mode hysteresis		
25		Temperature HYS mode set value		
26		Temperature HYS mode hysteresis		
27		Temperature Wind mode lower side set value		
28		Temperature Wind mode upper side set value		
29		Temperature Wind mode hysteresis		
30		Pressure HYS mode set value		
31		Pressure HYS mode hysteresis		
32		Pressure Wind mode lower side set value		
33		Pressure Wind mode upper side set value		
34		Pressure Wind mode hysteresis		
35		AC mode set value		
36		PLS mode set value		
37		Err mode		
38		oFF mode		
39	Flow bottom value			
40	Flow peak value			
41	Temperature bottom value			
42	Temperature peak value			
43	Pressure bottom value			
44	Pressure peak value			
45	IO-Link mode display			Upper line: SIO mode/SDCI mode Lower line: Device ID

Troubleshooting

If an operation failure of the product occurs, please confirm the cause of the troubles from the following table. If a cause applicable to the troubles cannot be identified and normal operation can be recovered by replacement with a new product, this indicates that the product itself was faulty. Problems with the product may be due to the operating environment (installation etc). Please consult SMC.

●Cross-reference for troubleshooting

Error indication	Problem Possible causes	Investigation method	Countermeasure
<ul style="list-style-type: none"> •The Auto switch output does not turn off. The indicator light stays ON •The switch output does not turn on Operation LED stays OFF 	Incorrect setting	(1) Setting check. (2) Check the settings of the operation mode, hysteresis and output type. (in hysteresis mode or window comparator mode, and normal output/ reversed output)	(1) Perform setting again. (2) Change the response time setting.
	Product failure		Replace the product
The output does not turn off. Indicator light is normal	Incorrect wiring	Check the output wiring. Check if the load is directly connected to DC(+) or DC(-).	Check and correct the wiring.
	Product failure		Replace the product
The output does not turn on. Indicator light is normal	Incorrect wiring	Check the output wiring. Check if the load is directly connected to DC(+) or DC(-).	Check and correct the wiring.
	Model Selection	Check if PNP output is used when NPN should have been selected, or the other way around.	Revise the output settings.
	Lead wire broken	Check if there is bending stress applied to any part of the lead wire. (bending radius, tensile force to the lead wire)	Correct the wiring. (Reduce the tensile force or increase the bending radius.)
	Product failure		Replace the product
The switch output generates chattering.	Incorrect wiring	Check the wiring. Check if the brown and blue wires are connected to DC(+) and DC(-) respectively, and if the output line is secure (contact failure).	Correct the connection on the power cord and the plug.
	Incorrect setting	(1) Setting check. (2) Check if the tolerance range is small.	(1) Perform setting again. (2) Make the tolerance wider.
	Product failure		Replace the product

Error indication	Problem Possible causes	Investigation method	Countermeasure
<ul style="list-style-type: none"> •Over current error (Er1, 2) is displayed •System error (Er0, 4 to 16, 40) is displayed •"HHH", "LLL" is displayed 	Excess current was applied to the output (Er1, 2)	<ul style="list-style-type: none"> (1) Check if the output current is 80 mA or greater. (2) Check if the connected load complies with the specification. Check if the load is short circuited. (3) Check if the relay without surge protection is connected. (4) Check if the wiring is in the same route as (or bundled together with) a high-voltage or power line. 	<ul style="list-style-type: none"> (1)(2) Connect the appropriate load. (3) Use a relay with a surge voltage suppressor or take measures to prevent surge. (4) Separate the wiring from the high-voltage and/or power line.
	Incorrect internal data processing of the product (Er0, 4 to 16, 40)	<ul style="list-style-type: none"> (1) Check if there is noise interference (such as static electricity). Check if there is a noise source nearby. (2) Check if the power supply voltage is in the range 21.6 to 30 V. 	<ul style="list-style-type: none"> (1) Remove the noise and the noise source (or take measures to prevent noise interference), and reset the product (or turn off and then turn back on the power supply). (2) Check that the Power supply voltage is 21.6 to 30 V.
	The measured value exceeds the upper limit (HHH) or lower limit (LLL)	<ul style="list-style-type: none"> (1) Check if the value exceeds the upper or lower limit of the set range. (2) Check if foreign matter has entered the piping. 	<ul style="list-style-type: none"> (1) Return the value to within the set range. (2) Take measures to prevent foreign matter from entering the piping.
	Product failure		Replace the product
The display is unstable.	Incorrect power supply	Check if the power supply voltage is in the range 21.6 to 30 V.	Power supply voltage is 21.6 to 30 V.
	Incorrect wiring	Check the power supply wiring Check if the brown and blue wires are connected to DC(+) and DC(-) respectively, and if the wiring is secure	Check and correct the wiring.
	Factory line pressure is not stable	Check if the factory line pressure is changing.	Setting of the response time may improve the condition.

Error indication	Problem Possible causes	Investigation method	Countermeasure
<ul style="list-style-type: none"> •The display turns off. •Part of the display is missing. 	Incorrect power supply	Check if the power supply voltage is 21.6 to 30 V.	Power supply voltage is 21.6 to 30 V.
	Incorrect wiring	Check the power supply wiring Check if the brown and blue wires are connected to DC(+) and DC(-) respectively, and if the wiring is secure	Check and correct the wiring.
	Display off mode	Check if display off mode is selected.	Select the power saving mode again.
	Product failure		Replace the product
Display flashes	Incorrect wiring	(1) Check the power supply wiring. (2) Check if there is bending stress applied to any part of the lead wire.	(1) Check and correct the wiring. (2) Correct the wiring (bend radius and stress).
The display accuracy does not meet the specifications.	Foreign matter entered	Confirmed foreign matter entry or sticking to the piping port.	Use a filter to prevent foreign matter from entering or sticking. Discharge the condensate of the filter periodically.
	Air leakage	Check if air is leaking from the piping.	Rework the piping. If the tightening torque is exceeded, the mounting screws, brackets and the flow switch may be damaged.
	Warming up inadequate	Check if the product satisfies the specified accuracy 10 minutes after supplying power.	After energizing, the display and output can drift. Allow the product to warm up for 10 to 15 minutes.
	Product failure		Replace the product
Display measurement unit cannot be changed.	Model Selection (model selected does not have unit conversion function)	Check if the product number printed on the product indicates Unit selection function type.	Unit selection function is not available for Fixed to SI units type. *: The unit conversion function is not for use in Japan due to a new measurement law. *: Unit fixed to SI:L/min
	Product failure		Replace the product
Buttons do not work	Key-lock mode is activated.	Check if the key-lock function is turned on.	Check the key-lock function.
	Product failure		Replace the product
There is noise.	Air leakage	Check if air is leaking from the piping.	Rework the piping. If the tightening torque is exceeded, the mounting screws and the switch may be damaged.
	Product failure		Replace the product

Error indication	Problem Possible causes	Investigation method	Countermeasure
The operation is unstable. (chattering)	The hysteresis is small and is affected by the fluctuations in the original pressure, etc.	Check the set value (hysteresis).	Check the settings
	Incorrect wiring/ broken lead wire	(1) Check the power supply wiring. (2) Check if there is bending stress applied to any part of the lead wire. (bending radius, tensile force to the lead wire)	(1) Check and correct the wiring. (2) Correct the wiring. (Reduce the tensile force or increase the bending radius.)
	Product failure		Replace the product





○Troubleshooting list (IO-Link communication)

Problem	Description	Problem possible causes	Investigation method	Countermeasures
	IO-Link indicator light ☑: OFF			
IO-Link indicator light ☑: Flashing	MODE ***	Communication is not established. IO-Link wiring failure	Check the connection and cable condition of the IO-Link cable.	Additionally tighten the IO-Link cable. (Replace the cable if it is broken.)
IO-Link indicator light ☑: Flashing	Er 15 V 10	IO-Link master and product version are not matched.	Check the IO-Link version of the master and device.	Align the master IO-Link version to the device. ^{□1}
	MODE Strt MODE Prt	Communication mode is not transferred to the Operation mode.	Check the setting of the data storage access lock and data storage backup level of the master.	Release the data storage access lock. Or deactivate the setting of the data storage backup level of the master port.
Data is swapped by byte.	-	Program data assignment is incorrect.	Check that the Endian type on the master upper level communication transmission format is Big Endian type or Little Endian type.	Assign the program data based on the Endian type of the transmission format of the master upper level communication. Or set to the master byte swap setting. (Refer to page 76 for the Endian type of the upper level communication)

*1: When the product is connected to the IO-Link master with version other than "V1.1", an error will be generated.

■ Error display

Error name	Error display	Description	Measures
Instantaneous flow error		Flow rate exceeding the upper limit of the settable flow range is applied.	Reset applied flow rate to a level within the settable flow range.
Pressure error		Pressure exceeding the upper limit of the set pressure range is applied.	Reset applied pressure to a level within the set pressure range.
		Pressure below the lower limit of the set pressure range is applied.	
Temperature error		Temperature exceeding the upper limit of the set temperature range is applied.	Reset applied temperature to a level within the settable temperature range.
		Temperature below the lower limit of the set temperature range is applied.	
Over current error		The switch output load current is 80 mA or more.	Turn the power off and remove the cause of the over current. Then supply the power again.
System error		An internal data error has occurred.	Turn the power off and on again. If the failure cannot be solved, contact SMC.

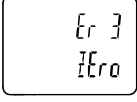
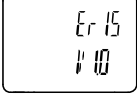
Error name	Error display	Description	Measures
Accumulated flow error		The accumulated value has exceeded the accumulated flow range. (For accumulated increment)	Reset the accumulated flow. (Press the DOWN and SET buttons simultaneously for 1 second or longer)
			
		The accumulated value has reached the set accumulated value. (For accumulated decrement)	
			
Zero clear error		A pressure of 7%F.S. or more is applied during the zero clear operation. (Return to measurement mode in one second)	Select the suitable IO-Link version for the device.
Version does not match		Version of master and IO-Link does not match.	Align the master IO-Link version to the device.

*: If the error cannot be reset after the above measures are taken, or errors other than above are displayed, please contact SMC.

Specifications

Models		PF3A801H	PF3A802H	
Fluid	Applicable fluid *1	Air, N ₂		
	Operating fluid temperature	0 to 50 °C		
Flow specifications	Detection method	Heating type sensor (branch flow type)		
	Rated flow range	10 to 1000 L/min	20 to 2000 L/min	
	Set flow rate range *2	Instantaneous flow	10 to 1050 L/min	20 to 2100 L/min
		Accumulated flow	0 to 9,999,999,990 L	
	Lowest configurable increment	Instantaneous flow	1 L/min	2 L/min
		Accumulated flow	10 L	
	Accumulated volume per pulse (Pulse width = 50 msec.)	Select from 10 L/pulse, 100 L/pulse		
	Accumulated value hold *3	2 or 5 minutes can be selected..		
Pressure specifications	Rated pressure range	0.000 to 1.000 MPa		
	Set pressure range *2	-0.050 to 1.050 MPa		
	Lowest configurable increment	0.001 MPa		
	Proof pressure	1.5 MPa		
	Pressure loss	Refer to the pressure loss graph		
Temp. specifications	Rated temperature range	0.0 to 50.0 °C		
	Set temperature range	-10.0 to 60.0 °C		
	Lowest configurable increment	0.1 °C		
Electrical specifications	Power supply voltage	21.6 to 30 VDC		
	Current consumption	150 mA or less		
	Protection	Polarity protection		
Accuracy	Accuracy	Flow rate *4	±3.0%F.S.	
		Pressure	±3.0%F.S.	
		Temp. *5	±2.5 °C.	
	Repeatability (Flow rate/Pressure)	±1.0%F.S.		
	Temperature characteristics (Flow rate/Pressure)	±5.0%F.S.(Ambient temp. 0 to 50 °C, 25 °C standard)		
	Pressure characteristics (Flow rate) *6	±5.0%F.S. (0 to 1.0 MPa, 0.5 MPa standard)		
	Impact when modular devices are connected (Flow rate) *7	±5.0%F.S.		

Models		PF3A801H	PF3A802H	
Switch output	Output type	Select from PNP open collector or NPN open collector (2 outputs)		
	Output mode	Hysteresis mode, window comparator mode, error output, output OFF, accumulated output and accumulated pulse output (Only flow rate)		
	Switch operation	Select from normal output or reversed output		
	Maximum load current	80 mA		
	Maximum applied voltage (Only NPN)	30 VDC		
	Internal voltage drop (Residual voltage)	1.5 V or less ((at load current 80 mA)		
	Response time	5 ms or less		
	Delay time * ⁸	Variable at 0 to 60 s/0.01 s step		
	Hysteresis * ⁹	Variable from 0		
	Protection	Over current protection		
Display	Reference condition * ¹⁰		Select from Standard condition or Normal condition	
	Unit * ¹¹	Instantaneous flow	L/min, CFM (ft ³ /min)	
		Accumulated flow	L, ft ³	
		Pressure	MPa, KPa, kgf/cm ² , bar, psi	
		Temp.	°C, °F	
	Display range	Instantaneous flow * ¹²	0 to 1050 L/min (Displays 0 when the value is below 10 L/min.)	0 to 2100 L/min (Displays 0 when the value is below 20 L/min.)
		Accumulated flow	0 to 9,999.99 x 10 ⁶ L (6 digit display) 0 to 9,999,999.99 x 10 ³ L (9 digit display)	
		Pressure * ¹²	-0.050 to 1.050 MPa	
		Temp.	-10.0 to 60.0 °C	
	Min. display unit	Instantaneous flow	1 L/min	2 L/min
		Accumulated flow	10 L	
		Pressure	0.001 MPa	
		Temp.	0.1 °C	
	Display	Display method: LCD Number of displays: 4 Display colour (upper line): Red and green Display colour (lower line): Orange Display (upper line/lower line): 10 digits (7 segment 5digits, 11 segment 5 digits)		
Operation LED	OUT LED: Orange is ON when output is ON			

Models		PF3A801H	PF3A802H
Digital filter *13	Flow rate	1 s (2 s or 5 s can be selected)	
	Pressure	0.1 s (Variable at 0 to 30 s/0.01 s step)	
	Temp.	1 s	
Environmental resistance	Protection	IP65	
	Withstand voltage	1000 V AC for 1 minute between terminals and housing	
	Insulation resistance	50 MΩ between terminals and housing (with 500 VDC megger)	
	Operating temperature range	Operation: 0 to 50 °C, Storage: -10 to 60 °C (No condensation or freezing)	
	Operating humidity range	Operation, Storage: 35 to 85%RH (No condensation)	
Standards		CE/UKCA marked	
Piping	Piping specification	Modular (Body size: 30)	Modular (Body size: 40)
Material of fluid contact parts		SUS304, Aluminum alloy, PPS, HNBR (Sensor: Pt, Au, Ni, Fe, lead glass (not RoHS compliant), Al2O3)	
Length of lead wire with connector		3 m	
Weight	Body	350 g	400 g
	Lead wire with connector	+90 g	

*1: The air quality class is according to JIS B 8392-1:2012 [6:6.4] and ISO8573-1:2010 [6:6.4].

Use an air filter with 5 μm or less filtration rating on the inlet side.

*2: The set range changes based on the setting of the zero cut-off function.

*3: When using the accumulated value hold function, calculate the product life from the operating conditions, and use the product within its life. The maximum update limit of the memory device is 1.5 million times.

If the product is energized for 24 hours per day, the product life will be as follows:

- Data memorized every 5 minutes --- 5 minutes x 1.5 million times = 7.5 million minutes = 14.3 years

- Data memorized every 2 minutes --- 2 minutes x 1.5 million times = 3 million minutes = 5.7 years

If the Accumulated Flow External Reset is repeatedly used, the product life will be shorter than calculated life.

*4: When pipe bore sizes 3/8 (PF3A701H) and 1/2 (PF3A702H) are connected.

*5: In the low flow rate range, the temperature value fluctuates (rises). Refer to the temperature accuracy chart. (Page 101)

*6: Do not release the OUT side piping port of the product directly to the atmosphere without connecting piping. If the product is used with the piping port released to atmosphere, accuracy may vary.

*7: These values are for modular products with a pipe bore size of 3/8 (PF3A701H), 1/2 (PF3A702H), and supply pressure of 0.5 MPa.

*8: The time can be set from when the instantaneous flow reaches the set value, to when the switch output actually begins working.

*9: If the applied voltage fluctuates around the set value, the width for setting more than the fluctuating width needs to be set. Otherwise, chattering will occur.

*10: The flow rate given in the specification is the value at standard condition (STD).

*11: This is only available for models with the units selection function.

*12: Displayable range change based on the setting of zero cut-off function.

*13: Set the time for digital filter to the sensor input. The response time indicates when the set value is 90% in relation to the step input.

*14: Any products with tiny scratches, smears, or display colour variation or brightness which does not affect the performance are verified as conforming products.

Communication specification (During IO-Link mode)

IO-Link type	Device
IO-Link version	V1.1
Communication speed	COM2 (38.4 kbps)
Configuration file	IODD file *1
Min. cycle time	5.8 ms
Process data length	Input Data: 12 byte, Output Data: 0 byte
On request data communication	Available
Data storage function	Available
Event function	Available
Vendor ID	131 (0x0083)
Device ID *2	PF3A801H-L2*-*: 562 (0x0232) PF3A802H-L2*-*: 563 (0x0233)

*1: The configuration file can be downloaded from the SMC website. (URL <https://www.smcworld.com>)

*2: The Device ID varies depending on the output specification of the product.

Cable specification for M12 connector and lead wire (ZS-37-A, ZS-49-A)

Item		Specifications
Conductor	Nominal cross section	AWG23
Insulator	O.D.	Approx. 1.1 mm
	Colours	Brown, blue, black, white
Sheath	Finish O.D.	ø4

■ Characteristics data

- Pressure loss (reference value)

- PF3A801H (For 1000 L/min)

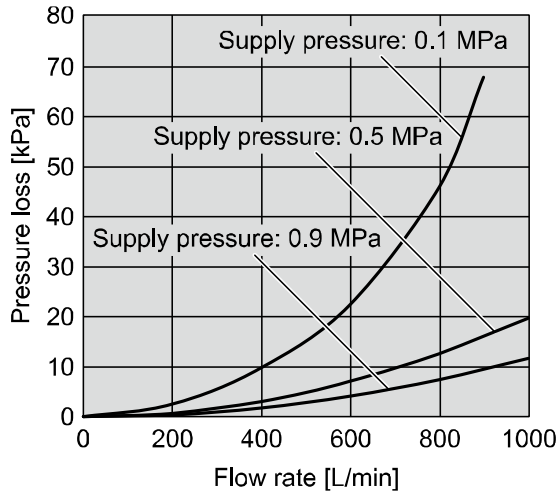

- PF3A5802H (For 2000 L/min)

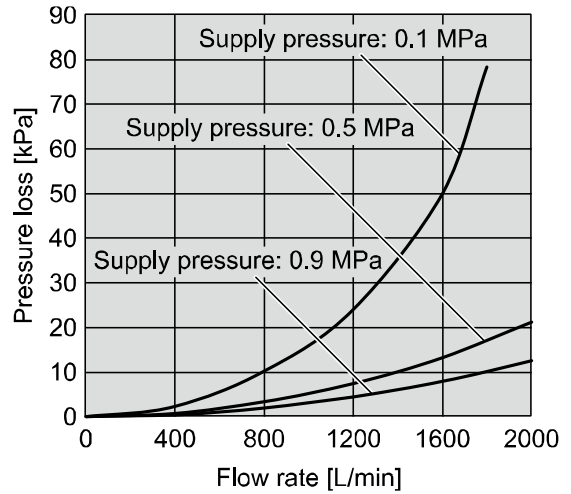

- Temperature accuracy (reference value)

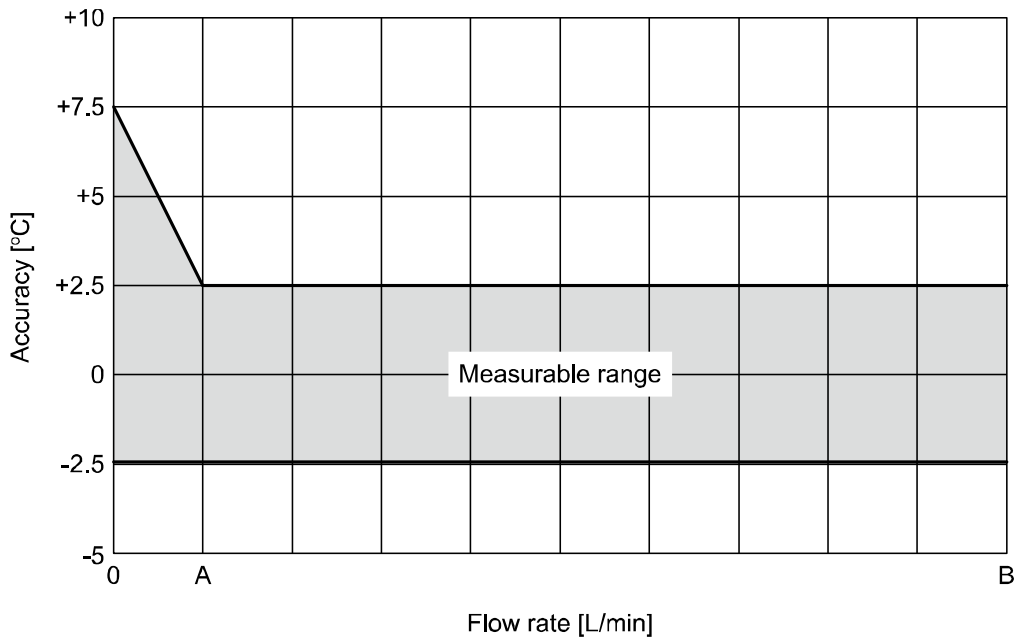

Models	A	B
PF3A801H	100 L/min	1000 L/min
PF3A802H	200 L/min	2000 L/min

■Dimensions

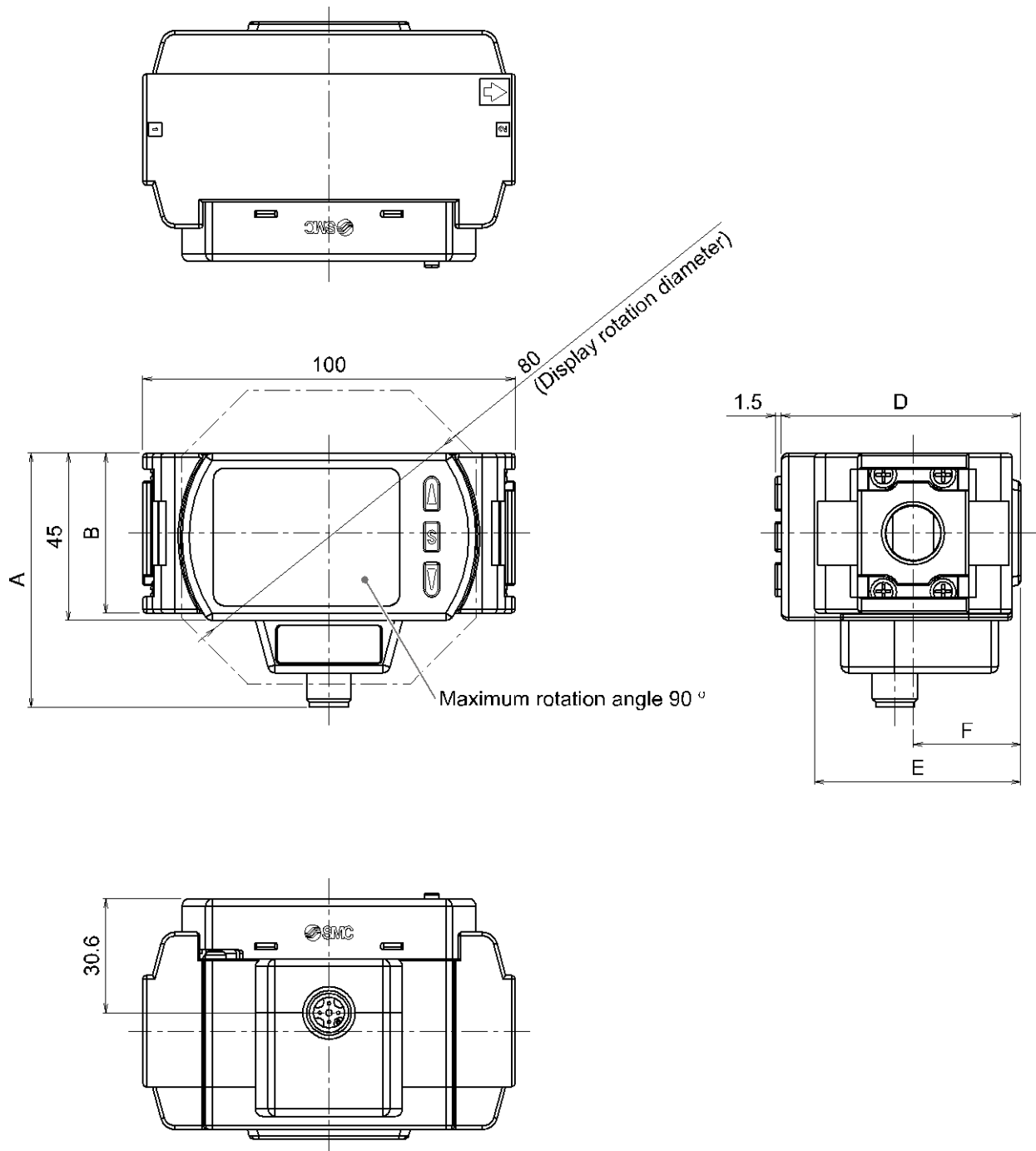

Models	Symbol	A	B	D	E	F
PF3A801H		68.3	43	64.4	55.4	28.9
PF3A802H		72.3	51	73	71	35.5

Lead wire with M12 connector (ZS-37-A)

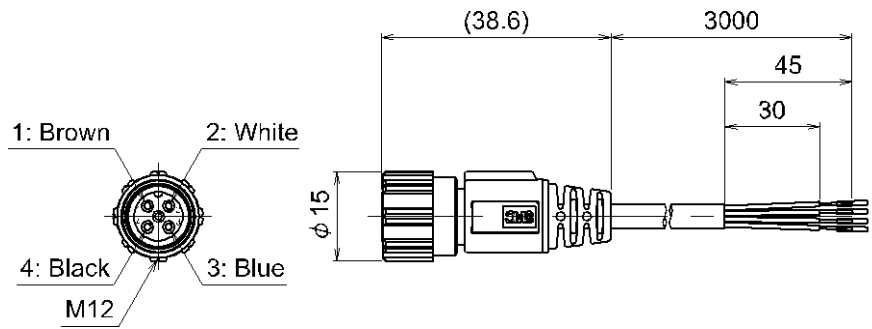

Pin number	Description	Colour
1	DC(+)	Brown
2	FUNC	White
3	DC(-)	Blue
4	OUT	Black

*: 4-wire lead wire with M12 connector for PF3A series.

Lead wire with M12 connector (ZS-49-A)

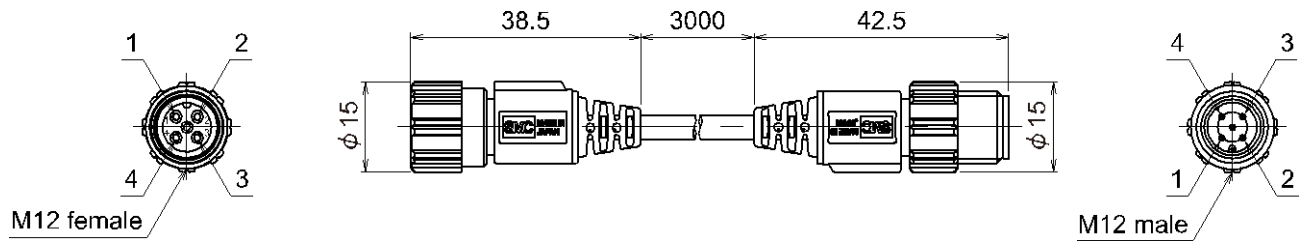

M12 female Pin number	Description	M12 male Pin number
1	L+	1
2	N.C. or DO	2
3	L-	3
4	C/Q	4

Revision history

A: Contents revised in several places [May 2022]
B: Contents revised in several places.
[November 2023]
C: Contents revised in several places [May 2024]

SMC Corporation

Tel: + 81 3 5207 8249 Fax: +81 3 5298 5362
URL <https://www.smcworld.com>