



# Operation Manual

PRODUCT NAME

*Rotary Table*

MODEL / Series / Product Number

*MSQ\*1 to 7*

**SMC Corporation**

# Contents

|  |    |
|--|----|
| <b>Safety Instructions</b>                           | 2  |
| <b>Outline</b>                                       | 18 |
| How to order   | 18 |
| <b>Specifications</b>                                | 19 |
| Weight   | 19 |
| Effective torque                                     | 19 |
| <b>Internal construction and parts</b>               | 20 |
| MSQ1 to 7  | 20 |
| <b>Basic circuit</b>                                 | 21 |
| Circuit structure                                    | 21 |
| Recommended models                                   | 21 |
| <b>Mounting</b>                                      | 22 |
| Load restrictions                                    | 22 |
| Unit used as flange mount                            | 22 |
| Direction and Angle of Rotation                      | 23 |
| Rotating range examples                              | 24 |
| Piping   | 25 |
| Air supply   | 25 |
| <b>Setting of rotation time</b>                      | 26 |
| Moment of inertia                                    | 26 |
| Calculation formulae for moment of inertia           | 27 |
| Kinetic energy                                       | 28 |
| <b>Auto switch</b>                                   | 29 |
| Internal structure and operation principle           | 29 |
| Mounting of auto switch                              | 29 |
| Auto switch proper mounting position at rotation end | 30 |
| <b>Maintenance and Inspection</b>                    | 31 |
| Regular check  | 31 |
| Interval of inspection                               | 31 |
| <b>Troubleshooting</b>                               | 32 |



# Safety Instructions

These safety instructions are intended to prevent hazardous situations and/or equipment damage. These instructions indicate the level of potential hazard with the labels of “**Caution**,” “**Warning**” or “**Danger**.” They are all important notes for safety and must be followed in addition to International Standards (ISO/IEC)<sup>\*1)</sup>, and other safety regulations.

\*1) ISO 4414: Pneumatic fluid power - General rules and safety requirements for systems and their components  
ISO 4413: Hydraulic fluid power - General rules and safety requirements for systems and their components  
IEC 60204-1: Safety of machinery - Electrical equipment of machines - Part 1: General requirements  
ISO 10218-1: Robots and robotic devices - Safety requirements for industrial robots - Part 1: Robots  
etc.



## **Danger**

**Danger** indicates a hazard with a high level of risk which, if not avoided, will result in death or serious injury.

## **Warning**

**Warning** indicates a hazard with a medium level of risk which, if not avoided, could result in death or serious injury.

## **Caution**

**Caution** indicates a hazard with a low level of risk which, if not avoided, could result in minor or moderate injury.

## **Warning**

### **1. The compatibility of the product is the responsibility of the person who designs the equipment or decides its specifications.**

Since the product specified here is used under various operating conditions, its compatibility with specific equipment must be decided by the person who designs the equipment or decides its specifications based on necessary analysis and test results. The expected performance and safety assurance of the equipment will be the responsibility of the person who has determined its compatibility with the product. This person should also continuously review all specifications of the product referring to its latest catalog information, with a view to giving due consideration to any possibility of equipment failure when configuring the equipment.

### **2. Only personnel with appropriate training should operate machinery and equipment.**

The product specified here may become unsafe if handled incorrectly. The assembly, operation and maintenance of machines or equipment including our products must be performed by an operator who is appropriately trained and experienced.

### **3. Do not service or attempt to remove product and machinery/equipment until safety is confirmed.**

1. The inspection and maintenance of machinery/equipment should only be performed after measures to prevent falling or runaway of the driven objects have been confirmed.
2. When the product is to be removed, confirm that the safety measures as mentioned above are implemented and the power from any appropriate source is cut, and read and understand the specific product precautions of all relevant products carefully.
3. Before machinery/equipment is restarted, take measures to prevent unexpected operation and malfunction.

### **4. Our products cannot be used beyond their specifications. Our products are not developed, designed, and manufactured to be used under the following conditions or environments. Use under such conditions or environments is not covered.**

1. Conditions and environments outside of the given specifications, or use outdoors or in a place exposed to direct sunlight.
2. Use for nuclear power, railways, aviation, space equipment, ships, vehicles, military application, equipment affecting human life, body, and property, fuel equipment, entertainment equipment, emergency shut-off circuits, press clutches, brake circuits, safety equipment, etc., and use for applications that do not conform to standard specifications such as catalogs and operation manuals.
3. Use for interlock circuits, except for use with double interlock such as installing a mechanical protection function in case of failure. Please periodically inspect the product to confirm that the product is operating properly.



# Safety Instructions

## **Caution**

**We develop, design, and manufacture our products to be used for automatic control equipment, and provide them for peaceful use in manufacturing industries.**

**Use in non-manufacturing industries is not covered.**

Products we manufacture and sell cannot be used for the purpose of transactions or certification specified in the Measurement Act.

The new Measurement Act prohibits use of any unit other than SI units in Japan.

## **Limited warranty and Disclaimer/Compliance Requirements**

The product used is subject to the following “Limited warranty and Disclaimer” and “Compliance Requirements”. Read and accept them before using the product.

### **Limited warranty and Disclaimer**

1. The warranty period of the product is 1 year in service or 1.5 years after the product is delivered, whichever is first.\*2)  
Also, the product may have specified durability, running distance or replacement parts. Please consult your nearest sales branch.
2. For any failure or damage reported within the warranty period which is clearly our responsibility, a replacement product or necessary parts will be provided.  
This limited warranty applies only to our product independently, and not to any other damage incurred due to the failure of the product.
3. Prior to using SMC products, please read and understand the warranty terms and disclaimers noted in the specified catalog for the particular products.

**\*2) Vacuum pads are excluded from this 1 year warranty.**

A vacuum pad is a consumable part, so it is warranted for a year after it is delivered.

Also, even within the warranty period, the wear of a product due to the use of the vacuum pad or failure due to the deterioration of rubber material are not covered by the limited warranty

### **Compliance Requirements**

1. The use of SMC products with production equipment for the manufacture of weapons of mass destruction (WMD) or any other weapon is strictly prohibited.
2. The exports of SMC products or technology from one country to another are governed by the relevant security laws and regulations of the countries involved in the transaction. Prior to the shipment of a SMC product to another country, assure that all local rules governing that export are known and followed.

# **Warning**

### **1. Confirm the specifications.**

Products represented in this catalog are designed only for use in compressed air systems.

Do not operate at pressures or temperatures, etc., beyond the range of specifications, as this can cause damage or malfunction. (Refer to the specifications.)

We do not guarantee against any damage if the product is used outside of the specification range.

### **2. If the operation involves load fluctuations, ascending/descending movements, or changes in friction resistance, make sure to provide safety measures.**

Operating speed will increase, and bodily injury may occur, or damage to the machinery itself may occur.

### **3. If there is a chance that the product will pose a hazard to humans, install a protective cover.**

If the moving portion of the product will pose a hazard to humans or will damage machinery or equipment, provide a construction that prevents direct contact with those areas.

### **4. Be certain that the secured portions will not loosen.**

Be certain to adopt a reliable connecting method if the rotary table is used very frequently or if it is used in a location that is exposed to a large amount of vibrations.

### **5. There may be cases in which a speed reduction circuit or a shock absorber is required.**

If the driven object moves at high speeds or is heavy, it will be unfeasible for only the rotary table's cushion to absorb the shock. Therefore, provide a speed-reduction circuit to reduce the rotary table's speed before the thrust is applied to the cushion, or an external shock absorber to dampen the shock. If these countermeasures are taken, make sure to take the rigidity of the mechanical equipment into consideration.

### **6. Consider the possibility of a reduction in the circuit air pressure caused by a power failure.**

When a rotary table is used as clamping mechanism, there is a danger of workpiece dropping if there is a decrease in clamping force, due to a drop in circuit pressure caused by a power failure. Therefore, safety equipment should be installed to prevent damage to machinery and bodily injury.

### **7. Consider the possibility of power source related malfunctions that could occur.**

For the machinery equipment that rely on power sources such as compressed air, electricity, or hydraulic pressure, adopt countermeasure to prevent the equipment from causing a hazard to humans or damage to the machinery and equipment in the event of malfunction.

### **8. If a speed controller is provided in the exhaust restrictor, implement a safety design taking the residual pressure into consideration.**

If air pressure is applied to the air supply side without residual pressure in the exhaust side, the rotary table will operate at abnormally high speeds, which could pose a hazard to humans and damage the machinery and equipment.

### **9. Consider the behavior of the rotary table in the event of an emergency stop.**

Devise a safe system so that if a person engages the emergency stop, or if a safety device is tripped during a system malfunction such as a power failure, the movement of the rotary table will not cause a hazard to humans or damage the equipment.

### **10. Consider the action of the rotary table when restarting after an emergency stop.**

Devise a safe design so that the restarting of the rotary table will not pose a hazard to humans or damage the equipment. Install manually controlled equipment for safety when the rotary table has to be reset to the starting position.

### **11. Do not use the product as a shock absorber.**

If an abnormal pressure or air leakage occurs, the rotary table's speed reduction capability could become severely affected, which could pose a hazard to humans and damage the machinery and equipment.

**12. Select a speed within the product's allowable energy value.**

If the product's kinetic energy of the load exceeds the allowable value, it could damage the product, and cause a hazard to humans and damage the machinery and equipment.

**13. Provide a shock absorber if the kinetic energy that is applied to the product exceeds the allowable value.**

If the product's kinetic energy exceeds the allowable value, it could damage the product, and cause a hazard to humans and damage the machinery or equipment.

**14. Do not stop or hold the product at midpoint by keeping air pressure in the product. (Air balancers etc.)**

For a product lacking an external stopping mechanism, if the directional control valve is closed to keep the air pressure in the product, in an attempt to stop the product at midpoint, it might not be possible to maintain that stopped position due to an air leakage. As a result, it could pose a hazard to humans and cause damage to machinery and/or equipment.

**15. Do not use two or more rotary tables with the aim of synchronized movement.**

One of the rotary tables may bear the load of operation, making synchronized movement impossible, and possibly leading to deformation of the equipment.

**16. Do not use in a location where adverse effect could be occurred by the oozing of the lubricant to the exterior.**

The lubricant coating the interior of the product may leak to the outside of the product from connecting parts of the rotary body, cover, etc.

**17. Do not disassemble the product or make any modifications, including additional machining.**

This may cause human injury and/or an accident.

**18. Refer to the Auto Switches Precautions for using with an auto switch.**

## **Caution**

**1. Do not use below the speed adjustment range specified for the product.**

If the product is used below the specified speed adjustment range, it could cause the product to stick, slip, or the movement to stop.

**2. Do not apply an external torque to the product that exceeds the rated output.**

If an external force that exceeds the product's rated output is applied to the product, it could damage the product.

**3. The holding torque of the rotating end of the double piston type**

If the internal piston of a double piston product comes in contact with the angle adjustment screen or the cover and stops, the holding torque at the rotating end is one half of the actual output.

**4. If it is necessary to provide repeatability of the rotation angle, directly stop the load externally.**

Even with a product that is equipped with an angle adjuster, there are times when the initial rotation angle could change.

**5. Do not use under hydraulic pressure.**

The product will be damaged if it is used by applying hydraulic pressure.

**6. There is a possibility of backlash being generated when stopping the double piston style in the middle with a valve of the closed center type.**

**7. Do not use in a places where there are many temperature fluctuations.**

**When using in lower temperature applications, use caution so that frost does not occur inside the cylinder or the piston rod.**

Operation may be unstable.

**8. Adjust the speed control in the environment in which it will be used in.**

Speed adjustment may be changed if the environment is different.

## Mounting

# Warning

### 1. Operation manual

Install the product and operate it only after reading the operation manual carefully and understanding its contents. Also, keep the manual in a location where it can be referred to as necessary.

### 2. Ensure sufficient space for maintenance activities.

When installing the products, allow access for maintenance.

### 3. Tighten threads with the proper tightening torque.

When installing the products, follow the listed torque specifications.

### 4. Before adjusting the angle by supplying air pressure, take appropriate measures to prevent the equipment from rotating unnecessarily.

When an adjustment is performed under air pressure, the equipment could rotate and fall during the adjustment, depending on the mounted posture of the equipment. As a result, it could pose a hazard to humans and damage the machinery and equipment.

### 5. Do not loosen the angle adjustment screw beyond the allowable adjustment range.

The angle adjustment screw could fall out if it is loosened beyond its allowable adjustment range, which could pose a hazard to humans and damage the machinery and equipment.

### 6. Do not place a magnetic object near the product.

The auto switch is a magnetic sensing type. If a magnetic object is placed close to it, the rotary table could operate suddenly, which could pose a hazard to humans and damage the machinery and equipment.

### 7. Do not perform additional machining to the product.

Additional machining to the product can result in insufficient strength and cause damage to the product. This can lead to possible human injury and damage to the surrounding equipment.

### 8. Do not enlarge the fixed throttle by modifying the pipe connectors.

If the hole diameter is enlarged, the product's rotation speed will increase, causing the shock force to increase and damage to the product. As a result, it could pose a hazard to humans and damage the machinery and equipment.

### 9. If shaft couplings are used, use those with angular freedom.

If shaft couplings that lack angular freedom are used, they could scrape due to eccentricity, leading to equipment malfunction and product damage. As a result, it could pose a hazard to humans and damage the machinery and equipment.

### 10. Do not apply to the shaft a load that exceeds the values given in a catalog.

If a load that exceeds the allowable value is applied to the product, it could lead to equipment malfunction, a hazard to humans and damage to the machinery and equipment. Provided that a dynamic load is not generated, a load that is within the allowable radial / thrust load can be applied. However, applications in which the load is applied directly to the shaft should be avoided whenever possible. The methods such as those described below are recommended to prevent the load from being applied directly to the shaft in order to ensure a proper operating condition.

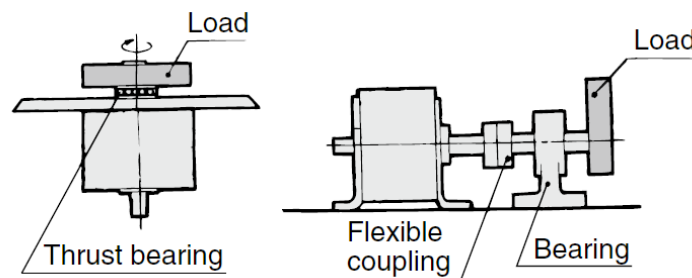

### 11. Do not use springs, etc., to add force in the rotational movement direction.

When rotational force from an external spring, etc., acts and generates negative pressure on the product's interior, breakage of the internal seal or acceleration of abrasion may occur.

## 12. Place an external stopper in a position that is away from the rotating table.

If the stopper is placed near the rotating table, the torque that is generated by the product itself will cause the reaction force which is directed to the stopper to be redirected and applied to the rotating table. This will lead to the breakage of the rotating table and bearing. As a result, it could pose a hazard to humans and damage the machinery and equipment.

### Precautions when Using External Stoppers

- Be sure to install external stoppers in the proper places. Installation in the wrong place can result in equipment breakage, which could damage other equipment or cause human injury.

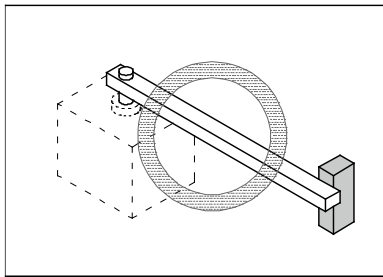

Install the stopper at a sufficient distance from the rotating shaft.

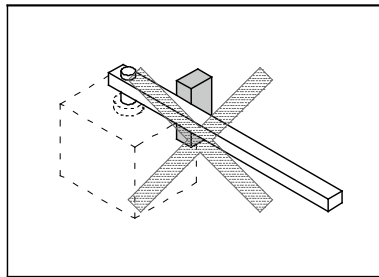

The external stopper becomes a fulcrum, resulting in the load's inertia force being applied to the table as a bending moment.

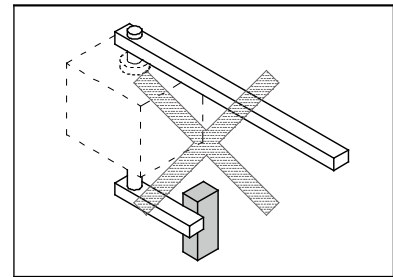

If an external stopper is installed on the opposite side of the load, the inertia force generated by the load is applied directly to the table.

- Install external stoppers within the range of the rotating angle.  
Installing an external stopper at the maximum rotation angle may result in an inability to fully absorb the kinetic energy generated, and damage to equipment may occur.
- Angle adjustment is available for this product. When using an external stopper, set in a position so that that the adjusting bolt does not collide into the piston.

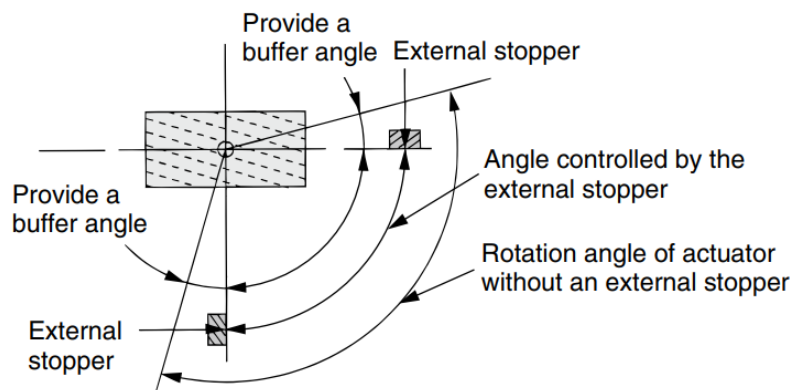

### Precautions when Converting Rotational Motion to Linear Motion

When using a link mechanism, etc., to convert rotational motion to linear motion, and determining the operation end using the stopper on the linear motion end (see below), a small value for  $\theta$  at the operation end may result in the torque of the rotary table causing excessive radial load to act on the output axle, and equipment breakage may occur.

Install a stopper on the rotation motion side, or increase the value of  $\theta$  at the operation end, to make sure the load generated does not exceed the allowable value for the product.

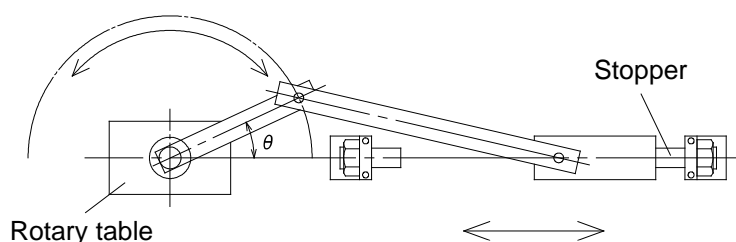



## Caution

1. **Do not use organic solvent to wipe the area of the name plate that shows the model.**  
It will erase what is indicated on the name plate.
2. **Do not hit the rotating table by securing the body or hit the body by securing the rotating table.**  
These actions could cause the table to bend or damage the bearing.
3. **Do not place your foot directly on the table or on the equipment that is coupled to the table.**  
Placing one's weight directly onto the rotating table could cause the rotating table or the bearing to become damaged.
4. **If a product is equipped with an angle adjustment function, use it within the specified adjustment range.**  
If the product is used outside the specified adjustment range, it could lead to equipment malfunction or product damage. Refer to the product specifications for details on the adjustment range of the products.
5. **A product with an angle adjustment screw is temporarily secured at an arbitrary position near the rotation end. Before using the product, readjust it to the desired angle and tighten the screw firmly.**

### Piping

## Caution

1. **Refer to the Fittings and Tubing Precautions (Best Automation No.9) for handling one touch fittings.**
2. **Preparation before piping**  
Before piping is connected, it should be thoroughly blown out with air (flushing) or washed to remove chips, cutting oil and other debris from inside the pipe.
3. **Wrapping of pipe tape**  
When screwing piping or fittings into ports, ensure that chips from the pipe threads or sealing material do not enter the piping. Also, if tape is used, leave 1.5 to 2 thread ridges exposed at the end of the threads.

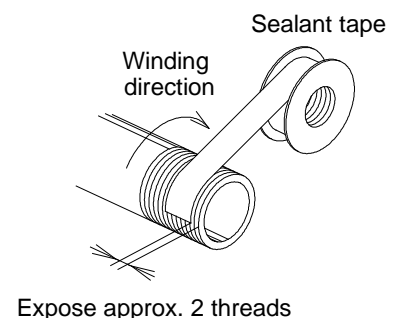

### Speed Adjustment

## Warning

1. **To make a speed adjustment, gradually adjust starting from the low speed end.**  
If the speed adjustment is performed from the high speed end, it could damage the product. As a result, it could pose a hazard to humans and damage the machinery and equipment.

## Lubrication

### **Warning**

1. **This product should be used without lubrication. Although it will operate even if it is lubricated, it could lead to sticking or slipping.**

## Air Supply

### **Warning**

1. **Type of fluids**

Use compressed air.

2. **When there is a large amount of moisture**

Compressed air containing a large amount of moisture can cause malfunction of pneumatic equipment. An air dryer or water separator should be installed upstream from filters.

3. **Drain flushing**

If condensation in the drain bowl is not emptied on a regular basis, the bowl will overflow and allow the condensation to enter the compressed air lines. This may cause malfunction of pneumatic equipment. If the drain bowl is difficult to check and remove, installation of a drain bowl with an auto drain option is recommended.

4. **Use clean air.**

Do not use compressed air that contains chemicals, synthetic oils including organic solvents, salt or corrosive gases, etc., as it can cause damage or malfunction.

### **Caution**

1. **When low dew point air is used as the fluid, degradation of the lubrication properties inside the equipment may occur, resulting in reduced reliability (or reduced service life) of the equipment.**

Please consider using low dew point products such as 25A-series.

2. **Install an air filter.**

Install an air filter upstream near the valve. Select an air filter with a filtration size of 5µm or smaller.

3. **Take measures to ensure air quality, such as by installing an aftercooler, air dryer, or water separator.**

Compressed air that contains a large amount of moisture can cause malfunction of pneumatic equipment such as rotary tables. Therefore, take appropriate measures to ensure air quality, such as by providing an aftercooler, air dryer, or water separator.

4. **Ensure that the fluid and ambient temperature are within the specified range.**

If the fluid temperature is 5°C or less, the moisture in the circuit could freeze, causing damage to the seals and equipment malfunction. Therefore, take appropriate measures to prevent freezing.

## Operating Environment

### **Warning**

1. **Do not use in an atmosphere having corrosive gases, chemicals, sea water, water, steam, or where there is direct contact with any of these.**  
Refer to the construction for information on the rotary table material.
2. **Do not expose the product to direct sunlight for an extended period of time.**
3. **Do not use in a place subject to heavy vibration and/or shock.**
4. **Do not mount the product in locations where it is exposed to radiant heat.**
5. **Do not use in dusty locations or where water oil, etc., splash on the equipment.**

## Maintenance

### **Warning**

1. **Perform maintenance inspection according to the procedures indicated in the operation manual.**  
If handled improperly, malfunction and damage of machinery or equipment may occur.
2. **Maintenance work**  
If handled improperly, compressed air can be dangerous. Assembly, handling, repair and element replacement of pneumatic systems should be performed by a knowledgeable and experienced person.
3. **Drain flushing**  
Remove drainage from air filters regularly.
4. **Removal of equipment, and supply/exhaust of compressed air**  
When components are removed, first confirm that measures are in place to prevent workpieces from dropping, run-away equipment, etc. Then, cut off the supply pressure and electric power, and exhaust all compressed air from the system using the residual pressure release function.  
When machinery is restarted, proceed with caution after confirming that appropriate measures are in place to prevent cylinders from sudden movement.

### **Caution**

1. **For lubrication, use the designated grease for each specific product.**  
The use of a non-designated lubricant could damage the seals.

## Auto Switches Precautions

### Design / Selection

## **Warning**

### 1. **Confirm the specifications.**

If the product is used with excess load applied or beyond the specification range, this may cause the product to break or malfunction. We do not guarantee against any damage if the product is used outside of the specification range.

### 2. **Cautions for use in an interlock circuit.**

When an auto switch is used for an interlock signal requiring high reliability, devise a double interlock system to avoid trouble by providing a mechanical protection function, or by also using another switch (sensor) together with the auto switch.

Also, perform regular maintenance and confirm proper operation.

### 3. **Do not attempt to disassemble, modify (including exchanging the printed circuit boards), or repair the product.**

An injury or failure can result.

## **Caution**

### 1. **Pay attention to the length of time that a switch is ON at an intermediate stroke position.**

When an auto switch is placed at an intermediate position of the stroke and a load is driven, at the time the piston passes the auto switch will operate, but if the speed is too great the operating time will be shortened and the load may not operate properly.

The maximum piston speed is:

$$V(\text{mm/s}) = \frac{\text{Auto switch operating range (mm)}}{\text{Load applied time (ms)}} \times 1000$$

### 2. **Take precautions when multiple rotary tables are used close together.**

When multiple auto switch rotary tables are used in close proximity, magnetic field interference may cause the auto switches to malfunction. Maintain a minimum cylinder separation of 40 mm. (When the allowable interval is specified for each cylinder series, use the indicated value.)

The auto switches may malfunction due to interference from the magnetic fields.

Use of a magnetic screen plate (MU-S025) or commercially available magnetic screen tape can reduce the interference of magnetic force.

### 3. **Ensure sufficient clearance for maintenance activities.**

When designing an application, be certain to allow sufficient clearance for maintenance.

### 4. **Do not mount rotary table with the auto switch on a footing.**

If work personnel gets on or puts the work personnel's foot on the footing accidentally, an excessive load is applied to the rotary table, causing the rotary table to break.

### 5. **Design the circuit so that any back-flow current does not flow in if a short-circuit trouble occurs or forced operation is performed to check the operation.**

If a back-flow current occurs, this may cause the switch to malfunction or break.

### 6. **When multiple auto switches are required.**

"n" indicates the number of auto switches which can be physically mounted on the rotary tables. Detection intervals depends on the auto switch mounting structure and set position, therefore some required interval and set positions may not be available.

### 7. **Limitations on detectable position**

There are positions or surfaces (bottom surface of the foot bracket, etc.) where the auto switch cannot be mounted due to the physical interference depending on the rotary table mounting status or mounting bracket. Select an appropriate auto switch setting position where the auto switch does not interfere with the rotary table mounting bracket (trunnion or reinforcing ring) after checking it sufficiently.

## 8. Provide enough space for the lead wire.

Applying stress to the lead wire and auto switch body connection part increases the risk of disconnection. Provide a space of at least the min. bending radius from the lead wire and auto switch body connection part.

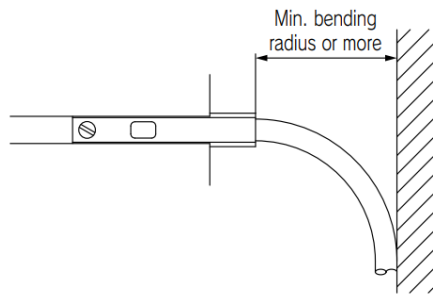

## 9. Keep wiring as short as possible.

### <Reed>

As the length of the wiring to a load gets longer, the rush current at switching ON becomes greater, and this may shorten the product's life. (The switch will stay ON all the time.)

- 1) Use a contact protection box when the wire length is 5m or longer.
- 2) Even if an auto switch has a built-in contact protection circuit, when the wiring is more than 30 m long, it is not able to adequately absorb the rush current and its life may be reduced.

### <Solid state>

Be sure to use a wire length 100m or less.

When the wire length is long, we recommend the ferrite core should be attached to the both ends of the cable to prevent excess noise. A contact protection box is not necessary for solid state switches due to the nature of this product construction.

## 10. Do not use a load that generates surge voltage.

### <Reed>

If a surge voltage is generated, the discharge occurs at the contact, possibly resulting in the shortening of product life.

If driving a load such as a relay that generates a surge voltage, use an auto switch with built-in contact protection circuit or use a contact protection box.

### <Solid state>

If driving a load such as a relay that generates a surge voltage, use a built-in surge absorbing element type device.

## 11. Pay attention to the internal voltage drop of the auto switch.

### <Reed>

- 1) Auto switch with an indicator light

- If auto switches are connected in series as shown below, take note that there will be a large voltage drop because of internal resistance in the light emitting diodes. (Refer to the internal voltage drop in the auto switch specifications.)

[The voltage drop will be "n" times larger when "n" auto switches are connected.]

Even though an auto switch operates normally, the load may not operate.

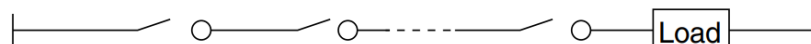

- In the same way, when operating under a specified voltage, although an auto switch may operate normally, the load may not operate. Therefore, the formula below should be satisfied after confirming the minimum operating voltage of the load.

$$\text{Supply voltage} - \text{Internal voltage drop of auto switch} > \text{Minimum operating voltage of load}$$

- 2) If the internal resistance of a light emitting diode causes a problem, select an auto switch without an indicator light.

#### <Solid state / 2-wire type>

Generally, the internal voltage drop of the solid state auto switch is larger than that of the reed auto switch. When the auto switches ("n" pcs.) are connected in series, the voltage drop is multiplied by "n". In this case, the auto switches operate correctly, but the loads may not operate. Additionally, note that the 12 VDC relay does not apply to the auto switch.

### 12. Pay attention to leakage current.

#### <2-wire type>

Current (leakage current) flows to the load to operate the internal circuit even when in the OFF state.

$$\text{Operating current of load (OFF condition)} > \text{Leakage current}$$

If the criteria given in the above formula are not met, it will not reset correctly (stays ON). Use a 3-wire switch if this specification will not be satisfied.

Moreover, leakage current flow to the load will be "n" times larger when "n" auto switches are connected in parallel.

### 13. Output operation of the solid state auto switch is not stable for 50 [ms] after powered ON.

In the output operation immediately after powered ON or AND connection operation, the input device (PCL or relay, etc.) may judge the ON position as OFF output or the OFF position as ON output. So, please make the setting on the equipment so that the input judgement signal is set disabled for 50 [ms] immediately after powered ON or AND connection. When using SMC's AHC system (Auto Hand Changing System) Series MA, please also make this setting.

## Mounting / Adjustment

### **Warning**

#### 1. Do not drop or bump.

Do not drop, bump or apply excessive impacts (300m/s<sup>2</sup> or more for reed auto switches and 1000m/s<sup>2</sup> or more for solid state auto switches) while handling. Although the body of the auto switch may not be damaged, the inside of the auto switch could be damaged and cause malfunction.

#### 2. Observe the proper tightening torque for mounting an auto switch.

When an auto switch is tightened beyond the range of tightening torque, auto switch mounting screws, auto switch mounting brackets or auto switch may be damaged.

On the other hand, tightening below the range of tightening torque may allow the auto switch to slip out of position.

#### 3. Do not carry a rotary table by the auto switch lead wires.

This may cause disconnection of the lead wire or the internal element to break.

#### 4. Do not use screws other than the set screws installed on the auto switch body to secure the auto switch.

If using other screws, auto switch may be damaged.

## 5. Mount an auto switch at the center of the operating range.

In the case of 2-color display auto switch, mount it at the center of the green LED illuminating range. Adjust the mounting position of the auto switch so that the piston stops at the center of the operating range. (The mounting position shown in the catalog indicates the optimum position at stroke end.) If mounted at the end of the operating range (around the borderline of ON and OFF), operation will be unstable depending of the operating environment. Also there are some rotary tables with individual setting methods for auto switches. If so, mount it in accordance with the indicated method.

**Even if 2-color indication solid state auto switches are fixed at a proper operating range (the green light lights up), the operation may become unstable depending on the installation environment or magnetic field disturbance.**

(Magnetic body, external magnetic field, proximal installation of rotary actuators with built-in magnet and actuators, temperature change, other factors for magnetic force fluctuation during operation, etc.)

## 6. Check the actual actuation status and adjust the auto switch mounting position.

According to the installation environment, the rotary table may not operate even at its proper mounting position. Even when setting at a midpoint of the stroke, check the actuation status and make the adjustment in the same manner.

## 7. Be very careful when handling the auto switch mounting band, as it has a thin structure.

### Wiring

## Warning

### 1. Confirm proper insulation of wiring.

If there is any improper insulation (mixed contact with other circuit, grounding fault, or improper insulation between terminals, etc.) in the wiring, an over-current flows in, causing the auto switch to break.

### 2. Wire separately from power lines of high voltage lines, avoiding parallel wiring of wiring in the same conduit with these lines.

If an inrush current is generated, the noise may cause the auto switch to malfunction.

### 3. Be certain to connect the load before power is applied.

#### <2-wire type>

If the power is turned ON when an auto switch is not connected to a load, the auto switch will be instantly damaged because of excess current (short circuit).

It is the same as when the 2-wire brown lead wire (+, output) is directly connected to the (+) power supply terminal.

### 4. Carry out the wiring work after shutting down the power.

If the wiring work is performed with the power turned ON, this may cause electric shock, malfunction, or damage to the auto switch.

## 5. Avoid repeatedly bending or stretching lead wires.

Broken lead wires will result from repeatedly applying bending stress or stretching force to the lead wires.

Stress and tensile force applied to the connection between the lead wire and auto switch increases the possibility of disconnection.

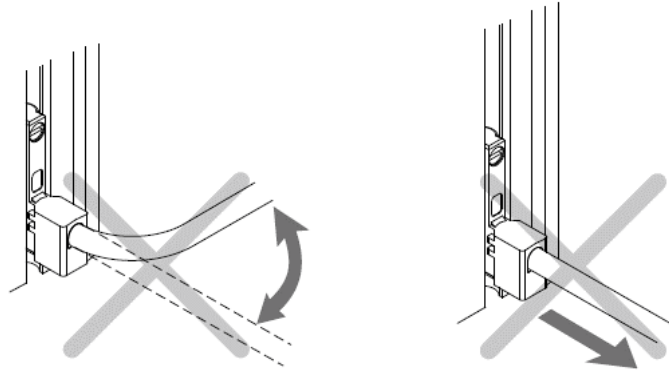

## 6. Do not allow short-circuit of loads.

### <Reed>

If the power is turned ON with a load in a short circuit condition, the switch will be instantly damaged because of excess current flow into the switch.

### <Solid state>

PNP output type auto switches do not have built-in short circuit protection circuits. Carefully handle as the auto switch may be damage.

## 7. Avoid incorrect wiring.

### <Reed>

A 24 VDC auto switch with indicator light has polarity. The brown lead wire or terminal No.1 is (+), and the blue lead wire or terminal No.2 is (-).

- 1) If connections are reversed, an auto switch will operate, however, the light emitting diode will not light up.

Also, take note that a current greater than that specified will damage a light emitting diode and it will no longer operate.

Applicable model: D-93, A93V

### <Solid state>

- 1) If connections are reversed on a 2-wire type auto switch, the auto switch will not be damaged if protected by a protection circuit, but the auto switch will always stay in an ON state. However, it is still necessary to avoid reversed connections, since the auto switch could be damaged by a load short circuit in this condition.
- 2) If connections are reversed (power supply line + and power supply line-) on a 3-wire type auto switch, the auto switch will be protected by a protection circuit. However, if the power supply line (+) is connected to the blue wire and the power supply line (-) is connected to the black wire, the auto switch will be damaged.

## 8. When the lead wire sheath is stripped, confirm the stripping direction. The insulator may be split or damaged depending on the direction. (D-M9□ only)

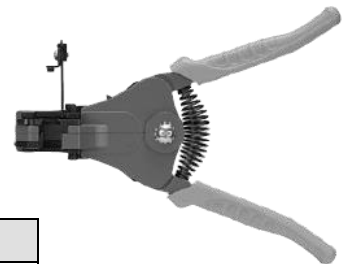
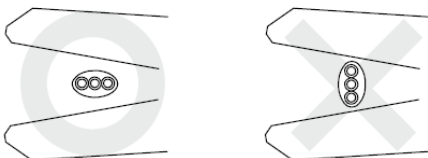

### Recommended Tool

| Description   | Model     |
|---------------|-----------|
| Wire stripper | D-M9N-SWY |

\* Stripper for a round cable (Ø2.0) can be used for a 2-wire type cable.



## Operation Environment

### **Warning**

**1. Never use in an atmosphere with explosive gases.**

The structure of auto switches is not intended to prevent explosion. This may lead to explosion hazard.

### **Caution**

**1. Do not use in an area where a magnetic field is generated.**

Auto switches will malfunction or magnets inside rotary tables will become demagnetized.

**2. Do not use in an environment where the auto switch will be continually exposed to water.**

Although auto switches satisfy IEC standard IP67 construction expect some models (D-A3□, A44□, G39□, K39□, RNK, RPK) do not use auto switches in applications where continually exposed to water splash or splay. This may cause improper insulation or malfunction.

**3. Do not use in an environment with oil or chemicals.**

If auto switches are used in an environment containing coolant, cleaning solvent, various oils, or chemicals even for a short period of time, this may adversely affect the auto switches, resulting in improper insulation, malfunction due to swelling of the potting resin, or hardening of the lead wires.

**4. Do not use in an environment with temperature cycles.**

If temperature cycles other than normal temperature changes are applied, this may adversely affect the insides of the auto switches.

**5. Do not use in an environment where there is excessive impact shock.**

**<Reed>**

When excessive impact ( $300\text{m/s}^2$  or more) is applied to a reed auto switch during operation, the contacts may malfunction and generate or cut off a signal momentarily (1ms or less).

**6. Do not use in an area where surges are generated.**

**<Solid state>**

If there is an equipment unit (electromagnetic lifter, high-frequency induction furnace, motor, or radio, etc.) that generates large surges or electromagnetic waves around cylinders with solid state auto switches or actuators, this may cause the circuit element inside the auto switch to break.

**7. Avoid accumulation of iron waste or close contact with magnetic substances.**

If many iron particles, such as cutting chips or spatters accumulate around a rotary table with the auto switches if a magnetic substance (attracted by a magnet) is put close to a rotary table with the auto switch, the magnetic force inside the rotary table loses, causing the auto switch to malfunction.

**8. Do not use in direct sunlight.**

**9. Do not mount the product in locations where it is exposed to radiant heat.**

**10. Take appropriate measures against the lightning surge on the equipment side as the auto switches do not have any lightning surge resistance specified in the CE marking.**

## Maintenance

### **Warning**

**1. Removal of equipment, and supply/exhaust of compressed air.**

Before any machinery or equipment is removed, first ensure that the appropriate measures are in place to prevent the fall or erratic movement of driven objects and equipment, then cut off the electric power and reduce the pressure in the system to zero. Only then should you proceed with the removal of any machinery and equipment.

When machinery is restarted, proceed with caution after confirming that appropriate measures are in place to prevent rotary tables from moving suddenly.

**2. Do not touch a terminal during energizing.**

Touching a terminal during energizing may cause electric shock, malfunction, or auto switch breakage.

### **Caution**

**1. Perform the following maintenance periodically in order to prevent possible danger due to unexpected auto switch malfunction.**

1) Secure and tighten auto switch mounting screws.

If screws become loose or the mounting, position is dislocated, retighten them after readjusting the mounting position.

2) Confirm that there is no damage to lead wires.

To prevent faulty insulation, replace auto switches or repair lead wires, etc., if damage is discovered.

3) Confirm the detection setting position.

•Red light of 1-color display auto switch

Confirm that the set position stops at the center of the operating range (red display area).

•Conform the green light and position of the 2-color display auto switch.

Conform that the set position stops at the center of the appropriate operating range (green display area). If stopped with the red LED lit, the operation may become unstable due to effects of the equipment environment or external disturbance. So, set the mounting position at the center of the appropriate operating range again.

**2. Do not use solvents such as benzene, thinner etc. to clean the product.**

They could damage the surface of the body and erase the markings on the body. For heavy stains, use a cloth lightly dampened with diluted neutral detergent, then wipe up any residue with a dry cloth.

## Handling Precautions

### **Caution**

**1. Do not remove the protective cover attached to the auto switch (D-A9 · (V)/Z7 · /Z80 type) product body until immediately before the product is to be mounted to the rotary table.**

The protective cover attached to the body of the D-A9 · (V)/Z7 · /Z80 type auto switch is intended to reduce impact during handling and prevent the auto switch holding screw from falling out.

In particular, it reduces impact to the auto switch body if it is accidentally bumped when mounting a connector or tubing to the auto switch, so do not remove it until immediately before mounting it to the rotary table.

# Outline

This operation manual explains "Rack and Pinion Type Rotary table".  
When using the product, load (moment of inertia), rotation time and other factors have to be considered.  
So, confirm the specification of the product prior to use.

## How to order

High precision type

MSQA 1 A [ ] - M9BW [ ]

Basic type

MSQB 1 A [ ] - M9BW [ ]

Size

|   |
|---|
| 1 |
| 2 |
| 3 |
| 7 |

Number of auto switches

|     |       |
|-----|-------|
| Nil | 2pcs. |
| s   | 1pc.  |
| n   | npcs. |

Auto switch type

|     |                                       |
|-----|---------------------------------------|
| Nil | Without auto switch (built-in magnet) |
|-----|---------------------------------------|

\*Refer to the table below for auto switch types.

A With adjustment bolt

Port location

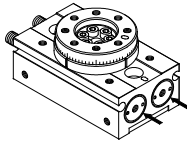
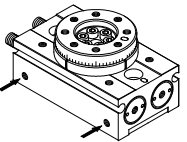
|     |   |
|-----|---|
| Nil | End port<br>    |
| E   | Front port<br> |

\*The port location cannot be changed after the delivery of the product.

## Applicable Auto Switches / Refer to the website catalog for detailed auto switch specification.

| Type                    | Special function                          | Electrical entry | Indicator light | Wiring (Output) | Load voltage |    | Auto switch model |             | Lead wire length (m) |                    |       |       | Pre-wire connector | Applicable load |            |   |
|-------------------------|---|------------------|-----------------|-----------------|--------------|----|-------------------|-------------|----------------------|--------------------|-------|-------|--------------------|-----------------|------------|---|
|                         |   |                  |                 |                 | DC           | AC | Perpendicular     | In-line     | 0.5 (Nil)            | 1 (M)              | 3 (L) | 5 (Z) |                    |                 |            |   |
| Solid state auto switch | —   | Grommet          | Yes             | 3-wire(NPN)     | 24V          | —  | M9NV              | M9N         | ●                    | ●                  | ●     | ○     | ○                  | IC circuit      | Relay, PLC |   |
|                         |   |                  |                 |                 |              |    | F8N               | —           | ●                    | —                  | ●     | ○     | —                  |                 |            |   |
|                         |   |                  |                 |                 |              |    | M9PV              | M9P         | ●                    | ●                  | ●     | ○     | ○                  |                 |            |   |
|                         |   |                  |                 | 3-wire(PNP)     |              |    | F8P               | —           | ●                    | —                  | ●     | ○     | —                  |                 |            |   |
|                         |   |                  |                 |                 |              |    | 2-wire            | M9BV        | M9B                  | ●                  | ●     | ●     | ○                  |                 |            | ○ |
|                         |   |                  |                 |                 |              |    |                   | F8B         | —                    | ●                  | —     | ●     | ○                  |                 |            | — |
|                         | Diagnostic indication (2-color indicator) | Grommet          | Yes             | 3-wire(NPN)     | 24V          | —  | M9NWV             | M9NW        | ●                    | ●                  | ●     | ○     | ○                  | IC circuit      |            |   |
|                         |   |                  |                 |                 |              |    | M9PWW             | M9PW        | ●                    | ●                  | ●     | ○     | ○                  | —               |            |   |
|                         |   |                  |                 |                 |              |    | 3-wire(PNP)       | M9BWW       | M9BW                 | ●                  | ●     | ●     | ○                  | ○               |            | — |
|                         |   |                  |                 |                 |              |    |                   | 2-wire      | M9NAV <sup>*1</sup>  | M9NA <sup>*1</sup> | ○     | ○     | ●                  | ○               |            | ○ |
|                         |   |                  |                 |                 |              |    | 3-wire(NPN)       |             | M9PAV <sup>*1</sup>  | M9PA <sup>*1</sup> | ○     | ○     | ●                  | ○               |            | ○ |
|                         |   |                  |                 |                 |              |    |                   | 3-wire(PNP) | M9BAV <sup>*1</sup>  | M9BA <sup>*1</sup> | ○     | ○     | ●                  | ○               |            | ○ |
| 2-wire                  |   |                  |                 |                 |              |    |                   |             |                      |                    |       |       |                    |                 |            |   |

\*1 Although it is possible to mount water resistant type auto switches, note that the rotary actuator itself is not of water resistant construction.

\*Lead wire length symbols : 0.5m ..... Nil  
1m ..... M  
3m ..... L  
5m ..... Z

\*Auto switches marked with a "O" are produced upon receipt of orders.

\*Refer to catalog for the details of solid state auto switch with pre-wired connector.

\*Auto switches are shipped together, (but not assembled).

Note 1) When using D-F8□, mount it at a distance of 10mm or more from magnetic substances such as iron.

## Specifications

Table 1. Specifications

| Size                           | 1                            | 2       | 3              | 7                |
|--------------------------------|------------------------------|---------|----------------|------------------|
| Fluid                          | Air (Non-lube)               |         |                |                  |
| Maximum operating pressure     | 0.7MPa                       |         |                |                  |
| Minimum operating pressure     | 0.1MPa                       |         |                |                  |
| Ambient and fluid temperature  | 0 to 60°C (with no freezing) |         |                |                  |
| Cushion                        | No cushion                   |         | Lubber cushion |                  |
| Allowable kinetic energy       | 0.001J                       | 0.0015J | 0.002J         | 0.006J           |
| Angle adjustment range         | 0 to 190°                    |         |                |                  |
| Maximum rotation               | 190°                         |         |                |                  |
| Rotation time adjustment range | 0.2 to 0.7 s/90°             |         |                | 0.2 to 0.1 s/90° |
| Cylinder bore size             | Ø 6                          | Ø 8     | Ø 10           | Ø 12             |
| Port size                      | M3x0.5                       |         |                | M5x0.8           |

## Weight

Table 2.

(g)

| Size                | 1  | 2   | 3   | 7   |
|---------------------|----|-----|-----|-----|
| Basic Type          | 75 | 105 | 150 | 250 |
| High precision Type | 80 | 115 | 165 | 265 |

\* Values excluding the weight of auto switch

## Effective torque

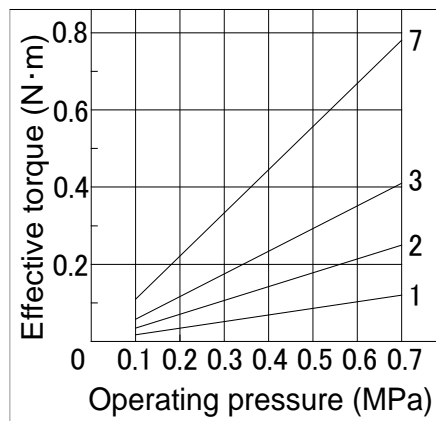

# Internal construction and parts

MSQ1 to 7

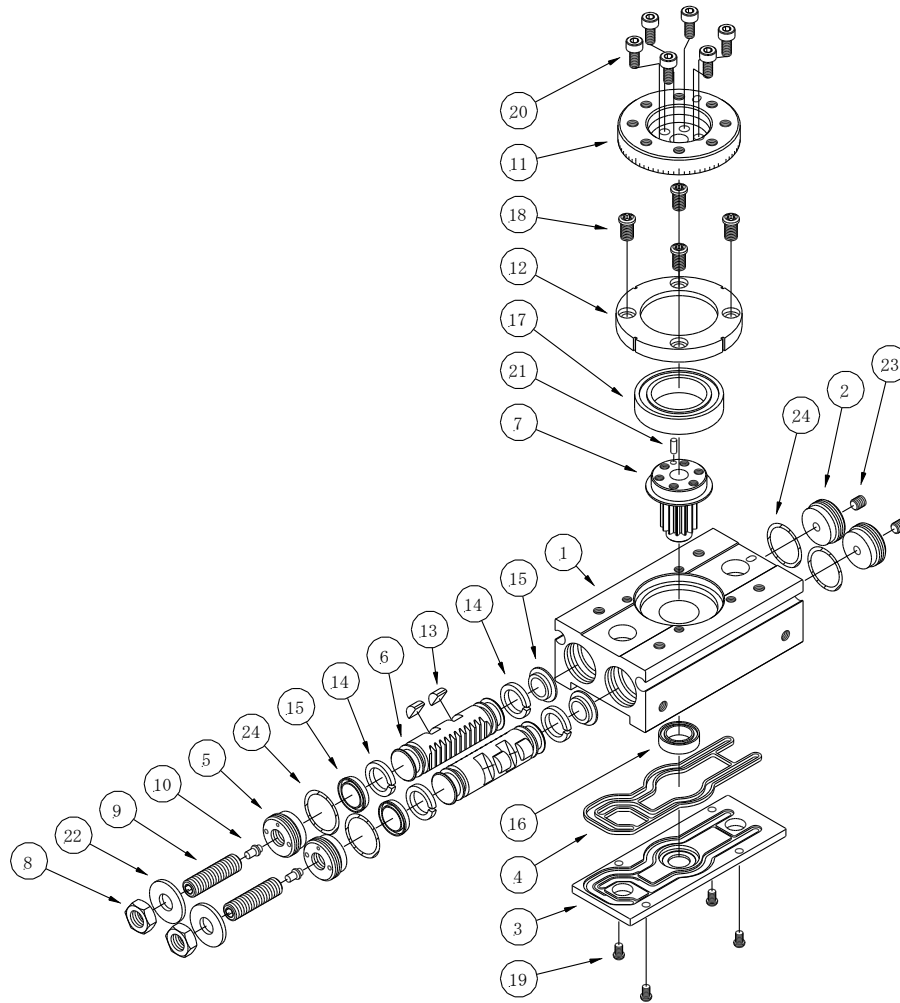

| 24 | O ring                        | 4   |                     |
|----|-------------------------------|-----|---------------------|
| 23 | Hexagon socket set screw      | 2   |                     |
| 22 | Seal washer                   | 2   |                     |
| 21 | Parallel pin                  | 1   |                     |
| 20 | Hexagon socket head set bolt  | 4   | 6pcs. for size 3, 7 |
| 19 | Round head Philips screw No.0 | 4   |                     |
| 18 | Round head Philips screw      | 4   | High precision type |
|    | Round head Philips screw      |     | Size : 7            |
|    | Round head Philips screw No.0 |     | Size : 1 to 3       |
| 17 | Special bearing               | 1   | High precision type |
|    | Deep groove ball bearing      |     | Basic type          |
| 16 | Deep groove ball bearing      | 1   |                     |
| 15 | Piston seal                   | 4   |                     |
| 14 | Wearing                       | 4   |                     |
| 13 | Magnet                        | 4   |                     |
| 12 | Bearing retainer              | 1   |                     |
| 11 | Table                         | 1   |                     |
| 10 | Cushion pad                   | 2   | Size : 3, 7         |
| 9  | Adjusting bolt                | 2   |                     |
| 8  | Hexagon nut                   | 2   |                     |
| 7  | Pinion                        | 1   |                     |
| 6  | Piston                        | 2   |                     |
| 5  | End cover                     | 2   |                     |
| 4  | Seal                          | 1   |                     |
| 3  | Plate                         | 1   |                     |
| 2  | Cover                         | 2   |                     |
| 1  | Body                          | 1   |                     |
| No | Description                   | Qty | Note                |

## Basic circuit

### Circuit structure

The standard circuit for operating a rotary cylinder with an air filter, regulator, solenoid valve and speed controller is shown in Figure 1 below.

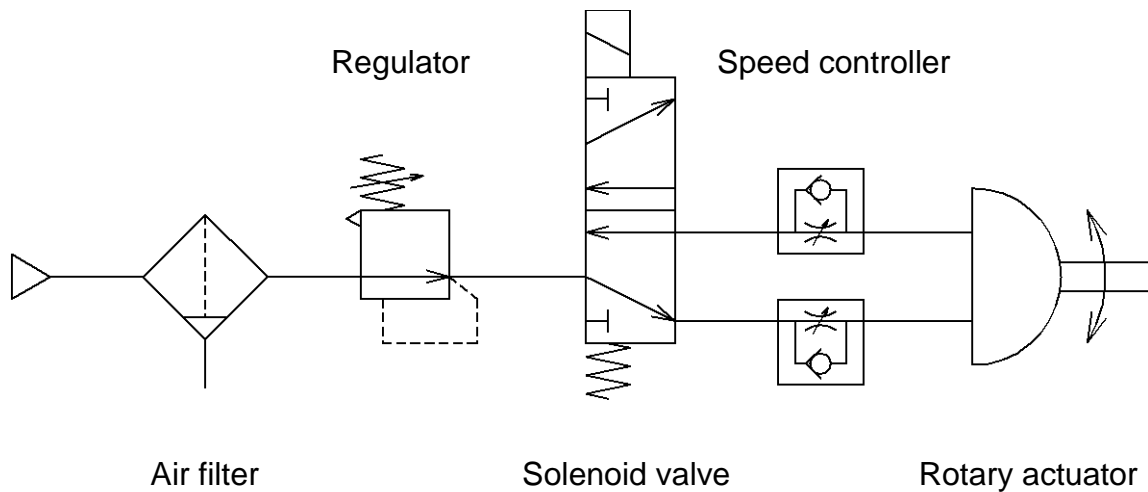

Fig.1 Basic circuit

### Recommended models

Recommended models for the standard circuit in Figure 1 are shown in Table 3 below.

Table 3. Recommended models

| Size | Solenoid valve<br>(CV value) | Speed controller | Tubing   |
|------|------------------------------|------------------|----------|
| 1    | 0.3                          | AS2000 series    | Ø4 / Ø 6 |
| 2    |                              |                  |          |
| 3    |                              |                  |          |
| 7    |                              |                  |          |

# Mounting

## Load restrictions

Set the load and moment to be applied to the table within the allowable values shown in the table below. (Values exceeding the allowable range will cause excessive play, reduce accuracy, and shorten service life.)

Table 4. Allowable load

| Size | Allowable radial load (N) | Allowable thrust load (N) |     | Allowable moment (N · m) |                     |
|------|---------------------------|---------------------------|-----|--------------------------|---------------------|
|      |                           | (a)                       | (b) | Basic type               | High precision type |
|      |                           | 1                         | 31  | 41                       | 41                  |
| 2    | 32                        | 45                        | 45  | 0.82                     | 1.2                 |
| 3    | 33                        | 48                        | 48  | 1.1                      | 1.6                 |
| 7    | 54                        | 71                        | 71  | 1.5                      | 2.2                 |

## Unit used as flange mount

Rotary table can be mounted from three directions-Two side of axial direction and one side of lateral face.

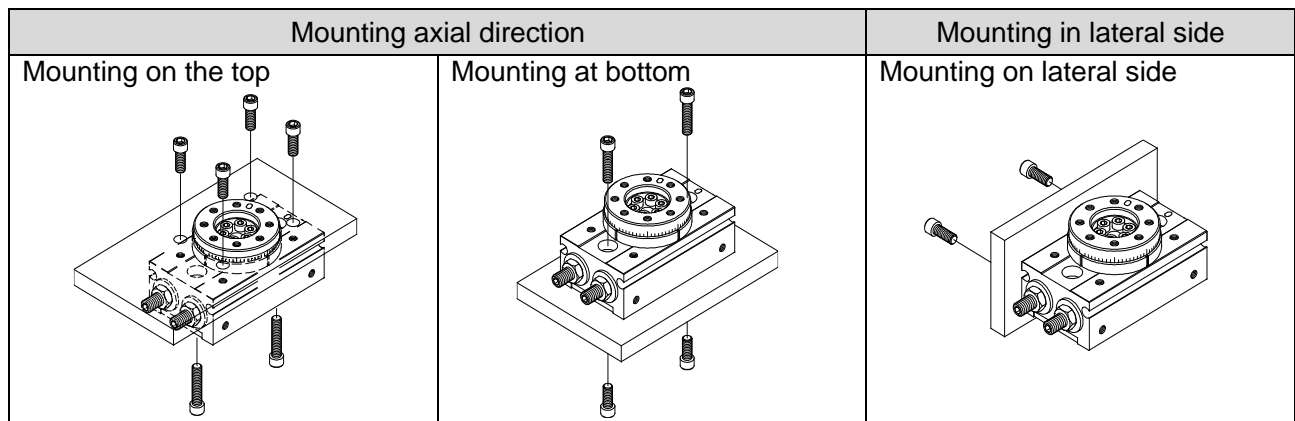

Table 5. Bolt size for mounting on axial direction

| Size | Bolt                |           |                     |                              |
|------|---------------------|-----------|---------------------|------------------------------|
|      | Mounting on the top |           | Mounting at bottom  |                              |
|      | Bolt                | Tap depth | When using body tap | When using body through hole |
| 1    | M3×0.5              | 3.5       | M4×0.7              | M3                           |
| 2    |                     |           |                     |                              |
| 3    |                     |           | M5×0.8              | M4                           |
| 7    |                     |           |                     |                              |

Table 6. Mounting on lateral side

| Size | Bolt   | Tap depth |
|------|--------|-----------|
| 1    | M4×0.7 | 4         |
| 2    |        |           |
| 3    |        |           |
| 7    | M5×0.8 | 5         |

**Rotation direction and rotation angle**

- When the cylinder is pressurized from port B, the table rotates clockwise.
- To obtain the desired rotation angle, the rotation ends can be set within the range shown in the diagram by regulating the adjustment bolt.

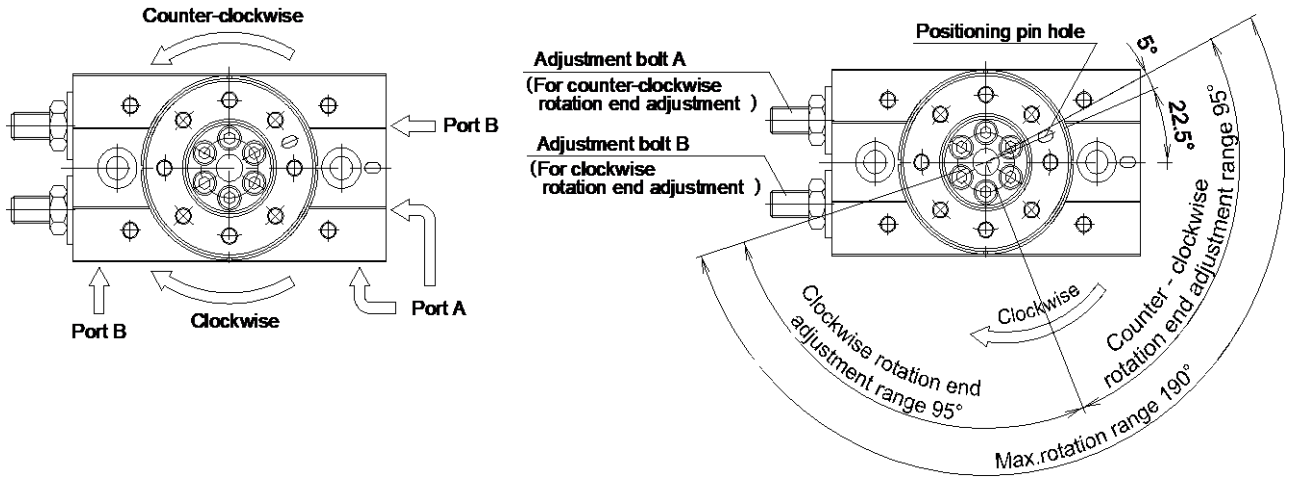

2b

Fig. 2

Note)

- The drawing shows the rotation range of the positioning pin hole.
- The pin hole position in the drawing shows anticlockwise rotation end when the rotation angle is set at 180° by equally tightening the adjusting bolts A and B.
- Refer to the setting example of the rotation angle range.

Table 7 shows adjusting angle per one rotation of adjust bolt.

Table 7 With adjustment bolt

| Size   | 1    | 2     | 3     | 7     |
|--|------|-------|-------|-------|
| Rotation adjustment per single rotation of rotation adjustment screw | 8.2° | 10.0° | 10.9° | 10.2° |



## Rotating range examples

Various rotation ranges are possible as shown in the drawings below using adjustment bolts A and B. (The drawings show the rotation range of the positioning pin hole.)

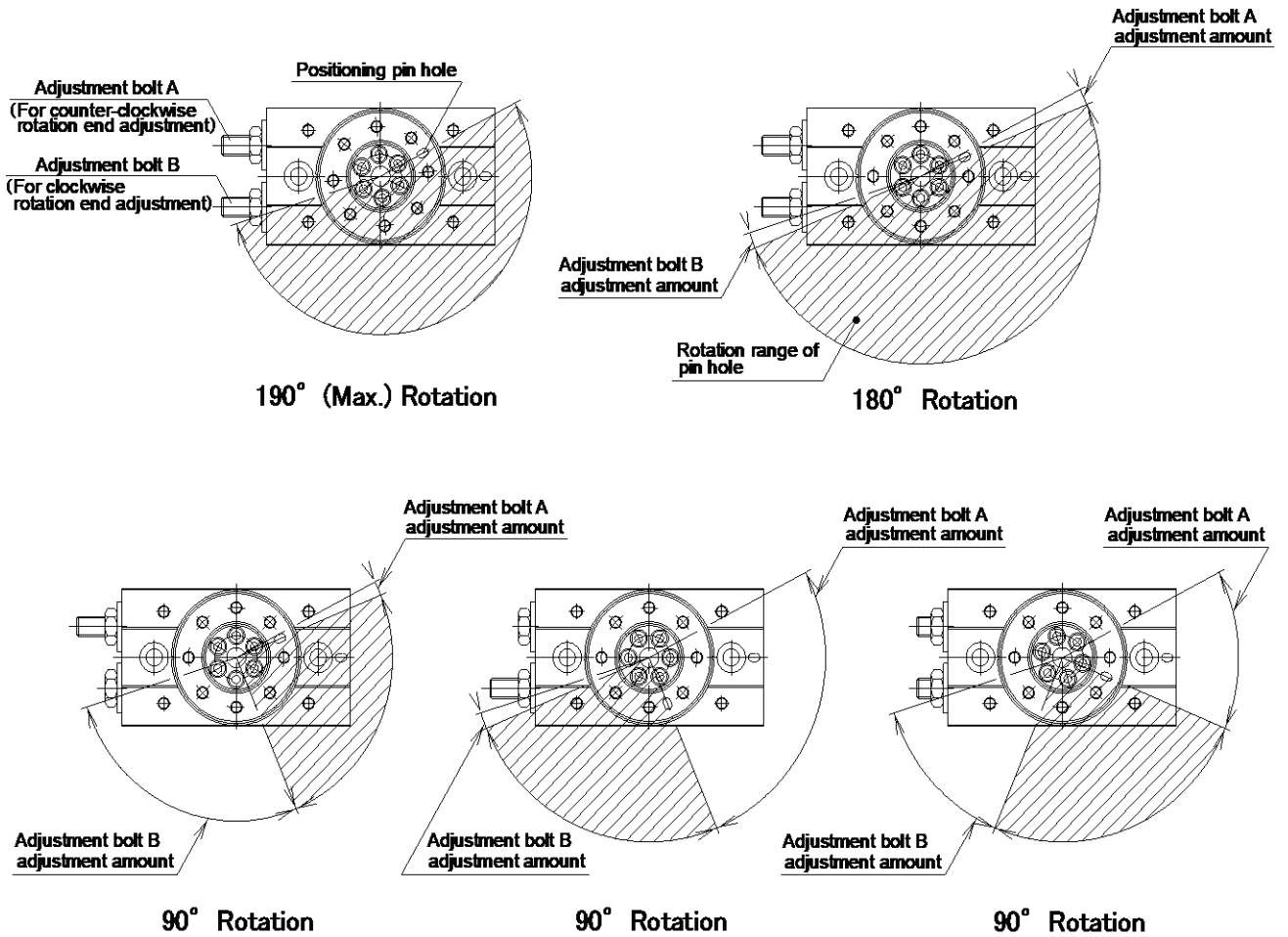

Fig. 3

## Piping

Figure 4 and Table 8 show locations and sizes of piping ports. Ports can be selected from two sides. Plug the ports that are not used.

Table 8 Port size

| Size | Port size  |           |
|------|------------|-----------|
|      | Front port | Side port |
| 1    | M3x0.5     |           |
| 2    |            |           |
| 3    |            |           |
| 7    | M5x0.8     |           |

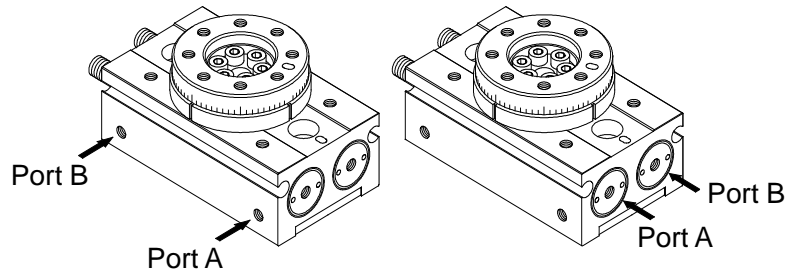

Fig. 4

Rotary table ports have a fixed orifice. Do not make the diameter of this hole larger by additional processing.

If the hole diameter is made larger, rotation speed and impact will increase, which may cause breakage of the product.

Preparation before piping.

- Before piping is connected, it should be thoroughly blown out with air to remove dust and scale from inside the pipe. Dust and scale on the inlet side of the filter can be removed, but those on the outlet side cannot be removed, so they can enter the solenoid valve or rotary table, which causes malfunction or shortens product life.
- When screwing piping or fittings into ports, ensure that chips from the pipe threads or sealing material do not enter the piping. Also, if pipe tape is used, leave 1.5 to 2 thread ridges exposed at the end of the threads.

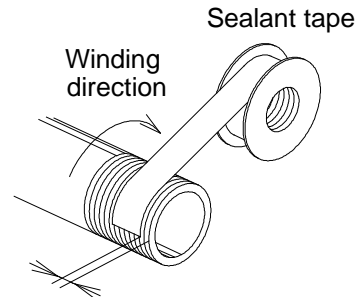

Expose approx. 2 threads

Fig. 5 Wrapping of pipe tape

## Air supply

Air supplied to the rotary actuator shall be cleaned by the filter. MSQ series is lubrication free.

## Setting of rotation time

It is necessary to calculate the inertial load and kinetic energy in the application prior to setting the speed of the actuator. The inertial load generated in the application may be high even if the torque required in the application is low, this may lead to damage to the internal components of the actuator.

### Moment of inertia

The moment of inertia indicates how hard it is to rotate an object, and also how hard it is to stop the object once it is rotating.

Any object rotated by a rotary table will have an inertial force.

When the rotary table stops at the stroke end, the actuator will receive a big impact (kinetic energy) due to the inertial force.

Please refer below for calculation of kinetic energy.

$$E = \frac{1}{2} \cdot I \cdot \omega^2$$

E: Kinetic energy [J]

I: Moment of inertia [ $kg \cdot m^2$ ]

$\omega$ : Angular speed [ $rad/s$ ]

Allowable kinetic energy for the rotary actuator is limited. The limit of rotation time is obtained by calculating the moment of inertia.

Please refer below to calculate the moment of inertia.

### Basic moment of inertia

$$I = m \cdot r^2$$

m : Weight [kg]

r : Center of gravity of load and distance of rotational axis [m]

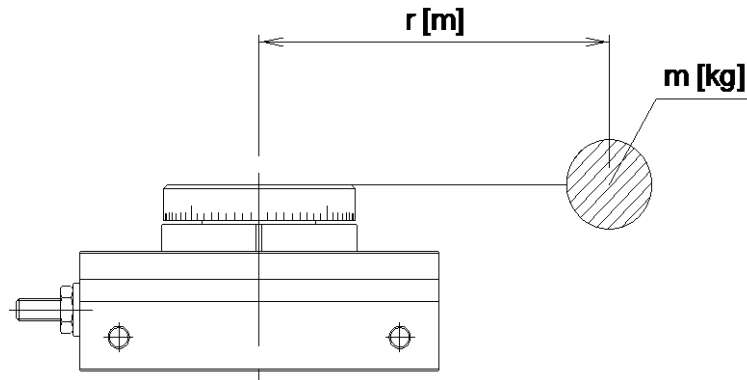

Fig. 6

This shows moment of inertia of "m (weight)" at "r" distance from the axis of rotation.

The calculation for the moment of inertia depends on the shape of the object.

Please refer the table on the next page for the moment of inertia calculations.

Calculation formulae for moment of inertia

I: Moment of inertia [ kg · m<sup>2</sup> ]    m: Load mass [ kg ]

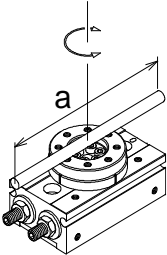
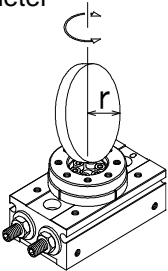
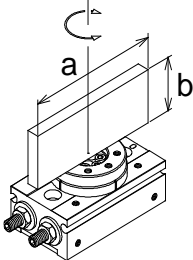
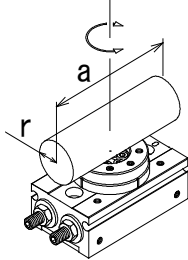
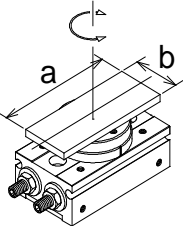
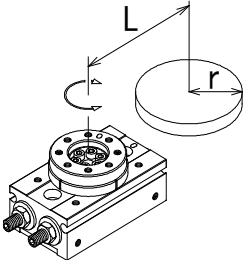
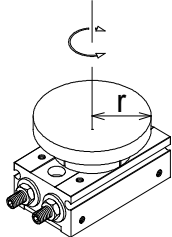
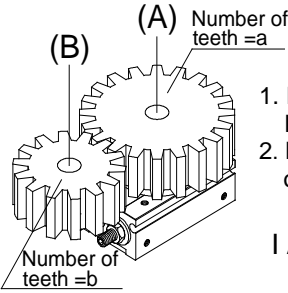
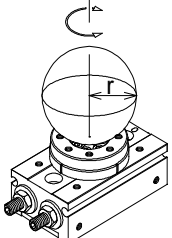
|   |  |
|---|--|
| <p><b>1. Thin shaft</b><br/>Position of rotational axis: Perpendicular to the shaft through the center of gravity</p>  $I = m \cdot \frac{a^2}{12}$  | <p><b>6. Thin round plate</b><br/>Position of rotational axis: Through the center of diameter</p>  $I = m \cdot \frac{r^2}{4}$   |
| <p><b>2. Thin rectangular plate</b><br/>Position of rotational axis: Parallel side b and through the center of gravity</p>  $I = m \cdot \frac{a^2}{12}$   | <p><b>7. Cylinder</b><br/>Position of rotational axis: Through the center of diameter and gravity</p>  $I = m \cdot \frac{3r^2 + a^2}{12}$   |
| <p><b>3. Thin rectangular plate (Including Rectangular parallelepiped)</b><br/>Position of rotational axis: Perpendicular to the plate through the center of gravity</p>  $I = m \cdot \frac{a^2 + b^2}{12}$ | <p><b>8. When the rotational axis and load center of gravity are not consistent</b></p>  $I = K + m \cdot L^2$ <p>K: Moment of inertia around the load center of gravity</p> <p>4.Round plate <math>K = m \cdot \frac{r^2}{2}</math></p>   |
| <p><b>4. Round plate (Including column)</b><br/>Position of rotational axis: Through the center axis</p>  $I = m \cdot \frac{r^2}{2}$  | <p><b>9. Gear transmission</b></p>  <ol style="list-style-type: none"> <li>1. Find the moment of inertia <math>I_B</math> for the rotation of shaft (B).</li> <li>2. <math>I_B</math> is converted to the rotation of the shaft (A).</li> </ol> $I_A = \left(\frac{a}{b}\right)^2 \cdot I_B$ |
| <p><b>5. Solid sphere</b><br/>Position of rotational axis: Through the center of diameter</p>  $I = m \cdot \frac{2r^2}{5}$  |  |

## Kinetic energy

Table 9 shows the allowable kinetic energy of the rotary table.

The end angular speed  $\omega$  is obtained by:

$$\omega = \frac{2\theta}{t}$$

$\theta$  : Rotation angle [ rad ]

$t$  : Rotation time [ s ]

Kinetic energy E is obtained by:

$$E = \frac{1}{2} \times I \times \omega^2$$

Table 9 Allowable kinetic energy (J)

| Size | Allowable kinetic energy |
|------|--------------------------|
| 1    | 0.001                    |
| 2    | 0.0015                   |
| 3    | 0.002                    |
| 7    | 0.006                    |

Therefore, the rotary table rotation time is:

$$t \geq \sqrt{\frac{2 \times I \times \theta^2}{E}}$$

E: Allowable kinetic energy [ J ]

$\theta$  : Rotation range [ rad ]

I: Moment of inertia [ kg · m<sup>2</sup> ]

During uniform acceleration, the angular acceleration  $\omega$  after  $t$  seconds can be found as follows.

$$\omega = \dot{\omega} \cdot t \quad \dots (1)$$

$$\theta = \dot{\omega} dt = \frac{1}{2} \dot{\omega} t^2 + C \quad \dots (2)$$

When  $t = 0$ , rotation angle  $\theta = 0$ , so the integration constant is  $C=0$ .

$$\theta = \frac{1}{2} \dot{\omega} t^2 = \frac{1}{2} \omega t$$

thus,

$$\omega = \frac{2\theta}{t}$$

## Auto switch type for rotary table

The rotary table has a magnet mounted on its piston and an auto switch on the outside of the body to detect the piston position (table position). Rotary tables have a short piston stroke, so detection should be done at the stroke end.

### Internal structure and operation principle

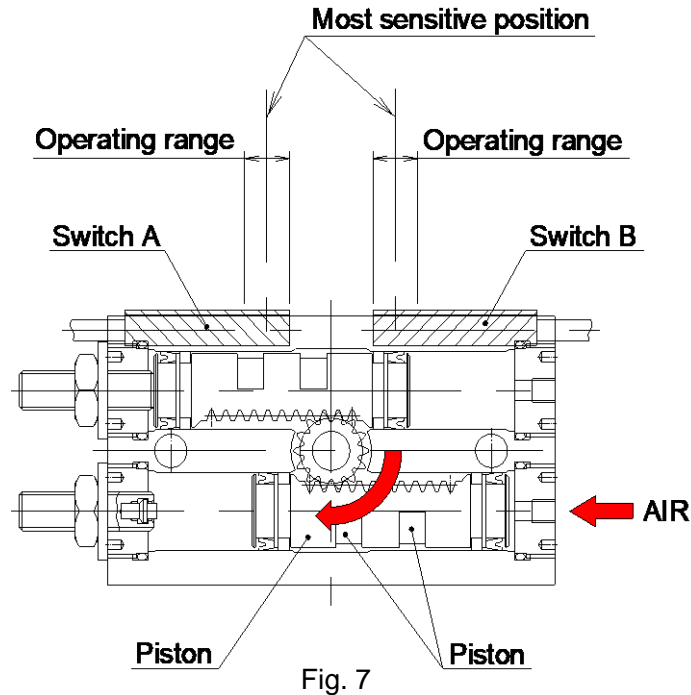

When switch A is turned on and pressure is supplied in the direction indicated by the arrows in Fig. 7, the piston moves and the table rotates clockwise.

At this point, magnet A goes out of switch A's operation range to turn off switch A. Then the piston moves further, and the magnet goes into switch B's operation range to turn on switch B.

### Mounting of auto switch

When tightening the auto switch mounting screw, use a precision screwdriver with a handle of 5 to 6 mm in diameter.

Table 10 shows the recommended tightening torque.

Use the designated slotted set screw (M2.5x4L) to mount the auto switch.

Table 10. Recommended tightening torque

| Auto switch model           | Recommended tightening torque [N · m] |
|-----------------------------|---------------------------------------|
| D-M9□                       | 0.05 to 0.15                          |
| D-M9□A<br>(Water resistant) | 0.05 to 0.10                          |
| D-F8□                       | 0.10 to 0.20                          |

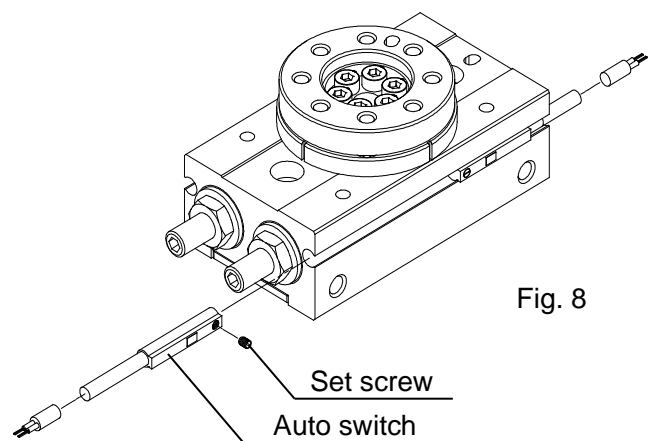

Auto switch proper mounting position at rotation end

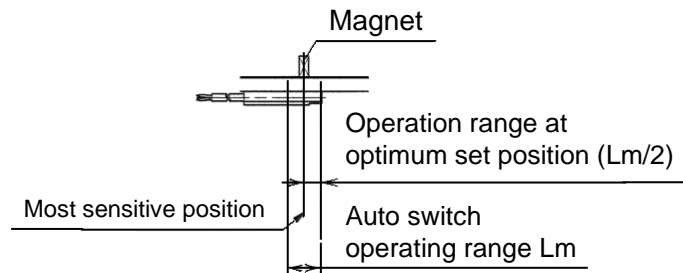
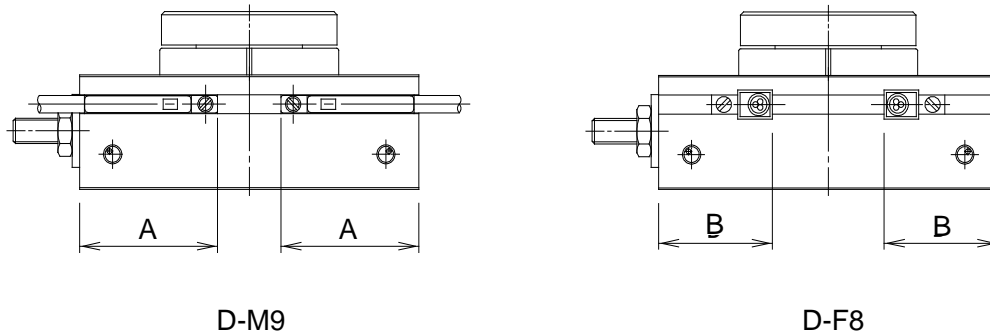

Fig. 9

Table 11 Auto Switch Rotation range / Actuation / most sensitive position

| Size | Rotation (deg) | Solid state switch |                                  |                       |                  |                                  |                       |
|------|----------------|--------------------|----------------------------------|-----------------------|------------------|----------------------------------|-----------------------|
|      |                | D-M9 Auto switch   |                                  |                       | D-F8 Auto switch |                                  |                       |
|      |                | A (mm)             | Operation range $\theta_m$ (deg) | Hysteresis range(deg) | B (mm)           | Operation range $\theta_m$ (deg) | Hysteresis range(deg) |
| 1    | 190            | 20.9               | 49                               | 10                    | 16.9             | 20                               | 10                    |
| 2    | 190            | 22.8               | 50                               | 10                    | 18.8             | 20                               | 10                    |
| 3    | 190            | 24.4               | 47                               | 10                    | 20.4             | 15                               | 10                    |
| 7    | 190            | 28.7               | 31                               | 10                    | 24.7             | 15                               | 10                    |

Operating range  $\theta_m$ : The value in which the auto switch operating range “ $L_m$ ” is converted to axis rotating value.

Hysteresis range : Value of auto switch hysteresis converted to an angle.

Note) The above values are only provided as a guideline, and they are not guaranteed.  
In the actual setting, adjust them after confirming the auto switch operating condition.

## Maintenance and Inspection

For most suitable use of rotary table, regular inspection is required according to the operating condition.

### ■ Regular check

Check the following for periodic inspection

- (1) Looseness of actuator mounting frame
- (2) Check rotation operation.
- (3) Check rotation angle and rotation position
- (4) External and internal leakage.
- (5) Looseness of stopper bolt, which is fixed by nut.
- (6) Check movement of switch ON/OFF.

If any items are found during the inspection that require repairing or tightening, either tighten the loose components or the rotary table must be replaced.

[Note: This item requires special tools, they cannot be disassembled. Please contact SMC for maintenance.]

### ■ Interval of inspection

To use rotary table series MSQ in the best condition, please check once or twice a year.



## Troubleshooting

| Problem                                  | Possible cause  | Solution  |
|--|---|---|
| Rotary table does not move               | Supply pressure is not applied correctly.                                   | Correctly set the regulator at the supply pressure side.  |
|  | The directional switching valve (such as a solenoid valve) does not switch. | Correctly apply a signal to the directional switching valve (such as a solenoid valve).   |
|  | Air leakage from piping.  | Inspect the piping and stop the leakage.  |
|  | The restrictor in the port is clogged.                                      | Clean the restrictor.<br>Take the following countermeasures:<br>(1) Blow air through the piping again.<br>(2) Inspect the air filter.   |
| Operation is not smooth.<br>(stick-slip) | The load has some friction.   | Reduce the friction resistance.   |
|  | The rotation table and the item used with it are not aligned.               | Align the two centers or use a flexible fitting.  |
|  | Insufficient output due to a low supply pressure.                           | To obtain stable operation, adjust the supply pressure to make the load ratio appropriate.  |
|  | Speed controller is restricted too much.                                    | Adjust the speed controller so that the rotating marks will be in the adjusting range.  |
| Extreme rotating angle changes.          | Internal parts are broken.  | Replace the rotary table with the new one.<br>After that, take the measures below. <ul style="list-style-type: none"> <li>• Calculate the kinetic energy applied to the rotary table and adjust the load and rotation speed to make the value within the allowable kinetic energy.</li> <li>• Mount an external stopper or shock absorber to absorb the impact force.</li> </ul> In this case, adjust so that the adjusting bolt does not come into contact with the piston. Set the rotation end with an external stopper. |

| Problem   | Possible cause  | Solution  |
|---|---|---|
| Air leakage from the table                                | Piston seal is worn out.  | The seal parts need to be replaced.<br>Contact SMC.   |
| The pinion gear is broken.                                | Excessive kinetic energy was applied to the rotary table.                         | Replace the rotary table with the new one.<br>After that, take the measures below.<br><ul style="list-style-type: none"> <li>• Calculate the kinetic energy applied to the rotary table and adjust the load and rotation speed to make the value within the allowable kinetic energy.</li> <li>• Mount an external stopper or shock absorber to absorb the impact force.</li> </ul> |
|   | Excessive external torque was applied to the rotary table.                        | In this case, adjust so that the adjusting bolt does not come into contact with the piston. Set the rotation end with an external stopper. • Do not apply external torque to the product that exceeds the rated output.   |
| Insufficient rotating Angle.                              | The adjustment bolt for angle adjustment is set at a smaller angle than required. | Set the adjustment bolt correctly.  |
| The auto switch will not operate or operates incorrectly. | The auto switch is mounted in an inappropriate position.                          | Mount the auto switch in the correct position.  |
|   | Effect of an external magnetic field.   | Check that there is no strong magnetic field present.   |
|   | Trouble with the electrical circuit   | Check that there is no trouble with the electrical circuit.   |
|   | Trouble with the electrical specification   | Check there is no trouble with the electrical specification.  |

Notes for the breakage and measurement list

1. Life of the equipment is excluded from cause of breakage.
2. If the cause is due to factor other than in the table, disassembling of the article may be required.  
In that case, please contact SMC.

#### Revision history

A: The contents have been revised to the latest version.

B: Revised safety instructions.

## SMC Corporation

Tel: + 81 3 5207 8249 Fax: +81 3 5298 5362

URL <https://www.smcworld.com>

---

Note: Specifications are subject to change without prior notice and any obligation on the part of the manufacturer.  
© SMC Corporation All Rights Reserved