



# Operation Manual

## Thermo Electric Bath

*HEBC002-WA10*

*HEBC002-WB10*



## SMC Corporation

Copying, duplicating or transferring any part or the entirety of this manual without the prior permission of SMC is strictly prohibited.

**Keep this manual available whenever necessary.**

## To the customers

Thank you for purchasing our Thermo Electric Bath HEB Series (hereinafter called “product”). SMC always strives to provide the highest quality high-performance temperature control devices to our customers by utilizing our original technology.

For the long-term and safe use of this product, be sure to read and understand this Operating Manual (hereinafter called “this manual”) thoroughly before use. Also, keep this manual available whenever necessary.

- 1) When the product is received, check the contents of the package immediately.

Packaging content

	Item	Qty.
1	Thermo Electric Bath (Liquid Tank)	1 pcs
2	Thermo Electric Bath (Controller)	1 pcs
3	Signal cable	1 pcs
4	DC cable	1 pcs
5	Power supply cable	1 pcs
6	Operation Manual	1 pcs

- 2) Observe the warnings and precautions defined in this manual.
- 3) This manual provides explanations of the installation and operation of this product. Only those who have a thorough understanding of the operating procedures and who have basic knowledge and skills in handling industrial equipment are qualified to perform installation and operation.
- 4) The contents of this manual and the related documents supplied with this product shall be neither regarded as a provision of the contract nor utilized to correct or modify the existing agreements, commitments and relations.
- 5) Copying, duplicating or transferring any part or the entirety of this manual without the prior permission of SMC is strictly prohibited.
- 6) This product has been developed for physical, chemical, and industrial facility applications. When it is used for applications that require the consideration additional safety precautions, e.g., for medical devices, investigate the safety needs for the application at the customer’s site before use.

**Note: The contents of this manual are subject to change without notice.**

---

# Table of Contents

<b>Chapter 1 Safety Instructions .....</b>	<b>1-1</b>
<b>1.1 Dangers, Warnings, and Cautions Used in This Manual .....</b>	<b>1-1</b>
1.1.1 Hazard Levels .....	1-1
1.1.2 Definitions of "Serious injury" and "Minor injury" .....	1-2
1.1.3 Symbols .....	1-2
<b>1.2 Hazard Warning Labels .....</b>	<b>1-4</b>
1.2.1 Location of hazard warning labels .....	1-5
<b>1.3 Location of Model Label .....</b>	<b>1-7</b>
<b>1.4 Safety Measures .....</b>	<b>1-8</b>
1.4.1 Precautions .....	1-8
1.4.2 Protective Equipment .....	1-9
1.4.3 Long-term Storage .....	1-10
1.4.4 Disposing of Product .....	1-10
<b>1.5 Interlock List .....</b>	<b>1-10</b>
<b>Chapter 2 Description and Function of Each Part .....</b>	<b>2-1</b>
<b>2.1 Liquid Tank/Controller .....</b>	<b>2-1</b>
<b>Chapter 3 Composition and Function of Product .....</b>	<b>3-1</b>
<b>3.1 Composition .....</b>	<b>3-1</b>
3.1.1 Outline .....	3-1
3.1.2 Operating Principles .....	3-3
<b>3.2 Function .....</b>	<b>3-5</b>
3.2.1 Auto Tuning Function .....	3-5
3.2.2 Temperature Upper / Lower Deviation Limit Alarm Function (at shipment) .....	3-5
3.2.3 Offset Function .....	3-7
3.2.4 Set Value Memory (EEPROM back-up) .....	3-7
3.2.5 Output cutoff Alarm Function .....	3-7
3.2.6 Alarm Indication on Operation and Display Panel .....	3-8
3.2.7 Communication Function .....	3-9
<b>Chapter 4 Set-up .....</b>	<b>4-1</b>
<b>4.1 Set-up, Transport and Transfer .....</b>	<b>4-1</b>
4.1.1 Transport and Transfer .....	4-1
4.1.2 Environment .....	4-1
4.1.3 Set-up in Clean Room .....	4-2
<b>4.2 Piping .....</b>	<b>4-2</b>
4.2.1 Preparation of Cooling Water .....	4-2
4.2.2 Quality of Cooling Water .....	4-5

**Table of Contents**

4.2.3	Preparation of Recirculating Fluid .....	4-6
4.2.4	Draining the Recirculating Fluid.....	4-7
<b>4.3</b>	<b>Wiring.....</b>	<b>4-9</b>
4.3.1	Earth Leakage .....	4-9
4.3.2	Power Supply.....	4-9
4.3.3	Grounding .....	4-10
4.3.4	Avoidence of Parallel Wiring.....	4-10
4.3.5	Incorrect Wiring.....	4-10
4.3.6	Removal of Cables .....	4-10
4.3.7	Connection of Various Types of Connectors and Power Supply Plugs .....	4-11
<b>4.4</b>	<b>Installation.....</b>	<b>4-11</b>
<b>Chapter 5 Operation .....</b>		<b>5-1</b>
<b>5.1</b>	<b>Start of Operation .....</b>	<b>5-1</b>
<b>5.2</b>	<b>Setting of Values .....</b>	<b>5-2</b>
<b>5.3</b>	<b>Cautions for Operation Control.....</b>	<b>5-2</b>
<b>5.4</b>	<b>Operation of Controller .....</b>	<b>5-4</b>
5.4.1	Details of Operation and Display Panel.....	5-4
5.4.2	Setting of Data .....	5-5
5.4.3	Selection of Operation Mode .....	5-6
5.4.4	Details of Operation Mode.....	5-7
5.4.5	Selection of Setting Mode.....	5-9
5.4.6	Selection of Initial Setting Mode .....	5-10
5.4.7	Details of Initial Setting Mode .....	5-10
5.4.8	Selection of Control Setting Mode .....	5-12
5.4.9	Details of Control Setting Mode.....	5-12
5.4.10	Selection of EV Output Setting Mode.....	5-15
5.4.11	Details of EV Output Setting Mode.....	5-15
5.4.12	Selection of Communication Setting Mode.....	5-18
5.4.13	Details of Communication Setting Mode .....	5-18
5.4.14	Initial Value and Setting Range for Each Mode .....	5-20
<b>5.5</b>	<b>Alarms.....</b>	<b>5-21</b>
5.5.1	Content of Alarms .....	5-21
5.5.2	Troubleshooting .....	5-23
<b>Chapter 6 Maintenance.....</b>		<b>6-1</b>
<b>6.1</b>	<b>Before returning the product.....</b>	<b>6-1</b>
<b>Chapter 7 Appendix .....</b>		<b>7-1</b>
<b>7.1</b>	<b>Outline Dimensions .....</b>	<b>7-1</b>
7.1.1	Liquid Tank.....	7-1
7.1.2	Controller .....	7-1

<b>7.2</b>	<b>Specifications</b> .....	<b>7-2</b>
<b>7.3</b>	<b>Specifications of Connectors</b> .....	<b>7-5</b>
7.3.1	Connection of Liquid Tank and Controller .....	7-5
7.3.2	Connection of Power Supply Cable .....	7-6
7.3.3	Connector for External Equipment.....	7-7
<b>7.4</b>	<b>Communication</b> .....	<b>7-8</b>
7.4.1	Specifications .....	7-8
7.4.2	Communication Procedure.....	7-8
7.4.3	Type of Message .....	7-9
7.4.4	Content of Communication.....	7-9
7.4.5	Composition of Required Message (from master to the product) .....	7-10
7.4.6	Composition of Response Message (from the product to master) .....	7-11
7.4.7	Explanation of Code .....	7-12
7.4.8	Cautions for Communication .....	7-14
7.4.9	Communication Example .....	7-16
7.4.10	Connection (for RS-485) .....	7-17
7.4.11	Identification Code List.....	7-18
7.4.12	ASCII Code List.....	7-18
<b>7.5</b>	<b>Performance Chart</b> .....	<b>7-19</b>
7.5.1	Cooling Capacity .....	7-19
7.5.2	Heating Capacity .....	7-20
7.5.3	Cooling Water Pressure Loss.....	7-21
<b>7.6</b>	<b>Calculation of Dew Point Temperature (from psychrometric chart)</b> .....	<b>7-22</b>
<b>Chapter 8</b>	<b>Warranty</b> .....	<b>8-1</b>



# Chapter 1 Safety Instructions



Be sure to thoroughly read and understand the important precautions defined in this manual before using this product.

## 1.1 Dangers, Warnings, and Cautions Used in This Manual

### 1.1.1 Hazard Levels

This product is designed with the safety of workers and the prevention of system damage as its first priority. This manual classifies the risks into the following three categories according to the severity and level of the hazard: Danger, Warning, and Caution. Read these statements carefully, and ensure that you thoroughly understand them before operating this product.

DANGER, WARNING and CAUTION signs follow this order according to hazard severity (DANGER > WARNING > CAUTION). See below for details.

#### **DANGER**

"DANGER" denotes that there is an imminent hazard which will cause serious personal injury or death during operation.

#### **WARNING**

"WARNING" denotes that there is a hazard which may cause serious personal injury or death during operation.

#### **CAUTION**

"CAUTION" denotes that there is a hazard which may cause minor personal injury during operation.

#### **CAUTION**

"CAUTION" without an exclamation point denotes that there is a hazard which may cause damage to or the failure of the system, facility, or devices.

#### [Tips]

Tips are provided when there is information and content that personnel are required to be aware of and refer to for product operation and maintenance of this product.

### 1.1.2 Definitions of “Serious injury” and “Minor injury”

■ **“Serious injury”**

This term describes injuries such as the loss of eyesight, wounds, burns, frostbite, electric shock, fractures, and toxicity that leave aftereffects, and/or injury requiring hospitalization and/or a prolonged stay in a hospital.

■ **“Minor injury”**

This term describes injuries that do not require hospitalization or a prolonged stay in a hospital (injuries other than the “serious injuries” described above).

### 1.1.3 Symbols

This manual provides the following symbols in addition to “Danger”, “Warning”, and “Caution” to present warning details in an easy-to-understand manner.

■ **Symbol of electrical hazard**

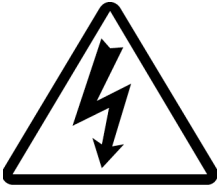

**This symbol warns you of potential electrical shock.**

■ **Symbol of heat hazard**



**This symbol warns you of potential burns.**

■ **Symbol of low temperature hazard**



**This symbol warns you of potential frostbite.**



■ **Symbol for corrosion**



This symbol warns of chemical corrosion. When handling chemical fluids, read the MSDS carefully and use appropriate protective equipment.

■ **Symbol for inhalation**



This symbol warns of chemical inhalation. When handling chemical fluids, read the MSDS carefully and use appropriate protective equipment.

■ **“Don’t” Symbol**



This symbol denotes actions which you must not perform in the operation of this product.

■ **“Do” Symbol**



This symbol denotes actions which you must perform and items you must observe in the operation of this product.

## 1.2 Hazard Warning Labels

Hazard warning labels are applied to the sections of this system in which potential hazards are present during system operation and maintenance.

Hazard warning labels are presented in sizes and colors that will get the attention of the worker. They contain symbols in addition to the descriptions of warnings.

### **WARNING**



- Do not peel off or deface the hazard warning labels.

### **WARNING**



- Confirm the locations of the hazard warning labels.
- Read the contents of the hazard warning labels carefully and keep them in mind.

### **WARNING**



- Users are NOT allowed to change the locations of the hazard warning labels. If replacing a peeled off or worn out label, affix the new label to exactly the same location as the replaced label.

## 1.2.1 Location of hazard warning labels

### ■ Liquid Tank

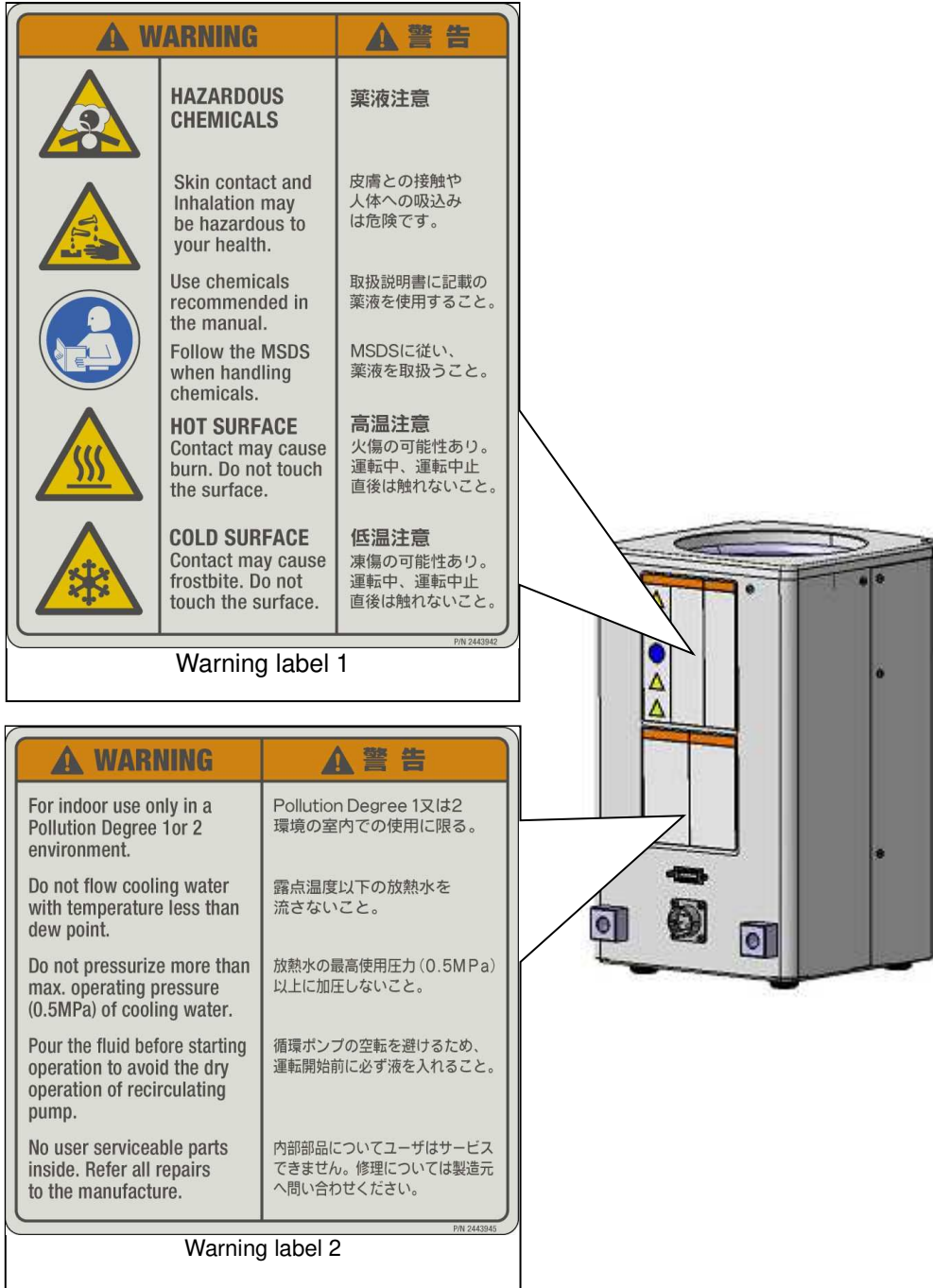

Fig. 1-1 Liquid Tank

■ Controller

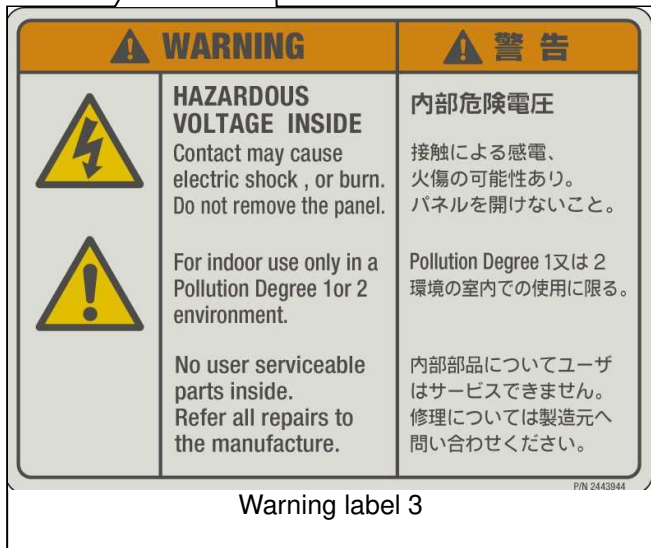
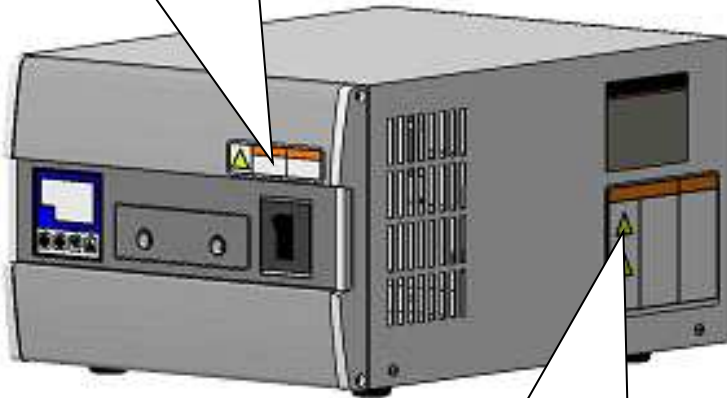
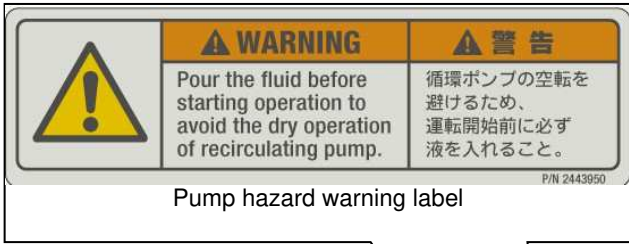

Fig. 1-2 Controller

### 1.3 Location of Model Label

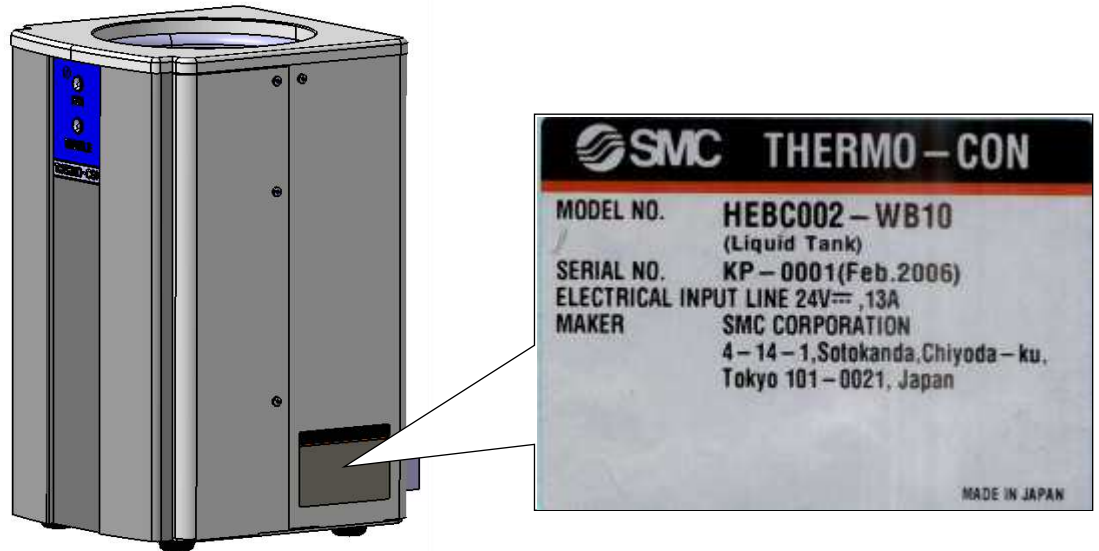

Fig. 1-3 Liquid Tank

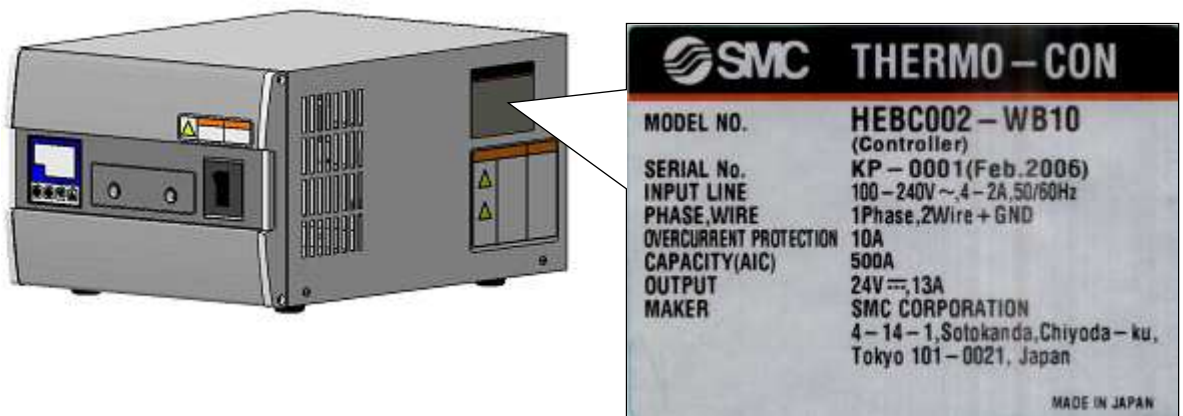

Fig. 1-4 Controller

## 1.4 Safety Measures

### 1.4.1 Precautions

This product is designed with consideration for safety. However, misuse may result in electrical shock or other accidents.

Be sure to keep the following instructions in mind to prevent accidents.

#### **WARNING**



- Only people that have sufficient knowledge and experience with electrical appliances should handle this product.

#### **WARNING**



- Be sure that you understand how the chemical fluids use in this product affect the human body. Follow the MSDS when handling chemical fluids.

#### **WARNING**



- Read the precautions described in this manual carefully and keep them strictly.

#### **WARNING**



- Stop operation immediately after any abnormal occurrence. If an abnormality (noise, odor, smoke, water leakage, etc.) occurs, stop this product (cutoff the power supply and stop the cooling water supply) and contact the sales distributor or branch for maintenance and repair.

Abnormal noise,  
odor, smoke or  
water leakage  
occurs;



- 1) Cutoff power supply
- 2) Stop water feed and supply
- 3) Request repair

#### **WARNING**



- Do not disassemble or retrofit this product. The internal parts of this product cannot be retrofitted by the user. Contact the sales distributor or branch for all repairs. The user must not perform any repairs. A product repaired by the user cannot be guaranteed and carries the danger of causing electrical shock and other accidents.

**CAUTION**



- **Margin of safe performance**  
Keep within the margin of safety in relation to cooling and heating capacity. Also, consider the safety margins of flow rate and drops in pressure because they are influenced by the piping conditions.

**CAUTION**



- **Restarting power supply**  
When restarting the power supply, wait 3 sec or more after the indications on the display and operating panel disappear.

### 1.4.2 Protective Equipment

**WARNING**



- **Wear protective equipment in order to maintain safety when installing and/or handling the product.**  
When handling chemicals for the product especially, note the contents of the MSDS and wear protective goggles, gloves, and a mask.

**WARNING**



- **Touching the recirculating fluid and internal face of the liquid tank may cause burns or frostbite depending on the temperature set for this product. Be sure to use heat (cold) resistant gloves when handling this product.**



Protective goggles



Mask



Gloves



Safety shoes

Fig. Fig. 1-5 Protective equipment

### 1.4.3 Long-term Storage

<b>⚠ CAUTION</b>	
	<ul style="list-style-type: none"> <li>● Cutoff the power supply and completely remove the recirculating fluid from the liquid tank to prevent residual fluid from exiting through the recirculating pump. Also, do not allow foreign matter to enter the inside of the tank. Drain cooling water from the liquid tank.</li> </ul>

<b>⚠ CAUTION</b>	
	<ul style="list-style-type: none"> <li>● Do not keep the recirculating pump idling. The use of an air gun or similar equipment for removing recirculating fluid from the liquid tank causes the recirculating pump to idle and may cause damage.</li> </ul>

### 1.4.4 Disposing of Product

When disposing of this product, be sure to use an industrial waste processing vendor that conforms to the “Law concerning disposal of waste and cleaning” and the “Ordinance defined by each municipal corporation”. Dispose of the recirculating fluid in the manner described in the MSDS.

## 1.5 Interlock List

Table 1-1 Interlock List

No.	Content	Installation part	Status of product after interlock works
1	Thermostat Circuit opened when 90°C or more is reached.	At recirculating fluid side.	Control is stopped. TROUBLE LED (red) lights up.
2	Thermostat Circuit opened when 60°C or more is reached.	At cooling water side.	



# Chapter 2 Description and Function of Each Part

## 2.1 Liquid Tank/Controller

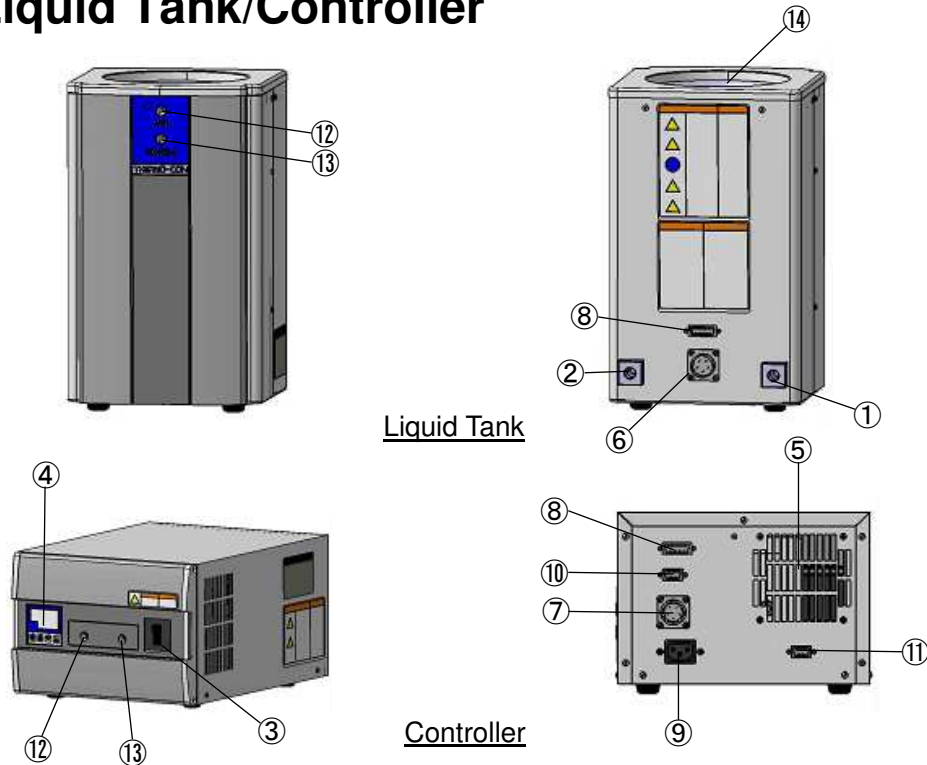

Fig. 2-1 Thermo Electric Bath

Table 2-1 Thermo Electric Bath

No.	Description	Function
①	Cooling water inlet	The connection size of the cooling water inlet port is Rc1/4. The ports for the inlet and outlet are specified individually, but reversing the connection does not affect performance.
②	Cooling water outlet	Cooling water outlet port. It is the same size as the cooling water inlet port.
③	Circuit protector (Power switch)	Turns the power supply of the product on and off.
④	Operation and display panel	Various displays are shown and settings are input.
⑤	Cooling fan	Fan for cooling the internal electric components of the controller. Air is sucked in from the controller side and discharged through the back via this fan.
⑥	DC connector (DC)	Connector for the DC input. A DC cable is connected here.
⑦	DC connector (DC OUTPUT)	Connector for the DC output. A DC cable is connected here.
⑧	Signal connector (SIGNAL)	Connector for the temperature sensor signal and thermostat. A signal cable is connected here.
⑨	Power supply connector (AC)	Connector for the single phase AC (AC100 to 240V) power supply. A power supply cable is connected here.
⑩	Alarm output connector (ALARM)	Connector for the upper/lower limit deviation alarm and output cutoff alarm. A relay contact is opened when these alarms are output.

<b>No.</b>	<b>Description</b>	<b>Function</b>
⑪	Communication connector (COMMUNICATION)	Connector for communication with RS-485 or RS-232C.
⑫	RUN LED (Green)	Lights up while the product is running.
⑬	TROUBLE LED (Red)	Lights up when an abnormality occurs. For details, refer to page 5-21 "5.5.1 Content of Alarms", Table 5-3.
⑭	Tank	A tank with an inside diameter of $\phi$ 130 and a maximum fluid level of 188mm.

# Chapter 3 Composition and Function of Product

## 3.1 Composition

The Thermo Electric Bath consists of a Liquid Tank with built-in thermo-modules and a Controller with a built-in DC power supply to actuate the thermo-modules. The Liquid Tank and Controller are connected to each other by a DC cable and signal cable.

### 3.1.1 Outline

The Controller is used to control the temperature of the recirculating fluid flowing in the product. A temperature sensor placed inside of the liquid tank (platinum resistive temperature detecting sensor) sends a signal to the Controller and the Controller adjusts the direction and time of the built-in DC power supply output depending on the deviation of the signal from the set temperature, which results in precise control of the recirculating fluid temperature.

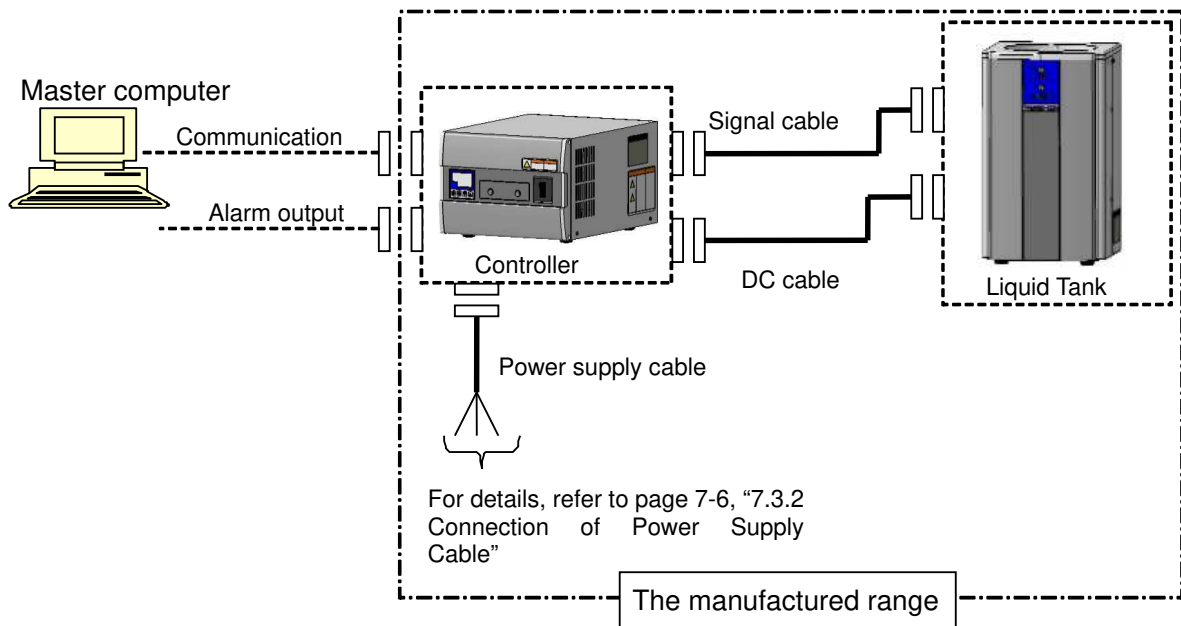

Fig. 3-1 Outline

Table 3-1 Outline

Description	Summary
Liquid Tank	A tank whose double layer construction can reduce temperature distribution and has a built-in recirculating pump.
Controller	A DC power supply is built into this Controller. The power supply is AC100V to 240V, single phase, 50/60Hz and approx 4 to 2A.
DC cable	A cable for sending DC power from the Controller to the Liquid Tank.
Signal cable	A cable for sending and receiving signals between the Controller and Liquid Tank.
Power supply cable	A cable for supplying AC100V to 240V.

**⚠ WARNING**



- The cables attached to this product are designed specifically for this Thermo Electric Bath. Do not use them for other purposes. Also, never use other cables for this product.

### 3.1.2 Operating Principles

#### ■ Structure and Principle of Thermo-module

A thermo-module (Thermoelectric device) is a unit consisting of multiple semiconductor elements. It can perform cooling and heating freely with direct current, be placed in line for electric purposes and be placed in parallel for thermal purposes.

When two different conductors or semiconductors are connected and direct current is applied to them, suction or the generation of heat other than Joule heat is seen at the connected part; this is called the Peltier effect. If P-type and N-type semiconductors are connected with a metal, as shown in the figure below, and current is applied, the suction of heat is seen at the connected part. The other connected part will have a high temperature and will generate heat. This effect is reversible; suction and the generation of heat occurs in the opposite direction when the current direction is reversed. Therefore, if the heat at the high temperature side is handled efficiently, a continuous heat pumping from low temperature side to high temperature side can be realized. With this principle, the N-type semiconductor has an electron current flowing in the opposite direction to the current and the P-type semiconductor has a "hole" current flowing in the same direction as the current. These electron and "hole" current move heat.

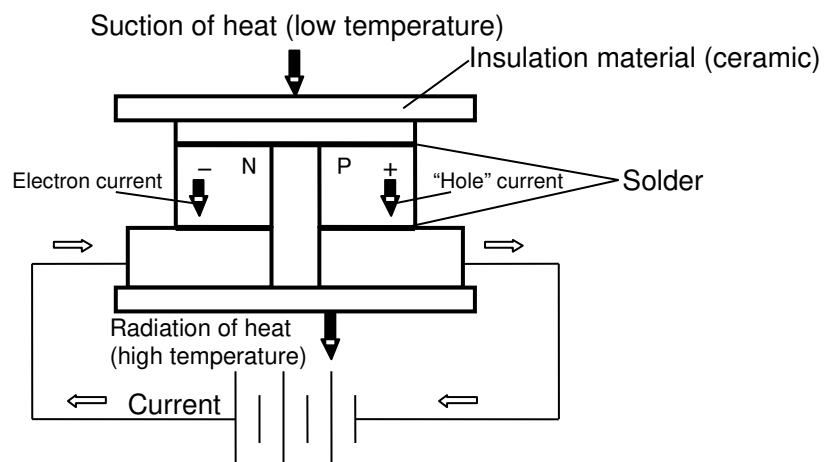

Fig. 3-2 Construction and principle of thermo-module

### ■ Operation Principle

In this product, many thermo-modules are placed in line between heat exchangers. At one side, cooling water is supplied and at the other side, a tank storing the recirculating fluid is mounted. Both ends of the thermo-modules that are connected electrically in line have a DC power supply whose current is regulated by a Controller. A temperature sensor placed at the inside of the liquid tank (platinum resistive temperature detecting sensor) sends a signal to the Controller and the Controller adjusts the direction and time of the built-in DC power supply output depending on the deviation of the signal from the set temperature, which results in precise control of the recirculating fluid temperature.

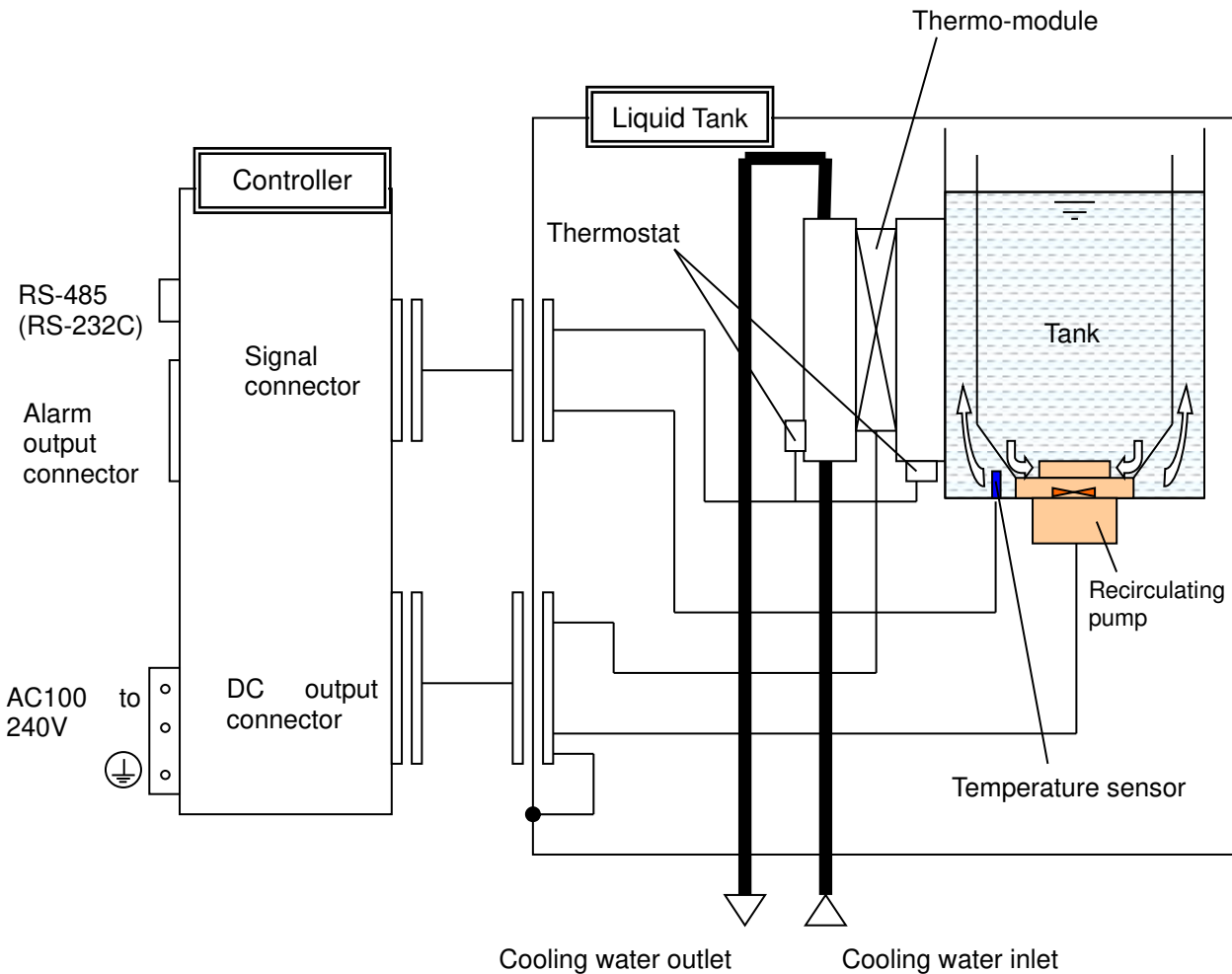

Fig. 3-3 Operation principle

## 3.2 Function

### 3.2.1 Auto Tuning Function

This function automatically adjusts the PID values (proportional band, integrating time, and derivative time) necessary for control. To learn how to operate this function, refer to page 5-10, "5.4.7 Details of Initial Setting Mode".

#### [Tips]

Appropriate PID values are input at the time of shipment from the factory. If the temperature deviation is found at these values on a regular basis, try to perform auto tuning. The Controller will calculate and set PID values automatically. Auto tuning may require a significant amount of time to complete, depending on the operating conditions.

If auto tuning fails, return to the values set at the time of shipment from the factory (refer to page 5-12, "5.4.9 Details of Control Setting Mode") or input the optimum values.

### 3.2.2 Temperature Upper / Lower Deviation Limit Alarm Function (at shipment)

This function generates an alarm when the measured temperature deviates from the set temperature by an amount outside of that defined as the upper or lower limit deviation. In that case, the **AL1** LED of the Controller lights up and the alarm is generated via relay contact to a pin for the temperature upper/lower deviation alarm of the alarm output connector. After the measured temperature returns to within the upper or lower deviation, the alarm will be reset automatically. In its initial setting, the alarm comes on immediately after the power supply is turned on when the temperature at that time deviates from the set temperature by an amount outside of the upper or lower deviation limit. It is possible to change this setting so that the alarm will not come on during warm-up to a temperature within the upper and lower deviation limit after the power supply is turned on. (Refer to page 5-15, "5.4.11 Details of EV Output Setting Mode")

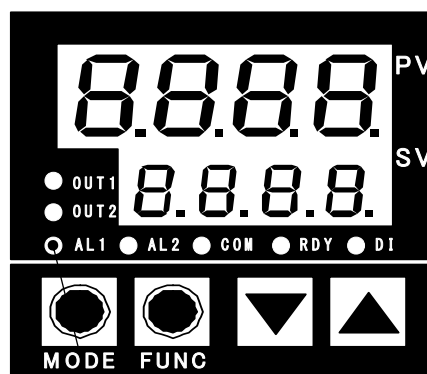

This LED lights up when the temperature deviation alarm occurs.

Table 3-2 Relay contact for temperature deviation alarm

<b>Item</b>	<b>Specification</b>
Output type	Relay contact output: Opened when an alarm occurs.
Contact rating	125VAC,0.4A/30VDC,2A (resistive load) 125VAC, 0.2A/30VDC,1A (inductive load)
Minimum load	5VAC,10mA / 5VDC,10mA
Mechanical life	5 million cycles or more
Electrical life	0.2 million cycles or more



### 3.2.3 Offset Function

This function adjusts the measurement range of the temperature sensor from -1.0 to 1.0°C. The temperature sensor can be calibrated by inputting the difference (calibration value) between the temperatures of a standard thermometer and the temperature sensor.

#### [Tips]

The Controller has already been given the calibration value of 25°C independently. This input value is described in the Inspection Record.

### 3.2.4 Set Value Memory (EEPROM back-up)

This function memorizes all set values input via the operation and display panel to nonvolatile memory EEPROM as back-up. Even if the power supply is turned off, the settings remain and do not need to be reset when the power supply is restarted.

#### CAUTION



- Any set value input via the communication function is not stored. If they need to be stored, use a storage request message. (Refer to page 7-9, “7.4.3 Type of Message”.)

#### CAUTION



- The writing limit is approx. 0.1 million times. If the setting is performed via the communication function, pay attention to how many times the writing has been done.

### 3.2.5 Output cutoff Alarm Function

This function cuts off output to the thermo-module (stops control) and generates an alarm when a serious abnormality occurs. When the alarm occurs, the TROUBLE LED lights up and the alarm is generated via relay contact to the pin for the output cutoff alarm of the alarm output connector. The specifications of the relay contact are shown in Table 3-3. This alarm cannot be reset unless the power supply is turned off once and restarted. Problems that may cause this alarm include the following:

- ① Overheating of Liquid Tank (Thermostat starts operating.)
- ② Lowering of Controller output voltage
- ③ Stopping of Controller fan rotation

Table 3-3 Relay contact for output cutoff alarm

Item	Specification
Output type	Relay contact output: Opened when an alarm occurs.
Contact rating	125VAC,0.4A/30VDC,2A (resistive load) 125VAC, 0.2A/30VDC,1A (inductive load)
Minimum load	5VAC,10mA / 5VDC,10mA
Mechanical life	5 million cycles or more
Electrical life	0.2 million cycles or more

### 3.2.6 Alarm Indication on Operation and Display Panel

Alarms indicated on the operation and display panel are as follows. There is no output generated to the alarm output connector. If this type of alarm occurs, be sure to turn off and restart the power supply once after the trouble causing the alarm is eliminated.

Table 3-4 Indication of alarms on operation and display panel

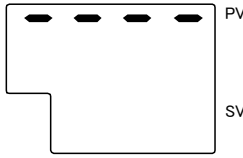
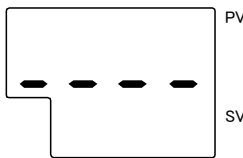
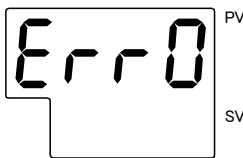
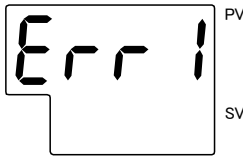
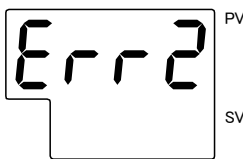
Indicator	Content of alarm
	Shown when a temperature sensor is opened (including disconnection of the signal cable).
	Shown when a temperature sensor is short circuited.
	Shown when the Controller has a memory error.
	Shown when the Controller has an A/D conversion error.
	<p>The auto tuning has failed.</p> <p>This alarm also occurs when auto tuning is not finished after approx. 3 hours. The key-in operation can restart control with PID values before auto tuning.</p>

### 3.2.7 Communication Function

- HEBC002-WA10

This product has a communication function conforming to communication protocol RS-485. The transmission cable length, i.e., transmittable distance, is 500m. RS-485 enables one master computer to set and monitor operation conditions of up to 31 Thermo Electric Baths.

- HEBC002-WB10

This product has a communication function conforming to communication protocol RS-232C. The transmittable distance is 15m. RS-232C enables one master computer to set and monitor the operating conditions of only one Thermo Electric Bath.

The content communicated by this product is as follows.

- 1) Setting and reading of target temperature
- 2) Reading of measured temperature
- 3) Setting and reading of offset value
- 4) Storage of set value (Any set value input via the communication function is not stored. If they need to be stored, use a storage request message.)



## Chapter 4 Set-up

### 4.1 Set-up, Transport and Transfer

#### CAUTION



- For set-up, transport and transfer of this product, continue to observe safety precautions, especially those for the human body.

#### CAUTION



- Set-up, transfer and maintenance, including dangerous work, must only be performed by people who have sufficient knowledge and experience with this product.

#### 4.1.1 Transport and Transfer

- Avoid strong vibrations and impacts

This product is precise equipment and must not be subject to strong vibration and impact during transport and transfer.

#### CAUTION



- Be sure to transport using a packaging box specific to the Thermo Electric Bath.

#### 4.1.2 Environment

#### CAUTION



- Do not use or store this product in the following environments, where the product may not work normally and may be damaged.

- Environments containing splashing water, salt water, oil, or various chemicals (including chemical mists).
- Environments containing particles and dust.
- Environments containing corrosive gas, solvents and flammable gas.
- Environments containing direct sunlight and radiant heat.
- Environments having ambient temperatures over the following range:

Operation	10 to 35°C
Storage	0 to 50°C (with no recirculating fluid and with cooling water in the liquid tank and piping).

- Environments having ambient humidity over the following range:
  - Operation 35 to 80%
  - Storage 35 to 85%
- Environments with sharp temperature changes.
- Environments generating strong magnetic noise (having a strong electric or magnetic field that generates surges.)
- Environments generating electrical static discharge and conditions in which static electricity is applied to this product.
- Environments generating strong high frequency radiation (including radio frequency appliances such as mobile phones and tranceivers).
- Environments generating strong vibrations and impacts.
- Environments that may be damaged by lightning.
- Environments in which forces or gravity may deform the body of the product.
- Locating the cables of the product near the power lines of other machines.
- Conditions in which insufficient grounding for the power supply is provided
- Conditions that cause dew condensation (this may occur on the surface of the piping when the cooling water temperature is low).
- Environments containing harmful gases such as silicone.
- Places not allowing a space of 50mm or more at the air inlet of the Controller and thus causing the sucking of exhausted heat from the air inlet.
- Places preventing the horizontal set-up of the product.

### 4.1.3 Set-up in Clean Room

This product uses a fan and generates dust. When it is set up and operated in a clean room, take appropriate preliminary measures for dust.

<b>CAUTION</b>	
	<ul style="list-style-type: none"><li>● <b>This product can be used in environments with contamination degree 1 or 2.</b></li></ul>

## 4.2 Piping

- Bending of the tube  
Confirm that the tube is not bent to the point where it is kinked and may prevent fluid flow.

### 4.2.1 Preparation of Cooling Water

- Connect fittings to the ports (Rc1/4) marked “IN” and “OUT” on the Liquid Tank to provide piping for the inlet and outlet of cooling water, respectively.
- When connecting fittings to the ports, prevent leakage with seal tape or other methods. Also, hold the fitting mounting part with a spanner to avoid applying directly to the fitting mounting part of the product the force created by connecting the fittings. The recommended tightening torque is 12 to 14Nm.

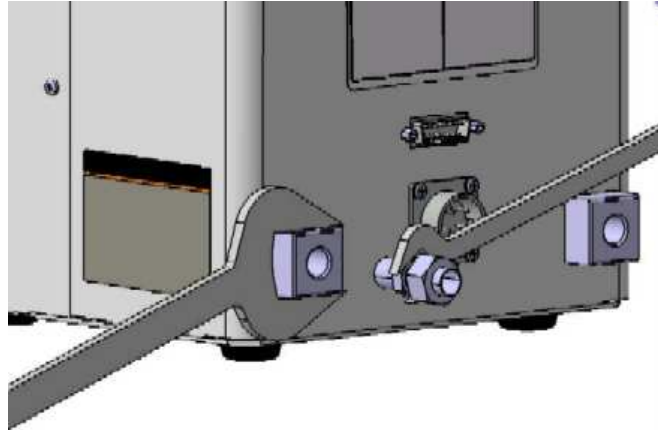

- The appropriate flow rate range is from 3 to 5L/min. If a higher flow rate is supplied, the cooling and heating capacity will be slightly affected, but a flow rate of lower than 3L/min will impair the cooling and heating capacity significantly.

**⚠ WARNING**



- Be sure to avoid operating the product without cooling water or with cooling water at extremely low flow rates. At low flow rates, the cooling water temperature can reach approx. 90°C and soften and rupture resin tubes, which can be used for connection. Therefore, naturally cool down the product and supply the cooling water at an adequate rate.

**⚠ WARNING**



- Supply the cooling water at 8L/min or less in order to prevent the radiating system from being damaged.

**⚠ CAUTION**



- Use fresh water such as tap water for the cooling water. If cooling water is circulated, control the quality of the cooling water to prevent corrosion of the wetted material. For quality standards for the cooling water, refer to page 4-5, “4.2.2.Quality of Cooling Water [Wetted material] SUS303, SUS304, FEP, A6063(anodized)

**⚠ CAUTION**



- Keep the cooling water temperature between 10 and 35°C. (No dew condensation)  
Note that the cooling and heating capacity is changed depending on temperature. Also, when low-temperature cooling water is supplied, dew condensation may occur, damaging the internal electric equipment. Keep the temperature above the atmospheric pressure dew point. Alternatively, the user may take measures to prevent dew condensation, such as an N<sub>2</sub> purge. To obtain the dew point, refer to page 7-22 “7.6 Calculation of Dew Point Temperature (from psychrometric chart).

**⚠ CAUTION**



- The maximum operating pressure is 0.5MPa. Keep the pressure as low as possible to prevent water hammer.

**CAUTION**



- Eliminate all conditions which could cause the cooling water or fluid leakage.



## 4.2.2 Quality of Cooling Water

<b>⚠ CAUTION</b>	
	<ul style="list-style-type: none"> <li>Use fresh water (tap water) that satisfies the quality standards shown in Table 4-1 for cooling water. If other liquids are used, the product could break and leak fluid, resulting in electrical shock or earth leakage.</li> </ul>

Table 4-1 Quality standard for fresh water (tap water)

	Item	Standard value
Quality item	pH (25°C)	6.5 to 8.2
	Electric conductivity (25°C) ( $\mu$ s/cm)	100 to 800
	Chloride ion (mgCl <sup>-</sup> /L)	200 or less
	Sulphate ion (mgSO <sub>4</sub> <sup>2-</sup> /L)	200 or less
	Acid consumption (pH4.8) (mgCaCO <sub>3</sub> /L)	100 or less
	Total hardness (mgCaCO <sub>3</sub> /L)	200 or less
	Calcium hardness (mgCaCO <sub>3</sub> /L)	150 or less
	Ion silica (mgSiO <sub>2</sub> /L)	50 or less
	Iron (mgFe/L)	1.0 or less
	Copper (mgCu/L)	0.3 or less
	Sulphide ion (mgS <sup>2-</sup> /L)	None detected
	Ammonium ion (mgNH <sub>4</sub> <sup>+</sup> /L)	1.0 or less
	Residual chlorine (mgCl/L)	0.3 or less
	Free carbon (mgCO <sub>2</sub> /L)	4.0 or less
Filtration ( $\mu$ m)	5 or less	

### 4.2.3 Preparation of Recirculating Fluid

- Supply recirculating fluid slowly by using a funnel or a manual pump.
- The recirculating fluid has effective range of levels. Check that it reaches that range under operating conditions.
- Confirm that the recirculating fluid reaches the level marked “LOW” at the inner face of the liquid tank. “HIGH” is not marked but consider to be at the upper end of the outside tank. Keep within this range. (Refer to page 7-1, Fig. 7-2 Internal dimensions of Liquid Tank”.)

**⚠ WARNING**



- Do not operate without recirculating fluid, or the product may idle and break.

**⚠ WARNING**



- Do not use in such a manner that the recirculating fluid overflows or splashes during operation. This could cause the machine to break.

**⚠ WARNING**



- If water is used for the recirculating fluid, keep the temperature at 5°C or more (considering the offset value). Use at a lower temperature could break the circulating pump.

**⚠ CAUTION**



- Check the fluid level at least once a day. The recirculating fluid may evaporate. The product is unable to maintain performance at a significantly lower fluid level and this could cause breakage of the circulating pump. Maintain the appropriate level at all times.

**⚠ CAUTION**



- Check at least once a day for the presence of foreign matter in the recirculating fluid. If foreign matter enters the circulating pump, the pump could break.

**⚠ CAUTION**



- Use fresh water (tap water) that satisfies the quality standards shown in Table 4-1 for cooling water. If other liquids are used, the product could break and leak fluid, resulting in electrical shock or earth leakage.

**⚠ CAUTION**



- When the set temperature is increased from a low value to an ordinary value, some kinds of the recirculating fluid can swell, increase and overflow, which can not only break the thermo electric bath and other equipment, but also cause a serious accident. Take a measure to prevent this situation in advance by decreasing the amount of the recirculating fluid, etc.

**⚠ CAUTION**



- Never perform operation under conditions that may create cavitation and lower the fluid level, which could allow the air to enter the fluid and break the pump.

**⚠ DANGER**



- To avoid the danger of electrical shock, do not perform wiring repairs or operate the product with wet hands.

#### 4.2.4 Draining the Recirculating Fluid

- Stop the product (cut the power supply and cooling water) and remove the connected cables and piping before draining.
- This product does not contain a draining function and the recirculating fluid thus needs to be drained with a manual pump.
- Draining from the bottom of the tank or inside of the recirculating pump, which cannot be handled with a manual pump, can be performed by turning the tank so that the slits inside the tank are facing down and inclining the tank gradually.

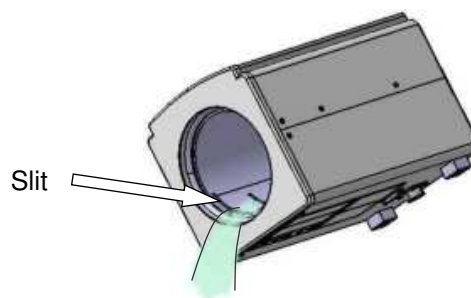

**⚠ WARNING**



Inclination of the tank for draining must be performed by two or more workers to prevent possible injury and/or damage to the product due to the tank being dropped. Also, because the recirculating fluid may spill from the tank, prepare a pan to receive it or work in a location where fluid spills can drain. Additionally, wear protective equipment  
Tipping of the tank for draining must be performed by two or more

**⚠ WARNING**



Stop the product (cut the power supply and cooling water) and remove the connected cables and piping before draining. Draining without stopping the product might cause the power supply to turn on unexpectedly or the piping to disconnect, which would result in a jet of water.

**⚠ WARNING**



**Take care not to splash the recirculating fluid on the inside of the product and the connectors when draining. If water splashes on the connector or the product body, wipe them off and allow them to dry sufficiently to prevent electrical shock, a short circuit, or ignition.**

## 4.3 Wiring

### 4.3.1 Earth Leakage

Prepare the power supply side for a power supply cable separately.  
Connect the power supply cable according to page 7-6, "7.3.2 Connection of Power Supply Cable".

#### **WARNING**



- This product must be supplied with power through a branch protective circuit and earth leakage breaker rated at 15A or less.

#### **WARNING**



- Be sure to use a round crimping terminal suitable for the specifications of the power supply cable (AWG14) and a terminal block to connect them and supply power through the earth leakage breaker.

#### **WARNING**



- Terminate the power supply cable in a manner suitable to the specifications of the connected equipment. Do not use crimping after soldering.

### 4.3.2 Power Supply

Confirm that the power supply at your workplace has sufficient capacity and a voltage within that specified. (Refer to the electrical specifications of the power supply.) This product is provided with a power supply cable. Connect the power supply cable according to the instructions on page 7-6, "7.3.2 Connection of Power Supply Cable".

Electrical specifications of power supply

AC100-240V 50/60Hz 4 to 2A  
Single phase: 2-wire type + GND (PE) line

#### **WARNING**



- The cables attached to this product are designed specifically for the Thermo Electric Bath. Do not use them for other purposes. Also, never use other cables for this product.

### 4.3.3 Grounding

**⚠ WARNING**



- The ground insulation class of this product is class I. Be sure to provide protective ground, which must be class D for Japan (ground resistance of 100ohm or less). Grounding can be provided via the PE line of the power supply cable. For details of the power supply cable, refer to page 7-6, “7.3.2 Connection of Power Supply Cable”. Do not use the same ground being used by equipment that generates strong electrical magnetic noise or high frequencies.

**⚠ WARNING**



- If a fluid with low conductivity is used as the recirculating fluid, the fluid will generate static electricity due to friction. If a charge is built up in the temperature control target immersed in the product, it may be discharged in the user’s machine. Therefore, provide ground from the temperature control target.

### 4.3.4 Avoidence of Parallel Wiring

Avoid connecting an attached signal cable or a signal line (such as those used for communications and alarms) in the same route as or in parallel to a power line or high voltage line.

### 4.3.5 Incorrect Wiring

Incorrect wiring may lead to product damage or malfunction. Ensure that there is no incorrect wiring.

**⚠ WARNING**



- The cables attached to this product are designed specifically for the Thermo Electric Bath. Do not use them for other purposes. Also, never use other cables for this product.

### 4.3.6 Removal of Cables

The worker must turn off the power supply before handling the cables.

### 4.3.7 Connection of Various Types of Connectors and Power Supply Plugs

- Ensure that the power supply of the product is turned off before connecting the easy-type connector and power supply plug.
- If communications lines are used, connect the product and master computer with a shielded cable to reduce the effects of noise.
- The insulation class of this product is class I. Connect the power supply cable to a single phase power supply and ground. Be careful not to make a mistake such as connecting the power supply to ground. Connect the power supply cable according to the instructions on page 7-6, "7.3.2 Connection of Power Supply Cable". (The power supply cable is attached to the product.) Frame ground is used as the PE ground of the power supply cable, and so needs a more secure grounding (class D).
- Connect the power supply cable to a branch protective circuit and earth leakage breaker rated at 15A or less.

#### **WARNING**



- **Connect the power supply plug to the Controller. The connector is the inserted-type. Ensure that it is firmly inserted into the end.**

## 4.4 Installation

#### **CAUTION**



- **The mounting orientation of this product is horizontal. Place the product in a flat area which can handle its weight and take measures to prevent the tipping of the product. If installed improperly, the product might leak water or topple, resulting in injury.**





# Chapter 5 Operation

## 5.1 Start of Operation

1. Confirm that the recirculating fluid has reached the “LOW” level of the tank and supply cooling water to the Liquid Tank.

---

2. Confirm that there is no incorrect wiring of the connected cables and the power supply cable and turn on the power supply of the Controller.

---

3. The Controller will show the current recirculating fluid temperature for approx. 6 sec. after the power supply is turned on.
  - If an alarm occurs after the power supply is turned on, check the indicated content of the alarm and turn off the power supply to find the cause so that appropriate measures can be taken.

---

4. The following alarms might come on when operation starts. For details, refer to Table 5-3 “Content of Alarms”.

● Alarm indication on the display

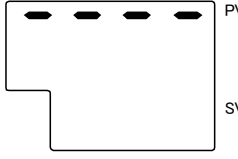
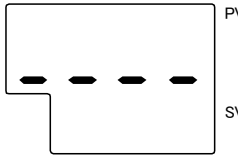
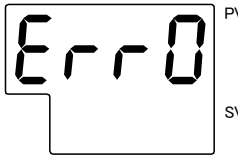
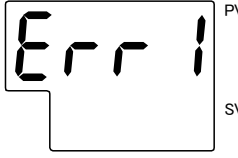
Indicator	Content
	Shown when a temperature sensor is opened (including disconnection of the signal cable).
	Shown when a temperature sensor is short circuited.
	Shown when the Controller has a memory error.
	Shown when the Controller has an A/D conversion error.

- Content of the alarm when the TROUBLE LED lights up
  - When the Controller output voltage decreases.
  - When the number of Controller fan revolutions decreases.
  - When the thermostat of the Liquid Tank is operating.

## 5.2 Setting of Values

When the product has been found to start operating normally set the values such as temperature.

1. Perform offset adjustment if necessary, referring to page 5-7, “5.4.4 Details of Operation Mode”.
2. Set each value such as set temperature and upper and lower temperature limit.
  - Set required values, referring to page 5-4, “5.4 Operation of Controller”.

With this action, all preparation is complete. When the product is returned to the operation mode, it will operate with these set conditions.

- 
3. Once values are set on the operation display panel, they will not be erased even when the power supply is turned off.

## 5.3 Cautions for Operation Control

- Wait at least 30 min. after the power supply is turned on before operating to allow the product to warm up.
- If an alarm comes on during operation, refer to page 5-21, “5.5.1 Content of Alarms”, for the remedy.
- When low-temperature cooling water is supplied, dew condensation may occur, damaging the internal electric equipment. Keep the cooling water temperature over the atmospheric pressure dew point. For dew point temperature, refer to page 7-22, “7.6 Calculation of Dew Point Temperature (from psychrometric chart)”.

### **WARNING**



Touching the recirculating fluid or the internal face of the liquid tank may cause burns or frostbite, depending on the set temperature of this product. Be sure to use heat (cold) resistant gloves when handling this product



### **CAUTION**



When an antifreeze liquid (GALDEN<sup>®</sup>, etc.) is used as the recirculating fluid, wipe off the moisture on the surface of the liquid to prevent impairment of the product performance and damage to the recirculating pump.

 **CAUTION**



- Check the fluid level at least once a day. The recirculating fluid may evaporate. A significant lowering of the level will cause it to be unable to maintain performance and could break the circulating pump. Maintain the appropriate level at all times.

 **CAUTION**



- Do not allow foreign matter to enter the recirculating fluid. The foreign matter could enter the inside of the recirculating pump and damage it.

## 5.4 Operation of Controller

### 5.4.1 Details of Operation and Display Panel

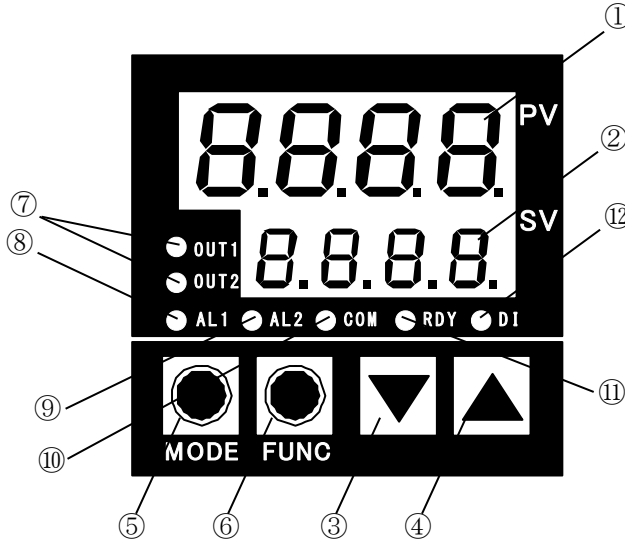

Fig. 5-1 Details of operation and display panel

Table 5-1 Details of operation and display panel

No.	Description	Detail
①	Value indicator LED1	Displays characters indicating temp. control or setting content.
②	Value indicator LED2	Displays set temperature or each selected input value.
③	[▼] key (DOWN key)	Decreases set data.
④	[▲] key (UP key)	Increases set data.
⑤	[MODE] key	Changes the screen.
⑥	[FUNC] key	Implements the function selected by the function setting. Set as a digital transferring key at the initial setting. If this setting is changed, the RUN/READY key can be used as an auto tuning key.
⑦	Output LED	OUT1: Lights up during heating. OUT2: Lights up during cooling.
⑧	AL1 LED	Lights up when temperature upper/lower deviation limit occurs. (Initial condition)
⑨	AL2 LED	Unused
⑩	Communication LED	Flashes during communication. Normally, it remains on.
⑪	RDY LED	Lights up when control is stopped. Refer to page 5-12, "5.4.9 Details of Control Setting Mode".
⑫	DI LED	Unused

## 5.4.2 Setting of Data

The Controller has two modes, the operation mode and the setting mode. Each mode has the following content.

- Operation mode: Normally used.
- Setting mode: Used to set control values manually

### ■ Selection of mode

- Operation mode: Turn on power supply
- Setting mode: Press and hold [MODE]key for 2 sec.

### ■ Setting of functions and data in each mode

1. Press [MODE] key in each mode to select the required function.
2. Increase or decrease data with the [▲] or [▼] key.
  - Each press of the [▲] key increases the data by one count.
  - Each press of the [▼] key decreases the data by one count.
  - Holding the [▲] or [▼] key accelerates the increase or decrease.

### CAUTION



- Be sure to operate the operation and display panel by hand. Using tools such as a screwdriver, pen, or pencil may damage the panel.

### 5.4.3 Selection of Operation Mode

When the power supply is turned on, the product is in operation mode. The target temperature is shown as well as the current measured temperature. Each press of the [MODE] key changes the operation mode display as follows.

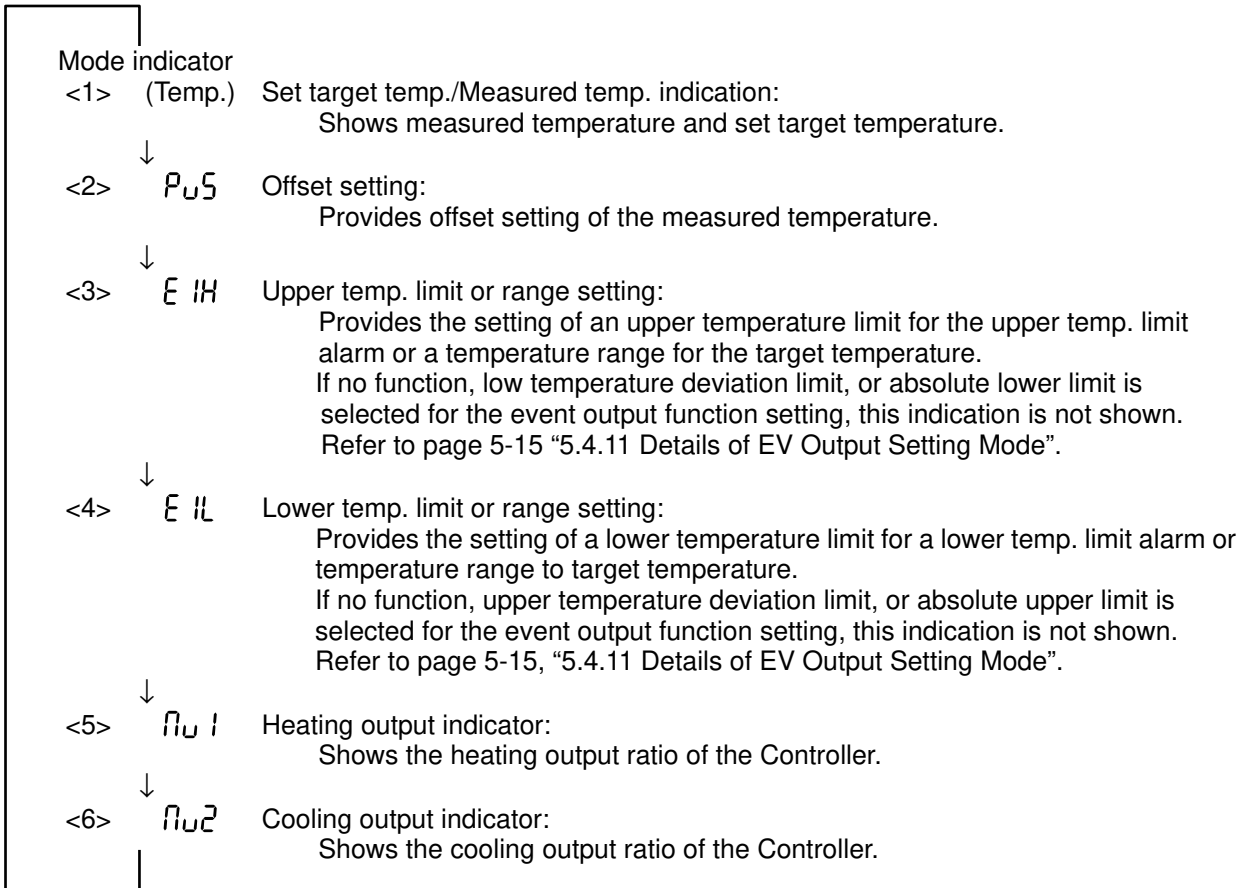

---

**[FUNC] key**

- Set as a digit transferring key for the initial setting. If this setting is changed, the RUN/READY key can be used as an auto tuning key.
-

### 5.4.4 Details of Operation Mode

<1> Setting of target temp. / Display of measured temp. / Mode indicator (temp. indicator)

Initial value: 25.0°C

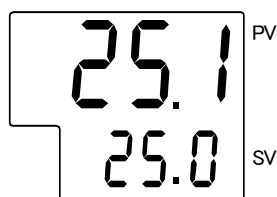

Setting range	-15.0 to 60.0°C
Indicator	PV: Display of measured temp. SV: Setting of target temp.
Function	Indicates measured temp. as PV. Sets target temp. as SV.

#### [Tips]

#### No key-in operation for 2min.

- If no key-in operation has been performed for 2min., the display will return automatically to the measured temperature for any setting status, including the initial setting mode, EV setting mode, and communication setting mode.

<2> Offset setting / Mode indicator: PUS

Initial value: Refer to the Inspection Record.

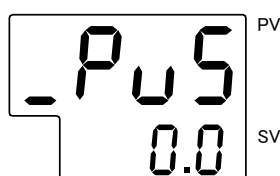

Setting range	Use within a range from -1.0 to 1.0°C.
Indicator	Offset setting Indicates that the offset setting mode is activating with "PUS".
Function	Sets the offset (compensating) value of the temperature sensor. For example, if 0.5 is set, the temperature is actually controlled to a value that is lower by 0.5°C.

<3> Upper temperature limit range setting / Mode indicator: EIH

Initial value: 1.5°C

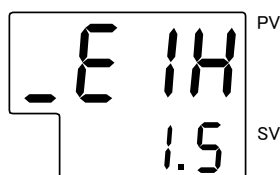

Setting range	Use within a range from -20.0 to 65.0°C.
Indicator	Upper temperature limit range setting Indicates that upper temperature limit range setting is activated with "EIH".
Function	Needs input of an upper temperature limit range or upper temperature limit for event output. For details of the event setting, refer to page 5-15, "5.4.11 Details of EV Output Setting Mode".

<4> Lower temperature limit range setting / Mode indicator: EIL

Initial value: 1.5°C

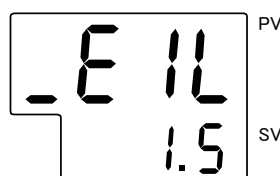

Setting range	Use within a range from -20.0 to 65.0°C.
indicator	Lower temperature limit range setting Indicates that lower temperature limit range setting is activated with "EIL".
Function	Needs input of a lower temperature limit range or lower temperature limit. For details of the event output, refer to page 5-15, "5.4.11 Details of EV Output Setting Mode".

Lights up when temp. upper / lower deviation limit alarm occurs.

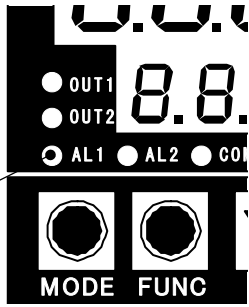

[Tips]

**Status when temp. upper/lower deviation limit alarm occurs (at the time of shipment from the factory)**

- AL1 LED lights up when temp. upper/lower deviation limit alarm occurs.
- Since control is continued, the LED switches off when the temperature returns to within the upper/lower limit temp. range.
- The alarm is activated when the temperature outside the range is first displayed.

<5> Heating output indicator / Mode indicator:  $\overset{\curvearrowright}{\cup} 1$



Indicator range	0.0 to 100.0%
Indicator	Heating output indicator Indicates the heating output displaying mode is activated, with " $\overset{\curvearrowright}{\cup} 1$ ".
Function	Indicates the heating output of the Controller.

<6> Cooling output indicator / Mode indicator:  $\overset{\curvearrowleft}{\cup} 2$



Indicator range	0.0 to 100.0%
Indicator	Cooling output indicator Indicates the cooling output displaying mode is activated with " $\overset{\curvearrowleft}{\cup} 2$ ".
Function	Indicates the cooling output of the Controller.



### 5.4.5 Selection of Setting Mode

Setting mode can be shown by pressing and holding the [MODE] key for approx. 2 sec.

Pressing the [MODE] key for approx. 2 sec again will return the setting mode to the normal operation mode.

Setting mode selection is indicated with "SEt" and the required setting mode can be selected by increasing or decreasing the indicated number with the [▲] or [▼] key.

Setting mode selection / Mode indicator: SEt

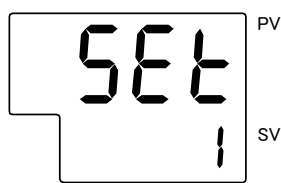

Setting range	1, 2, 3, 6
Indicator	Setting mode indicator Indicates that setting mode selection is activated with "SEt".
Function	Selects mode for each setting. 1: Initial setting mode 2: Control setting mode 3: EV output setting mode 6: Communication setting mode

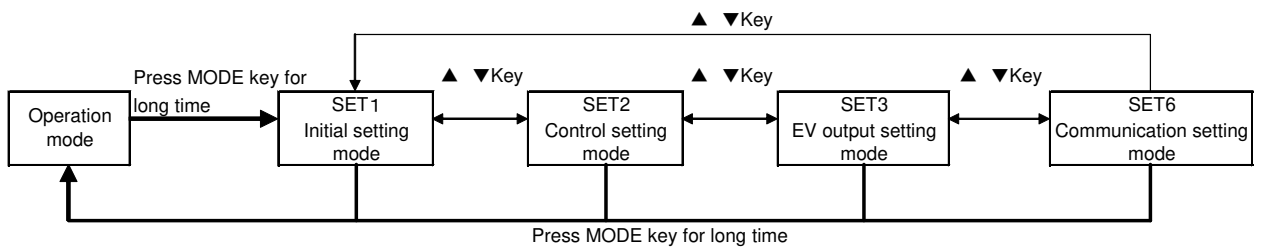

### 5.4.6 Selection of Initial Setting Mode

Inputting “1” in the setting mode “SEt” activates the initial setting mode. Each press of the [MODE] key changes the operating mode as follows.

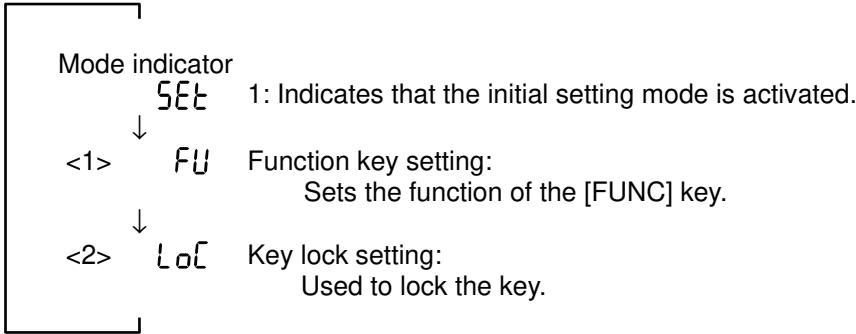

### 5.4.7 Details of Initial Setting Mode

<1> Function key setting: Mode indicator: FU  
 Initial value: 1

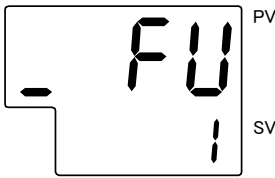

Setting range	0 to 4
Indicator	Function key setting Indicates that function key setting mode is activated with “FU”.
Function	Sets the function of the function key. 0: No function 1: Digit transferring key 2: RUN/READY key 3: AT key 4: No function

**[Tips]**

When “1” (digit transferring key) is selected in the function key setting, the digit can be moved.

**[Tips]**

When “2” (RUN/READY key) is selected in the function key setting, the product status becomes READY and control is stopped.

**[Tips]**

**Method of and status in auto tuning**

- Select “3” in the function key setting and press and hold the [MODE] key to return to the operation mode. Then, press the [FUNC] key to begin auto tuning.
- Normal indicator and AT indicator are shown alternately in auto tuning.
- If auto tuning stops midway, press the [FUNC] key again.
- The set value cannot be changed for auto tuning.
- Selecting “1” in the function key setting after auto tuning is completed is recommended.

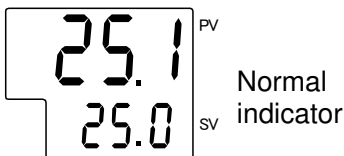
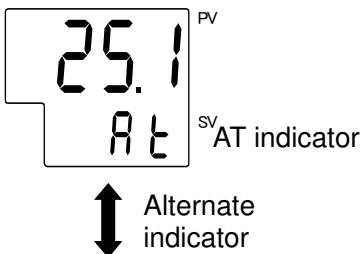

<2> Key lock setting / Mode indicator: **LoL**

Initial value: 0

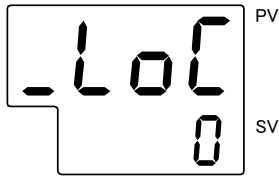

Setting range	0 to 3
Indicator	Key lock setting Indicates that the key lock setting mode is activated with "LoL".
Function	Sets the key lock function. 0: Lock off 1: Full lock (except for the key lock setting) 2: Lock for operation mode 3: Lock for other mode than operation mode

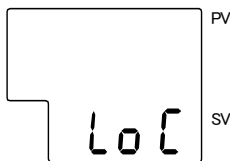

**[Tips]**

**Indicator for unavailable change**

If a change in a key-locked parameter is attempted, the indicator shown on the left appears to show that change is not available. The indicator continues to be displayed while the key is pressed.

### 5.4.8 Selection of Control Setting Mode

Inputting “2” in the setting mode ” *SEt* ” activates the control setting mode. Each press of the [MODE] key changes the operating mode as follows.

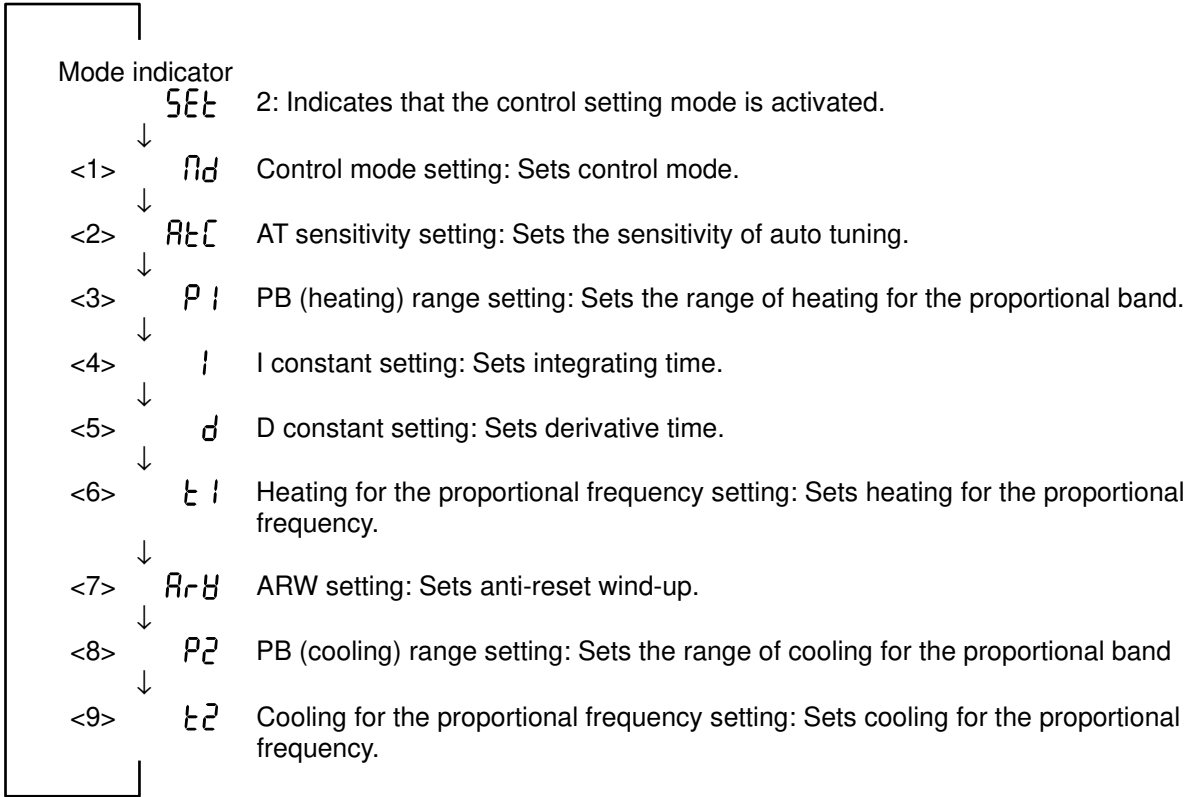

### 5.4.9 Details of Control Setting Mode

<1> Control mode setting / Mode indicator: *nd*

Initial value: *rUn*

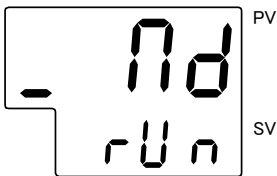

Setting range	Selected from <i>rUn</i> and <i>rdY</i> .
Indicator	Control mode setting Indicates that the control mode setting is activated with “ <i>nd</i> ”.
Function	Sets control mode. The set mode can be switched with the “ ▲ ” and “ ▼ ” keys. <ul style="list-style-type: none"> <li>• <i>rUn</i>: Starts controlling</li> <li>• <i>rdY</i>: Stops controlling</li> <li>• <i>nAn</i>: Not used</li> </ul>

**CAUTION**

- Do not select *nAn*.

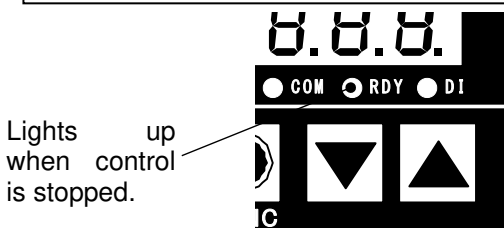

[Tips]

**Status when control is stopped**

When control is stopped, the RDY LED lights up.

[Tips]

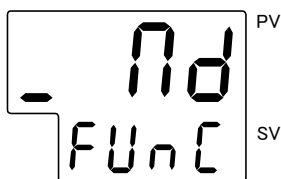

**Indicator for unavailable change**

If a change in a parameter in the control mode (refer to page 5-12, "5.4.9 Details of Control Setting Mode") is attempted when "2" (RUN/READY setting) is selected, the indicator as shown on the left appears to show that the change is not available. The indicator continues to be displayed while the key is pressed.

<2> AT sensitivity setting / Mode indicator: *ATC*

Initial value: 2.0°C

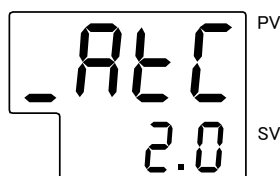

Setting range	0.0 to 999.9°C
Indicator	AT sensitivity setting Indicates that the AT sensitivity setting mode is activated with "ATC".
Function	Sets the sensitivity of auto tuning. ON/OFF control is implemented in auto tuning. If the measured value has a large deviation, auto tuning begins, which results in a PID constant calculation error. This function adjusts the sensitivity of auto tuning to prevent such an error.

<3> PB (heating) range setting / Mode indicator: *PI*

Initial value: 7.0%

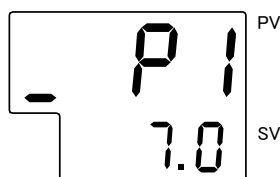

Setting range	0.1 to 200.0 %
Indicator	PB (heating) range setting Indicates that the PB range setting mode for heating is activated with "PI".
Function	Sets the range of the proportional band used for PID control. This range is a percentage of 75°C (=-15.0 to 60.0°C), which is the target temperature setting (SV) range.

<4> I constant setting / Mode indicator: *I*

Initial value: 250 sec.

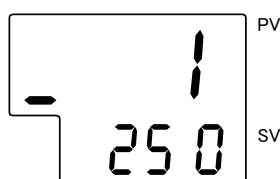

Setting range	0 to 3600 sec.
Indicator	I constant (integrating time) setting Indicates that the I constant setting mode is activated with "I".
Function	Sets the integrating time used for PID control. If "0" is set, integration is not implemented.

<5> D constant setting / Mode indicator: *d*

Initial value: 0 sec.

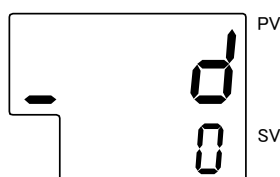

Setting range	0 to 3600 sec.
Indicator	D constant (derivative time) setting Indicates that the D constant setting mode is activated with "d".
Function	Sets the derivative time used for PID control. If "0" is set, differentiation is not implemented. (PI control)

<6> Heating proportional frequency setting / Mode indicator: *t1*  
Initial value: 2 sec.

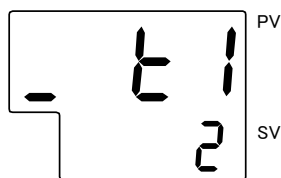

Setting range	1 to 120 sec.
Indicator	Heating for the proportional frequency setting Indicates that the heating for the proportional frequency setting mode is activated with "t1".
Function	Sets the heating for the proportional frequency. If the proportional frequency is set to 2 sec. and 70% control input is used, the output will be 1.4 sec. ON and 0.6 sec. OFF.

<7> ARW setting: Mode indicator: *ARW*  
Initial value: 100.0 %

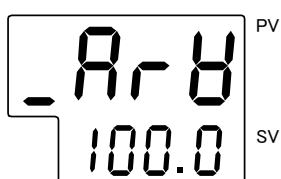

Setting range	0.0 to 100.0 %
Indicator	ARW setting Indicates that the ARW setting mode is activated with "ARW".
Function	Sets anti-reset wind-up. Reduces overshoot in PID control due to integrating operation. The integration operation is not performed above the set value. The set value must be higher than the output for stable control.

<8> PB (cooling) range setting: Mode indicator: *P2*  
Initial value: 0.50 times

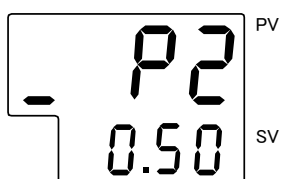

Setting range	0.0 to 10.00 times
Indicator	PB (cooling) range setting Indicates that the cooling PB range setting mode is activated with "P2".
Function	Sets multiples of the set PB for heating.

<9> Cooling proportional frequency setting: Mode indicator: *t2*  
Initial value: 2 sec.

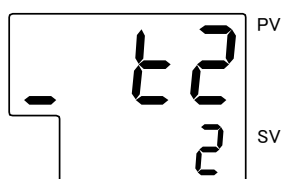

Setting range	1 to 120 sec.
Indicator	Cooling proportional frequency setting Indicates that the cooling proportional frequency setting is activated with "t2".
Function	Sets cooling proportional frequency. If the proportional frequency is set to 2 sec. and 70% control input is used, the output will be 1.4 sec. ON and 0.6 sec. OFF.

### 5.4.10 Selection of EV Output Setting Mode

Inputting “3” in the setting mode” **SEt**” activates the event output setting mode. Each press of the [MODE] key changes the operating mode as follows.

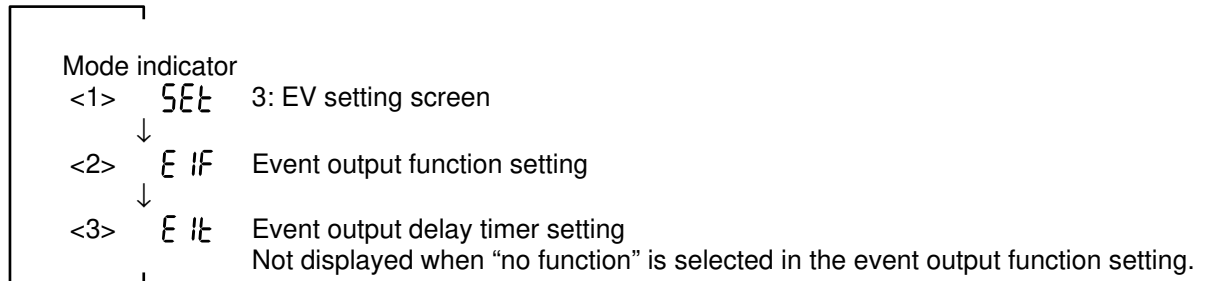

### 5.4.11 Details of EV Output Setting Mode

<1> Event output function setting: Mode indicator **E IF**  
 Initial value: 01

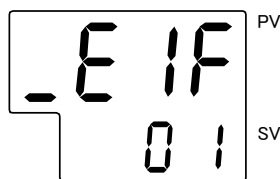

Setting range	1 <sup>st</sup> digit : 0 to 8, 2 <sup>nd</sup> digit : 0 to 3
Indication	Event output function setting: Indicates the event output function setting mode is activated with “E IF”.
Function	The number of digits is counted from the right side. 1 <sup>st</sup> digit : Event functions 0: No function 1: Upper/lower deviation limit 2: Upper deviation limit 3: Lower deviation limit 4: Upper/lower deviation limit range 5: Absolute upper/lower limit 6: Absolute upper limit 7: Absolute lower limit 8: Absolute upper/lower limit range 2 <sup>nd</sup> digit : Additional functions 0: No function 1: Hold 2: Standby sequence 3: Hold + standby sequence

<2> Event output delay timer setting: Mode indicator **E It**  
 Initial value: 0 sec.

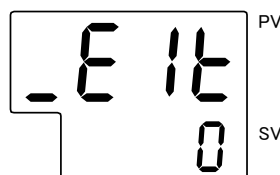

Setting range	0 to 9999 sec.
Indication	Event output delay timer setting: Indicates the event output delay timer setting mode is activated with “E It”.
Function	Sets the event output delay timer. Sets the delay time required to generate the event output after the conditions necessary for the event to occur are satisfied.

**[Tips]**

**Event output function**

An event output (condition) is an output (condition) whose purpose is to light up an alarm LED (AL1) and open the contact of a controller alarm output connector (upper/lower deviation alarm) when the product is in the event output range.

Event function	Output range
Upper/lower deviation limit	
Upper deviation limit	
Lower deviation limit	
Upper/lower deviation limit range	
Absolute upper/lower limit	
Absolute upper limit	
Absolute lower limit	
Absolute upper/lower limit range	

- △ : Target temperature position
- E1L : Lower setting limit for event
- E1H : Upper setting limit for event
- ▨ : Event output range

The set values on the table (E1L, E1H) show the range when a positive value is input.



**[Tips]**

---

**Additional functions for the event output function setting**

Nothing: No additional function. When the product is in the event output range, the event output continues.

Holding: When the product attains an event output condition, the event output continues even after the product leaves the event output range.

Standby sequence: Immediately after the power supply is turned on or an even output is set, the product enters standby and the event output does not start even if the product is in the event output range. This standby condition will be released when the product leaves the event output range, and the event output will be generated when the product returns to the event output range again.

Holding + Standby sequence: Functions of both the holding and standby sequences are provided.

---

### 5.4.12 Selection of Communication Setting Mode

Inputting “6” in the setting mode “SEt” activates the communication setting mode. Each press of the [MODE] key changes the operating mode as follows.

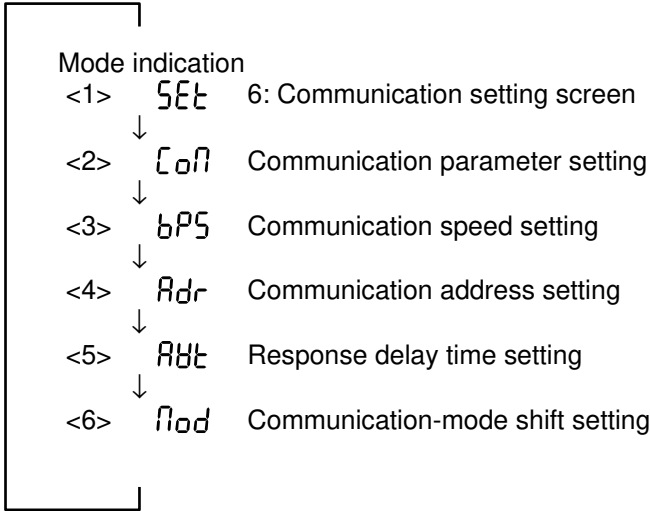

### 5.4.13 Details of Communication Setting Mode

<1> Communication parameter setting: Mode indicator CoM  
Initial value: b8n2

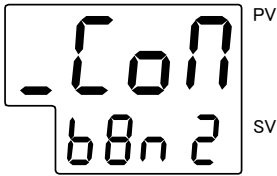

Setting range	1 <sup>st</sup> digit : 1、2 2 <sup>nd</sup> digit : n、o、E 3 <sup>rd</sup> digit : 7、8 4 <sup>th</sup> digit : n、b
Indication	Communication parameter setting: Indicates the communication parameter setting mode is activated with “CoM”.
Function	Sets various parameters related to communication. The number of digits is counted from the right side. 1 <sup>st</sup> digit : Stop bit length function 1: 1 bit, 2: 2 bit 2 <sup>nd</sup> digit : Parity check function n: Without, o: Odd, E: Even 3 <sup>rd</sup> digit : Data length selection 7: 7 bit, 8: 8 bit 4 <sup>th</sup> digit : BCC check function n: Disable, b: Enable

<2> Communication speed setting: Mode indicator *bPS*  
Initial value: 9.6

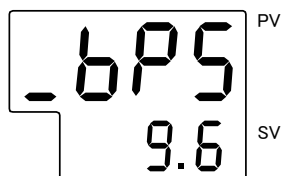

Setting range	1.2 to 19.2 (1200bps to 19200bps)
Indication	Communication speed setting: Indicates the communication speed setting mode is activated with "bPS".
Function	Sets the communication speed. The set value can be scrolled with the ▲ and ▼ keys. 1.2 ⇄ 2.4 ⇄ 4.8 ⇄ 9.6 ⇄ 19.2

<3> Communication address setting: Mode indicator *Adr*  
Initial value: 1 address

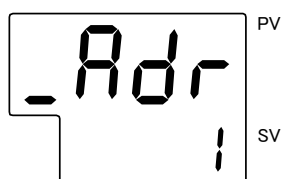

Setting range	1 to 99 addresses
Indication	Communication address setting: Indicates the communication address setting mode is activated with "Adr".
Function	Sets the communication address of the product.

<4> Response delay time setting: Mode indicator *Rdt*  
Initial value: 0ms

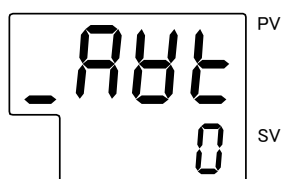

Setting range	0 to 250ms
Indication	Response delay time setting: Indicates the response delay time setting mode is activated with "Rdt".
Function	Sets the response delay time.

<5> Communication-mode shift setting: Mode indicator *Mod*  
Initial value: *rb*

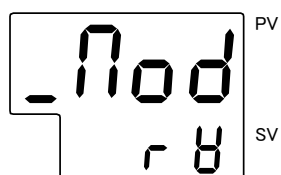

Setting range	<i>rd</i> , <i>rb</i>
Indication	Communication-mode shift setting: Indicates the communication-mode shift setting mode is activated with "Mod".
Function	Sets the communication-mode shift setting. <i>rd</i> : Readable, <i>rb</i> : Readable and writable

## 5.4.14 Initial Value and Setting Range for Each Mode

Table 5-2 Initial value and setting range for each mode

Description	Mode indicator	Initial value	Setting range
Setting of target temp.		25.0	-15.0 to 60.0
Offset setting	<i>P<sub>US</sub></i>	According to the Inspection Record	-1.0 to 1.0
Upper temperature limit range setting	<i>E<sub>IH</sub></i>	1.5	-20.0 to 65.0
Lower temperature limit range setting	<i>E<sub>IL</sub></i>	1.5	-20.0 to 65.0
Heating output indicator	<i>n<sub>U1</sub></i>	—	—
Cooling output indicator	<i>n<sub>U2</sub></i>	—	—
Function key setting	<i>FU</i>	1	0 to 4
Key lock setting	<i>LoC</i>	0	0 to 3
Control mode setting	<i>nd</i>	<i>rUn</i>	<i>rUn, rdy</i>
AT sensitivity setting	<i>AtC</i>	2.0	0.0 to 999.9
PB (heating) range setting	<i>P1</i>	7.0	0.1 to 200.0%
I constant setting	<i>I</i>	250	0 to 3600
D constant setting	<i>d</i>	0	0 to 3600
Heating for the proportional frequency setting	<i>t1</i>	2	1 to 120
ARW setting	<i>ARW</i>	100.0	0.0 to 100.0
PB (cooling) range setting	<i>P2</i>	0.50	0.0 to 10.00
Cooling for the proportional frequency setting	<i>t2</i>	2	1 to 120
Event output function setting	<i>E<sub>IF</sub></i>	01	1 <sup>st</sup> digit: 0 to 8 2 <sup>nd</sup> digit: 0 to 3
Event output delay timer setting	<i>E<sub>It</sub></i>	0	0 to 9999
Communication parameter setting	<i>Con</i>	<i>b8n2</i>	1 <sup>st</sup> digit: Stop bit length function 1: 1 bit, 2: 2 bit 2 <sup>nd</sup> digit: Parity check function <i>n</i> : Without, <i>o</i> : Odd, <i>E</i> : Even 3 <sup>rd</sup> digit: Data length selection 7: 7 bit, 8: 8 bit 4 <sup>th</sup> digit: BCC check function <i>n</i> : Enable, <i>b</i> : Disable
Communication speed setting	<i>bPS</i>	9.6	1.2 to 19.2 (1200bps to 19200bps)
Communication address setting	<i>Adr</i>	1	1 to 99
Response delay time setting	<i>ABt</i>	0	0 to 250
Communication-mode shift setting	<i>Mod</i>	<i>rB</i>	<i>r0, rB</i>

## 5.5 Alarms

### 5.5.1 Content of Alarms

Table 5-3 Content of alarm

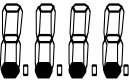
(Lit) 7seg. LED	Content of alarm	Alarm output	Temp. upper/lower limit alarm	Lit LED	Subsequent condition	Reset
<b>Normal status</b>	<b>Upper limit temp. alarm (initial setting)</b> Occurs when the sensor value exceeds the value obtained by adding the upper temp. limit to the set temp.	Contact opened	ON	<b>AL1</b>	Normal operation	Automatic-ally
<b>Normal status</b>	<b>Lower limit temp. alarm (initial setting)</b> Occurs when the sensor value is lower than the value obtained by subtracting the lower temp. limit from the set temp.	Contact opened	ON	<b>AL1</b>	Normal operation	Automatic-ally
<b>Normal status</b>	<b>Low DC power supply voltage (Power supply failure)</b> Occurs when the internal power supply has trouble.	Contact opened	-	<b>TROUBLE</b>	Control stop 1	Restart the power supply.
<b>Normal status</b>	<b>Thermostat alarm</b> Occurs when the thermostat that detects excessive heating begins operating.	Contact opened	-	<b>TROUBLE</b>	Control stop 1	Restart the power supply.
<b>Normal status</b>	<b>Fan alarm</b> Occurs when the fan has been revolving for 0.5 sec. continuously at an unacceptable rate.	Contact opened	-	<b>TROUBLE</b>	Control stop 1	Restart the power supply.
<b>Err0</b>	<b>Memory error</b> Occurs when the data stored inside of the EEPROM breaks.	-	-	-	Control stop 2	Replace the EEPROM.
<b>Err1</b>	<b>Controller error</b> Occurs when A/D conversion is not performed properly.	-	-	-	Control stop 2	Replace the circuit.
<b>Err2</b>	<b>Auto tuning error</b> Occurs when auto tuning is not finished after approx. 3 hours has passed since it started.	-	-	-	Control stop 2	*1) Press any operation key.
	<b>High temp. sensor value</b> Occurs when the temperature sensor breaks (or the signal cable is not connected).	Contact opened *2)	ON *2)	<b>AL1 *2)</b>	Control stop 2	Restart the power supply.
	<b>Low temp. sensor value</b> Occurs when the temperature sensor is short-circuited.	Contact opened *3)	ON *3)	<b>AL1 *3)</b>	Control stop 2	Restart the power supply.

\*1) When **Err2** occurs, the power supply to the thermo-module is cutoff and control is stopped. Pressing any operation key restarts control using the PID values that were in memory before auto tuning was started.

\*2) Except when no function, lower deviation limit, upper/lower deviation limit range, absolute lower limit, or absolute upper/lower limit range is selected in the event output function setting. Refer to page 5-15 "5.4.11 Details of EV Output Setting Mode".

\*3) Except when no function, upper deviation limit, upper/lower deviation limit range, absolute upper limit, or absolute upper/lower limit range is selected in the event output function setting. Refer to page 5-15 "5.4.11 Details of EV Output Setting Mode".

- ★Control stop 1: The thermo-module output and pump are stopped.
- ★Control stop 2: Only the thermo-module output is stopped.

## 5.5.2 Troubleshooting

Table 5-4 Troubleshooting

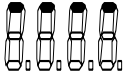
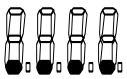
Code	Trouble	Remedy
<b>TROUBLE LED (red) lights up.</b>	High-level electric noise has been applied to the power supply line, ground line and signal line.	Move the product to an environment with less noise and restart the power supply. If no failure occurs, the noise is the cause.
	The internal power supply output has failed.	Confirm that the power supply voltage is AC100-240V.
	The recirculating fluid has been excessively heated.	Confirm that the recirculating fluid is not excessively heated.
		Confirm that the recirculating fluid level is not too low.
	The cooling water has been cutoff or its flow rate has slowed.	Supply the appropriate amount of cooling water.
The cooling fan for the Controller has stopped, or its revolution rate has decreased.	If the fan is stopped due to foreign matter, eliminate it.	
<b>Err0</b>	The EEPROM of the Controller is broken due to high-level electric noise.	If the trouble cannot be solved even after the power supply is restarted, contact SMC for repair.
	The writing time to the EEPROM exceeds 0.1 million.	
<b>Err1</b>	The EEPROM of the Controller is broken due to high-level electric noise.	If the trouble cannot be solved even after the power supply is restarted, contact SMC for repair.
<b>Err2</b>	Auto tuning has not finished within 3 hours due to insufficient cooling capacity.	Decrease the temperature of cooling water and supply it at 3 to 5L/min. In case the temperature is set to low, which results in decrease of cooling capacity, restart auto tuning after confirming indicated temperature comes close to set temperature.
	The temperature sensor is broken (or the signal cable is not connected).	Check if the signal cable is disconnected. If the trouble cannot be solved even after no disconnection is confirmed and the power supply is restarted, confirm there is no broken wire. If the wire is broken, contact SMC for repair.
	The temperature sensor is short-circuited.	Confirm that the temperature sensor and signal cable are short-circuited. If they are short-circuited, contact SMC for repair.
<b>The operation and display panel doesn't light up, or the display disappears.</b>	The internal temperature of the controller has increased and a protective circuit of the internal power supply has begun operating.	Check that the air vents (breathing port, exhausting port) are not plugged.
	An abnormality such as a short-circuit has occurred and the protective circuit for the power supply has begun operating.	If the trouble cannot be solved even after the power supply is restarted 3 or 4 min. after, contact SMC for repair.
	The circuit protector or externally installed earth leakage breaker has been tripped.	Confirm that an instantaneous power supply cutoff has not occurred at frequent rate. Confirm that a ground leakage has not occurred. If the trouble cannot be solved even after the power supply is restarted, contact SMC for repair.





# Chapter 6 Maintenance

- This product needs to be returned to the SMC factory for repair and maintenance.  
Essentially, on-site repairs and maintenance cannot be offered.
- Before returning the product for repair and maintenance, drain the recirculating fluid from the liquid tank and ensure that it is clean and dry. Any injury or damage to equipment during transport due to improper cleaning and drying of the product cannot be compensated.
- Obtain the form "Request for Return" from our sales branches. The purpose of this form is to ensure that the returned product is safe. Fill in the form, sign, and send it to our sales branches before returning the product.  
The contents of form will be checked, and you will be informed whether or not the return is acceptable.
- It is recommended that you prepare a back-up product to minimize machine downtime during repairs and maintenance.
- The packing box in which the product came has been made specifically for this product. Use this box to return the product to the SMC factory for repair or maintenance.

## 6.1 Before returning the product

### **WARNING**



**Drain the liquid from the liquid tank and clean and dry the product before returning it to the SMC factory for repair and maintenance. Any liquid left in the product could cause damage to the equipment during transport.**

### **CAUTION**



**Be sure to transport the product in a packing box specific to the Thermo Electric Bath.**



# Chapter 7 Appendix

## 7.1 Outline Dimensions

### 7.1.1 Liquid Tank

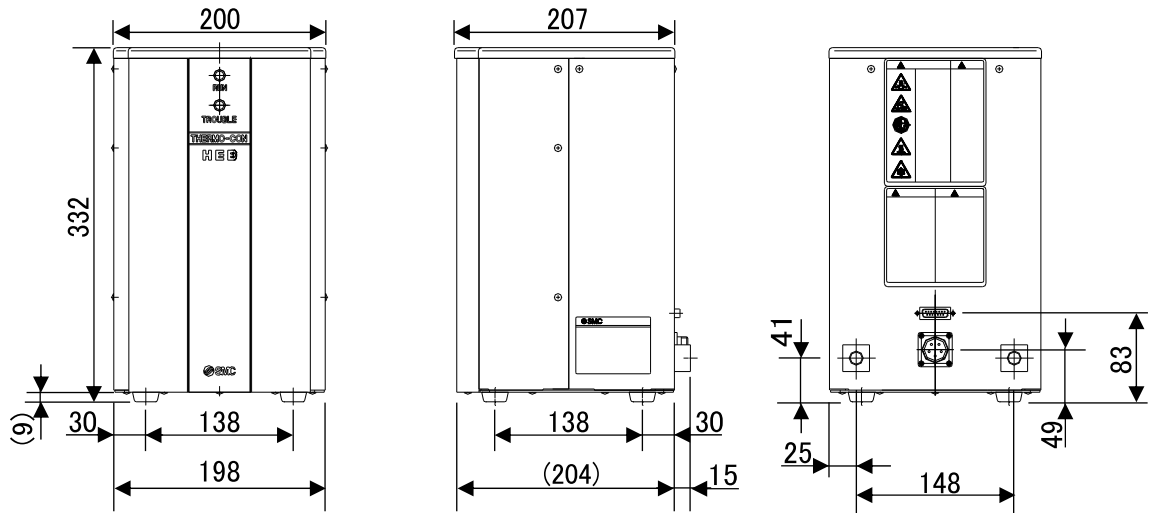

Fig. 7-1 Liquid Tank

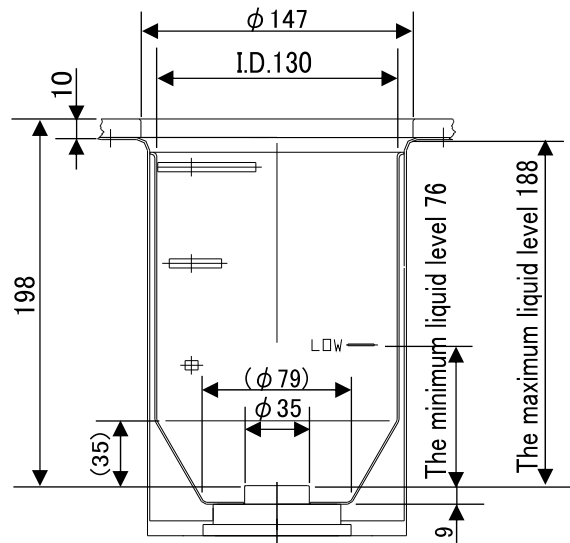

Fig. 7-2 Internal dimensions of Liquid Tank

### 7.1.2 Controller

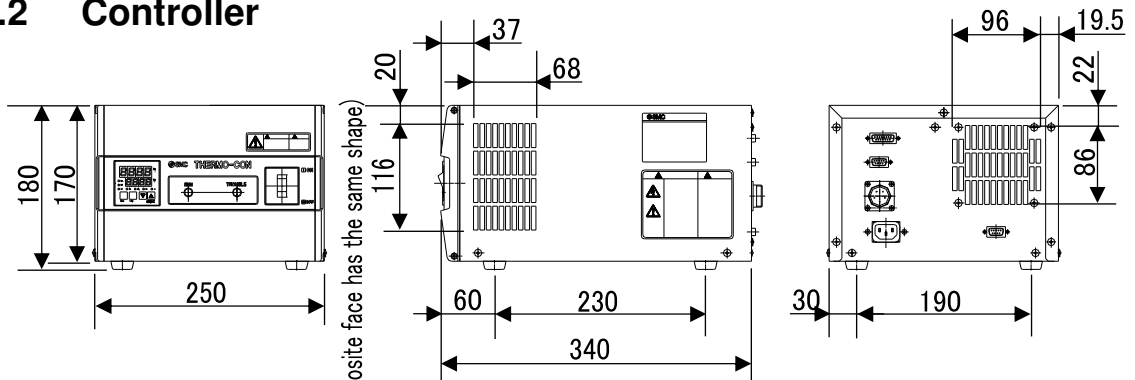

Fig. 7-3 Controller

## 7.2 Specifications

Table 7-1 Thermo Electric Bath specifications

Part no.		HEBC002-WA10	HEBC002-WB10
Control method		Cooling/heating automatic shift PWM control	
Cooling / Heating method		Thermoelectric device (Thermo-module)	
Radiating method	Liquid Tank	Water-cooled	
	Controller	Forcible air-cooled	
Operating temp. range		-15.0 to 60.0°C (5°C or more for water) (Note 1) (Note 5)	
Temp. stability		±0.01°C (Note 1)	
Temp. distribution		±0.02°C (Note 1)	
Cooling capacity		140W (Water) (Note 2)	
Heating capacity		300W (Water) (Note 2)	
Recirculating fluid	Application fluid	Water, GALDEN® HT135, HT200, Fluorinert™ FC-3283 (Note 3)	
	Tank dimensions	I.D. φ 130 × Liquid level 188mm (Note 6)	
Cooling water	Temperature	10 to 35°C (no dew condensation)	
	Flow rate	3 to 5L/min (Note 4)	
	Max. operating pressure	0.5MPa	
Cooling water port size		Rc1/4	
Power supply		AC100 to 240V, Single phase, 50/60Hz, 4 to 2A	
Overcurrent protection		Circuit protector (acting as a power supply switch) with rated current 10A	
Main functions		Auto tuning, Set value memory, Temp. upper/lower deviation limit alarm, Output cutoff alarm	
Communication		RS-485	RS-232C
Input operation Indication		Membrane key sheet 7 segment LED	
Alarm output		Temp. upper/lower deviation limit alarm, Output cutoff alarm Relay contact output: opened when the alarm occurs 125VAC, 0.4A/30VDC, 2A (resistive load), 125VAC, 0.2A/30VDC, 1A (inductive load)	
Temperature sensor		Resistance thermometer sensor, Pt100 Ω, 3-Connecting wire, Class A, JIS C 1604	
Ambient temp./humidity Ambient air quality		10 to 35°C, 35 to 80%RH (no dew condensation) Appropriate environment without corrosive gas, solvent such as thinner and combustible gas.	
Dimensions	Liquid Tank	W 200 × H 332 × D 207mm(excluding protrusion)	
	Controller	W 250 × H 180 × D 340mm(excluding protrusion)	
Weight	Liquid Tank	Approx. 8.5kg (Empty)	
	Controller	Approx. 6.5kg	
Connection cable		DC cable, Signal cable: 3m each	
Accessory cable		Power supply cable: 2m	

Note 1) Differs depending on operating conditions.

Note 2) Determined under the following conditions: water as the recirculating fluid, set temperature 25°C, cooling water temperature 25°C, flow rate 3L/min, ambient temperature 25°C, and sealed from outside air with a lid.

Note 3) GALDEN® is a trade mark of Solvay Solexis and Fluorinert™ is a trade mark of 3M.

Note 4) An appropriate range is from 3 to 5L/min. To prevent damage to the radiating system, do not supply a flow over the maximum flow rate of 8L/min.

Note 5) When the temperature is set high, the liquid temperature inside of the liquid tank and the temperature inside of the thermostat could differ greatly depending on the heating mode at start-up, and the thermostat could then begin operating and stop the output.

Note 6) 1. Do not use the thermo electric bath under the condition where the circulating fluid splashes or leaks out. Otherwise, peripheral equipment as well as the thermo electric bath can break.

2. When the set temperature is increased from a low value to an ordinary value, some kinds of the circulating fluid can swell, increase and overflow, which can not only break the thermo electric bath and other equipment, but also cause a serious accident. Take a measure to prevent this situation in advance by decreasing the amount of the circulating fluid, etc.

■ **Pollution Degree**

The pollution degree is a classification from 1 to 4 degrees depending on the pollution present in the air. This product is suitable for environments with a pollution degree of 1 or 2.

<b>Degree 1</b>	There is no pollution or only dry and nonconductive pollution occurs. An example of an environment of this degree is a clean room or a place using an air cleaner.
<b>Degree 2</b>	Normally, only nonconductive pollution occurs. The pollution may become conductive temporarily because of dew condensation. An example of an environment of this degree is a place where electric equipment can operate normally, such as a working office or a control panel.
<b>Degree 3</b>	Conductive pollution or dry and nonconductive pollution which can become conductive when dew condensation occurs. An example of an environment of this degree is a factory.
<b>Degree 4</b>	Conductive pollution that holds its conductivity due to conductive dust, rain or snow. An example of an environment of this degree is the outdoors.

**CAUTION**



**This product can be used only in environments with a pollution degree of 1 or 2.**

## 7.3 Specifications of Connectors

### 7.3.1 Connection of Liquid Tank and Controller

#### ■ Liquid Tank connector

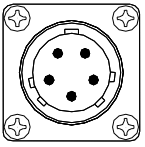
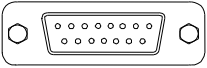
<p>DC connector (male)</p> <p>Nanaboshi Electric Mfg.co.,Ltd:          NJC-245-RM UL CSA</p> 	<p>Signal connector (male)</p> <p>Hirose Electric co.,Ltd: CDA-15P(05)          Fixed screw M2.6</p> 
--	--

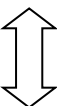
Connected 

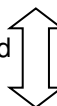
Connected 

#### ■ Connection cable

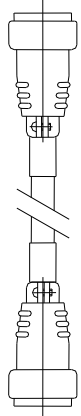
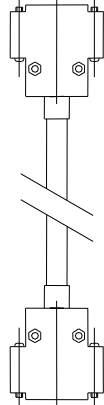
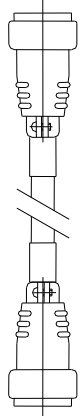
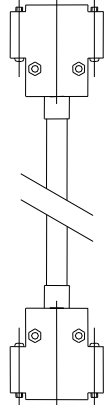
<p>DC cable</p> <p>Nanaboshi Electric Mfg.co.,Ltd:          NJC-245-PF UL CSA          Female</p> 	<p>Signal cable</p> <p>Hirose Electric co.,Ltd: CDA-15S(05)          Fixed screw M2.6          Female</p> 
<p>Male</p> <p>Nanaboshi Electric Mfg.co.,Ltd:          NJC-245-PM UL CSA</p> 	<p>Male</p> <p>Hirose Electric co.,Ltd: CDA-15P(05)          Fixed screw M2.6</p> 

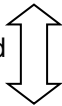
Connected 

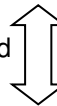
Connected 

#### ■ Controller connector

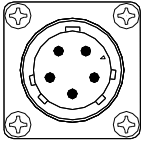
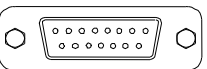
<p>DC output connector (female)</p> <p>Nanaboshi Electric Mfg.co.,Ltd:          NJC-245-RF UL CSA</p> 	<p>Signal connector (female)</p> <p>Hirose Electric co.,Ltd: CDA-15S(05)          Fixed screw M2.6</p> 
---	--

### 7.3.2 Connection of Power Supply Cable

■ **Controller connector**

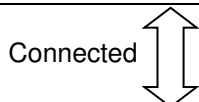
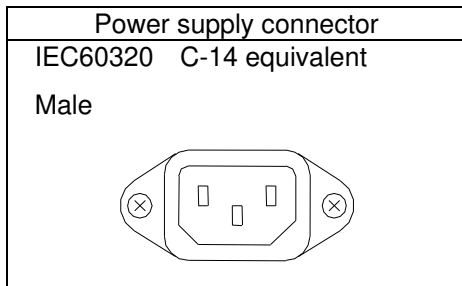

■ **Power supply cable**

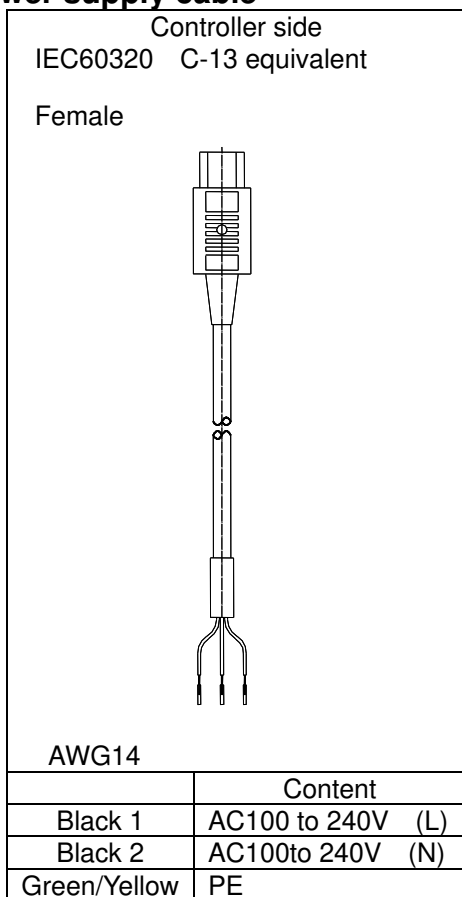



### 7.3.3 Connector for External Equipment

Prepare mating connectors for communication connector and alarm output connector by customer separately.

#### ■ Alarm output connector

Hirose Electric co.,Ltd: CDE-9P(05) Fixed screw M2.6  
 Mating connector: CDE-9S(05) equivalent

Pin no.	Content
1	Temp. upper/lower deviation limit alarm contact (opened for alarm)
2	Temp. upper/lower deviation limit alarm common
3-4	Unused
5	Output cutoff alarm contact (opened for alarm)
6	Output cutoff alarm common
7-9	Unused

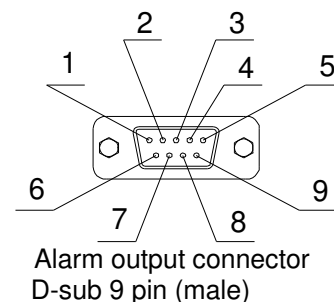

#### ■ Communication connector

Hirose Electric co.,Ltd: CDE-9S(05) Fixed screw M2.6  
 Mating connector: CDE-9P(05) equivalent

Pin no.	Content	
	HEBC002-WA10	HEBC002-WB10
1	RS-485 T/R(A)	Unused
2	RS-485 T/R(B)	RS-232C RX
3	Unused	RS-232C TX
4	Unused	Unused
5	Unused	RS-232C SG
6-9	Unused	Unused

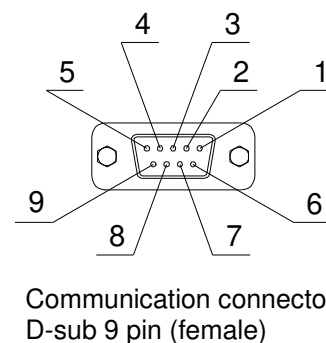

## 7.4 Communication

### 7.4.1 Specifications

Table 7-2 Communication

Communication type	HEBC002-WA10	HEBC002-WB10
Protocol	RS-485	RS-232C
Circuit type	Half duplex	Half duplex
Communication type	Asynchronous	Asynchronous
Communication speed (BPS)	1200/2400/4800/ <u>9600</u> /19200	1200/2400/4800/ <u>9600</u> /19200
Character code	ASCII	ASCII
Interface	2-wire	3-wire
Parity	<u>Without</u> /Odd/Even	<u>Without</u> /Odd/Even
Start bit	1 bit	1 bit
Data length	7/ <u>8</u> bit	7/ <u>8</u> bit
Stop bit	1/ <u>2</u> bit	1/ <u>2</u> bit
BCC check	Disable / <u>Enable</u>	Disable/ <u>Enable</u>
Address	<u>1</u> to 99	<u>1</u> to 99

The settings are as underlined at the time of shipment from the factory.

### 7.4.2 Communication Procedure

This product receives a “request message” from the master computer and sends back a corresponding “response message”. It does not send a message firstly.

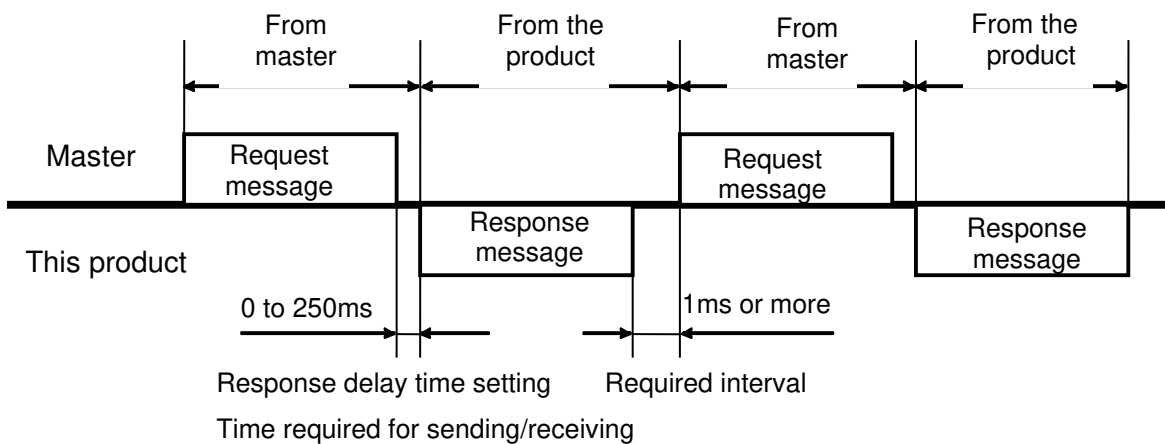

### 7.4.3 Type of Message

The type of message can essentially be divided into the following categories.

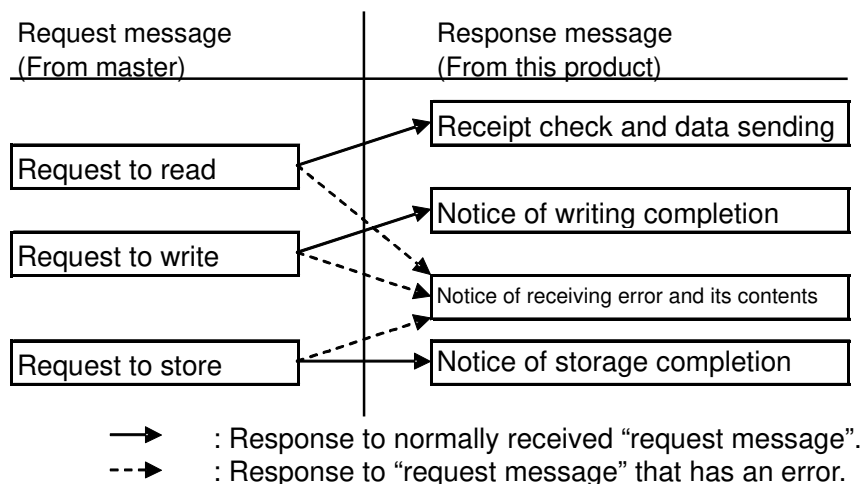

All codes, including STX and data (except for BCC), are expressed with ASCII code.

When the master is programmed, refer to page 7-18 "7.4.11 Identification Code List" and "7.4.12 ASCII Code List".

### 7.4.4 Content of Communication

The content that can be communicated is as follows:

- 1) Reading of measured temperature
- 2) Setting and reading of target temperature
- 3) Setting and reading of offset value
- 4) Storage of set value

#### **[Tips]**

All set values input by communication function are not stored. If they need to be stored, send a request message to store them in accordance with page 7-10 "7.4.5 Composition of Required Message (from master to the product)".

### 7.4.5 Composition of Required Message (from master to the product)

Refer to page 7-12 “7.4.7 Explanation of Code” for codes 1 to 10.

■ **Composition of request message to read**

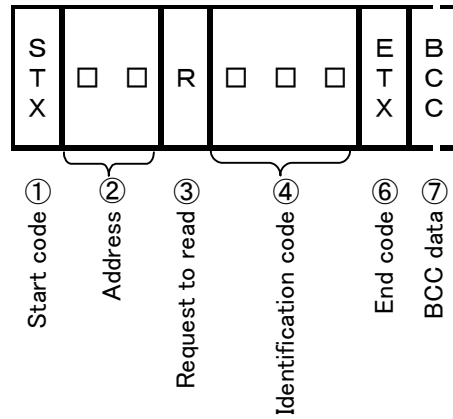

■ **Composition of request message to write**

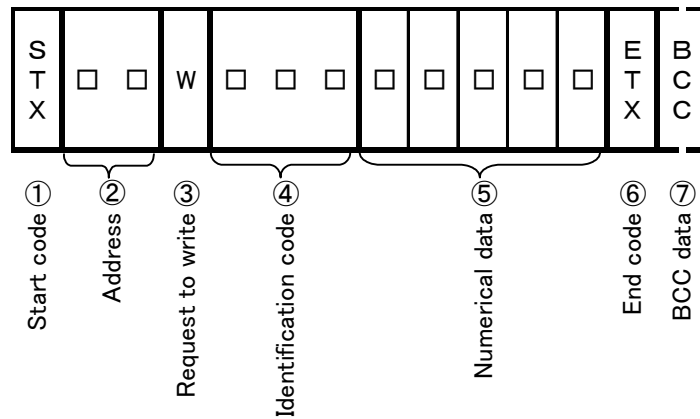

■ **Composition of request message to store**

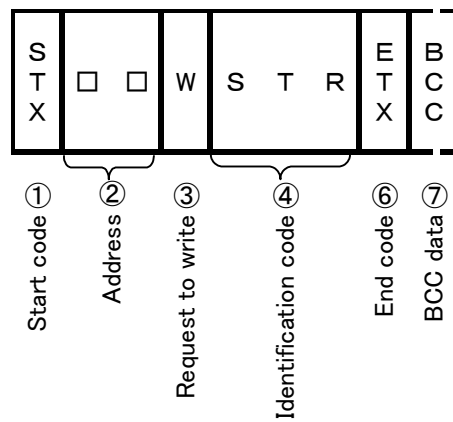

## 7.4.6 Composition of Response Message (from the product to master)

Refer to page 7-12 “7.4.7 Explanation of Code” for codes 1 to 10.

### ■ Response message to request message to read

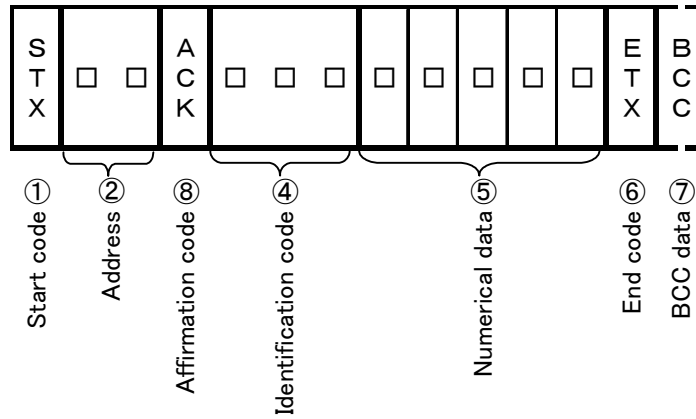

### ■ Response message to request message to write and store

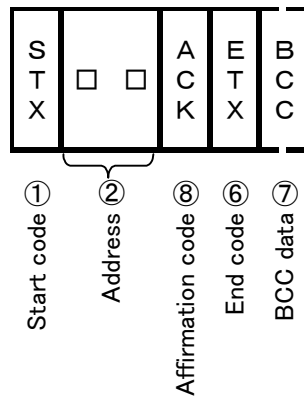

### ■ Response message to error

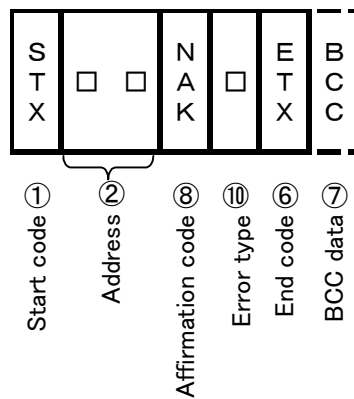

### 7.4.7 Explanation of Code

- ① STX  
The code necessary for the receiver to detect the beginning of a message. It is put at the beginning of sent characters.
- ② Address  
The address to which (this product) the master communicates. The address in a response message from this product shows where the message is sent.
- ③ Content  
One of two symbols, R or W.  
R: Read data from the product  
W: Write or store data to the product
- ④ Identification  
The classification symbol (identification code) of read or written data with 3 digit alphabetical ASCII codes. Refer to page 7-18 “7.4.11 Identification Code List”.
- ⑤ Numeric data  
Read or written data with 5 digits regardless of its type.  
Minus data: “- (symbol for minus)” is displayed at the 1<sup>st</sup> digit  
Position of decimal point: Not included in 5 digit data.  
Ex) The 5 digit numeric data “00010” means

Ex.	Meaning of numerical data
Target temp., measured temp., and offset value	1.0°C

- ⑥ ETX  
The code necessary for the receiver to know the message is complete. It is put at the end of sent characters (except for BCC).
- ⑦ BCC  
Exclusive OR (EX-OR) of all characters from STX to ETX are taken in. If BCC check is set to “no function” in the communication setting mode of the product, this code is not included in the “response message”.
- ⑧ ACK  
The affirmation code included in the “response message” of the product; it is sent when the received “request message” contains no errors.
- ⑨ NAK

The negation code included in the “response message” of the product and sent with error type information (refer to “⑩ Error type”) when the received “request message” contains an error.

⑩ Error type

When the “request message” received by the product contains an error, the content of the error is included and sent subsequently to the “NAK” of the “response message”. If there are multiple errors, then the error that has been assigned the largest number is included and sent.

Table 7-3 Content and classification of errors

Error no.	Content of the error in a “request message”	
0	Memory error or controller failure	It replies regardless of the content of “request message”.
1	The numeric data is out of the “set range specified individually for each setting item”.	
2	Changing of a required item is prohibited or there are no items to be read.	Change prohibition occurs when $r \square$ (readable) is set to a communication-mode shift setting or the measured value (PV1) is changed. PV1 can be read only, cannot be written if $r \text{H}$ (readable and writable) is selected in the communication-mode shift setting.
3	The numeric data is given an ASCII code other than the one for numeric data.  The position for the symbol is assigned an ASCII code other than “0” or “-“.	
4	Format error	
5	BCC error	
6	Overrun error	
7	Framing error	
8	Parity error	
9	PV error occurs during auto tuning.  Auto tuning is not completed after 3 hours have passed.	It replies regardless of the content of “request message”.

## 7.4.8 Cautions for Communication

Pay attention to the following points for communication.

① Operation after the power supply is turned on

The product cannot communicate for approx. 6 sec. after the power supply is turned on. (No communication). Allow a time delay before starting communication after the power supply is turned on.

② Timing for sending and receiving

Allow a time delay for response to ensure the transition between sending from the master and receiving when using RS-485 or RS-232C.

③ Requesting interval

When a "request message" is sent continuously from the master, allow an interval of 1ms or more after receiving the "response message" from the product.

④ Response requirements

The product will not send a "response message" if STX and ETX (BCC) are not included in the "request message". That is, if the "request message" contains an error, the "response message (to the error)", including NAK and ERR, is not sent. If the "response message" is not returned for a significant period after the "request message" is sent from the master, check the message and resend the necessary "request message".

⑤ Address designation error

When this error occurs, the product does not respond to a "request message" which specifies an address other than the set one. If the "response message" is not returned after a significant period, check the message and resend the necessary "request message".

⑥ Number of data digits and position of decimal point

Read or written data is expressed with 5 digits, regardless of its type. Refer to page 7-12 "7.4.7 Explanation of Code⑤".

⑦ Operation after "request message to store" is received

The product begins to store data after receiving a "request message to store" from the master. Only the data that has a different content from the EEPROM (data that has been changed) is stored. The time required for storage is approx. 6 sec. The product responds (sends an ACK) after the data storage is completed.

If the power supply is turned off during the storing process, the data might not be stored. Do not turn off the power supply before the storage completion message is received.

⑧ Storage of data other than the "request message to store"

When a parameter is changed with a key-in operation, the product stores all parameters into the EEPROM even if not receiving a "request message to store".



⑨ Change of set value (SV) due to communication during auto tuning

The set value SV can be changed even during auto tuning. When auto tuning (automatically or manually) is completed, the changed set value will become valid. (While auto tuning is running, the set value does not change.)

### 7.4.9 Communication Example

■ Communication example of request message to read

Request message from master: Request the product having a set address of 10 to read the measured temperature at that moment.



Response message from the product: Send the measured temperature (00250) at that moment.

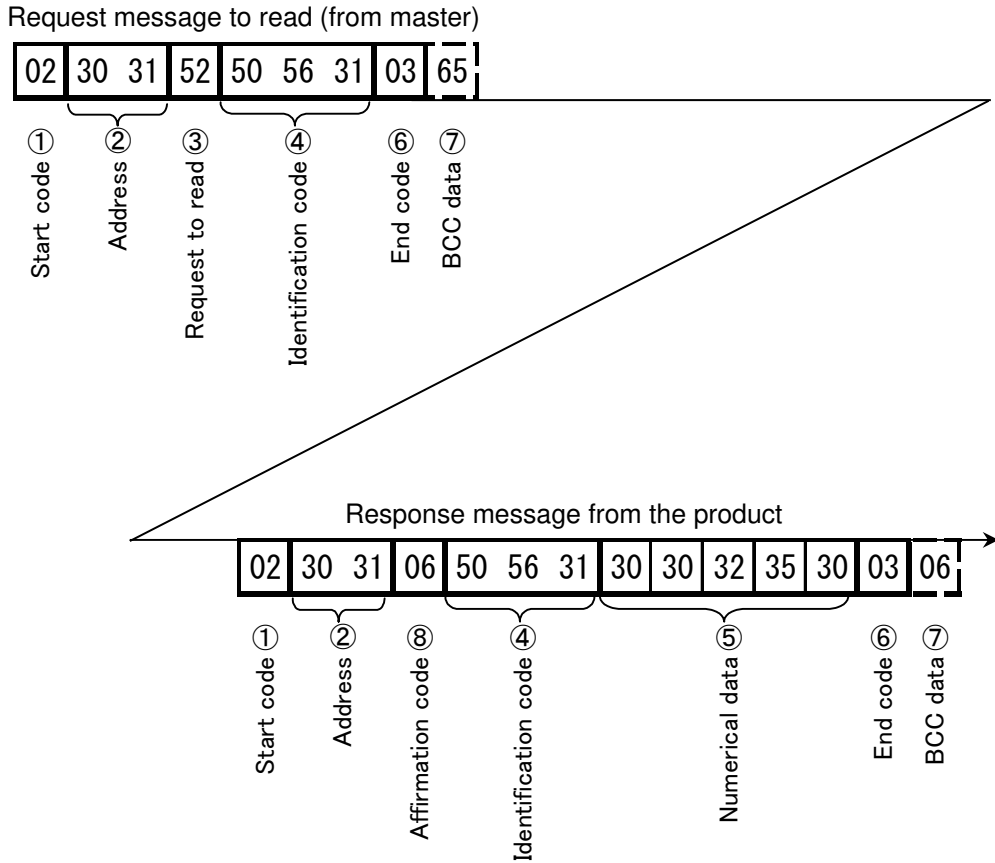

Code	Symbol/Data	ASCII code
① Start code	STX	02H
② Address	01	30H 31H
③ Required content	R (read)	52H
④ Identifier	PV1	50H 56H 31H
⑤ Numeric data	00250	30H 30H 32H 35H 30H
⑥ End code	ETX	03H
⑦ BCC data: Request		65H
Response		06H
⑧ Acknowledge code	ACK	06H

■ Communication example of request message to write

Request message from master: Request the address having a set address of 10 to set the target temperature to 20.0°C.



Response message from the product: Notice it received the request message properly.

☆ Confirm whether or not data is written correctly by reading the data separately.

Request message to write (from master)

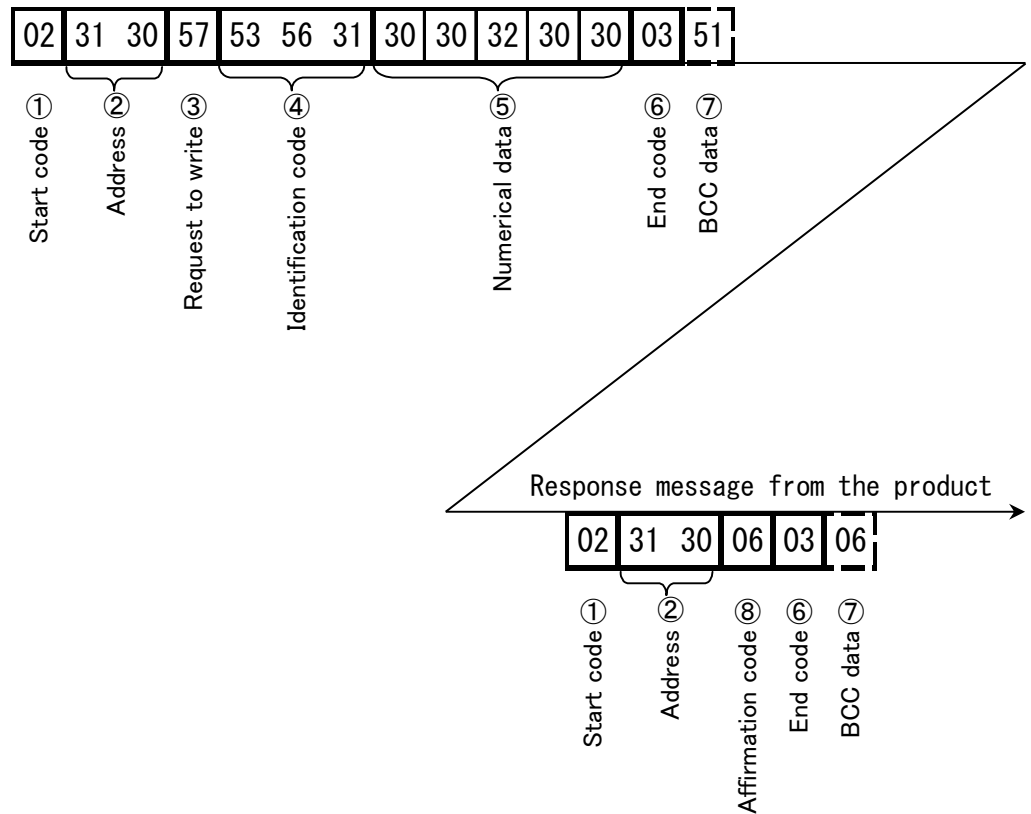

Code	Symbol/Data	ASCII code
① Start code	STX	02H
② Address	10	31H 30H
③ Required content	W (write)	57H
④ Identifier	SV1	53H 56H 31H
⑤ Numeric data	00200	30H 30H 32H 30H 30H
⑥ End code	ETX	03H
⑦ BCC data: Request		51H
	Response	06H
⑧ Acknowledge code	ACK	06H

### 7.4.10 Connection (for RS-485)

A terminal resistance needs to be mounted on the master and slave that are placed the furthest from each other. The resistance must be suitable for the characteristic impedance of the cables used for connection and have a combined resistance of 75 ohms or more.

### 7.4.11 Identification Code List

The following parameters can be changed.

Table 7-4 List of identifiers (codes)

Identifier	Description	R/W
PV1	Measured value (PV)	Read
SV1	Set value (SV)	Read/Write
PVS	Offset setting	Read/Write
STR	Data storage	Write

### 7.4.12 ASCII Code List

Table 7-5 ASCII code

ASCII code	02H	03H	06H	15H						
Code used	STX	ETX	ACK	NAK						

ASCII code	30H	31H	32H	33H	34H	35H	36H	37H	38H	39H
Number used	0	1	2	3	4	5	6	7	8	9

ASCII code	2DH	20H								
Number used	- Minus	SP Space								

ASCII code	41H	42H	43H	44H	45H	46H	47H	48H	49H	4AH
Character used	A	B	C	D	E	F	G	H	I	J

ASCII code	4BH	4CH	4DH	4EH	4FH	50H	51H	52H	53H	54H
Character used	K	L	M	N	O	P	Q	R	S	T

ASCII code	55H	56H	57H	58H	59H	5AH				
Character used	U	V	W	X	Y	Z				

## 7.5 Performance Chart

The values shown on the performance chart are representative and not guaranteed. Allow a margin for safety to decide use of the product.

### 7.5.1 Cooling Capacity

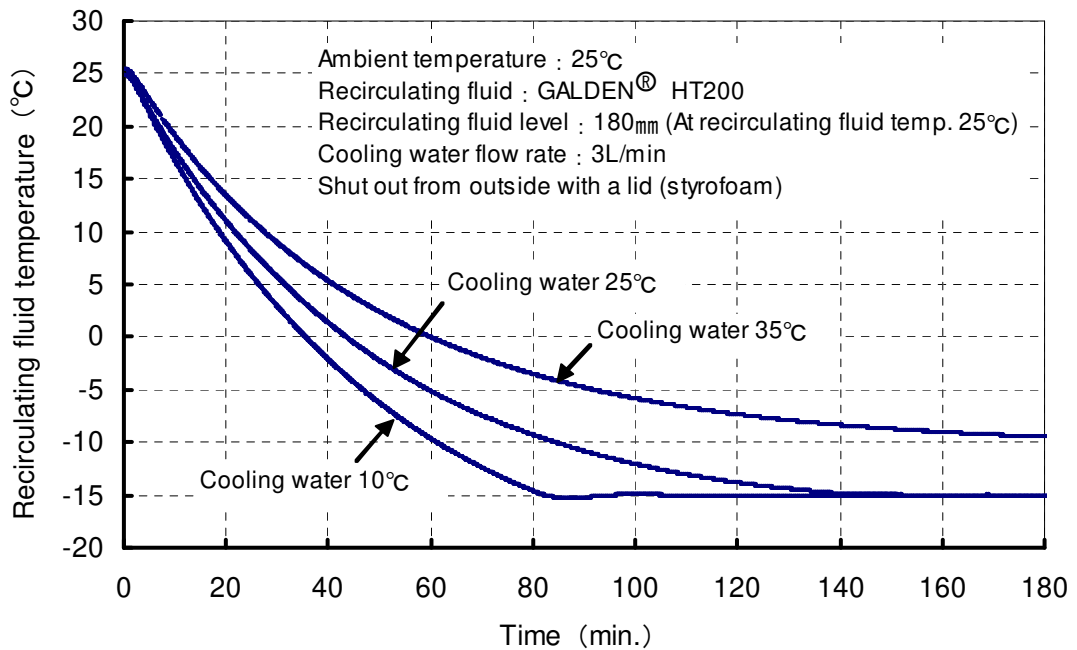
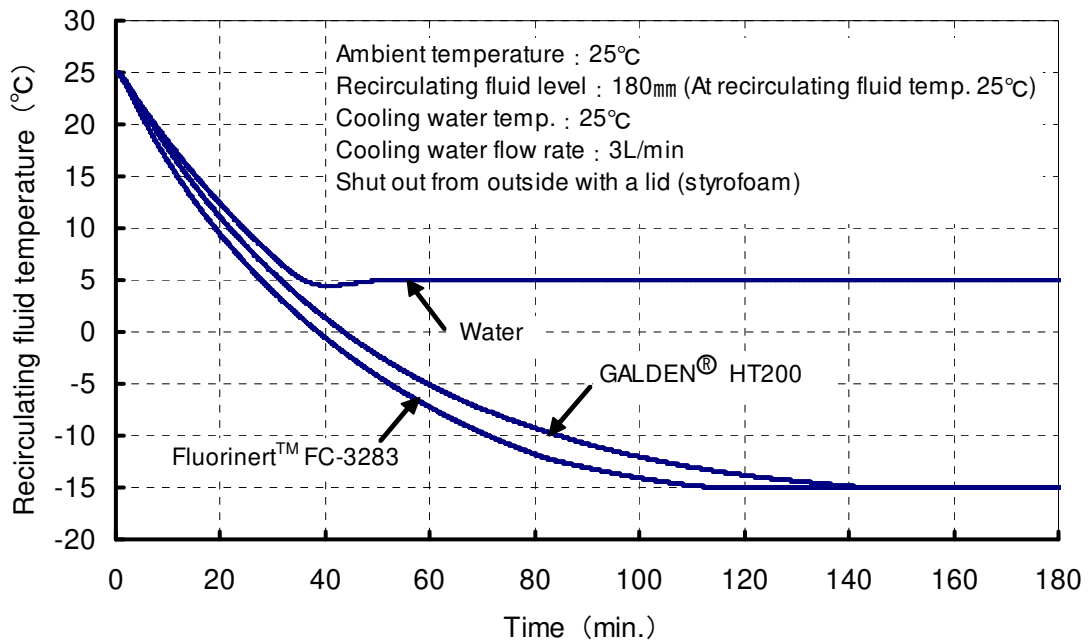

Fig. 7-4 Cooling capacity

### 7.5.2 Heating Capacity

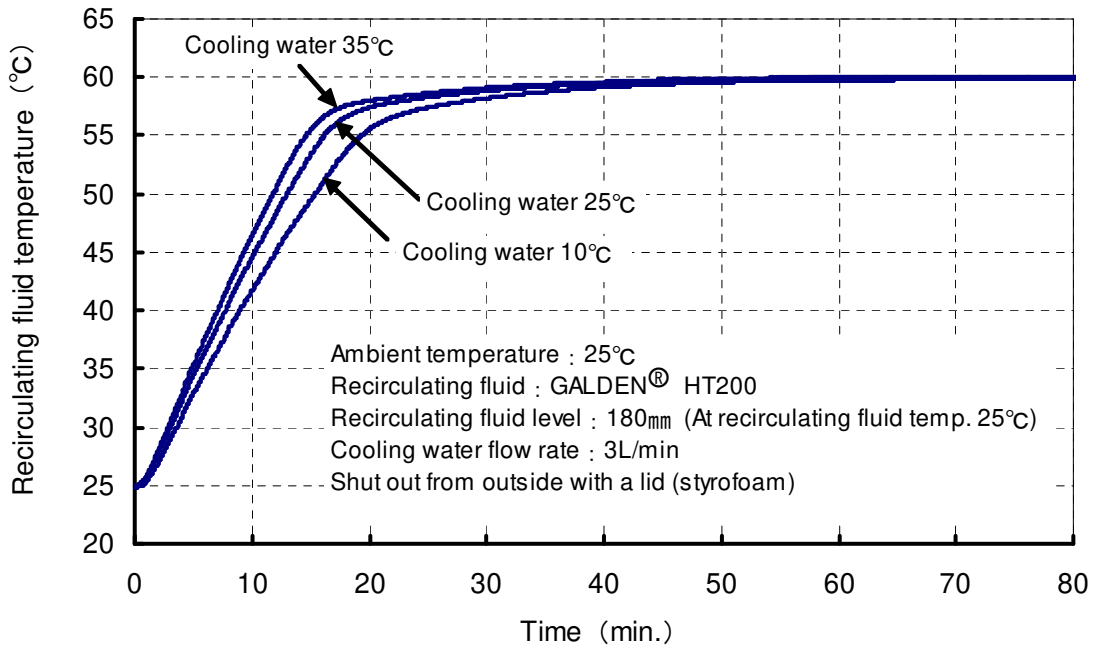
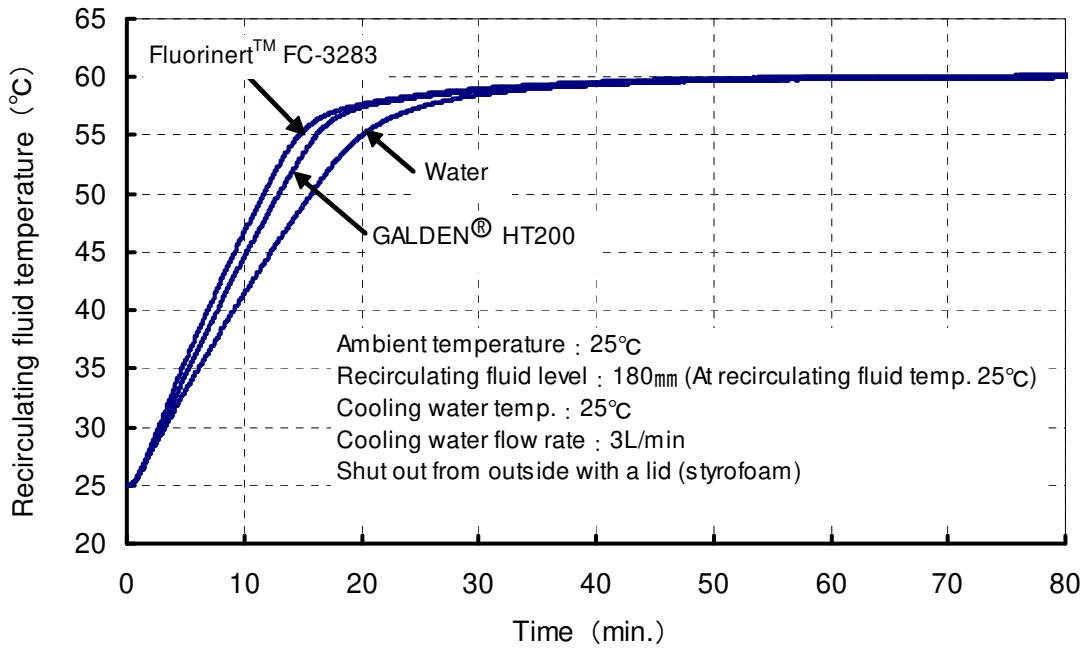

Fig. 7-5 Heating capacity

### 7.5.3 Cooling Water Pressure Loss

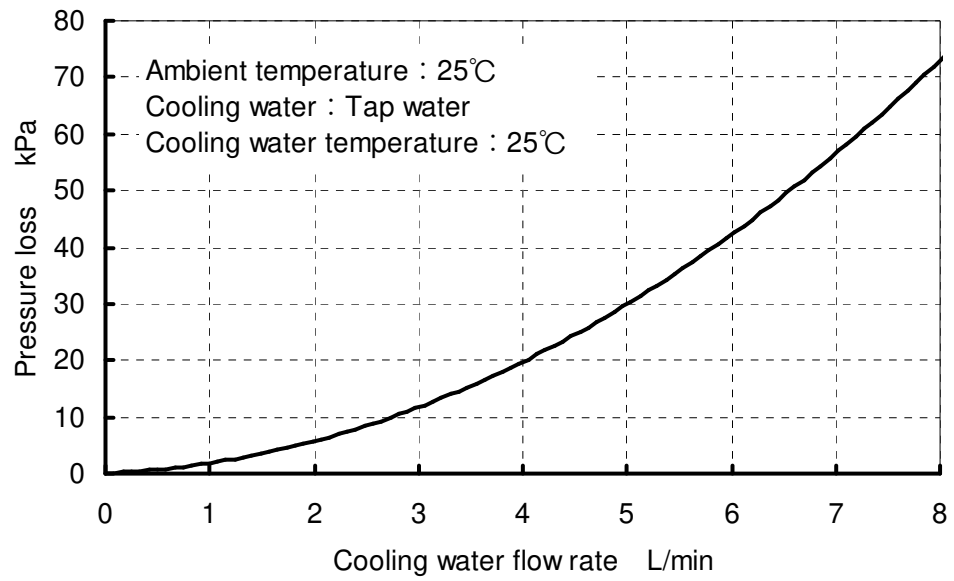

Fig. 7-6 Radiating water pressure loss

## 7.6 Calculation of Dew Point Temperature (from psychrometric chart)

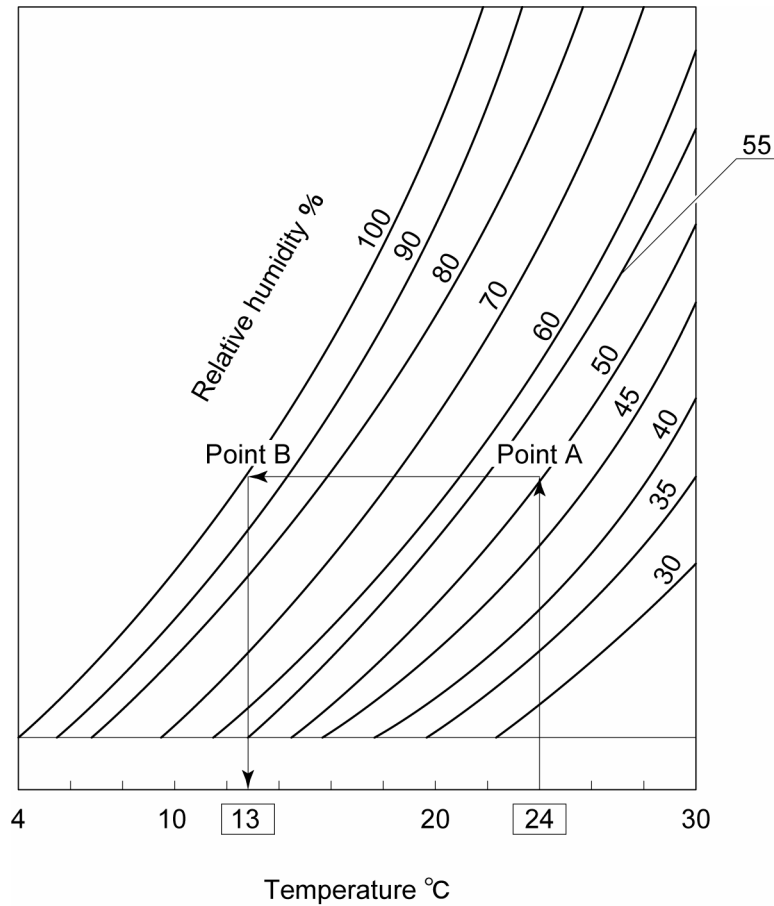

Fig. 7-7 Psychrometric chart

1. Measure the ambient temperature and humidity.
2. Plot the ambient temperature on the X axis, "Temp." (ex. 24°C), and draw a vertical line from there.
3. Find the intersection (A) between the curve with the value closest to the ambient humidity and the straight vertical line.
4. Draw a line parallel to the X axis from intersection A and find the intersection (B) between this line and the curve representing 100% relative humidity.
5. Draw a vertical line to the X axis from intersection B. The temperature at the intersection between this line and the X axis is the dew point (in this example, 13°C). If the temperature falls to this value, the moisture contained in the air will begin to form condensation.



# Chapter 8 Warranty

## (1) Content

If the purchased product fails, it will be repaired at no cost within the period and requirements mentioned below.

Replacement, adjustment, and inspection of failed parts are all within the range of this warranty, i.e., will be performed at no cost. The parts removed for repair will belong to SMC.

## (2) Period

1 year after delivery to the place customer speafied.

## (3) Scope of warranty

If the product fails within the warranty period and the fault lies with SMC, compensation will be provided at no cost.

## (4) Out of scope

The following situations are out of the scope of this warranty.

- ① The failure was caused by operation different from that shown in this manual or operation over the SMC specified parameter limits.
- ② The failure was caused by retrofitting that SMC did not approve.
- ③ The failure was caused by a recirculating fluid or cooling water with specifications other than those specified by SMC.
- ④ The failure occurred naturally over time (such as discoloration of a painted or plated face).
- ⑤ The failure does not affect the functioning of the product (such as new sounds, noises and vibrations)
- ⑥ The failure was caused by a natural disaster such as an earthquake, typhoon, or flood, or by an accident or fire.
- ⑦ The failure was caused by installation of the product in an environment other than that specified in this manual.

## (5) Disclaimer

The following are not covered by this warranty.

- ① Expenses to compensate for secondary damages to other equipment and goods due to the failure of the product
- ② Expenses for repairs performed by other companies
- ③ Expenses for transfer, installation and removal of the product
- ④ Expenses for replacement of parts other than those in the product and for the supply of liquids
- ⑤ Losses resulting from the inability to use the product (such as telephone charges, compensation for workplace closings, and commercial losses)
- ⑥ Expenses and compensation not covered in "(1) Content".
- ⑦ Expenses for returning the product

## (6) Request for repair

When repair of the product is needed, contact the shop where the product was purchased. When this is done, the repair will then be performed under warranty by SMC.

No-cost repair of the product is assured within the period and requirements mentioned above. Failures which occur after the warranty period has passed will, in principle, be charged.



Revision history
Rev 5: May, 2024

**SMC Corporation**

URL <https://www.smcworld.com>

---

Note: Specifications are subject to change without prior notice and any obligation on the part of the manufacturer.  
© SMC Corporation All Rights Reserved