



Operation Manual

PRODUCT NAME

Compact Wireless Base

MODEL / Series / Product Number

EXW1-BMJA#

PRODUCT NAME

Compact Wireless Remote

MODEL / Series / Product Number

EXW1-RDX#E4##

EXW1-RDY#E4##

EXW1-RDM#E3##

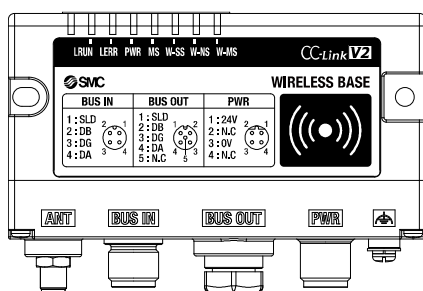

EXW1-BMJA#

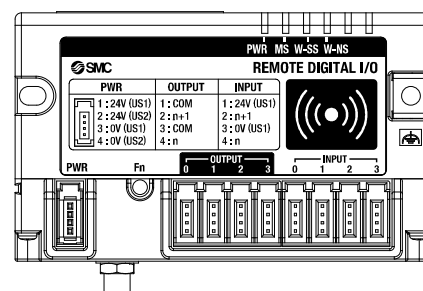

EXW1-RD#

SMC Corporation

Table of Contents

Safety Instructions	3
Limited warranty and Disclaimer/Compliance Requirements	4
Important Instructions concerning the Wireless System	10
SMC Wireless System	11
Features and Summary	11
System Configuration	12
System compatibility	13
How to Order	17
Summary of Product parts	18
EXW1-BMJA*	18
EXW1-RD*	21
Setting and Adjustment	28
Flow chart for operating the wireless system	28
I/O Configurator (NFC version)	29
Preparation	30
Installation of the software	30
Before starting the software	31
Download the I/O Configurator (NFC version)	34
Start the I/O Configurator (NFC version)	35
Screen Layouts of the I/O Configurator (NFC Version)	36
Monitoring and setting up	38
Setting/Adjustment of the Wireless Unit	39
Parameter settings of a Remote (optional)	39
Remote setting	39
Parameter settings of the Base	41
CC-Link setting	41
System setting	43
Frequency channel select function (F.C.S.)	46
Event	48
Wireless	50
Pairing and Unpairing Procedures	52
Pairing Procedure	52
Unpairing Procedure	57
Mounting and Installation of Units	59
EXW1-BMJ*, EXW1-RD*	59
Troubleshooting	62
Technical Information	73
I/O Map	73
I/O Mapping	75
Diagnostics Mapping	75
I/O Mapping Order When EX600-WSV* is Paired	76
I/O Mapping Order When EX600-WEN* or EX600-WPN* is Paired	80
Diagnostics map details	86
Number of remote registrations	93
Specifications	94
Dimensions	94
Specifications Table	96
Accessories	100
Accessory List	100



Safety Instructions

These safety instructions are intended to prevent hazardous situations and/or equipment damage. These instructions indicate the level of potential hazard with the labels of “**Caution**,” “**Warning**” or “**Danger**.” They are all important notes for safety and must be followed in addition to International Standards (ISO/IEC)^{*)}, and other safety regulations.

*1) ISO 4414: Pneumatic fluid power - General rules and safety requirements for systems and their components
ISO 4413: Hydraulic fluid power - General rules and safety requirements for systems and their components
IEC 60204-1: Safety of machinery - Electrical equipment of machines - Part 1: General requirements
ISO 10218-1: Robots and robotic devices - Safety requirements for industrial robots - Part 1: Robots
etc.



Danger

Danger indicates a hazard with a high level of risk which, if not avoided, will result in death or serious injury.



Warning

Warning indicates a hazard with a medium level of risk which, if not avoided, could result in death or serious injury.



Caution

Caution indicates a hazard with a low level of risk which, if not avoided, could result in minor or moderate injury.

Warning

1. The compatibility of the product is the responsibility of the person who designs the equipment or decides its specifications.

Since the product specified here is used under various operating conditions, its compatibility with specific equipment must be decided by the person who designs the equipment or decides its specifications based on necessary analysis and test results. The expected performance and safety assurance of the equipment will be the responsibility of the person who has determined its compatibility with the product. This person should also continuously review all specifications of the product referring to its latest catalog information, with a view to giving due consideration to any possibility of equipment failure when configuring the equipment.

2. Only personnel with appropriate training should operate machinery and equipment.

The product specified here may become unsafe if handled incorrectly. The assembly, operation and maintenance of machines or equipment including our products must be performed by an operator who is appropriately trained and experienced.

3. Do not service or attempt to remove product and machinery/equipment until safety is confirmed.

1. The inspection and maintenance of machinery/equipment should only be performed after measures to prevent falling or runaway of the driven objects have been confirmed.
2. When the product is to be removed, confirm that the safety measures as mentioned above are implemented and the power from any appropriate source is cut, and read and understand the specific product precautions of all relevant products carefully.
3. Before machinery/equipment is restarted, take measures to prevent unexpected operation and malfunction.

4. Our products cannot be used beyond their specifications. Our products are not developed, designed, and manufactured to be used under the following conditions or environments. Use under such conditions or environments is not covered.

1. Conditions and environments outside of the given specifications, or use outdoors or in a place exposed to direct sunlight.
2. Use for nuclear power, railways, aviation, space equipment, ships, vehicles, military application, equipment affecting human life, body, and property, fuel equipment, entertainment equipment, emergency shut-off circuits, press clutches, brake circuits, safety equipment, etc., and use for applications that do not conform to standard specifications such as catalogs and operation manuals.
3. Use for interlock circuits, except for use with double interlock such as installing a mechanical protection function in case of failure. Please periodically inspect the product to confirm that the product is operating properly.



Safety Instructions

Caution

We develop, design, and manufacture our products to be used for automatic control equipment, and provide them for peaceful use in manufacturing industries.

Use in non-manufacturing industries is not covered.

Products we manufacture and sell cannot be used for the purpose of transactions or certification specified in the Measurement Act.

The new Measurement Act prohibits use of any unit other than SI units in Japan.

Limited warranty and Disclaimer/Compliance Requirements

The product used is subject to the following "Limited warranty and Disclaimer" and "Compliance Requirements".

Read and accept them before using the product.

Limited warranty and Disclaimer

1. The warranty period of the product is 1 year in service or 1.5 years after the product is delivered, whichever is first.*2)

Also, the product may have specified durability, running distance or replacement parts. Please consult your nearest sales branch.

2. For any failure or damage reported within the warranty period which is clearly our responsibility, a replacement product or necessary parts will be provided.

This limited warranty applies only to our product independently, and not to any other damage incurred due to the failure of the product.

3. Prior to using SMC products, please read and understand the warranty terms and disclaimers noted in the specified catalog for the particular products.

***2) Vacuum pads are excluded from this 1 year warranty.**

A vacuum pad is a consumable part, so it is warranted for a year after it is delivered.

Also, even within the warranty period, the wear of a product due to the use of the vacuum pad or failure due to the deterioration of rubber material are not covered by the limited warranty

Compliance Requirements

1. The use of SMC products with production equipment for the manufacture of weapons of mass destruction (WMD) or any other weapon is strictly prohibited.

2. The exports of SMC products or technology from one country to another are governed by the relevant security laws and regulations of the countries involved in the transaction. Prior to the shipment of a SMC product to another country, assure that all local rules governing that export are known and followed.

Operator

- ◆ This operation manual is intended for those who have knowledge of machinery using pneumatic equipment, and have sufficient knowledge of assembly, operation and maintenance of such equipment. Only those persons are allowed to perform assembly, operation and maintenance.
- ◆ Read and understand this operation manual carefully before assembling, operating or providing maintenance to the product.

■ Safety Instructions

Warning

- Do not disassemble, modify (including changing the printed circuit board) or repair.
An injury or failure can result.
- Do not operate or set with wet hands.
This may lead to an electric shock.
- Do not operate the product outside of the specifications.
Do not use for flammable or harmful fluids.
Fire, malfunction, or damage to the product can result.
Verify the specifications before use.
- Do not operate in an atmosphere containing flammable or explosive gases.
Fire or an explosion can result.
This product is not designed to be explosion proof.
- If using the product in an interlocking circuit:
 - Provide a double interlocking system, for example a mechanical system.
 - Check the product regularly for proper operation.
 Otherwise malfunction can result, causing an accident.
- The following instructions must be followed during maintenance:
 - Turn off the power supply.
 - Stop the air supply, exhaust the residual pressure and verify that the air is released before performing maintenance.
 Otherwise an injury can result.

Caution

- When handling the unit or assembling/replacing units:
 - Do not touch the sharp metal parts of the connector or plug for connecting units.
 - Take care not to hit your hand when disassembling the unit.
The connecting portions of the unit are firmly joined with seals.
 - When joining units, take care not to get fingers caught between units.
An injury can result.

- After maintenance is complete, perform appropriate functional inspections.
Stop operation if the equipment does not function properly.
Safety cannot be assured in the case of unexpected malfunction.

- Provide grounding to assure noise resistance of the Fieldbus system.
Individual grounding should be provided close to the product with a short cable.

Precautions regarding the Radio Law

This equipment has been tested and found to comply with the limits for a Class B digital device, pursuant to part 15 of the FCC Rules. These limits are designed to provide reasonable protection against harmful interference in a residential installation. This equipment generates, uses and can radiate radio frequency energy and, if not installed and used in accordance with the instructions, may cause harmful interference to radio communications. However, there is no guarantee that interference will not occur in a particular installation. If this equipment does cause harmful interference to radio or television reception, which can be determined by turning the equipment off and on, the user is encouraged to try to correct the interference by one or more of the following measures:

- Reorient or relocate the receiving antenna.
- Increase the separation between the equipment and receiver.
- Connect the equipment into an outlet on a circuit different from that to which the receiver is connected.
- Consult the dealer or an experienced radio/TV technician for help.



Caution

Any changes or modifications not expressly approved by the grantee of this device could void the user's authority to operate the equipment.

This device complies with part 15 of the FCC Rules. Operation is subject to the following two conditions:

- (1) this device may not cause harmful interference, and
- (2) this device must accept any interference received, including interference that may cause undesired operation.

This device complies with Industry Canada's licence-exempt RSSs. Operation is subject to the following two conditions:

- (1) This device may not cause interference; and
- (2) This device must accept any interference, including interference that may cause undesired operation of the device.

Le présent appareil est conforme aux CNR d'Industrie Canada applicables aux appareils radio exempts de licence.

L'exploitation est autorisée aux deux conditions suivantes:

- (1) l'appareil ne doit pas produire de brouillage, et
- (2) l'utilisateur de l'appareil doit accepter tout brouillage radioélectrique subi, même si le brouillage est susceptible d'en compromettre le fonctionnement.



Caution

When operating this device, follow the safety requirements for radio frequency exposure established by the Federal Communications Commission (FCC) and Innovation, Science and Economic Development Canada, and keep the human body (excluding fingers, hands, wrists, ankles, and feet) at least 20 cm away from the device.

When installing this device, place it 20 cm away from the end user.

Este equipamento não tem direito à proteção contra interferência prejudicial e não pode causar interferência em sistemas devidamente autorizados. Para maiores informações, consulte o site da ANATEL – www.anatel.gov.br

ANATEL : 06513-22-14800

Made in Japan

Incorpora produto homologado pela Anatel sob número 06513-22-14800

เครื่องโทรคมนาคมและอุปกรณ์นี้มีความสอดคล้องตามมาตรฐานหรือข้อกำหนดทางเทคนิคของ กสทช.

(This telecommunication equipment conforms to the technical standards or requirements of NBTC.)

■ Precautions for Handling

○ Follow the instructions given below for selecting and handling.

- The instructions on design and selection (installation, wiring, environment, adjustment, operation, maintenance, etc.) described below must be followed.

*Product specifications

- Use within the specified voltage.
Otherwise failure or malfunction can result.
- Reserve a space for maintenance.
Design the system to allow the required space for maintenance.
- Do not remove the label.
This can lead to incorrect maintenance, or misreading of the operation manual, which can cause damage or malfunction to the product.
It may also result in nonconformity to safety standards.
- Beware of inrush current when the power supply is turned on.
An initial charge current may activate the over current protection function depending on the connected load, resulting in the unit malfunctioning.

● Product Handling

*Mounting

- Do not drop, hit or apply excessive shock to the product.
Otherwise damage to the internal parts can result, causing malfunction.
- Tighten to the specified tightening torque.
If the tightening torque is exceeded, the mounting screws can be broken.
If the screws are tightened to a different torque, IP67 will not be achieved.
- Never mount the product in a location that will be used as a foothold.
The product may be damaged if excessive force is applied by stepping or climbing onto it.

*Wiring (Including connecting/disconnecting of the connectors)

- Avoid bending or stretching the cables repeatedly, or placing a heavy load or apply force to the product.
Applying repeated bending and tensile stress to the cable may cause broken wires.
- Wire correctly.
Incorrect wiring may cause malfunction of or damage to the wireless system.
- Do not perform wiring while the power is on.
Otherwise the wireless system may be damaged or malfunction.
- Do not route wires and cables together with power or high voltage cables.
The product can malfunction due to interference of noise and surge voltage from power and high voltage cables close to the signal line.
Route the wires of the wireless system separately from power or high voltage cables.
- Confirm correct insulation of wiring.
Poor insulation (interference with other circuits, poor insulation between terminals, etc.) can apply excessive voltage or current to the wireless system causing damage to it.
- When a wireless system is installed in machinery/equipment, provide adequate protection against noise by using noise filters, etc.
Noise in signal lines may cause malfunction.

*Operating environment

- Select the correct type of enclosure according to the operating environment.
 - IP67 protection class is achieved when the following conditions are met.
 - (1) The units are connected correctly using power supply cables and communication cables with M12 (or M8) connectors.
 - (2) Suitable mounting of each unit and manifold valve.
 - (3) Be sure to fit a water resistant cap on any unused connectors.If using in an environment that is exposed to water splashes, please take protective measures, such as using a cover.
Do not use in an atmosphere having water, water steam, or where there is direct contact with any of these. These may cause failure or malfunction.
- Do not use the product in a place where the product could be splashed by oil or chemicals.
 - Operating in environments with coolants, cleaning solvents, various oils or chemicals may cause adverse effects (failure, malfunction) to the unit even in a short period of time.
- Do not use the product in an environment where corrosive gases or fluids can be splashed.
 - Otherwise damage to the unit can result, causing malfunction.
- Do not use in an area where surges are generated.
 - If there is equipment generating large surge near the unit (magnetic type lifter, high frequency inductive furnace, welding machine, motor, etc.), this can cause deterioration of the internal circuitry element of the unit or result in damage. Take measures against the surge sources, and prevent the lines from coming into close contact.
- When a surge-generating load such as a relay, valve, or lamp is directly driven, use the product with built in surge protection.
 - Direct drive of a load generating surge voltage can damage the unit.
- The product is CE/UKCA marked, but is not immune to lightning strikes. Take measures against lightning strikes in the system.
- Prevent foreign matter such as dust or wire debris from entering inside the product.
 - Otherwise it can cause damage or malfunction.
- Mount the product in a place that is not exposed to vibration or impact.
 - Otherwise it can cause damage or malfunction.
- Do not use the product in an environment that is exposed to temperature cycles.
 - Heat cycles other than ordinary changes in temperature can adversely affect the inside of the product.
- Do not expose the product to direct sunlight.
 - If using in a location directly exposed to sunlight, shade the product from the sunlight.
 - Otherwise it can cause damage or malfunction.
- Keep within the specified ambient temperature range.
 - Otherwise malfunction can result.

- Do not operate close to a heat source, or in a location exposed to radiant heat.
 - Otherwise malfunction can result.

*Adjustment and Operation

- Perform settings suitable for the operating conditions.
 - Incorrect setting can cause operation failure.
(Refer to "Setting and Adjustment".)
- Please refer to the PLC manufacturer's manual, etc. for details of PLC-side programming and addresses.
 - For the PLC protocol and programming, refer to the relevant manufacturer's documentation.

*Maintenance

- Turn off the power supply, stop the supplied air, exhaust the residual pressure and verify the release of air, before performing maintenance.

Otherwise safety is not assured due to an unexpected malfunction or incorrect operation.

- Perform regular maintenance and inspections.

There is a risk of unexpected operation due to malfunction of the equipment.

- After maintenance is complete, perform appropriate functional inspections.

Stop operation if the equipment does not function correctly.

Otherwise safety cannot be assured due to an unexpected malfunction or incorrect operation.

- Do not use solvents such as benzene, thinner, etc. to clean each unit.

These can damage the surface of the body and erase the markings on the product.

Use a soft cloth to remove stains.

For heavy stains, use a damp cloth that has been soaked with diluted neutral detergent and fully squeezed, then wipe up the stains again with a dry cloth.

Important Instructions concerning the Wireless System

- The product is certified as wireless equipment in accordance with the Radio Act and the certification of construction type has been obtained. Customers do not need to apply for a license to use this equipment.

Be sure to comply with the following precautions.

- Do not disassemble or modify the product. Disassembly and modification are prohibited by law.

- Attach and use the supplied antenna set (EXW1-EA1) as an external antenna.

The law forbids the use of antennas and coaxial cables that are not sold by SMC.

- This product is compliant with the Radio Act in Japan, European countries and the US. For the latest information, refer to the catalog on the website below.

URL <https://www.smcworld.com>

- This product communicates using radio waves, and the communication may be temporarily interrupted due to the ambient environments and operating methods. SMC will not be responsible for any secondary failure which may cause an accident or cause damage to other devices or equipment.
- When several units are installed close to each other, slight interference may occur due to the characteristics of the wireless product.
- Radio waves emitted by this product may adversely affect implantable medical devices such as implantable cardiac pacemakers and de-fibrillators.
For precautions regarding the use of equipment or devices that may adversely affect performance, refer to the catalog or instruction manuals for the equipment or devices, or contact the manufacturers directly.
- The communication performance is affected by the ambient environment, so please perform communication testing before use.

SMC Wireless System

Features and Summary

The SMC wireless system is an I/O distributed system which can be wirelessly connected. It consists of a combination of a Base that has a function to communicate with the upper-level device (such as a PLC) or a Base that has a wireless communication function and Remotes.

From an upper-level (PLC) control component, a Base appears to be a single system including Remotes paired with it, and up to 896 inputs and 896 outputs can be handled per system.

Bases and Remotes are designed to be identifiable by registering their uniquely assigned PIDs (Product IDs) with each other and operate without malfunctioning even when several Bases and Remotes operate in the same area.

The packet of the wireless transmit and receive data is encrypted. It is therefore difficult to manipulate the data.

The SMC wireless system has the following features.

- Quick start-up takes 0.25 sec. (minimum) to connect to the system when the Remote is powered. *1
- Parameter setting by Near Field Communication (NFC) using a PC (no HW setting).
- The maximum number of inputs/outputs of the system is 896/896*2, 3
- Up to 15 CC-Link Ver1.10 Remotes or 127 Ver2.00 Remotes can be registered per Base*4

*1: The Base is in start-up mode, and will change depending on the Remote power-on timing and external influences.

*2: The maximum number of inputs/outputs is 896/896. If there are more than 896 inputs or outputs, they are not recognized. There might be communication delay depending on the communication load status.

*3: Total number of Remote inputs/output registered in the Base.

*4: The maximum number of units that can be connected is 127. If 127 units is exceeded, the unit I/O will not be recognized. There might be communication delay depending on the communication load status.

System Configuration

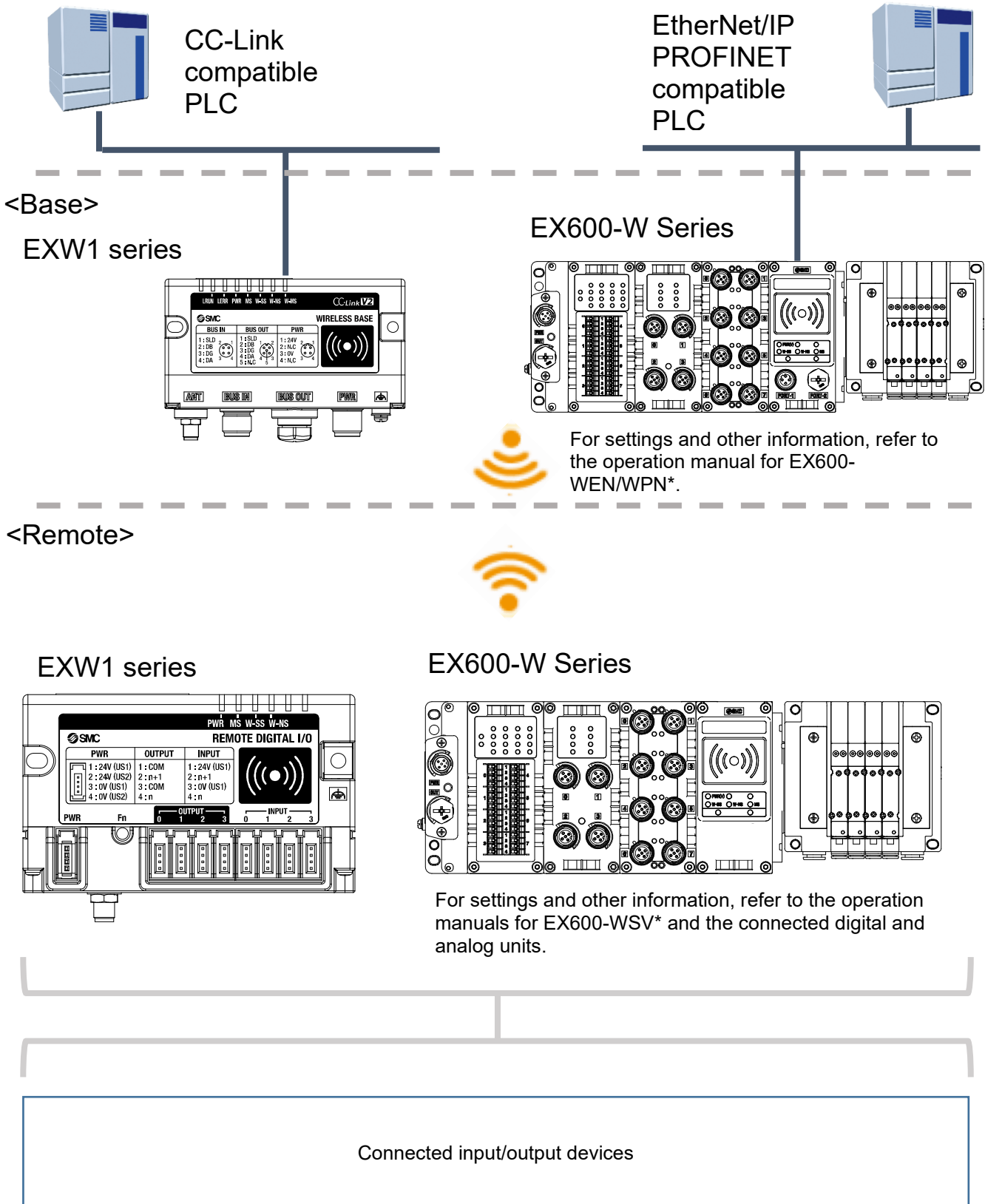

System compatibility

Mixed use with EX600-W Series

Although it is possible to use with EX600-W series, the operating conditions must comply with the specifications of the existing wireless system. Note that the following functions may be restricted:

- Communication distance
- Protocol
This refers to a wireless communication version. For more details, check the system settings of the Base.
- Frequency channel select function (F.C.S.)
The frequency channel to use can be selected using this function.
 - * The number of selectable frequency channels varies depending on the country of use.
For more details, check the product number.
 - Certified countries other than the US, Canada, Korea and Brazil: ch 5-79
 - Certified countries including the US, Canada, Korea and Brazil: ch 15-79
 - * If no channel is selected, communication is established on ch 79 by default.

Below is a conceptual diagram.

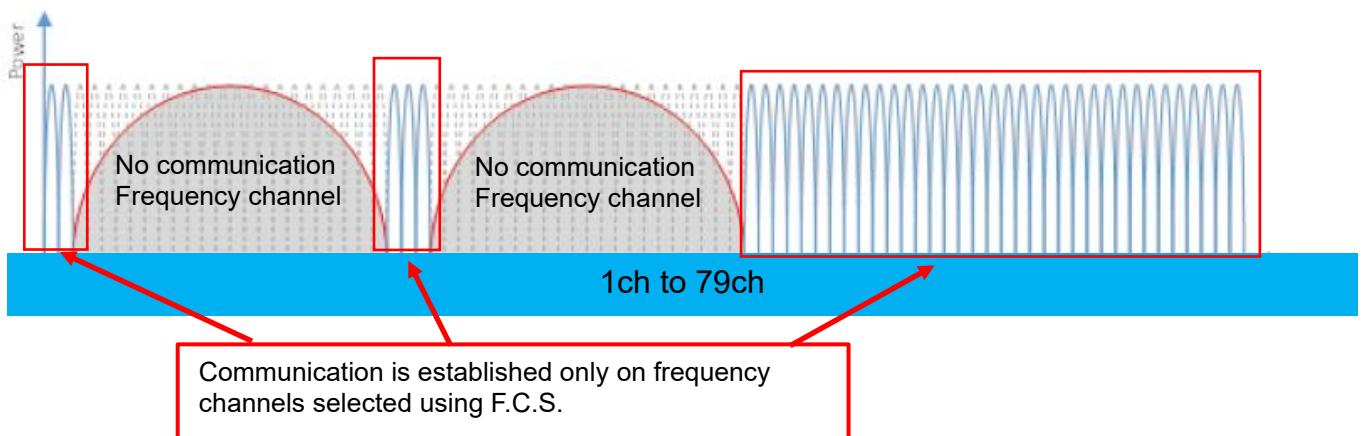

- WEB function (supported only by EX600-WEN/WPN)
Various product settings and communication statuses can be checked by accessing EX600-WEN/WPN from a PC.

Refer to the system configuration example below.

System configuration example			Applicable function			
No.	Wireless Base	Wireless Remote	Communication distance	Protocol	Frequency channel select function (F.C.S.)	WEB function
1	EXW1	EXW1	Up to 100 m	V.1.0/V.2.0 ^{*1}	Available ^{*2}	-
2	EXW1	EXW1+EX600	*3	V.1.0	NA	-
3	EXW1	EX600	Up to 10 m	V.1.0	NA	-
4	EX600	EXW1	Up to 10 m	V.1.0	NA	Available ^{*4}
5	EX600	EXW1+EX600	Up to 10 m	V.1.0	NA	Available ^{*4}
6 ^{*5}	EX600	EX600	Up to 10 m	V.1.0	NA	Available

*1: For more details, check the system settings of the Base.

*2: Available in Protocol V.2.0.

*3: Up to 100 m between an EXW1 series Base and Remote, and up to 10 m between an EXW1 series Base and an EX600-W series Remote.

4: The settings and monitor function are restricted when communication is established between EX600-WEN/WPN and EXW1-R.

*5: This configuration consists solely of EX600-W series units; refer to the operation manual for the product in use.

○ System configuration example 1

Wireless Base: EXW1-BMJA*

Wireless Remote: EXW1 series

<Wireless Base>

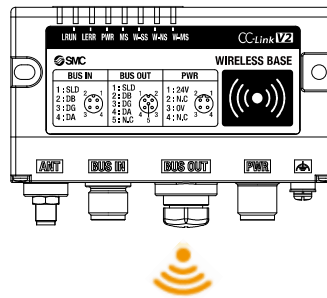

<Wireless Remote>



○ System configuration 2

Wireless Base: EXW1-BMJA*

Wireless Remote: EXW1 series, EX600-W series

<Wireless Base>

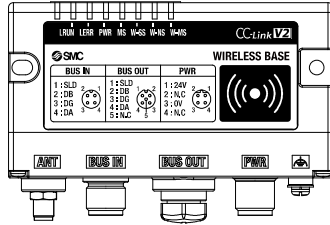

<Wireless Remote>

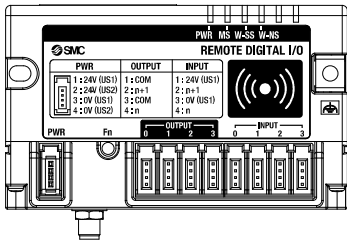

EXW1 series

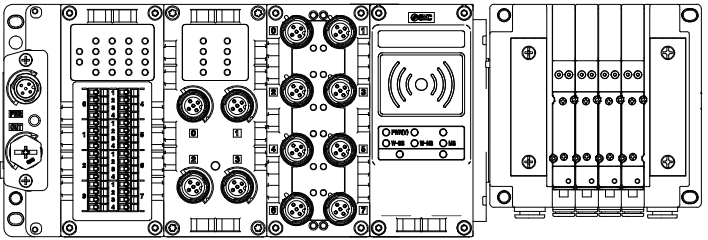

EX600-W Series

○ System configuration 3

Wireless Base: EXW1-BMJA*

Wireless Remote: EX600-W

<Wireless Base>

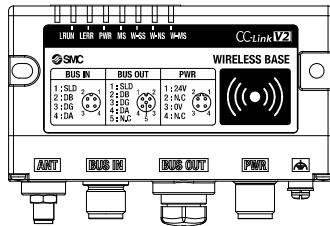

<Wireless Remote>

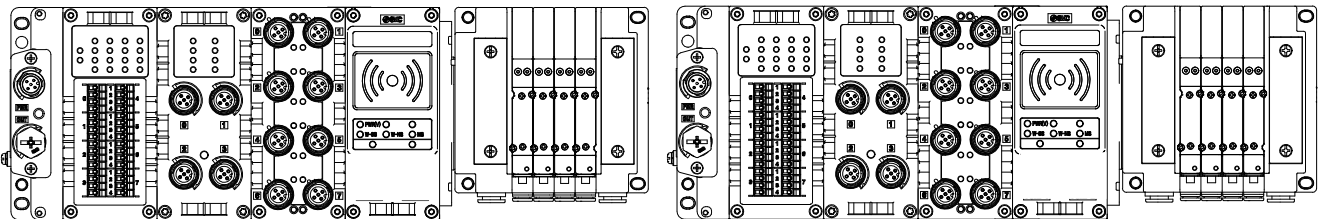

EX600-W Series

○ System configuration 4

Wireless Base: EX600-W series

Wireless Remote: EXW1 series

<Wireless Base>

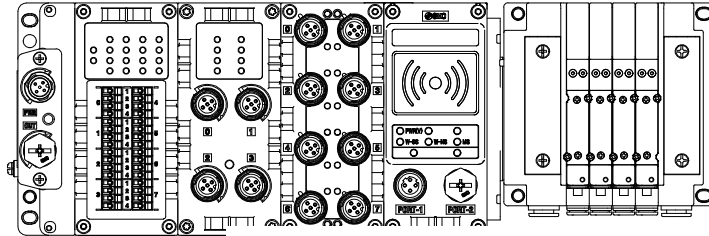

EX600-W Series



<Wireless Remote>

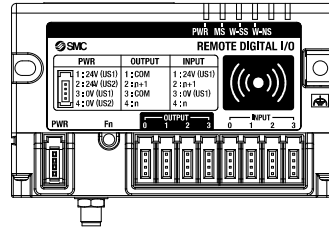
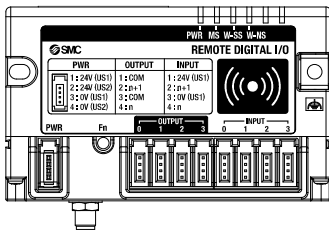

○ System configuration 5

Wireless Base: EX600-W series

Wireless Remote: EXW1 series, EX600-W series

<Wireless Base>

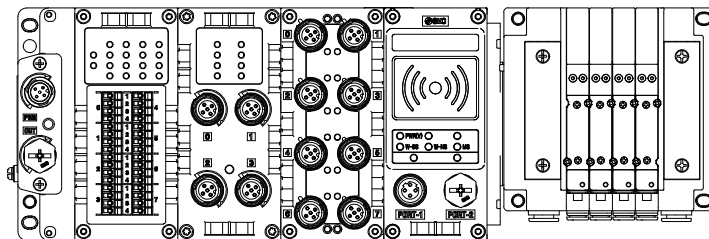

EX600-W Series



<Wireless Remote>

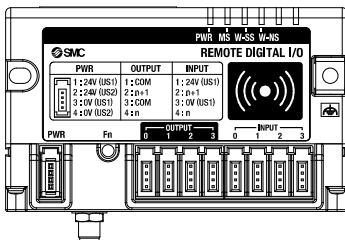

EXW1 series

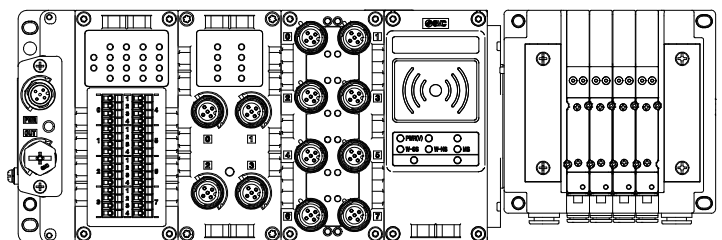

EX600-W Series

o System configuration 6

- Wireless Base: EX600-W series
- Wireless Remote: EX600-W series

For system configurations of EX600-W series, refer to the operation manual for the product in use.

How to Order

The product system, model names and part numbering system of SMC wireless systems are as follows.

<Compact wireless Base>

This product line-up consists of four models, namely EXW1-BMJAAE, EXW1-BMJAAE, EXW1-BMJABE and EXW1-BMJABN.

<Compact wireless Remotes>

This product line-up consists of 24 models, namely EXW1-RDXPE4AE, EXW1-RDXPE4AN, EXW1-RDXPE4BE, EXW1-RDXPE4BN, EXW1-RDXNE4AE, EXW1-RDXNE4AN, EXW1-RDXNE4BE, EXW1-RDXNE4BN, EXW1-RDYPE4AE, EXW1-RDYPE4AN, EXW1-RDYPE4BE, EXW1-RDYPE4BN, EXW1-RDYNE4AE, EXW1-RDYNE4AN, EXW1-RDYNE4BE, EXW1-RDYNE4BN, EXW1-RDMPE3AE, EXW1-RDMPE3AN, EXW1-RDMPE3BE, EXW1-RDMPE3BN, EXW1-RDMNE3AE, EXW1-RDMNE3AN, EXW1-RDMNE3BE and EXW1-RDMNE3BN.

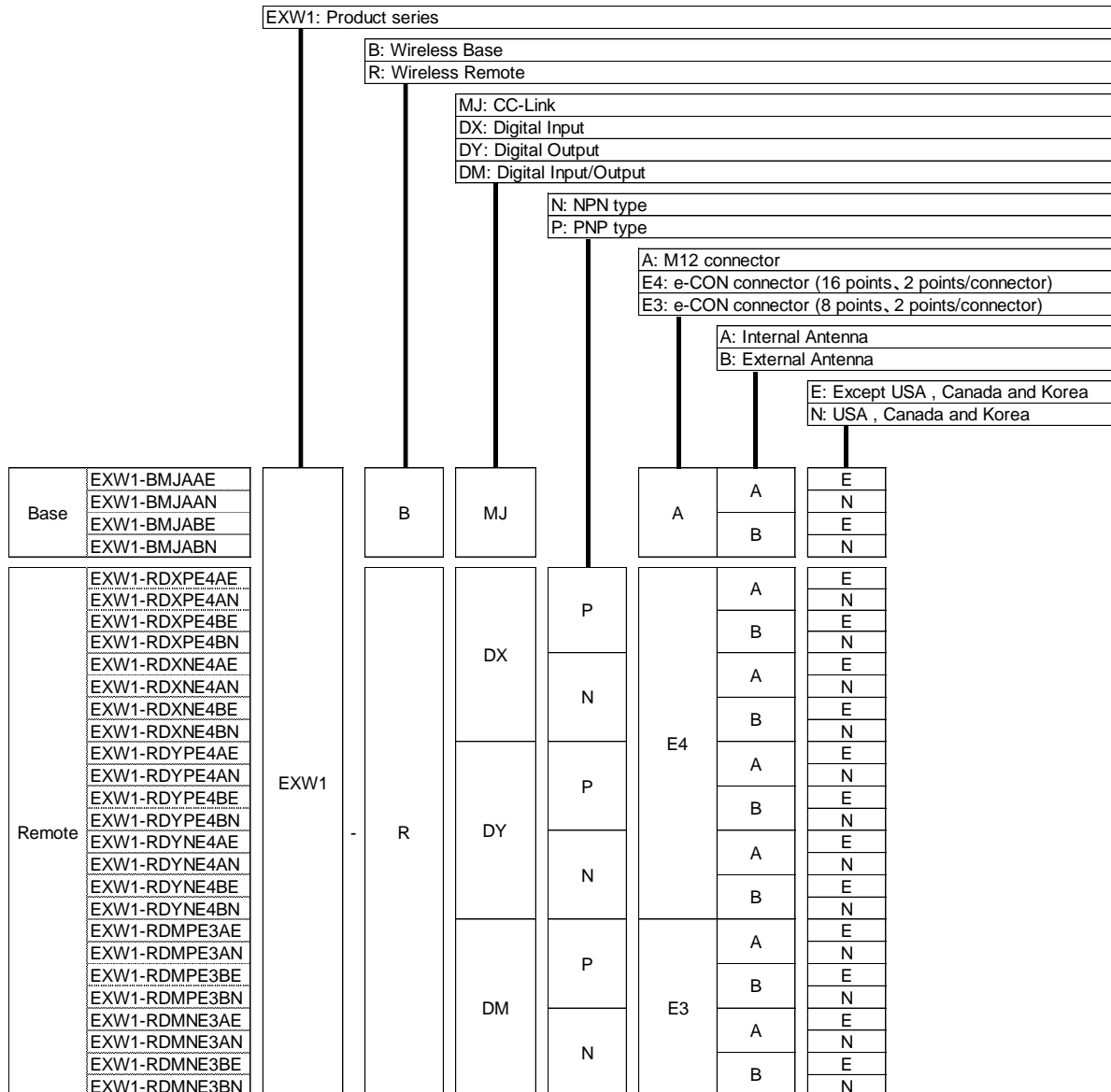

Summary of Product parts

EXW1-BMJA*

Appearance

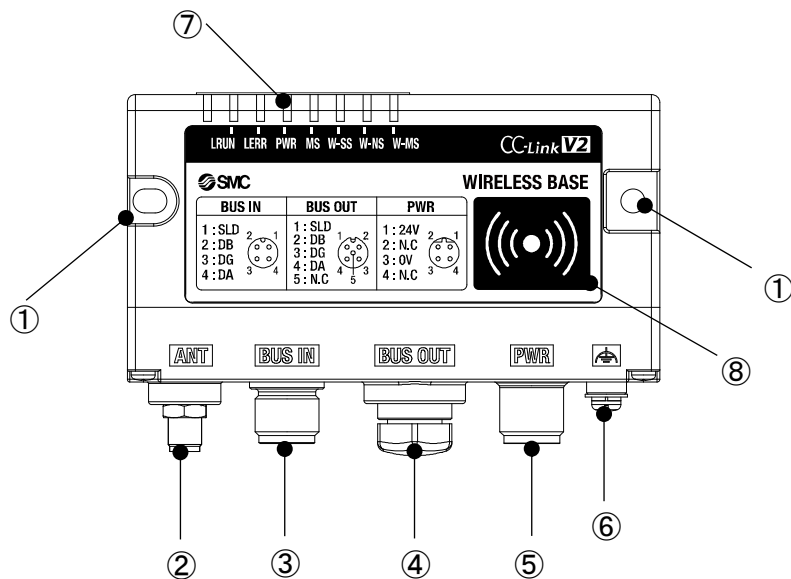

No.	Name	Application
1	Screw hole for mounting (2 x M4)	Mounting the compact wireless Base.
2	RF (SMA coaxial connector) * Exclusive to external antenna versions	Connector for the coaxial cable of an external antenna.
3	BUS IN connector	Connector for a CC-Link communication device.
4	BUS OUT connector	Connector for an additional CC-Link communication device. * Or it is connected with a terminal resistor.
5	Power supply connector	Supplies power to the compact wireless Base.
6	FE terminal	To be connected to Ground (for improved noise immunity).
7	LED	Indicates the status of the compact wireless Base or Remote.
8	NFC antenna approach area	This area is in close contact with the NFC reader / writer. "o" is the center of the NFC antenna.

* Grounding should be as close as possible to the product and the grounding wire should be as short as possible.

LED

The LED indicators at the top left corner of the compact wireless Base indicate the power supply, communication and diagnostic status.

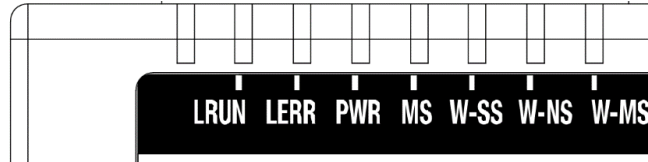

LED indicators of the compact wireless Base

LED name	Function	LED status		Description
		Colour of LED	ON/Flashing	
LRUN	Data link status indication	Green	ON	Communication is normal
		-	OFF	Communication is not established or the US1 (for control) power supply is OFF
LERR	Error status indication	Red	ON	A communication error has occurred
		-	OFF	No communication error
PWR	US1 (for control) power supply status indication	Green	ON	The US1 (for control) power supply is ON
		-	OFF	The US1 (for control) power supply is OFF
MS	Base system status indication	Green	ON	The compact wireless Base is operating normally
		Red	Flashing	Recoverable error is detected. (LED flashes when more than one diagnostic information item is detected.) •US1 (for control) power supply voltage level is abnormal •Number of system inputs/outputs setting error •Network setting error •Abnormal number of registered Remotes
		Red	ON	Unrecoverable error is detected.
		-	OFF	The US1 (for control) power supply is OFF
W-SS	Radio wave receiving intensity	Green	ON	The level of received radio wave power of all the connected Remotes is 3
		Green	Flashing (1 Hz)	The level of received radio wave power of some connected Remotes is 2
		Green	Flashing (2 Hz)	The level of received radio wave power of some connected Remotes is 1
		Red	Flashing	All the Remotes that support protocol V.1.0 are not connected
		Orange	Flashing	All the Remotes that support protocol V.2.0 are not connected
		-	OFF	Remote not registered
W-NS	Wireless communication connection status indication	Green	ON	All the Remote connections are normal
		Green	Flashing	Some Remotes are not connected
		Red	Flashing	No Remotes are connected
		Red	ON	No Remotes are connected (Unrecoverable error in wireless communication)
		Red Green	Alternate Flashing	Wireless communication connection is being configured (Pairing)
		-	OFF	Remote not registered
W-MS	Remote system status indication	Green	ON	Wireless Remote is normal
		Red	Flashing	Recoverable error is detected. (LED flashes when more than one diagnostic information item is detected.) •US1 (for control / input) power supply voltage level is abnormal •US2 (for output) power supply voltage level is abnormal •Excessive I/O setting inputs/outputs •Analog I/O upper setting limit exceeded •Analog input range upper and lower limits exceeded •Error in communication between units •EX600 I/O unit detects diagnostic information •Valve diagnostic information detected
		Red	ON	Unrecoverable error is detected.
		-	OFF	Remote not registered

Connectors

Power supply connector

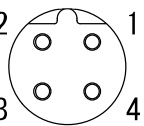
No.	Signal	M12, 4-pin, plug
		B code
1	24V (US1)	
2	N.C.	
3	0V (US1)	
4	N.C.	

Caution

Note that connecting the power cable to BUS IN or BUS OUT will damage the product.

BUS IN / BUS OUT connectors

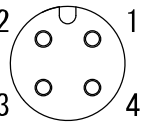
No.	BUS IN	
	Signal	M12, 4-pin, plug
		A code
1	SLD	
2	DB	
3	DG	
4	DA	

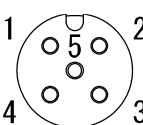
No.	BUS OUT	
	Signal	M12, 5-pin, socket
		A code
1	SLD	
2	DB	
3	DG	
4	DA	
5	N.C.	

The signal line of this product is T-branched inside the Base as shown in the circuit diagram below. When expanding the system, an additional CC-Link remote device can be connected to BUS OUT.

Circuit diagram

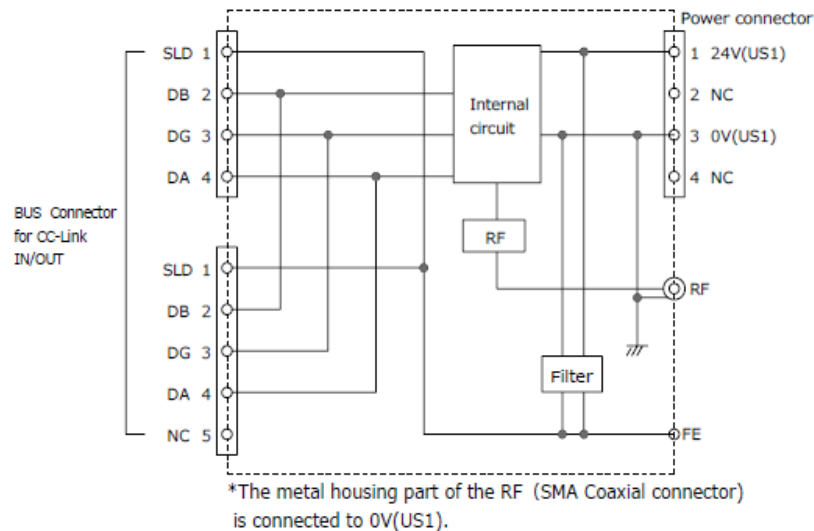

Precautions for Handling

Be sure to connect terminal resistors to both ends of the CC-Link main line.

Type of cable	Resistance value	Terminating resistor model no. (Manufacturer)
Communication cable for CC-Link PCA-1567720 (socket) PCA-1567717 (plug)	110Ω 1/2 W	•VA-4DCC-110 (Correns) •CC100 (Woodhead Japan)
CC-Link dedicated high-performance cable	130 Ω 1/2 W	•VA-4DCC-130 (Correns)

EXW1-RD*

Appearance

EXW1-RDX*B*

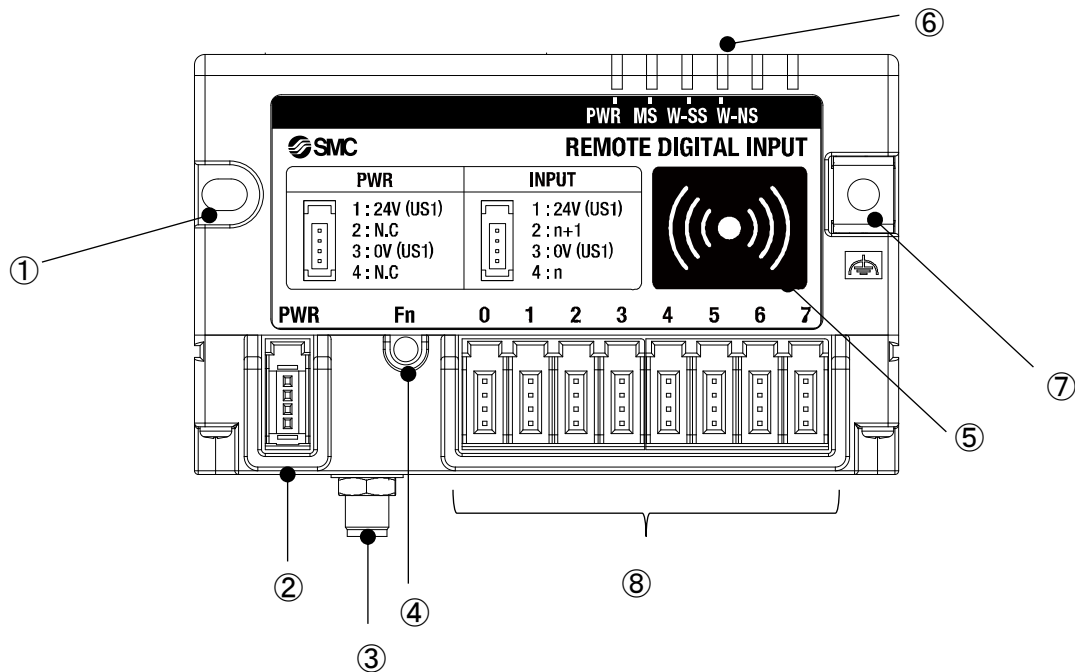

No.	Name	Application
1	Screw hole for mounting (M4)	Mounting the compact wireless Remote.
2	PWR (Power connector)	Supplies power to the compact wireless Remote.
3	RF (SMA coaxial connector) * Exclusive to external antenna versions	Connector for the coaxial cable of an external antenna.
4	Fn (Pairing button)	Press the button when switching to pairing mode.
5	NFC antenna approach area	This area is in close contact with the NFC reader / writer. "o" is the center of the NFC antenna.
6	LED	Indicates the status of the compact wireless Remote.
7	FE terminal, screw hole for mounting (M4)	To be connected to Ground (for improved noise immunity). This doubles as a screw hole for mounting.
8	Connector for an input device x 8	Connector for an input device. (PIN2, PIN4: input)

EXW1-RDY*B*

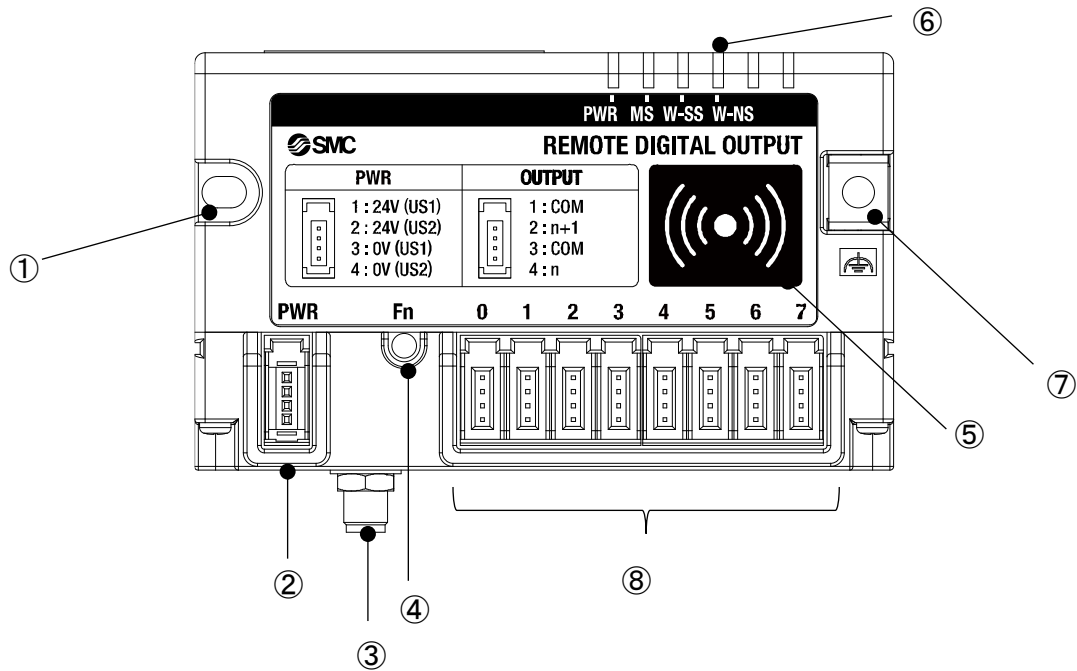

No.	Name	Application
1	Screw hole for mounting (M4)	Mounting the compact wireless Remote.
2	PWR (Power connector)	Supplies power to the compact wireless Remote.
3	RF (SMA coaxial connector) * Exclusive to external antenna versions	Connector for the coaxial cable of an external antenna.
4	Fn (Pairing button)	Press the button when switching to pairing mode.
5	NFC antenna approach area	This area is in close contact with the NFC reader / writer. "o" is the center of the NFC antenna.
6	LED	Indicates the status of the compact wireless Remote.
7	FE terminal, screw hole for mounting (M4)	To be connected to Ground (for improved noise immunity). This doubles as a screw hole for mounting
8	Connector for an output device x 8	Connector for an output device. (PIN2, PIN4: output)

EXW1-RDM*B*

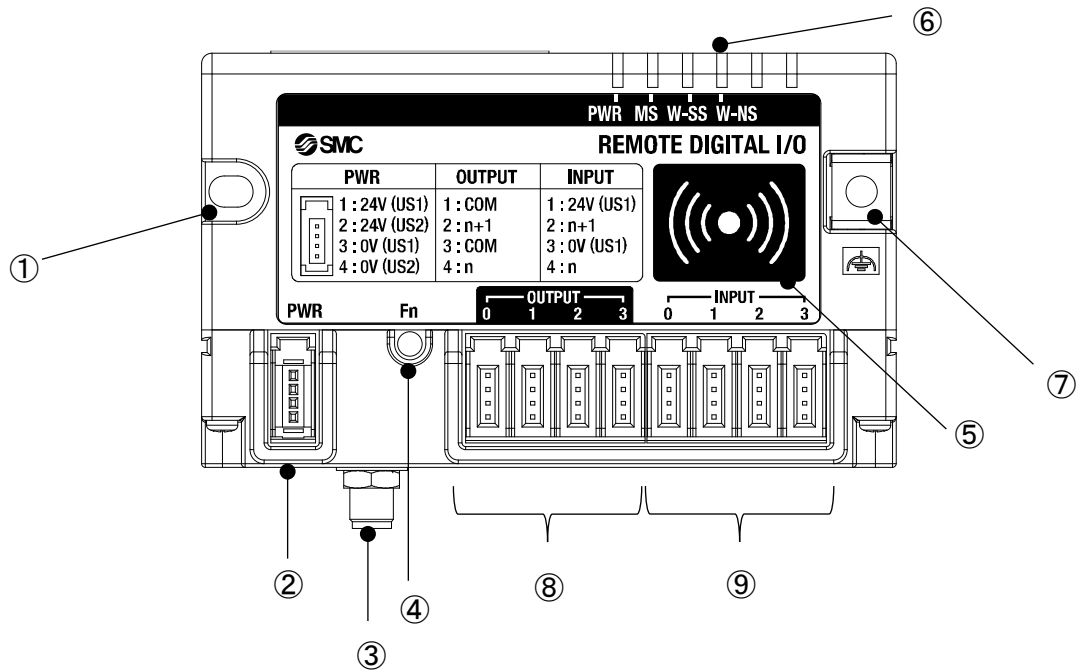

No.	Name	Application
1	Screw hole for mounting (M4)	Mounting the compact wireless Remote.
2	PWR (Power connector)	Supplies power to the compact wireless Remote.
3	RF (SMA coaxial connector) * Exclusive to external antenna versions	Connector for the coaxial cable of an external antenna.
4	Fn (Pairing button)	Pressed when switching to pairing mode.
5	NFC antenna approach area	This area is in close contact with the NFC reader / writer. "o" is the center of the NFC antenna.
6	LED	Indicates the status of the compact wireless Remote.
7	FE terminal, screw hole for mounting (M4)	To be connected to Ground (for improved noise immunity). This doubles as a screw hole for mounting.
8	Connector for an output device x 4	Connector for an output device. (PIN2, PIN4: output)
9	Connector for an input device x 4	Connector for an input device. (PIN2, PIN4: input)

LED

○EXW1-RD*

The LED indicators at the top right corner of the compact wireless Remote indicate the power supply, communication and diagnostic status.

The same LED indications are used for the EXW1-RD*.

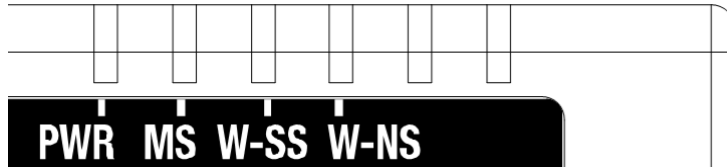

LED indicators of the compact wireless Remote

LED name	Function	LED status		Description
		Colour of LED	ON/Flashing	
PWR	Indicates the power supply voltage (US1/US2) status	Green	ON	The US1 (for control / input) power supply is ON
		Red	Flashing	US2 (for output) power supply voltage level is abnormal (when the setting is enabled)
		-	OFF	The US1 (for control / input) power supply is OFF
MS	Status of Remote	Green	ON	Operating normally
		Red	Flashing	Recoverable error is detected. (LED flashes when more than one diagnostic information item is detected.) •US1 (for control and input) power supply voltage level is abnormal (when the setting is enabled) •Short-circuit detection of the US1 (for control / input) power supply •Short-circuit detection of the US2 (for output) power supply
		Red	ON	Unrecoverable error is detected.
		-	OFF	The US1 (for control / input) power supply is OFF
W-SS	Radio wave receiving intensity	Green	ON	Received radio wave intensity level 3
		Green	Flashing (1 Hz)	Received radio wave intensity level 2
		Green	Flashing (2 Hz)	Received radio wave intensity level 1
		Red	Flashing	Protocol V.1.0 wireless communication is not established
		Orange	Flashing	Protocol V.2.0 wireless communication is not established
		-	OFF	Base not registered
W-NS	Wireless communication connection status indication	Green	ON	Base connected correctly
		Red	Flashing	Base not connected
		Orange	Flashing	Pairing operation is in progress
		Red	ON	Base not connected (Unrecoverable error in wireless communication)
		Red Green	Alternate Flashing	Wireless communication connection is being configured (pairing)
		-	OFF	Base not registered The US1 (for control / input) power supply is OFF

Connector (for e-CON)

○EXW1-RDX*

PWR (power connector)

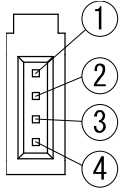

Pin number	Description
1	24V(US1)
2	N.C.
3	0V(US1)
4	N.C.

INPUT (connector for an input device)

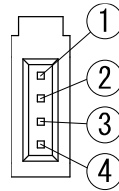

Pin number	Description
1	24V(US1)
2	n+1
3	0V(US1)
4	n

Circuit diagram

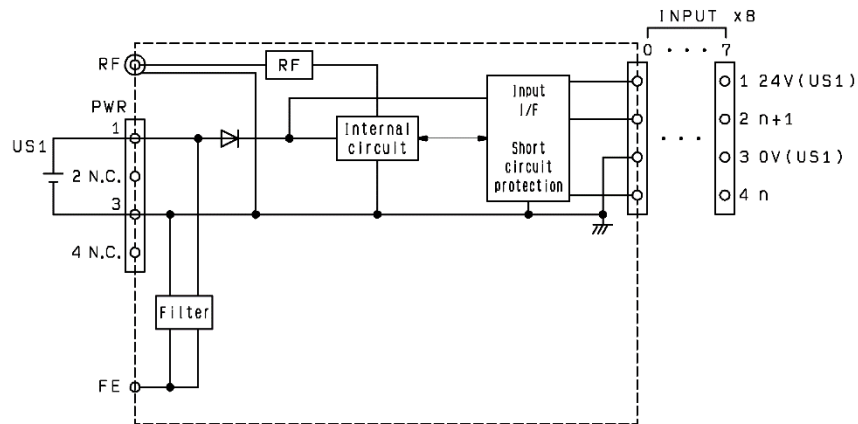

*The metal housing part of the RF(SMA Coaxial connector) is connected to 0V(US1).

○EXW1-RDY*
PWR (power connector)

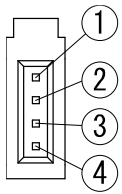

Pin number	Description
1	24V(US1)
2	24V(US2)
3	0V(US1)
4	0V(US2)

OUTPUT (connector for an output device, EXW1-RDYPE4)**

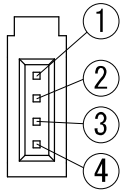

Pin number	Description
1	-COM(US2_0V)
2	n+1
3	-COM(US2_0V)
4	n

OUTPUT (connector for an output device, EXW1-RDYNE4)**

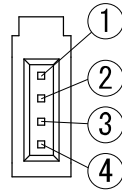

Pin number	Description
1	+COM(US2_24V)
2	n+1
3	+COM(US2_24V)
4	n

* -COM is connected to 0V (US2) and +COM to 24V (US2) inside the product as shown in the circuit diagram below.

Circuit diagram

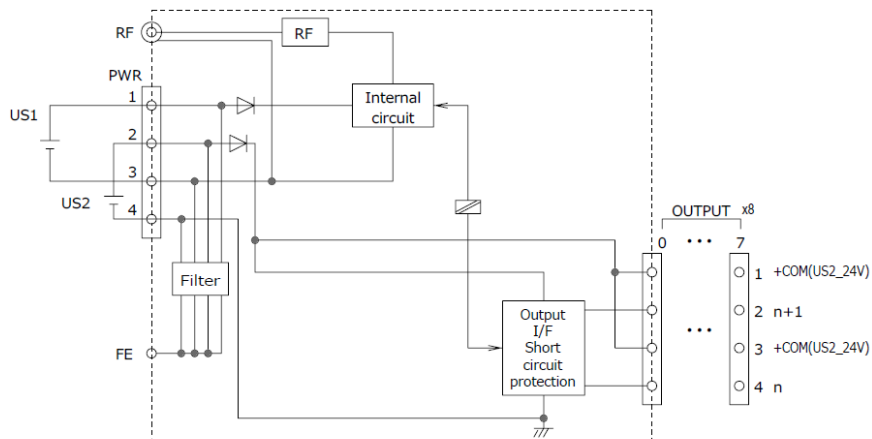

*The metal housing part of the RF (SMA Coaxial connector) is connected to 0V(US1).

○EXW1-RDM*

PWR (power connector)

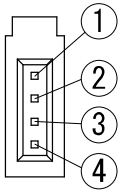

Pin number	Description
1	24V(US1)
2	24V(US2)
3	0V(US1)
4	0V(US2)

INPUT (connector for an input device)

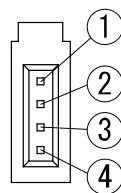

Pin number	Description
1	24V(US1)
2	n+1
3	0V(US1)
4	n

OUTPUT (connector for an output device, EXW1-RDMPE3)**

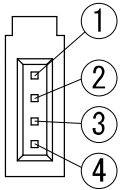

Pin number	Description
1	-COM(US2_0V)
2	n+1
3	-COM(US2_0V)
4	n

OUTPUT (connector for an output device, EXW1-RDMNE3)**

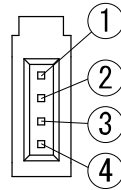

Pin number	Description
1	+COM(US2_24V)
2	n+1
3	+COM(US2_24V)
4	n

* -COM is connected to 0V (US2) and +COM to 24V (US2) inside the product as shown in the circuit diagram below.

Circuit diagram

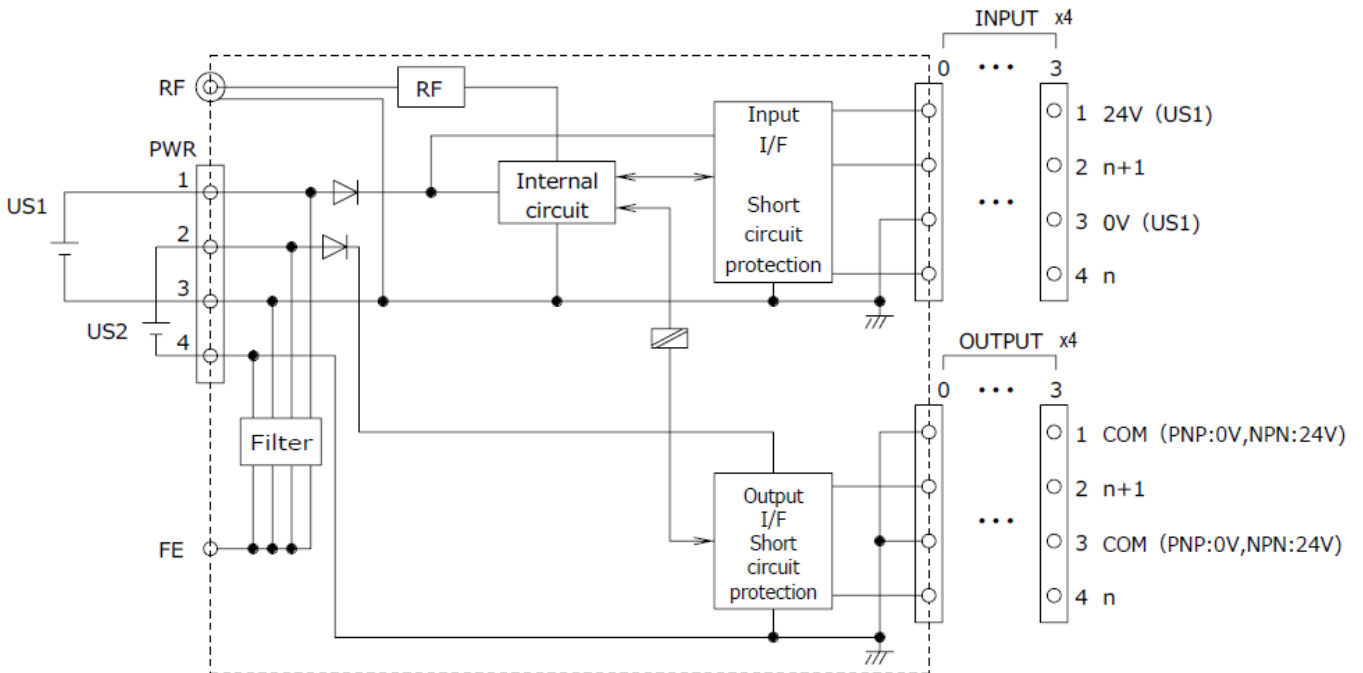

*The metal housing part of the RF (SMA Coaxial connector) is connected to 0V(US1).

Setting and Adjustment

Flow chart for operating the wireless system

Flow chart for using the wireless system

To use SMC wireless units (Base and Remotes), they need to be set up using an NFC reader/writer and the I/O Configurator. A setup procedure using NFC is shown below.

Refer to the operation manual for each manufacturer for how to set the controller and the PLC.

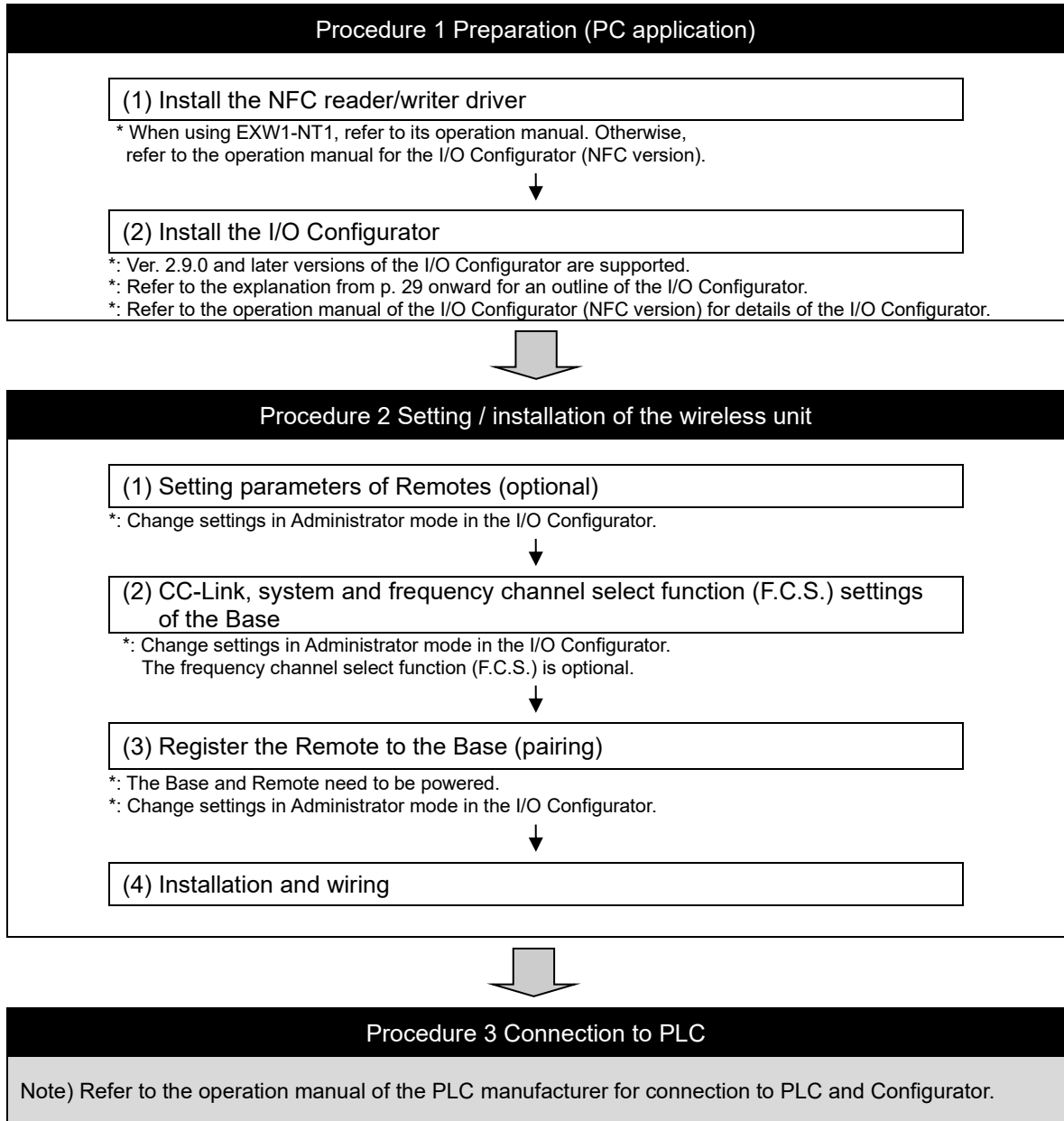

I/O Configurator (NFC version)

EXW1 series supports Ver. 2.9.0 and later versions of the I/O Configurator. In order to use the I/O Configurator (NFC version) it is necessary to install a driver etc. in advance and set the NFC reader/writer on the computer.

This section describes the installation, screen layouts and operations of the I/O Configurator (NFC version). The I/O Configurator (NFC version) can be used to check the parameter setting of the wireless unit and the contents and status of the constructed wireless system, using an NFC reader/writer and a PC.

Refer to the operation manual for the I/O Configurator (NFC version) for details of the I/O Configurator (NFC version).

■ SMC Wireless Communication System I/O Configurator (NFC version)

The I/O Configurator (NFC version) can be used to check the parameter setting of the wireless unit and the contents and status of the constructed wireless system, using an NFC reader/writer and a PC. There are two types of settable parameters which can be read or written **when no power is supplied to the product** and the parameters which can be read or written **only when power is supplied to the product**.

The figure below shows the image of connected I/O Configurator (NFC version) and wireless unit.

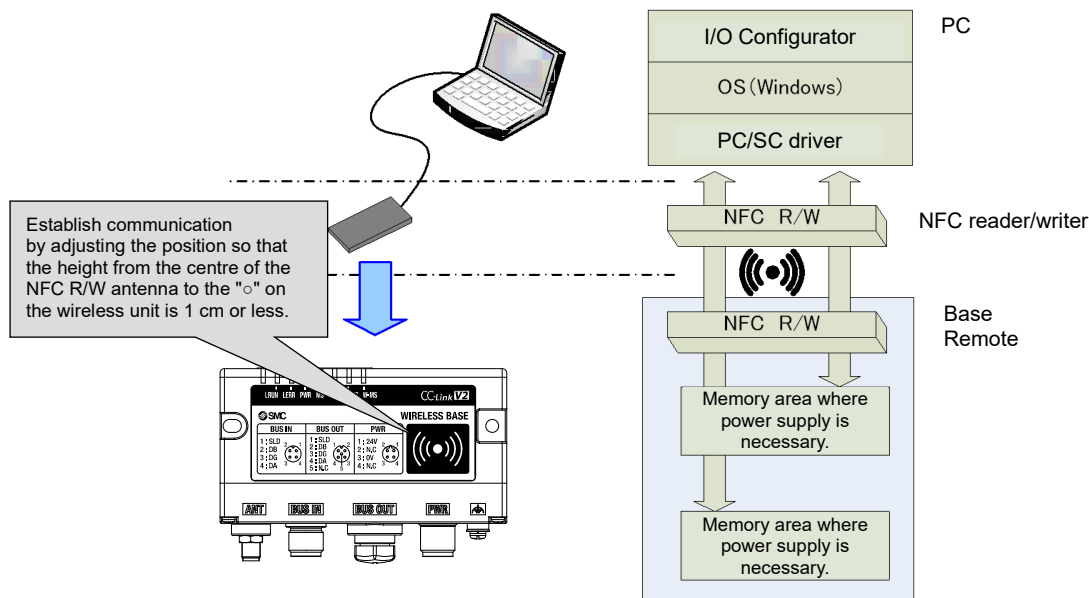

Connected I/O Configurator (NFC version) and wireless unit.



•Communication timing

The NFC communication is not accessed all the time. Therefore, **it is necessary to update the contents displayed on the screen by clicking the "Refresh button" when reading the parameters.**

The changed parameters are enabled after the product is powered on or by pressing the reset button on the I/O Configurator screen. As the parameter setting requires time for settlement, do not turn off the power supply for two seconds.

•To change the unit to be set

As the settings between the Base and Remote are different, it is necessary to update the displayed parameter by clicking the "Refresh button" on the screen of the I/O Configurator after changing the unit in which the parameters are to be set.

Preparation

Installation of the software

Driver: The following drivers should be installed before using this software.

•When EXW1-NT1 (NFC reader/writer) is used

Obtain the driver software for the NFC reader/writer from the SMC website (<https://www.smcworld.com>).

On the SMC website, select [Documents/Download] and click [Instruction Manuals].

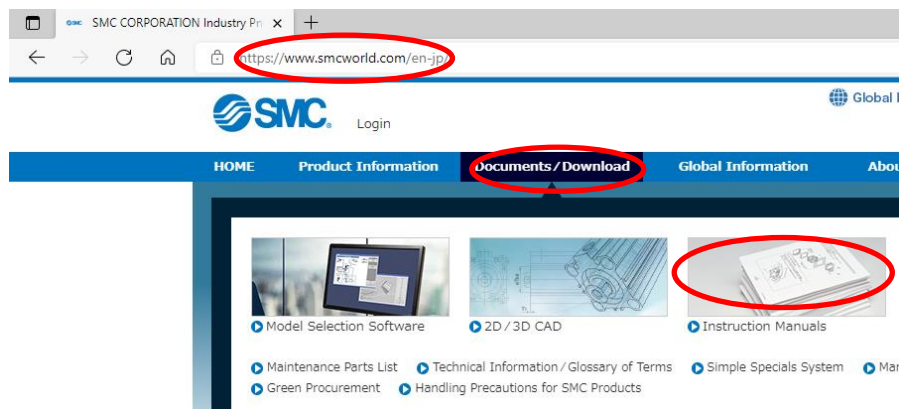

On the product search form of [Instruction Manuals], type "EXW1-NT1" to search.

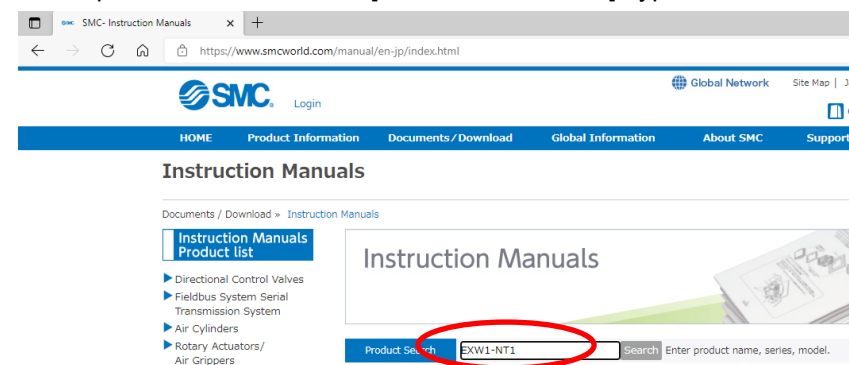

When the NFC reader / writer is held over the product, an error message may appear, such as "Device driver software was not successfully installed" or "Smart card was not identified" depending on the version of Windows OS. The reader / writer can be continuously used.

Refer to the Microsoft website (<https://support.microsoft.com/kb/976832/>).

Before starting the software

<When EXW1-NT1 is used>

Follow the steps below to install the driver software. Refer to the operation manual of EXW1-NT1 for details.

●Installation of the driver software

When the PC is connected to the Internet, the driver software is automatically installed.

Install the driver software again following the steps below.

The Windows OS starts installation of the driver by connecting the EXW1-NT1 to the USB port of the PC.

(1) Windows 8.1 / 10 displays the identified devices in the task bar at the bottom of the screen.

The icon in the red circle automatically disappears when the installation of the driver software is complete.



(2) The display below appears in the Device Manager while the EXW1-NT1 is connected to the PC and is operating correctly.

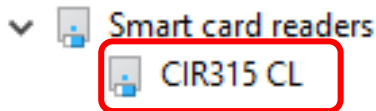

[Display of the Device Manager is incorrect]

When an exclamation mark (!) is attached to the CIR315 CL is displayed in “other device in the Device Manager”, follow the steps below.

- Right-click on the CIR315 CL, and then left-click on “driver update”.
- When the screen “start hardware update wizard ” appears, select “yes, connect only this time”, and then click “Next”.

(3) Click “automatic search for the latest driver software” for “how to search the driver software?”.

(4) When the installation does not complete successfully, take the following steps.

● Installation does not start automatically.

- (1) Download the driver software and manual referring to “Downloading of the driver software”.
- (2) Select language and press the “OK” button.

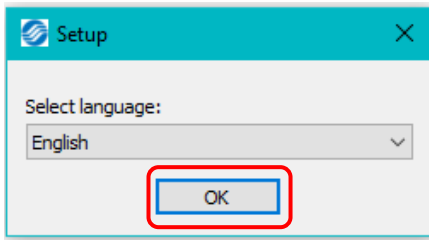

(3) Screen below appears. Press the “Next (N)” button.

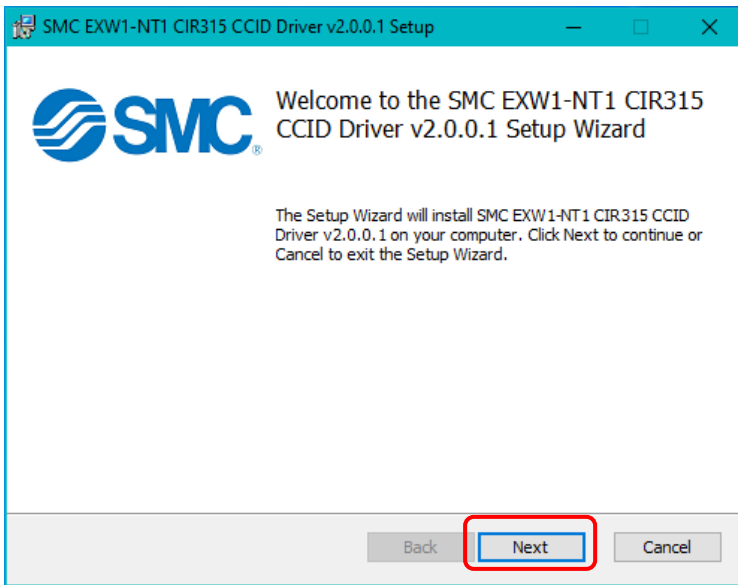

(4) Screen below appears. Press the “Next (N)” button.

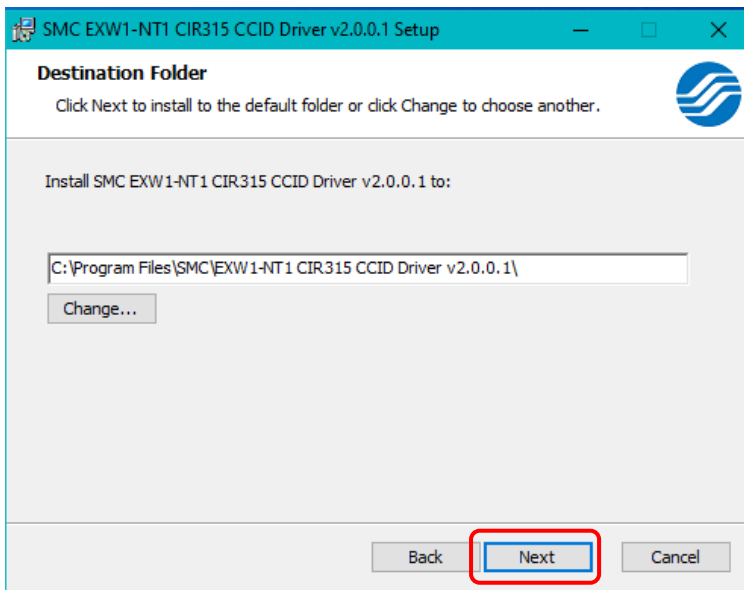

(5) Screen below appears. Press the “Install (I)” button.

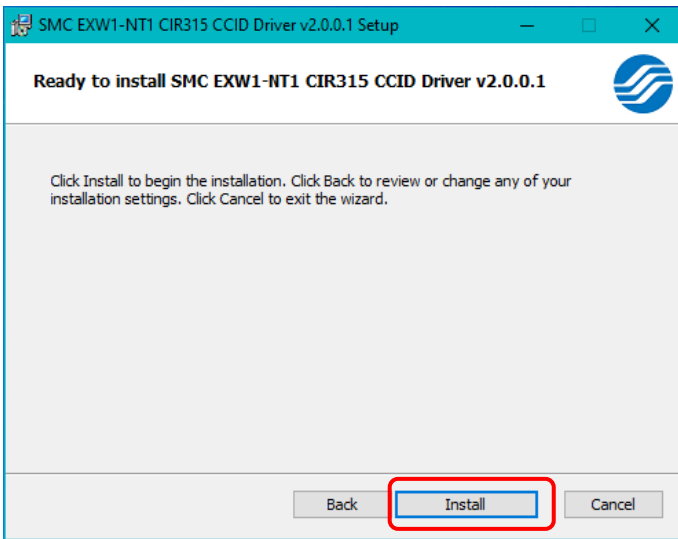

(6) The screen below appears and installation starts. Please wait.

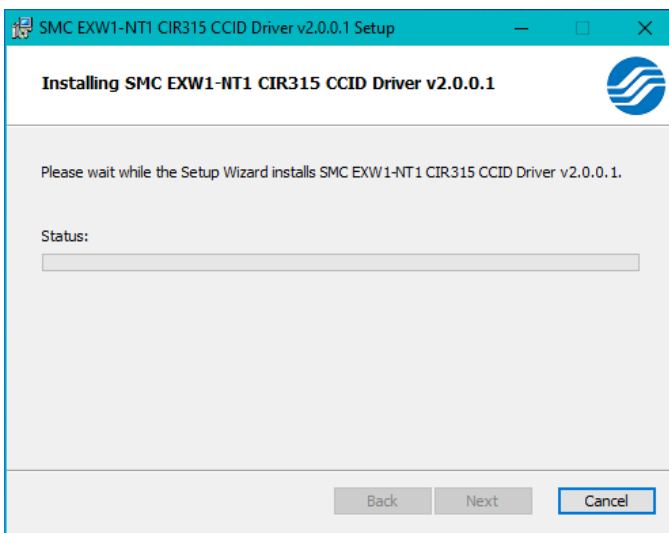

(7) The screen below appears when the installation is complete. Press the 「Finish (F)」 button.

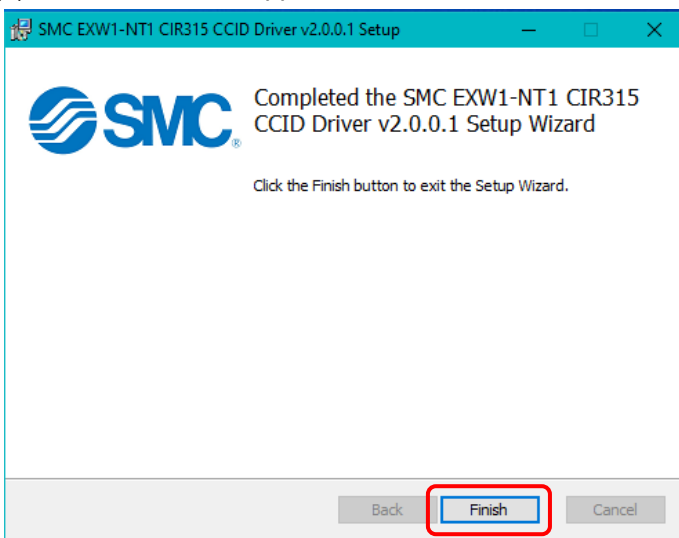

* When the screen requires restarting of the PC, restart the PC.

Download the I/O Configurator (NFC version)

(1) On the SMC website (<https://www.smcworld.com>), select [Documents/Download] and click [Instruction Manuals].

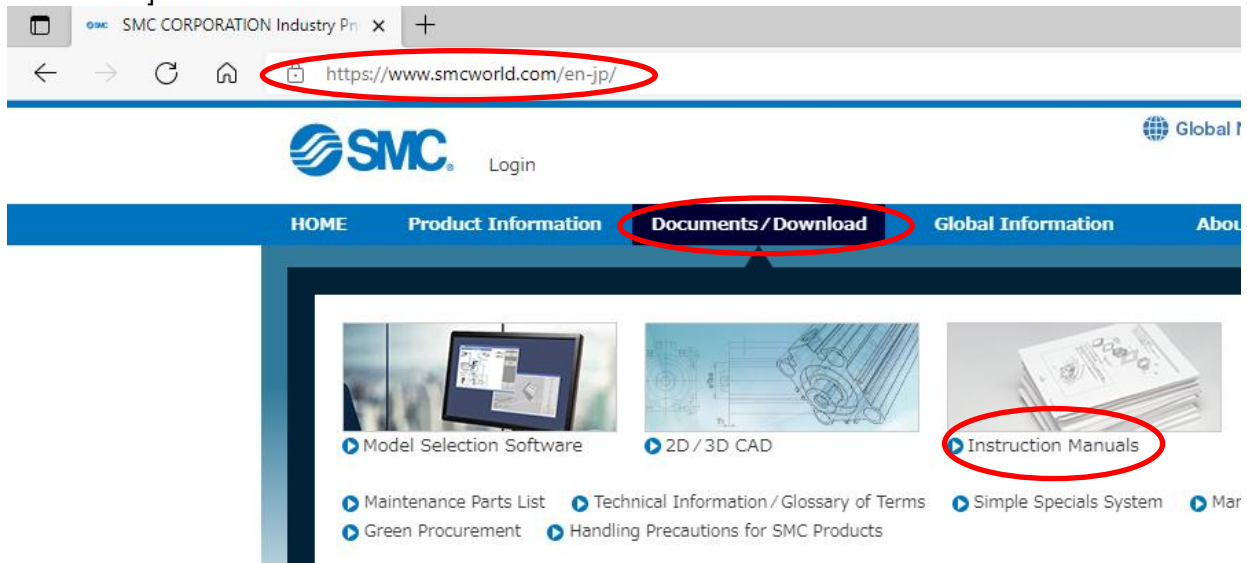

(2) Select [Fieldbus System Serial Transmission System].

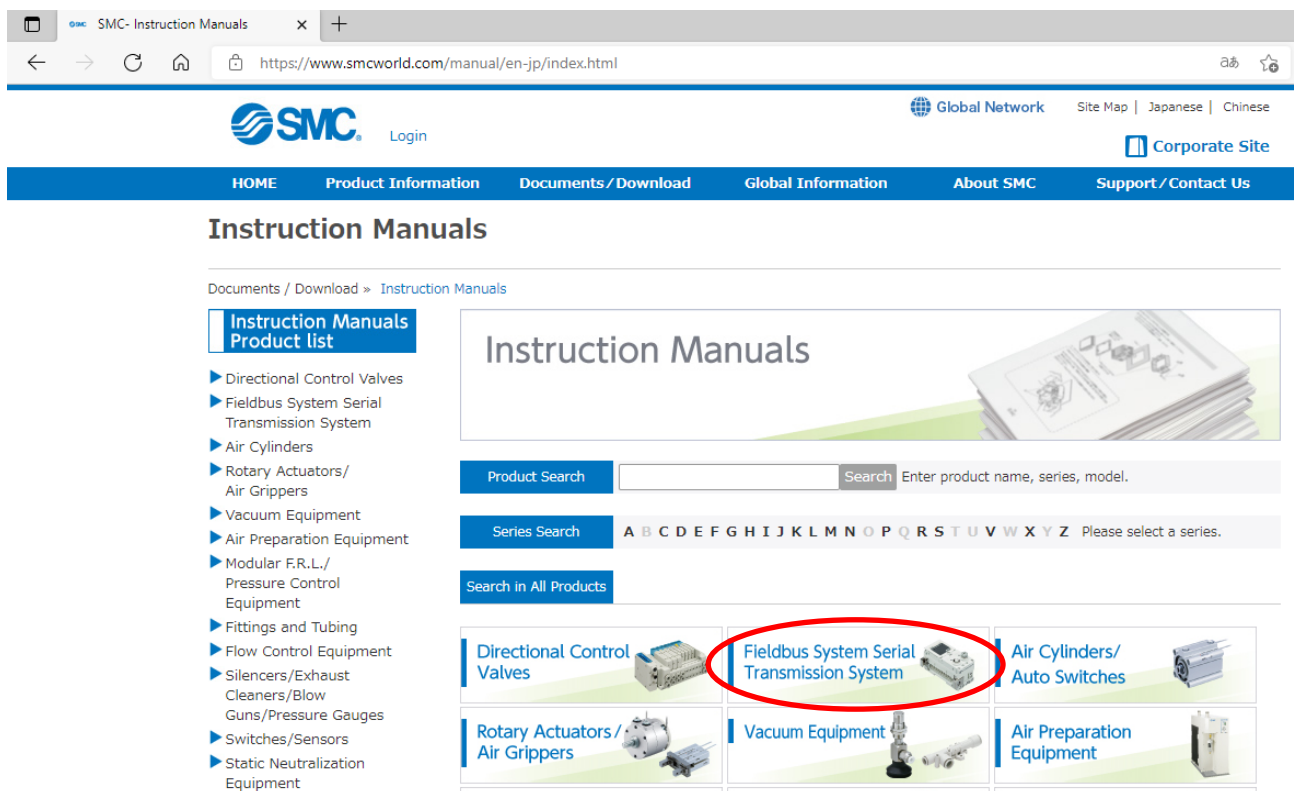

(3) Select the protocol that the product supports. (Example: "CC-Link compatible" product)

The screenshot shows the SMC website's 'Instruction Manuals' page. On the left, under 'Instruction Manuals Product list', the 'CC-Link Compatible' option is circled in red. Below this, there are search bars for 'Product Search' and 'Series Search'.

(4) Scroll down the page of the Fieldbus System Serial Transmission System and click the Configuration File of I/O Configurator for NFC. Downloading will begin.

The screenshot shows a table of products on the SMC website. The table has four columns: Product Name, Model, Configuration File, and Language. The 'Configuration File' link for the 'I/O Configurator for NFC' is circled in red.

CC-Link Compatible Compatible version : 1.10	EX510-GMJ1	Quick Guide Configuration File	
Wireless System CC-Link Compatible Compatible version : 1.10 / 2.00	EXW1-BMJ EXW1-RD # EX600-WSV	English Quick Guide Configuration File	
I/O Configurator for NFC (SMC Wireless System EX600-W/EXW1) Ver. 2.9.0	EX600-WEN EX600-WPN EX600-WSV EXW1-BMJ EXW1-RD # Initial setting application	Configuration File	Japanese, English, Chinese

Start the I/O Configurator (NFC version)

The screenshot shows a file explorer window displaying the contents of a downloaded folder. The files listed are 'ini', 'IOConfigurator.exe', and 'Sna.NoWire.dll'. The 'IOConfigurator.exe' file is circled in red.

Name	Date modified	Type	Size
ini	10/19/2021 8:05 PM	File folder	
IOConfigurator.exe	10/1/2021 8:39 AM	Application	1,216 KB
Sna.NoWire.dll	10/1/2021 8:39 AM	Application exten...	27 KB

Open the downloaded file and double click the IO Configurator.exe to start the I/O Configurator for NFC. To move IOConfigurator.exe to the desktop or another location, move the folder of the configurator, or create a shortcut of IOConfigurator.exe and invoke and use the program through it.

Screen Layouts of the I/O Configurator (NFC Version)

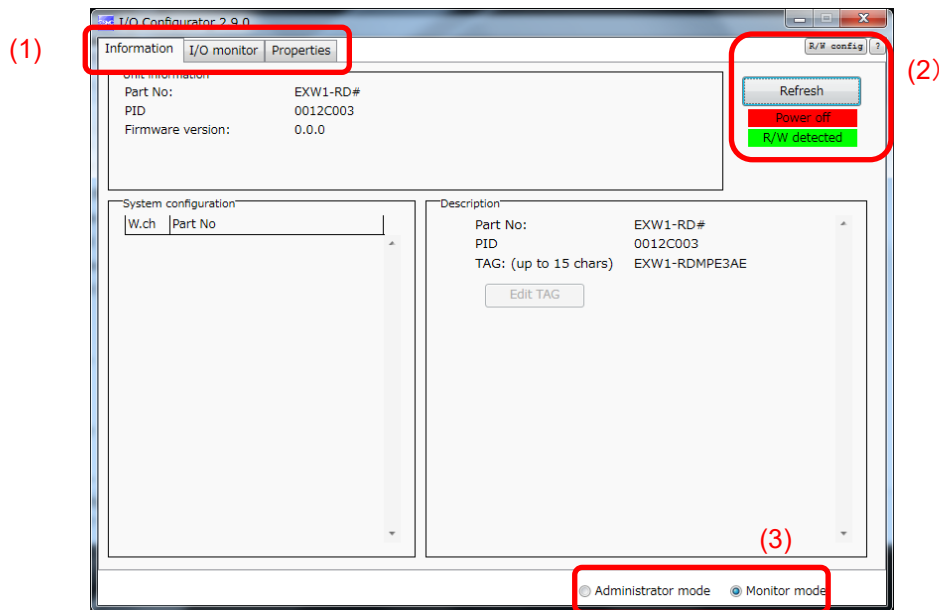

(1) Function selecting tab

I/O Configurator (NFC version) consists of three function selecting tabs.

[Information]

- Module information: Displays information on the wireless unit
- System configuration: Displays the configuration information of the Base and Remotes (connected units)
Only the system configuration of the Base is shown in tree format.
- Detailed information: Shows detailed information about the unit selected in the system configuration.

[I/O monitor]

- Input tab shows the input map information of the wireless unit.
- Output tab shows the output map information of the wireless unit.

[Properties]

- Set item: Set the parameters required to operate the Base/ Remote.

(2) Refresh, status indicators, NFC reader/writer configuration

Use these components to refresh the display of the configurator, display the power status of the module, check the connection status of the NFC reader/writer and configure the NFC reader/writer.

[Refresh]

- Clicking the refresh button while holding the NFC reader/writer to the NFC antenna approach area causes updates set in the wireless unit to be loaded. To load updates, click [Refresh].

Power status indication

- "Power supply ON" is displayed when power is supplied to the Base/Remote, and "Power supply OFF" is displayed when power is not supplied.

Connection status of the NFC reader/writer

- When the PC detects the NFC reader/writer connected to its USB port, "R/W detected" is displayed. Otherwise, "R/W not-detected" is displayed.

[R/W config] (The display may vary depending on the NFC reader/writer connected to the PC)

- When the button is clicked, the NFC reader/writer configuration screen is displayed.

(3) Mode switching button

"I/O Configurator (NFC version)" has Administrator mode and Monitor mode.

To change parameters, operate the configurator in Administrator mode.

Administrator mode: available to change the parameters

Monitor mode: available to only read the parameters (for confirmation)

To enter Administrator mode, type a password while holding the NFC reader/writer near the NFC antenna approach area and click [Confirm].

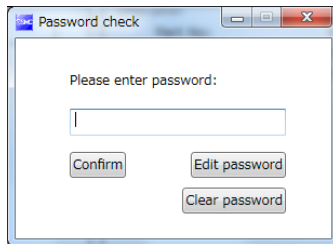

Default password: admin

If the password is forgotten, clear the password. The password will be cleared when the master factory key is entered in the [Password clear] dialog box that appears by clicking [Clear password]. Then it is possible to enter administrator mode without inputting the password.]

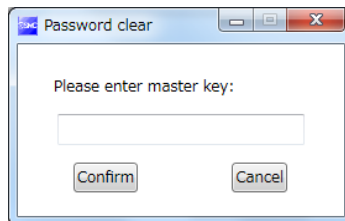

Master key: ADMIN

Any password can be set for supervisor mode. To prevent unauthorized use, it is advisable to change the default password when you first use the I/O Configurator.



- This password is not a password for the I/O Configurator (NFC version), but a password to access each unit. As such, be sure to perform a password authentication operation with an NFC reader/writer held near the NFC antenna approach area.

• **Troubleshooting**

Read error: Confirm that the NFC reader/writer is connected to the PC.

Confirm that the NFC reader/writer is held near the NFC antenna approach area.

When frozen: Remove the NFC reader/writer from the PC and connect it again.

After taking the actions above, click Refresh.

Monitoring and setting up

To change settings, switch to Administrator mode to operate the configurator.

In Administrator mode, a timeout occurs after 300 seconds of inactivity and the application returns to Monitor mode.

In Administrator mode, a timeout countdown is displayed to the right of the "Administrator mode" label.



○Operational flow during monitoring

A rough operational flow during monitoring is shown below (operations in Monitor mode).

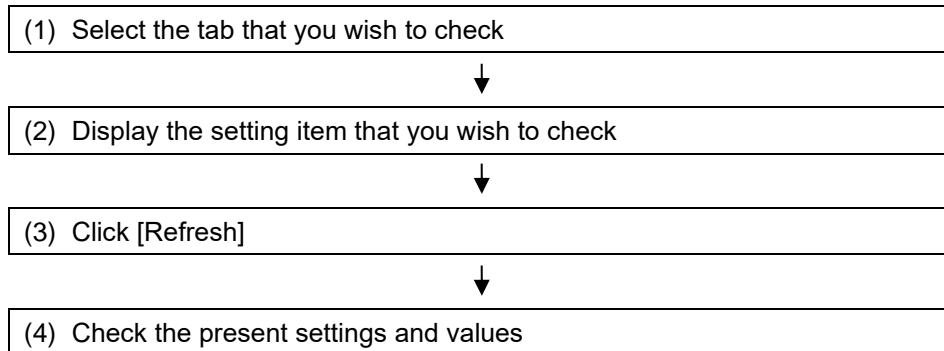

○Operational flow when changing settings

A rough operational flow during setting changing operations is shown below (operations performed in Administrator mode).

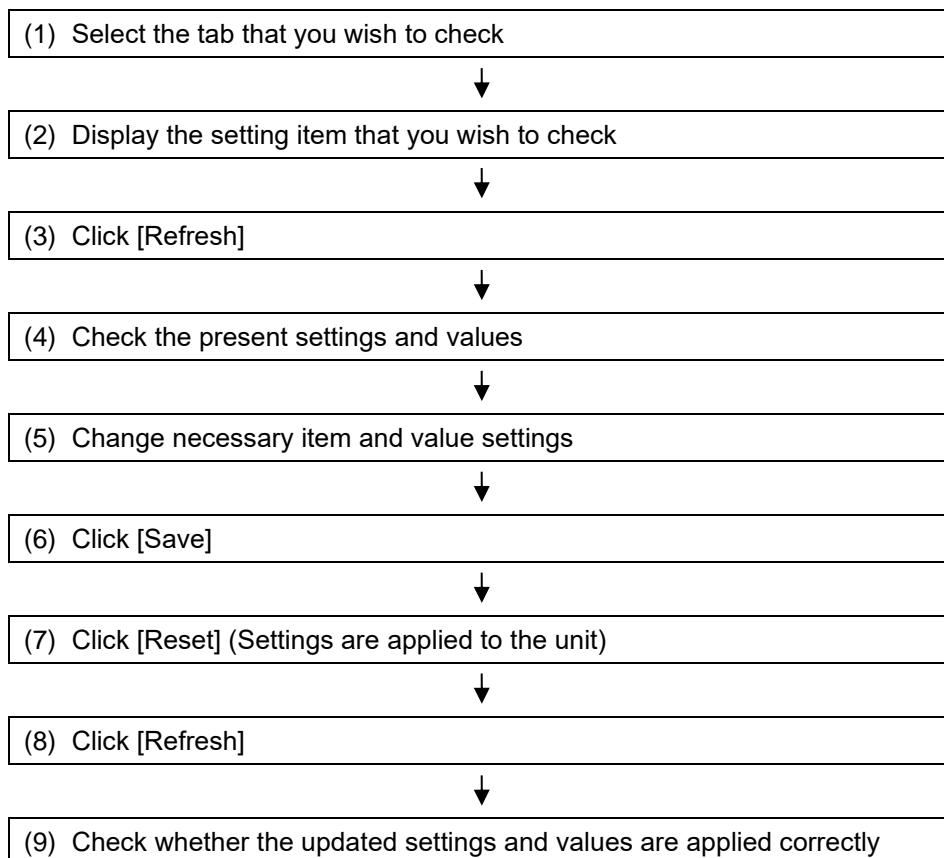

Setting/Adjustment of the Wireless Unit

Parameter settings of a Remote (optional)

Change the parameter settings of the EXW1-RD* Remote.

- Remote setting



•The setting will be applied when the Remote is turned on (or reset).

(1) Input size: 16 points/2 byte

(2) Output size:(includes valves) 16 points/2 byte

(3) Wireless signal: Active

(4) Power Supply Voltage Monitor (Control/Input) Enable

(5) Power Supply Voltage Monitor (Output) Enable

(6) Output action when upper communication to cut off. CLEAR

(7) Output action when wireless community to cut off. HOLD

Remote setting

	Parameter name	Set value	Initial value	Note
(1)	Module input size*	16 points (16 bits)	16 points (16 bits)	Fixed
(2)	Module output size*	16 points (16 bits)	16 points (16 bits)	Fixed
(3)	Wireless communication	Active/Idle	Active	
(4)	Detection of a drop in the US1 (for control / input) power voltage	Enable/Disable	Enable	
(5)	Detection of a drop in the US2 (for output) power voltage	Enable/Disable	Disable	Exclusive to EXW1-RDY*and EXW1-RDM*
(6)	Output while upper communication is not established	Clear/Hold	Clear	
(7)	Output while wireless communication is not established	Clear/Hold	Hold	

* Although the number of occupied inputs/outputs of EXW1-RDM* is fixed at 16 (16 bits), only the lower 8 bits are available.

(1) Module Input size

In the case of EXW1-RD*, the number is fixed at 16 (16 bits).

* Although the number of occupied inputs of EXW1-RDM* is fixed at 16 (16 bits), only the lower 8 bits are available.

(2) Module output size

In the case of EXW1-RD*, the number is fixed at 16 (16 bits).

* Although the number of occupied outputs of EXW1-RDM* is fixed at 16 (16 bits), only the lower 8 bits are available.

(3) Wireless communication

If it is set to "Idle", the wireless communication is disconnected.

(4) Detection of a drop in the US1 (for control / input) power voltage

If it is set to "Enable", a drop in the US1 (for control / input) power supply voltage can be detected.

(5) Detection of a drop in the US2 (for output) power voltage

If it is set to "Enable", a drop in the US2 (for output) power supply voltage can be detected.

(6) Output while upper communication is not established

Specify an output action for when the fieldbus communication is disconnected.

CLEAR: Clear the output.

HOLD: Fix the output at the current value.

Individual: Each output setting can be specified.

CLEAR, HOLD, SET: Output ON

(7) Output while wireless communication is not established

Specify an output action for when the wireless communication is disconnected.

CLEAR: Clear all Remote output.

HOLD : Fix all the Remote output at the current value.

Parameter settings of the Base

The following two parameter settings are available for the compact wireless Base.

- CC-Link setting
- System setting

CC-Link setting

Change the operation mode, speed and number of stations settings as needed.

The screenshot shows the 'I/O Configurator 2.9.0' window with the 'Wireless' tab selected. Under 'Control panel', 'CC-Link Setting' is selected. The 'CC-Link Setting' section contains the following parameters:

- Operating mode: 2 (highlighted with a red box and labeled (1))
- Max. Remote units: 15Remote
- CC-Link version: 1.10
- Extension Cycle(s): 1times
- Occupied station(s): 4
- RX/RX: 128 bits / 128 bits
- RWr/RWw: 16 words / 16 words
- Speed: 10Mbps (highlighted with a red box and labeled (2))
- Number of slave stations: 1 (highlighted with a red box and labeled (3))

Buttons for 'Import', 'Export', 'Reset module', 'Refresh', 'Power on', 'R/W detected', 'Save all', and 'Read factory data' are also visible.

Parameter name	Set value	Initial value	Note
(1) Operation mode	1~8	2	Settings for CC-Link Version, number of occupied stations, etc.
(2) Transmission speed setting	156k/625k/ 2.5M/5M/10Mbps	156kbps	
(3) Station number setting	1-64 stations	0	Change the setting in accordance with the installation condition.

(1) Operation mode setting

This setting specifies a CC-Link operation mode.

Setting range: 1-8

Operation Mode	Maximum number of remote registration units allowed by the system *1	CC-Link setting			Occupied area	
		CC-Link Ver	Extended cyclic	Number of occupied stations	Bit area RX/RX ^{*2}	Word area RWr/RWw
1	15	1.10	x1	2	64/64	8/8
2	15	1.10	x1	4	128/128	16/16
3	15	2.00	x8	2	384/384	64/64
4	15	2.00	x8	4	896/896	128/128
5	31	2.00	x8	2	384/384	64/64
6	31	2.00	x8	4	896/896	128/128
7	63	2.00	x8	4	896/896	128/128
8	127	2.00	x8	4	896/896	128/128

*1 The actual number of units that can be registered depends on the operation mode and remote type.

*2 The last register of the bit area (16 bits) cannot be used as it is allocated for the system area.

Example) If the size of the Bit area is 896/896, the actual available size is 880/880.

(2) Transmission speed

Specifies a CC-Link communication speed.

Setting range: 156 k/625 k/2.5 M/5 M/10 Mbps

(3) Station number setting

Specifies a station number to assign to the compact wireless Base (Remote device station) on CC-Link.

Setting range: 1-64

* The settable range varies depending on the selected operation mode (number of occupied stations).

* To avoid a station number conflict, the station number is set to 0 (station number error) by default. Change the station number in accordance with the unit installation condition.

System setting

Change parameter settings as required.

(1) I/O mapping: Manual

(2) Diagnostic allocation: Advanced

(3) DA refresh time(sec): 1s

(4) Output Action of Upper Comm: Clear

(5) Time of Wireless Communication: 500msec

(6) Input Information of Wireless: Hold

(7) Wireless signal: Active

(8) Protocol: V.1.0

(9) Time Information: Unsynchronous(0days 00:04:45)

(10) Synchronize time

System setting parameters

Classification	Parameter	Set value	Initial value	Note
System Setting	(1) I/O mapping	Fixed mapping	Fixed mapping	
	(2) Diagnostic mapping	Advanced	Advanced	
	(3) Analog output update time*1	0.1/0.2/0.5/1/2/5/10/30/60 s	1 s	
	(4) Output while upper communication is not established	Clear/Hold/Individual	Clear	Output action setting for when the upper communication is abnormal
	(5) Wireless communication timeout	20/40/100/200/500/1,000/2,000/5,000 msec	500 msec	Activated only when protocol V.2.0 is used
	(6) Input information while wireless communication is not established	Clear/Hold	Hold	Input information when the wireless communication is disconnected
	(7) Wireless communication	Active/Idle	Active	
	(8) Protocol	V.1.0/V.2.0	V.1.0	
	(9) Time information	-	-	
	(10) Time synchronization	-	-	

*1: It is necessary to set the data update time for each analog input unit connected to the wireless Remote.



- The protocol version is set to V.1.0 by default; to use the 1 Mbps wireless communication speed and the frequency channel select function (F.C.S.) in a wireless system consisting solely of EXW1 series devices, change the protocol version to V.2.0 before pairing them.

- (1) I/O mapping
Specifies an I/O mapping method.
Setting range: fixed
- (2) Diagnostic mapping
Specifies diagnosis information to map to the Word area.
Setting range: Advanced
Advanced (System diagnosis + Remote connection / diagnosis / registration information)
* Refer to "Diagnostic mapping" for details.
- (3) Analog output update time
Set the data update time of the analog output unit connected to the wireless Remote.
Setting range: 0.1/0.2/0.5/1/2/5/10/30/60 s (Initial value 1 s)
* The analog input update time is set for every wireless Remote unit.
- (4) Output while upper communication is not established
Sets the output action of the **entire wireless system** for when the CC-Link communication is disconnected.
CLEAR: Clear the output.
HOLD: Fix the output at the current value.
Individual: The set value of each wireless Remote is valid (not the entire system)
* The [CLEAR] and [HOLD] values of the [Output while communication is not established] setting of EX600-WEN/WPN/WSV specifies output actions for valves and IO units (EX600-DYP* etc.) connected to EX600-WEN/WPN/WSV. Note that **this setting does not apply to the wireless-system-wide output action (different from EXW1-BMJA*)**.
- (5) Wireless communication timeout
If wireless communication (including retries) does not succeed due to obstacles or for other reasons, it is judged to have failed after a set amount of time and disconnected. Then, the Base and the Remote are reconnected.
Setting range: 20/40/100/200/500/1,000/2,000/5,000 msec
- (6) Input information while wireless communication is not established
Specifies input information for when the wireless communication is disconnected.
CLEAR: Clear the input.
HOLD: Fix the input at the current value.
- (7) Wireless communication
Sets the operation status of wireless communication.
Active: Wireless communication output is active
Idle: Wireless communication output is idle

(8) Protocol

Sets the wireless communication protocol.

* To pair with an EX600-W series unit, V.1.0 must be set.

This also applies when building a wireless system consisting of both EXW1 and EX600-W series.

•V.1.0: The same wireless communication method as EX600-W is used, and the [Frequency channel select function (F.C.S.)] is unavailable. The communication speed is 250 kbps.

•V.2.0: This can be applied to a wireless system consisting solely of EXW1 series units.

The [Individual setting of Output while upper communication is not established] and [Frequency channel select function (F.C.S.)] are available. The communication speed is 1 Mbps.

See the table of combinations provided below.

Combination*4		Applicable function			
Wireless Base	Wireless Remote	Communication distance	Protocol	Frequency channel select function (F.C.S.)	Web function
EXW1	EXW1	Up to 100 m	V.1.0/V.2.0	Available*1	-
EXW1	EXW1+EX600	*2	V.1.0	NA	-
EXW1	EX600	Up to 10 m	V.1.0	NA	-
EX600	EXW1	Up to 10 m	V.1.0	NA	Available*3
EX600	EXW1+EX600	Up to 10 m	V.1.0	NA	Available*3
EX600	EX600	Up to 10 m	V.1.0	NA	Available

*1: Available in protocol V.2.0.

*2: Up to 100 m between an EXW1 series Base and Remote, and up to 10 m between an EXW1 series Base and an EX600-W series Remote.

3: The settings and monitor function are restricted when EX600-WEN/WPN and EXW1-R are used in combination.

*4: For combinations involving EX600-W series, refer to the operation manual for the product in use.



•The protocol can be changed only when no Remote is registered in the EXW1-BMJA*.

Make changes only after unregistering any registered Remotes.

Note that an unregistration pop-up window will appear in the I/O Configurator.

(9) Time information

The time information is the time that the product recognizes. It is used for a timestamping event and other logs.

Until "synchronization" is performed, it displays the time elapsed since startup.

(10) Time synchronization

This sends the time information of the PC to the product and synchronizes it. If the time information of the PC is needed for a timestamping event and other logs, perform time synchronization.

Frequency channel select function (F.C.S.)

The frequency channel can be selected using this function. Since only protocol V.2.0 supports it, specify protocol V.2.0 in the system settings when using it.

* The number of selectable frequency channels varies depending on the country in use. For more details, check the product number.

- Certified countries other than the US, Canada, Korea and Brazil: ch 5-79
- Certified countries including the US, Canada, Korea and Brazil: ch 15-79

* If no channel is selected, communication is established on ch 79 by default.

Follow the steps below to configure the function on the Remote unit registration screen on the Properties tab.

- (1) Set [Pairing] to pairing unavailable.
For details on pairing settings, refer to Pairing and Unpairing Procedures.
- (2) Click FCS Setting.

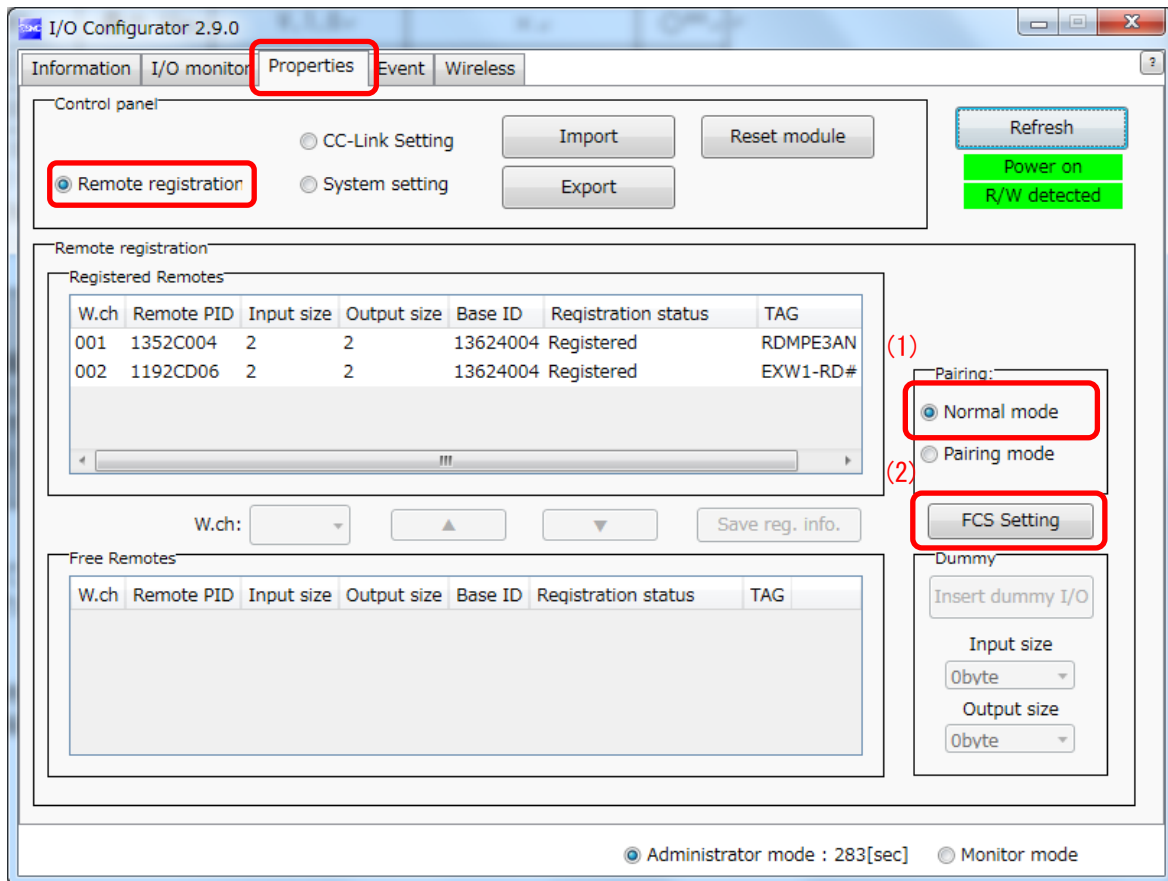

When FCS Setting is clicked, the following screen is displayed.

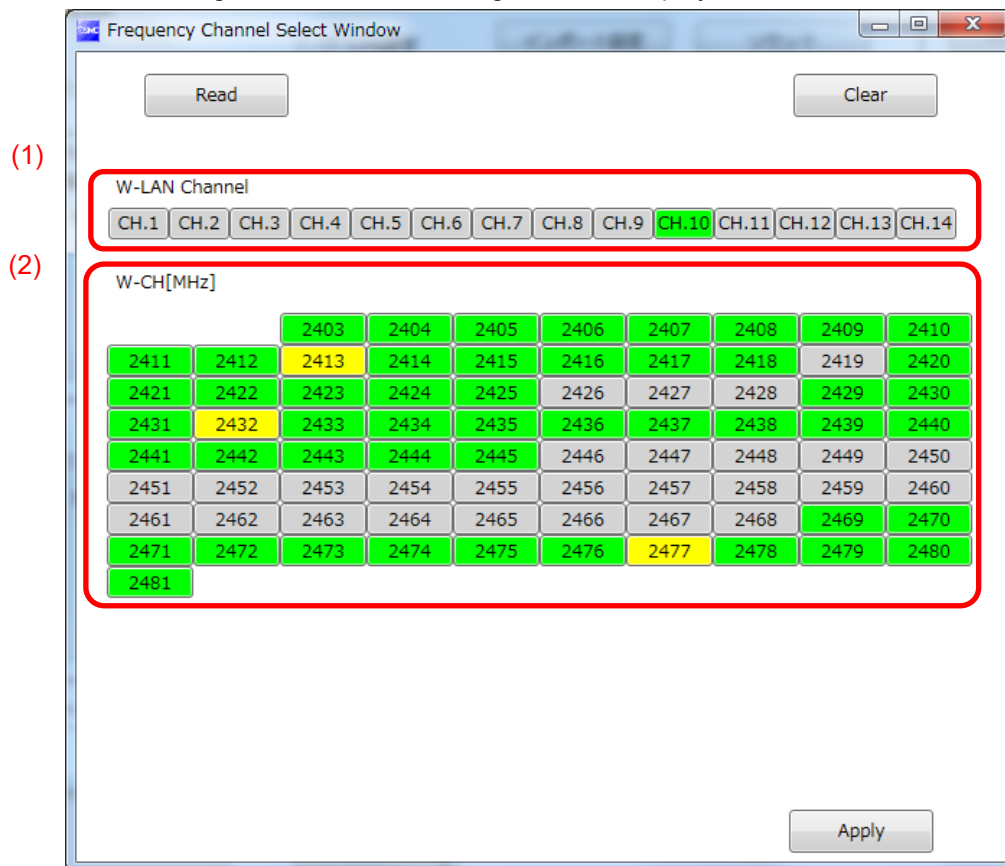

(1) W-LAN Channel indicators

The W-LAN indicators make it possible to select frequencies corresponding to W-LAN channels at one time.

* In the example above, W-LAN Channel: CH.10 is selected.

(2) W-CH indicators

The W-CH indicators make it possible to select frequencies for each CH.

* In the example above, frequencies 2419, 2426-2428, and 2446-2468 [MHz] are unused Channels.

Note that frequencies 2446-2468 [MHz] correspond to (1) W-LAN Channel: CH.10 above.

•Indicator colours

Colour	Description	Remarks
Green	Selected W-LAN channel (W-LAN Channel area) Active frequency channel (W-CH area)	
Yellow	Advertise channel	Cannot be set for inactive frequency channels
Grey	Inactive frequency channel	



- If advertise channels are included in the CH at the time of selecting a W-LAN Channel, they cannot be selected. To select them, initialize the product or remove all the registered Remotes and then configure F.C.S. before performing pairing.
- To use 5-7 frequency channels, neighboring frequencies need to be separated by 3 MHz.
- To use 8-14 frequency channels, neighboring frequencies need to be separated by 2 MHz.
- To use 15 frequency channels or more, neighboring frequencies can be selected.

Event

This makes it possible to check the event information of the wireless Base or wireless Remotes.

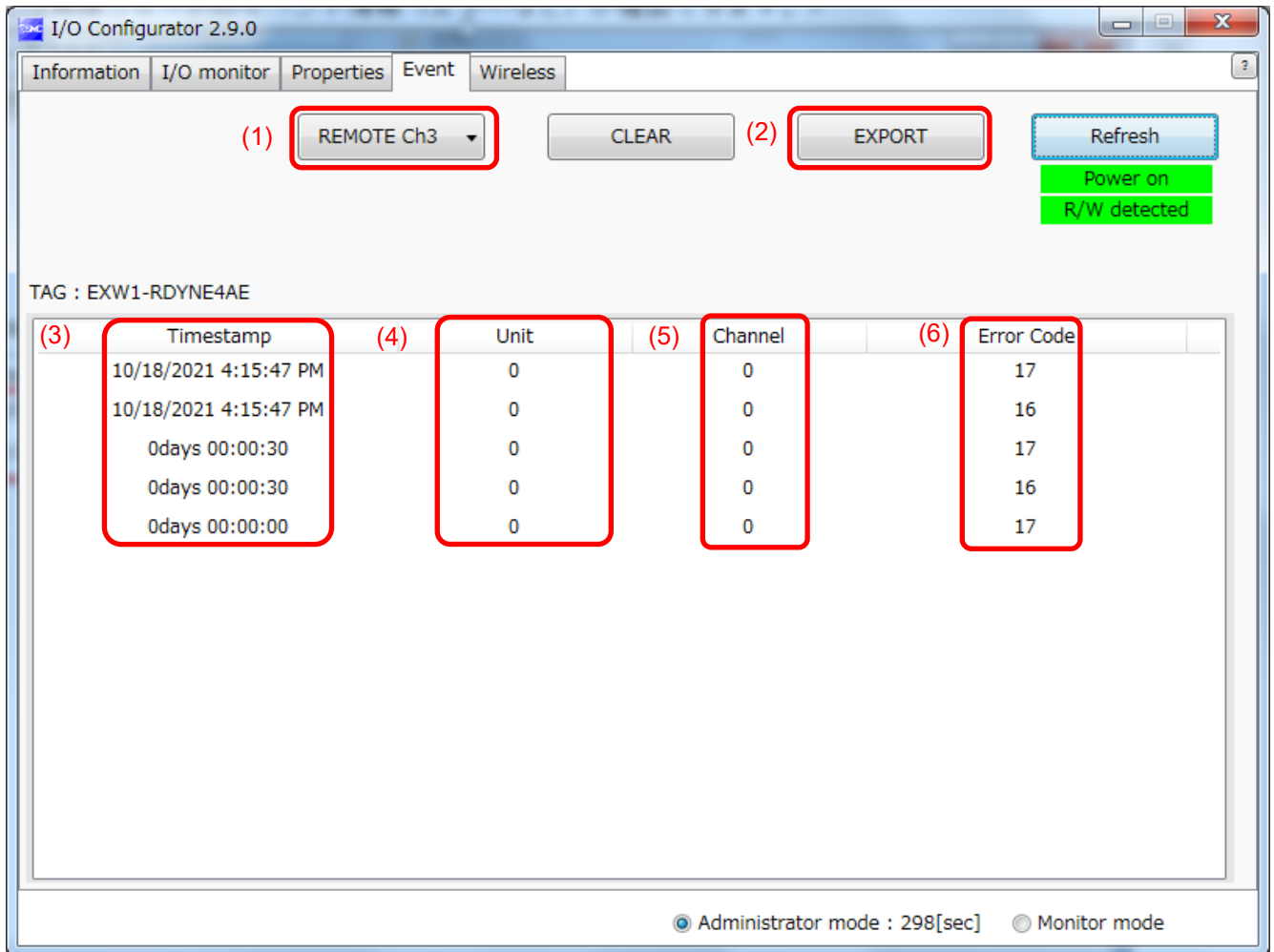

(1) Model selection

Select the wireless Base or a Remote registered in the wireless Base.

(2) Event data export

Event data can be exported to text files.

(3) Time stamp

The time when the event was obtained is displayed. Time-synchronized time is displayed only in the case of protocol V.2.0.

* Time synchronization needs to be performed in System setting on the Properties tab. If time is not synchronized, the time elapsed since the product is turned on is displayed.

(4) Unit

The unit No. is displayed.

(5) Channel

The channel No. of the wireless Remote is displayed.

(6) Error Code

The error code is displayed.

The table below shows error codes and corresponding details and diagnostics maps.

Error Code	Description	Diagnostics map		
		Item	Bit No.	
1	Detection of a short circuit of US1 or US2	System diagnostic 1	6 or 7	
2	Detection of the range upper limit		3	
3	Detection of the range lower limit		2	
6	Detection of unconnected load		5	
7	User setting upper limit detection		1	
8	User setting lower level detection		0	
9	Detection of the upper limit of the ON/OFF cycles		4	
16	Detection of US1 power supply voltage drop		System diagnosis 2	9
17	Detection of US2 power supply voltage drop			8
19	Connection failure between units (during operation)	11		
20	Connection failure between units (when power is supplied)	12		
22	Detection of system error (when power is supplied)	14		
23	Detection of hardware error (during operation)	15		
64	Abnormal number of input / output points setting error	System diagnosis 3	0	
70	Detection of system error		6	
71	Detection of hardware error		7	
72	Number of system input / output points setting error	System diagnosis 4	8	
73	Number of registered Remotes setting error (Outside of the wireless channel setting range)		9	
76	Network setting error		12	
78	Wireless registration data corrupted		14	
79	Detection of wireless hardware error		15	

Wireless

This screen displays wireless log data.

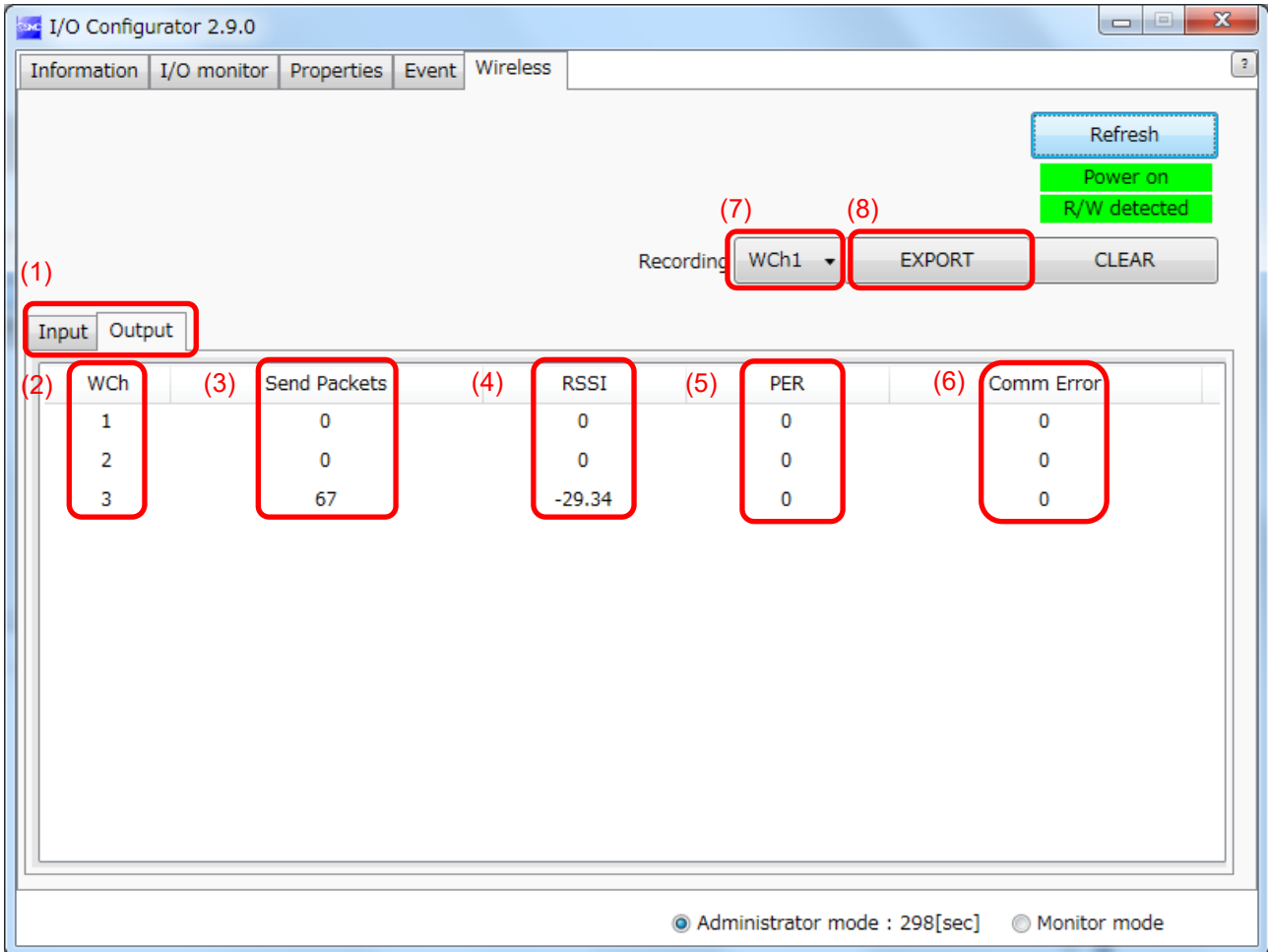

(1) Input/ Output Tabs

Wireless-Based received data is displayed on the Input tab, and transmission data is displayed on the Output tab.

(2) WCh

The wireless channel is displayed.

(3) Send Packets (or Received Packets on the Input tab)

The number of transmitted/received packets is displayed.

(4) RSSI (Received Signal Strength Indicator)

The radio wave receiving intensity is displayed.

(5) PER (Packets Error Rate)

The packet error rate is displayed.

(6) Comm Error (Communication Error)





The number of communication disconnections is displayed.

(7) Selection of wireless channel

Select the wireless channel to obtain wireless log data.

(8) Export of wireless log data

The wireless log data of the selected wireless channel is exported. Wireless log data is divided into four csv files.

Name	Date modified	Type	Size
 AllInfo.csv	2021/10/01 15:53	Microsoft Excel CS...	1 KB
 RcvRSSI.csv	2021/10/01 15:53	Microsoft Excel CS...	6 KB
 Retries.csv	2021/10/01 15:53	Microsoft Excel CS...	1 KB
 SndRSSI.csv	2021/10/01 15:53	Microsoft Excel CS...	7 KB

Pairing and Unpairing Procedures

Pairing Procedure

Pairing a Base with a Remote

Pairing is required for communication between a Base and Remote.

A Base is paired with a Remote after they are switched to pairing enabled mode.

Pairing and registration between a Base and Remote enables wireless communication.

○Operational flow during pairing

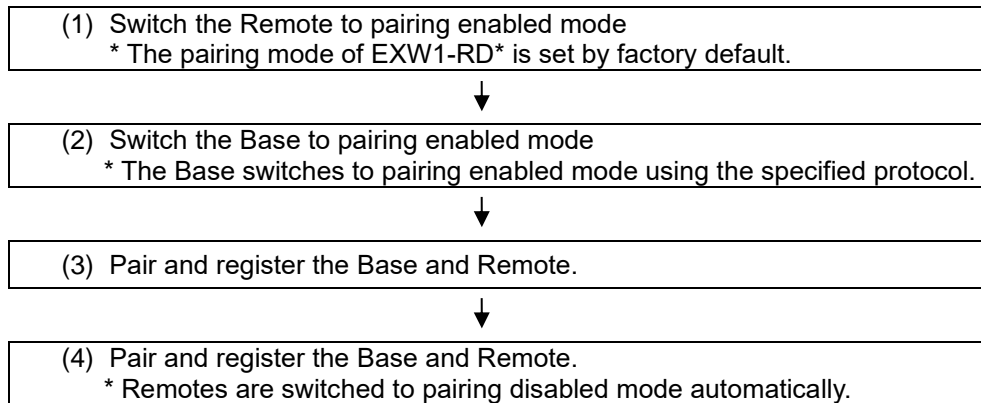

- After changing the operation mode for pairing, the mode is changed by clicking the [Reset] button or re-supplying power so that the mode will be changed to the Remote registration or listing for connection.
Do not pairing and additional pairing to another unit during the operation.
- For the Input size and Output size of the remote, the setting of wireless registration will be reflected to the base. When changing the number of Input size and Output size of the remote, wireless registration should be performed again.

(1) Switch the Remote to pairing enabled mode

Switch the Remote to pairing enabled mode. Select the [Properties] tab and then click [Refresh]. Select [Pairing enabled] from [Pairing setting] on the [Properties] tab and then click [Reset].

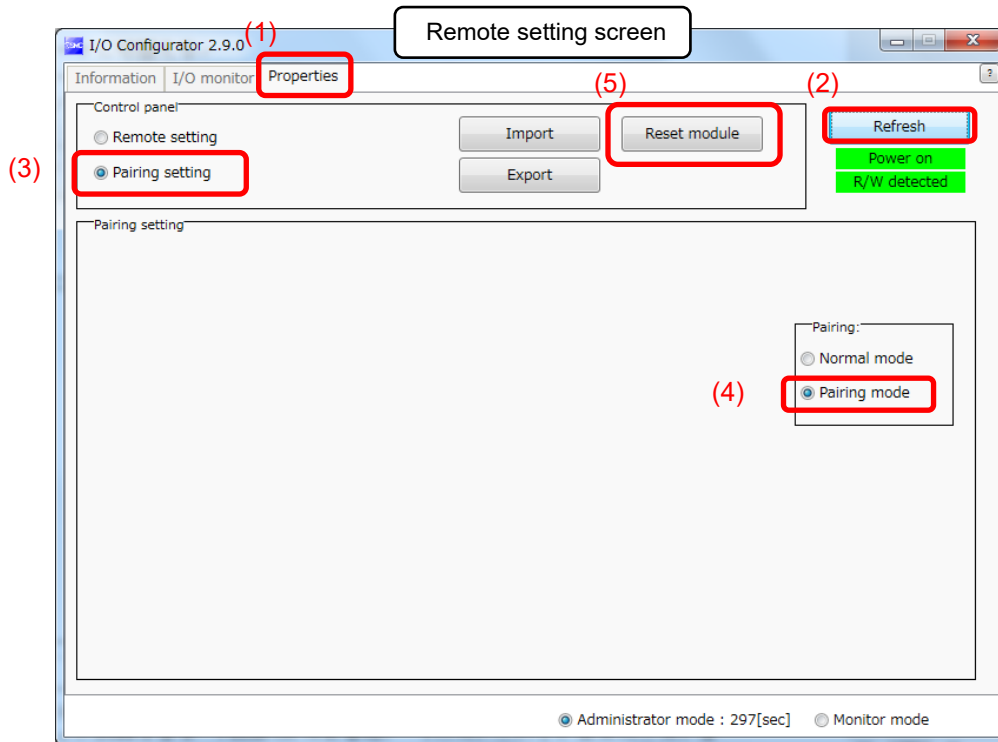

(2) Switch the Base to pairing enabled mode

Select the [Properties] tab and then click [Refresh]. Select [Pairing enabled] from [Remote unit registration] on the [Properties] tab and then click [Reset]. [setting] Note that

*** A switch to Pairing enabled mode is made using the protocol specified in System setting; select a protocol with the Remote to pair with taken into consideration and then make a change to Pairing enabled mode.**

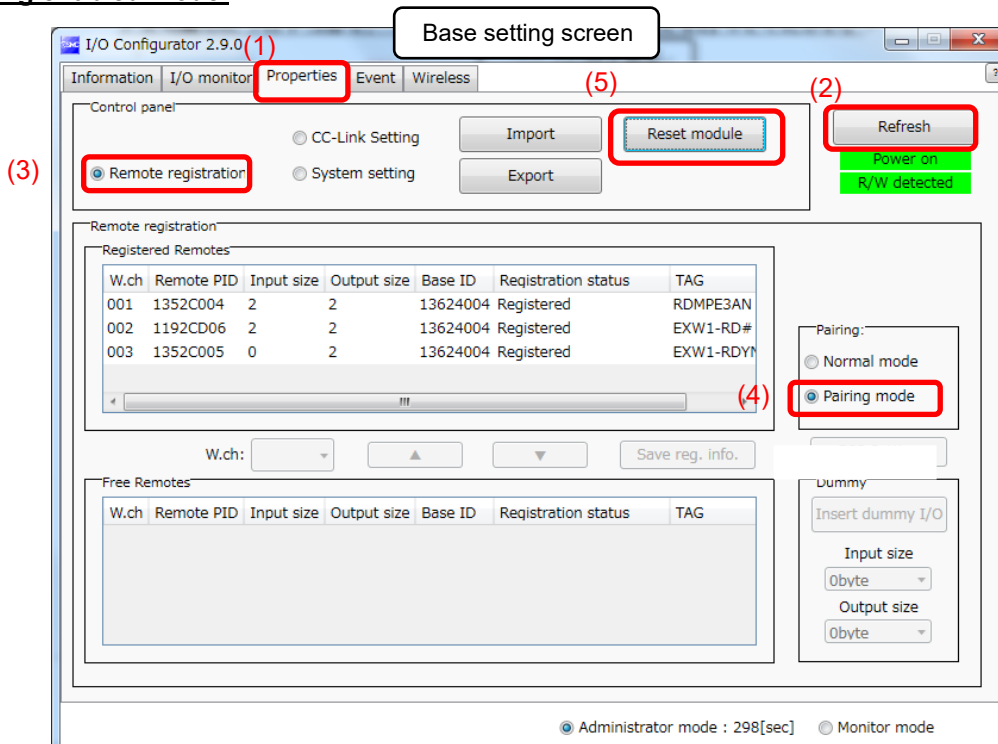

(3) Pair and register the Base and Remote

Clicking [Refresh] causes the Remote in Pairing enabled mode to be listed in the Free Remote view.

Select the Remote that you wish to register, specify a wireless channel and then click ▲.

If the Remote that you wish to pair with does not appear, click [Refresh] again. If the problem still persists, the cause may be any of the following: **1. The Remote is not switched to Pairing enabled mode, 2.**

The

Remote is not turned on and **3. The Remote is registered or waiting to be registered to another Base.**

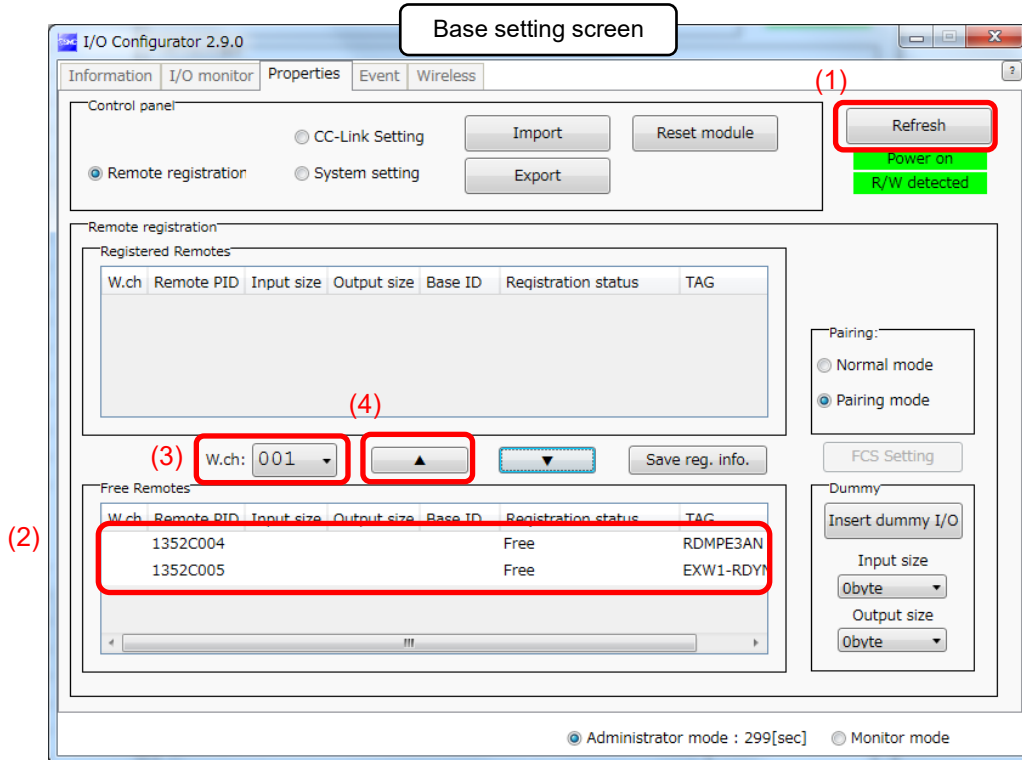

The Remote that is to be registered on the specified wireless channel moves to the Registered Remotes area. Make sure that the registration status is Registered Wait, and click [Save reg. info.].

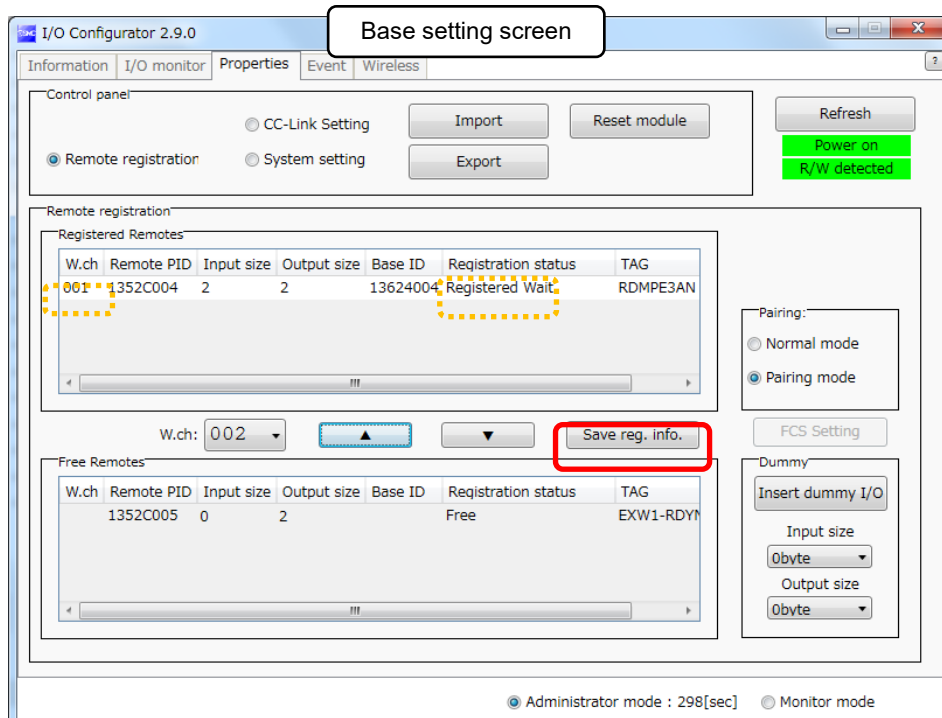

Click [Reset] and [Refresh] and check that the registration status changes to "registered".

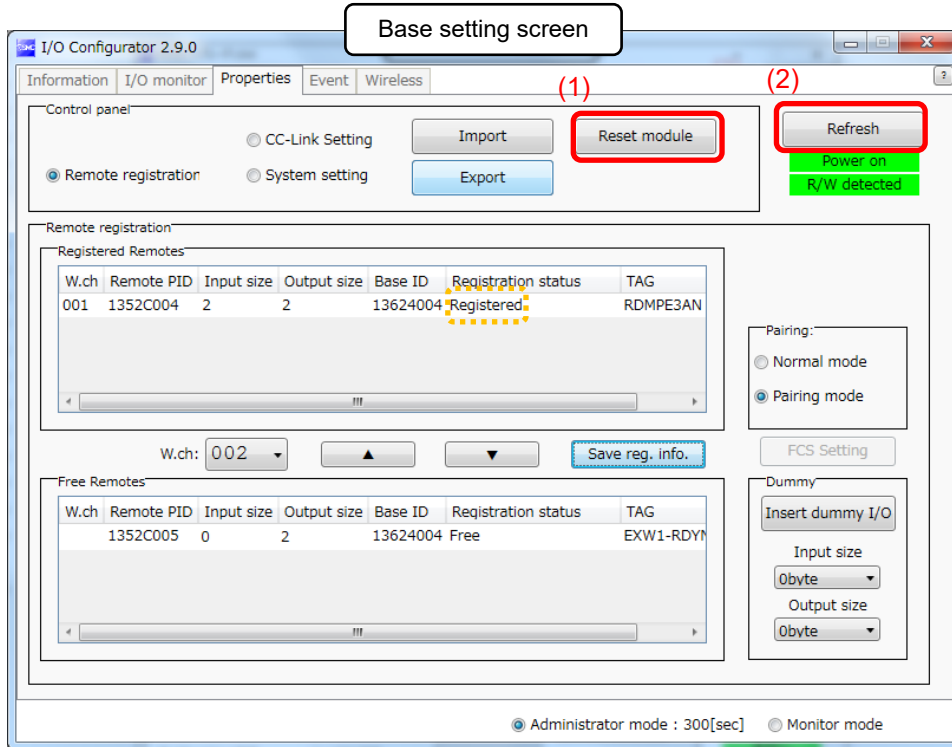

* The example below shows two Remote modules registered on CH1 and CH2.

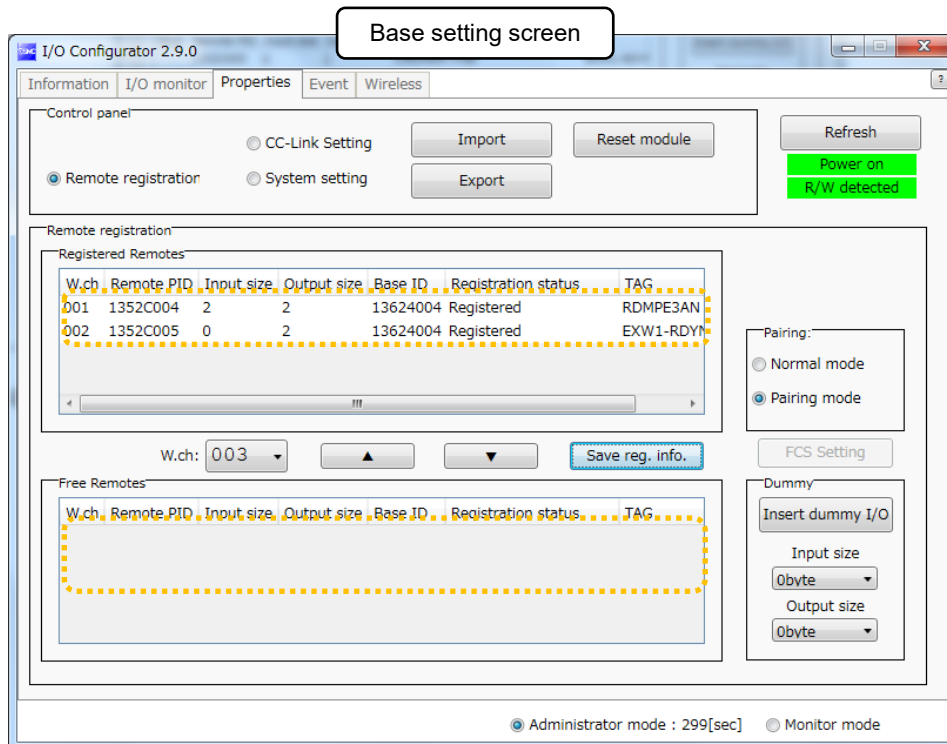

Configure the registration of the dummy Remote as necessary.

(4) Disable the Pairing enabled mode of the Base (Pairing disabled mode)
Set the Base to Pairing disabled mode and click [Reset].

•Dummy Remote

The dummy Remote can register a "Dummy area" in the I/O map. A Remote can be added without changing the I/O map by registering the Remote to the "Dummy area" even after system configuration.

The Remote mapping order to the I/O map is from the smallest channel to the largest channel registered by the wireless channel which has been set during Remote.

At the time, the wireless channel in which no Remote is registered will be ignored.

When adding a new Remote, it may be required to change the I/O map depending on the wireless channel number.

The dummy Remote can be registered only with the Base unit.



•To reserve the dummy Remote registration, it is necessary to set the number of inputs / outputs. If a Remote with inputs / outputs which are different from the set numbers is registered, the I/O map should be changed.

○Switching pairing modes using a button on the Remote

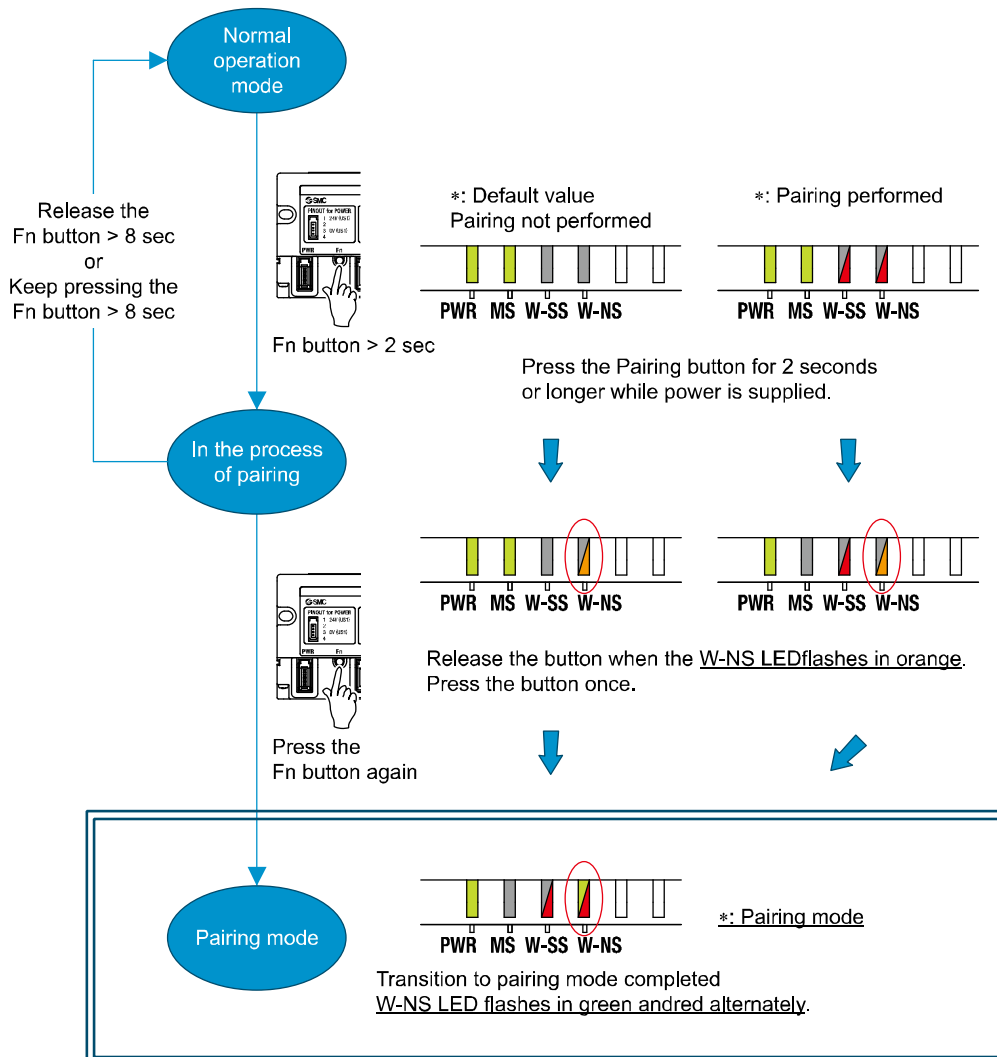

Because of the button, a Remote e-CON type does not require the NFC for switching pairing modes.

Note that the LED state above indicates that the Base is in pairing disabled mode.

When the Base is in pairing enabled mode, W-SS lights up green or flashes

Unpairing Procedure

Removing Pairing between a Base and Remote

Pairing between a Base and Remote will be removed.

When you wish to reconfigure the wireless system, such as changing the I/O sizes of a registered Remote, pairing needs to be removed and registered again.

○Operational flow during unpairing

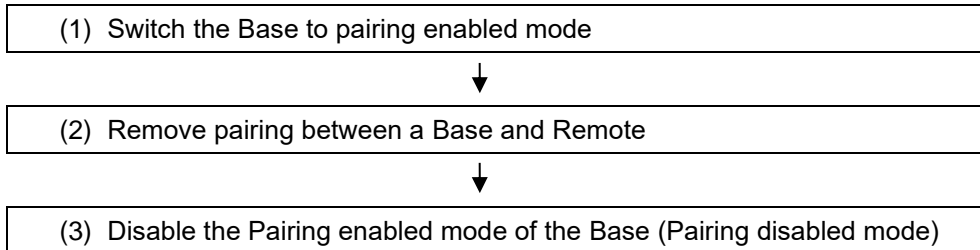

(1) Switch the Base to pairing enabled mode

Switch the Base to pairing enabled mode. Select the [Properties] tab and then click [Refresh]. Select [Pairing enabled] from [Remote unit registration] on the [Properties] tab and then click [Reset]. [setting]
 * The example below shows two Remote modules registered on CH1 and CH2.

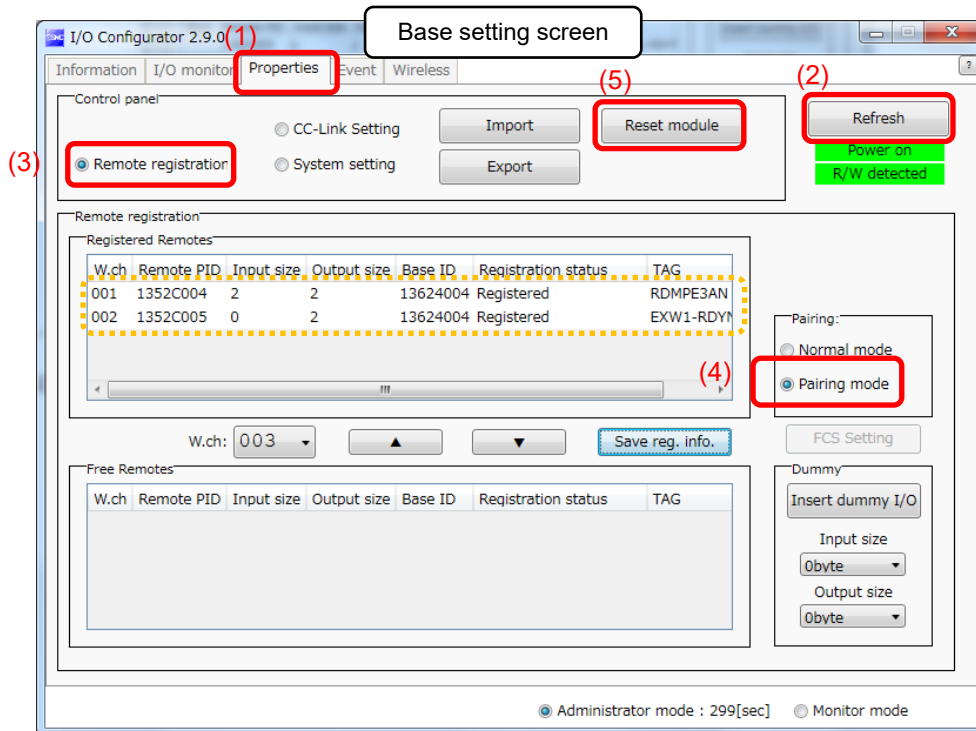

(2) Removing the pairing between the Base and Remote

Pairing between the Base and Remote will be removed.

Click [Refresh]. Select the Remote that you wish to unpair from the registered Remotes and click ▼, which in turn causes the selected Remote to move to the Free Remotes area. Clicking [Save reg. info.] finalizes the unregistration of the Remote.

! •If a Remote moved to the Free Remotes area is not in Pairing enabled mode, clicking [Refresh] after finalizing the unregistration of the Remote causes the Remote moved to the Free Remotes area to be hidden.

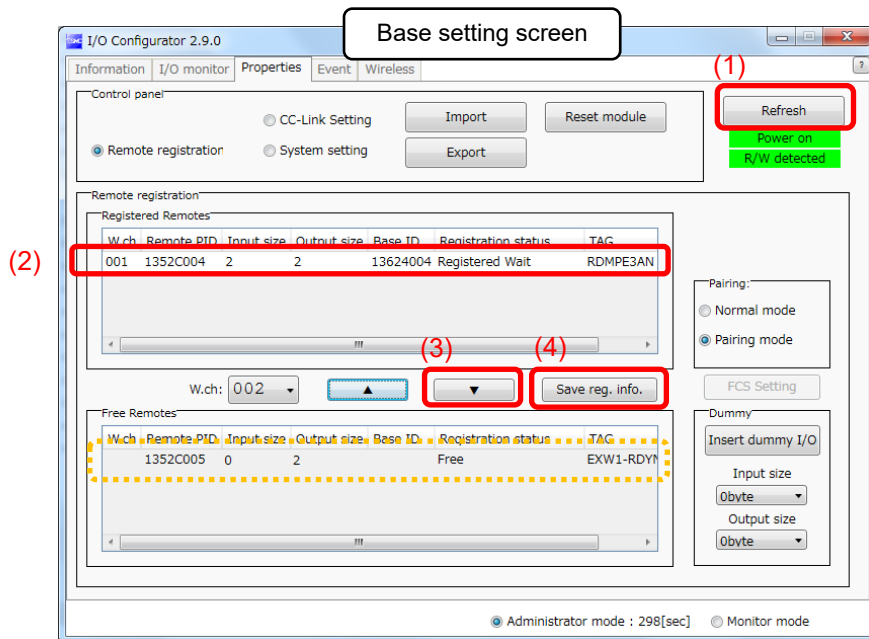

* The example below shows two Remotes unregistered.

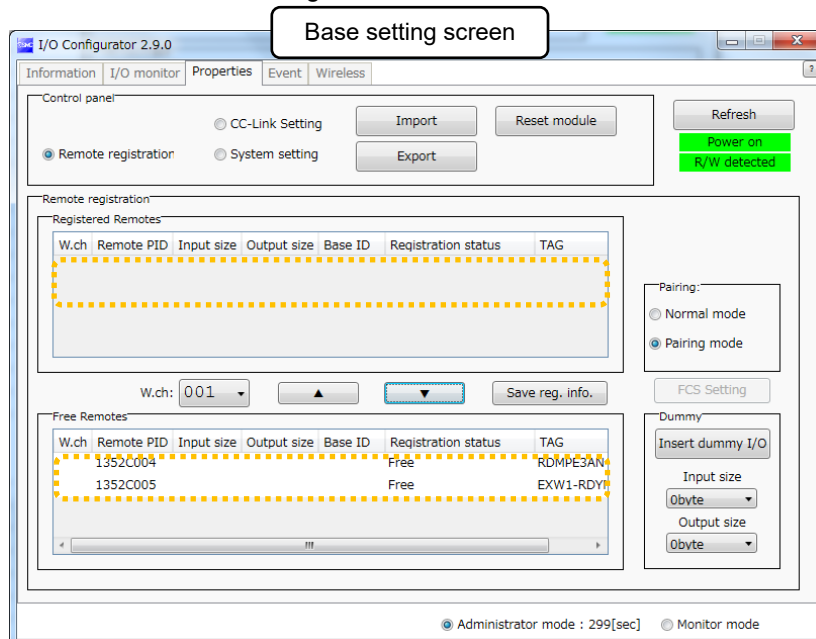

(3) Disable the Pairing enabled mode of the Base (Pairing disabled mode)
Set the Base to Pairing disabled mode and click [Reset].

Mounting and Installation of Units

EXW1-BMJ*, EXW1-RD*

Installation

Compact wireless Base/Remote

⚠ Caution

- To avoid damage to parts, apply the recommended tightening torque.
- Mount the product using two screws.

2 x M4 screws are required (Recommended torque = 0.8+/-10% N·m).

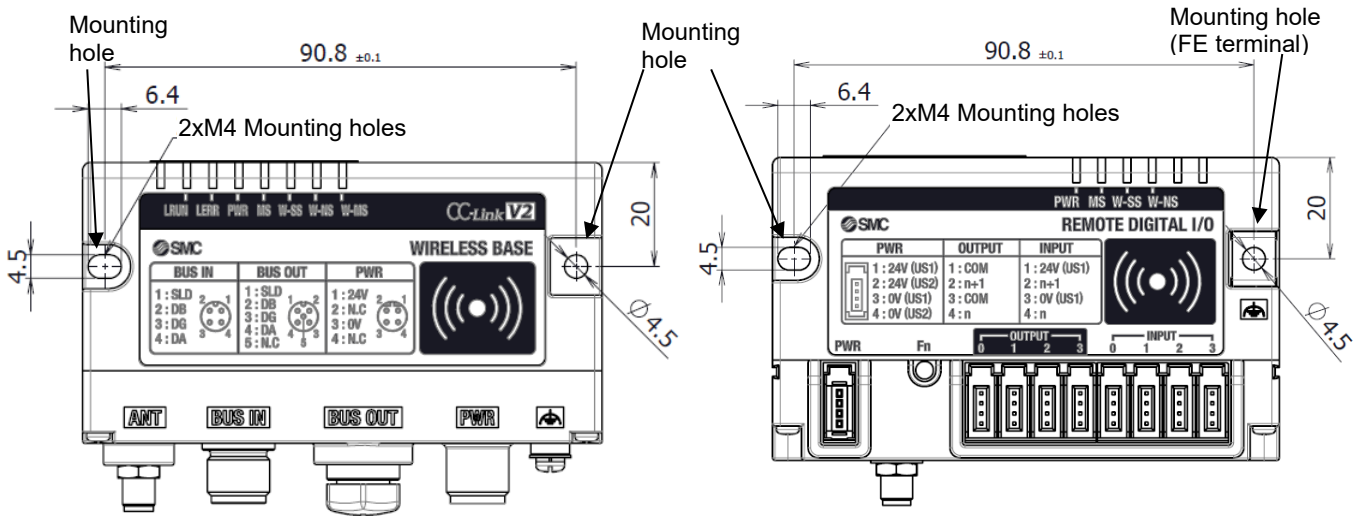

External Antenna

Caution

- avoid damage to parts, apply the recommended tightening torque.

2 x M4 screws are required (Recommended torque = $1.3 \pm 10\%$ N·m).

Refer to the operation manual attached to the external antenna set for details.

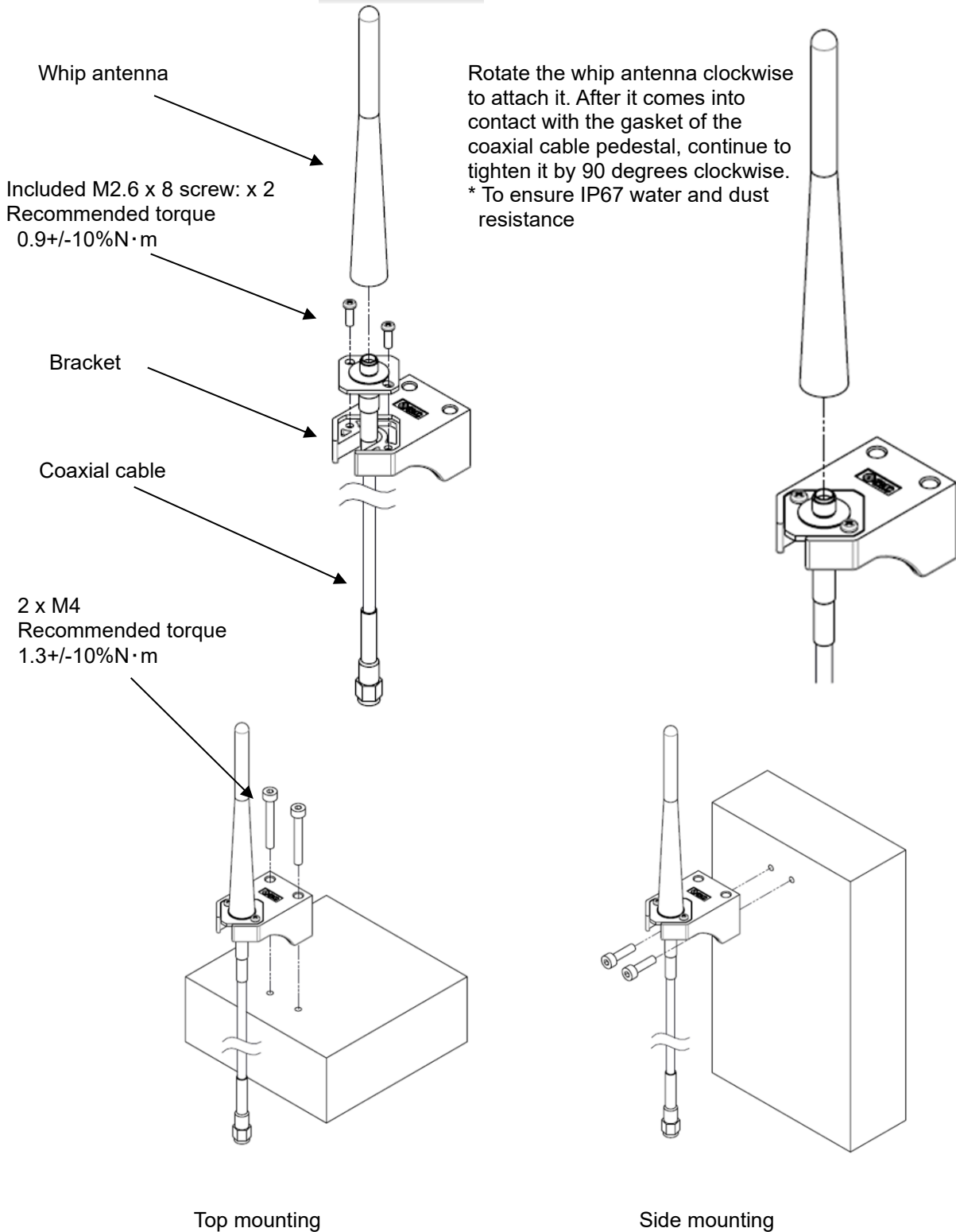

Attach the male connector of the coaxial cable to the antenna connector of the wireless unit by rotating it clockwise. (Tightening torque $0.9 \pm 10\% \text{ N} \cdot \text{m}$)

To install the wireless unit inside a distribution box or other container, pass the coaxial cable through a rubber bushing and into the box in which the wireless unit is installed, and attach its connector to the antenna connector of the wireless unit.

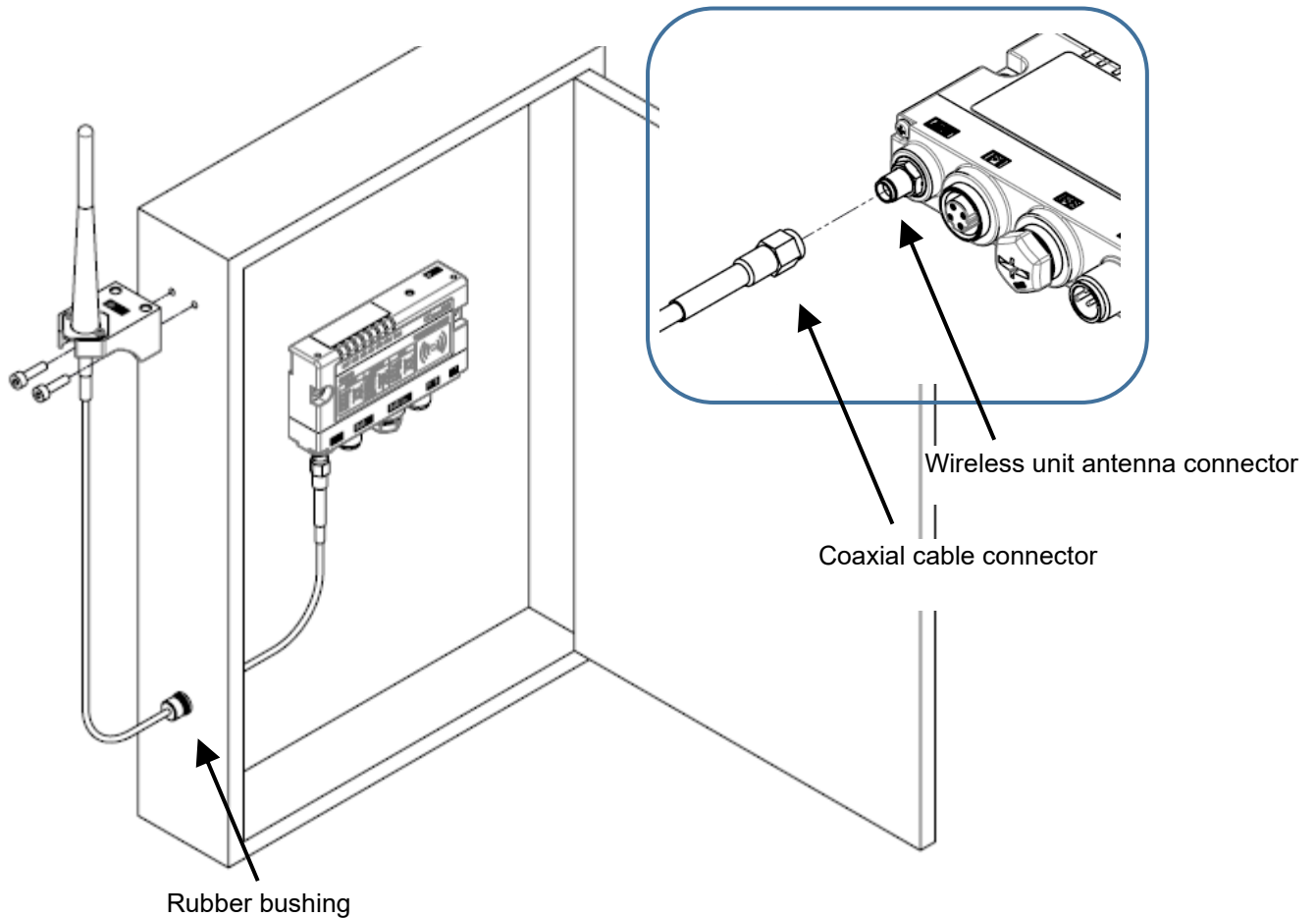

Installation example

Troubleshooting

When problems occur, take appropriate countermeasures while referring to the LED indication, troubleshooting and parameter settings.

If a cause applicable to the failure cannot be identified, this indicates that the equipment itself is broken. The fieldbus system damage can be caused by the operating environment. Contact SMC to obtain countermeasures.

•Base troubleshooting items

LED	Description	LED status		No.	
		Colour of LED	ON/Flashing		
-	All LEDs are OFF.	-	-	Problem 1	
PWR	PWR is OFF	-	OFF	Problem 2	
MS	MS LED does not turn on green.	Red	Flashing	Problem 3	
		Red	ON		
		-	OFF		
W-SS	W-SS LED flashes red or orange or is off	Red	Flashing	Problem 4	
		Orange	Flashing		
		-	OFF		
W-NS	W-NS LED does not turn on green.	Green	Flashing	Problem 5	
		Red	Flashing		
		Red	ON		
		Red	Green		Alternate Flashing
		-	OFF		
W-MS	W-MS LED does not turn on green.	Red	Flashing	Problem 6	
		Red	ON		
		-	OFF		
L RUN	L RUN LED is OFF	-	OFF	Problem 7	
L ERR	L ERR LED is RED	Red	ON	Problem 8	
Problems related to the NFC				Problem 9	

•Base troubleshooting

Problem No.	LED name	LED status		Possible causes	Investigation and countermeasures
		Colour of LED	ON/Flashing		
1	All	-	OFF	The US1 (for control) power supply is OFF	Supply 24 VDC +/-10% for US1 (for control) power source.
2	PWR	-	OFF	The US1 (for control) power supply is OFF	Supply 24 VDC +/-10% for US1 (for control) power source.
3	MS	Red	Flashing	The following diagnostic information is detected.	After checking the error contents while referring to the system diagnostic information and LED indication, refer to the following countermeasures.
				(1) US1 (for control) power supply voltage level is abnormal	(1) The US1 (for control) power voltage is low. Supply 24 VDC +/-10%.
		(2) Number of system input / output points setting error	(2) The number of wireless system inputs/outputs has exceeded the set value. Reduce the number of inputs/outputs mapped to the wireless system (Base and Remotes) below the number of inputs/outputs specified in the operation mode of the Base. Change the operation mode of the Base or the number of inputs/outputs mapped to the wireless system (Base and Remotes).		
				(3) Network setting error	(3) This is a CC-Link station number setting error (factory preset). Specify the correct station number.
				(4) Number of registered Remotes error	(4) The number of registered Remotes has exceeded the set value. Change the operation mode of the Base. Delete the registrations of the Remotes (wireless channels) outside of the set range or change the wireless channels to valid channels.
				(5) Memory read/write error	(5) Internal memory read/write operations are not performed normally. Initialize the product.
		Red	ON	Base failure	Replace the Base. If the error persists after replacement, stop using the equipment and contact your SMC sales representative.
		-	OFF	Base turned OFF	Supply 24 VDC +/-10% for US1 (for control) power source.

Problem No.	LED name	LED status		Possible causes	Investigation and countermeasures
		Colour of LED	ON/Flashing		
4	W-SS	Red	Flashing	When Protocol V.1.0 is used (1) Remote power supply is OFF (2) Outside the wireless coverage area	(1) Supply 24 VDC +/-10% to the US1 (for control / input) power source of the Remote. (2) The distance which wireless communication between wireless systems can be established may have been exceeded. Reconsider the operating environment, such as the installation conditions, of the Base and Remote.
		Orange	Flashing	When Protocol V.2.0 is used (1) Remote power supply is OFF (2) Outside the wireless coverage area	(1) Supply 24 VDC +/-10% to the US1 (for control / input) power source of the Remote. (2) The distance which wireless communication between wireless systems can be established may have been exceeded. Reconsider the operating environment, such as the installation conditions, of the Base and Remote.
		-	OFF	Remote not registered	Check the registration status of the Remote and perform pairing correctly.
5	W-NS	Green	Flashing	(1) Some Remotes are not connected (2) Some registered Remotes have no wireless signal	(1) Supply 24 VDC +/-10% to the US1 (for control / input) power source of the Remote. (2) The distance which wireless communication between wireless systems can be established may have been exceeded. Reconsider the operating environment, such as the installation conditions, of the Base and Remote.
		Red	Flashing	(1) Power supply to all registered Remotes is OFF (2) All registered Remotes have no wireless signal	(1) Supply 24 VDC +/-10% to the US1 (for control / input) power source of the Remote. (2) The distance which wireless communication between wireless systems can be established may have been exceeded. Reconsider the operating environment, such as the installation conditions, of the Base and Remote.
		Red	ON	No Remotes are connected due to a failure of the Base	Replace the Base. If the error persists after replacement, stop using the equipment and contact your SMC sales representative.
		Red	Alternate Flashing	In pairing mode.	The system has been set to "Pairing enable". Change the setting to "Pairing disable" when pairing is not conducted.
		-	OFF	Remote not registered	Check the registration status of the wireless unit and conduct pairing with the Remote correctly.

Problem No.	LED name	LED status		Possible causes	Investigation and countermeasures
		Colour of LED	ON/Flashing		
6	W-MS	Red	Flashing	<p>The following Remote diagnostic information is detected.</p> <p>(1) US1 (for control) power supply voltage level is abnormal</p> <p>(2) US2 (for output) power supply voltage level is abnormal</p> <p>(3) Excessive I/O setting for inputs/outputs</p> <p>(4) Error in communication between units (4)-1 Abnormal input unit (4)-2 Abnormal output unit (4)-3 Abnormal input / output unit</p> <p>(5) EX600 I/O unit detects diagnostic information (5)-1 Short-circuited US1 (for control / input) power supply voltage (5)-2 Short-circuited US2 (for output) power supply voltage (5)-3 Short-circuited output load (5)-4 User set upper or lower limit of the analog unit exceeded (5)-5 I/O range upper or lower limit of the analog unit exceeded</p> <p>(6) Valve diagnostic information detected (6)-1 Valve short-circuited (6)-2 Valve with broken line</p>	<p>After checking the error contents while referring to the system diagnostic information and LED indication, refer to the following countermeasures.</p> <p>As this LED indicates the system status of the Remote, the following diagnoses can be conducted only when the diagnostic mapping is set to "Advanced".</p> <p>(1) Supply 24 VDC +/-10% to the US1 (for control / input) power source of the Remote.</p> <p>(2) Supply 24 VDC +/-10% to the US2 (for output) power source of the Remote</p> <p>(3) The number of the station's input / output points has exceeded the set value. Check the occupied bytes of the EX600 I/O unit and valve manifold connected to the Remote.</p> <p>(4) Confirm that there is no loose connection between the units and connect them correctly.</p> <p>(5) Check the part where the error occurs by checking the LED indication and information of the system diagnostics, and refer to the operation manual for the digital and analog units.</p> <p>(6) Replace the valve and check the operation.</p>
	W-MS	Red	ON	Remote malfunction	Replace the Remote If the error persists after replacement, stop using the equipment and contact your SMC sales representative.

Problem No.	LED name	LED status		Possible causes	Investigation and countermeasures
		Colour of LED	ON/Flashing		
7	LRUN	-	OFF	(1) Communication not established (2) The US1 (for control) power supply is OFF	(1) Set the station number, communication speed and operation mode correctly. (2) Supply 24 VDC +/-10% for US1 (for control) power source.
8	LERR	Red	ON	An error has occurred in communication with PLC	Check the following items and restart. (1) Check for looseness and broken lines of the connector. (2) Keep noise sources away from the communication line.

Problem No.	Phenomenon	Possible causes	Investigation and countermeasures
9	NFC communication error	NFC communication is not established (communication failure)	Check the following items and check the operation again. •Confirm that the settings of the NFC port and PaSoRi of the PC are correct. •Check that the specifications of the NFC reader / writer to be used are appropriate. •Confirm that the NFC reader / writer are connected correctly. •The communication distance is outside of the NFC range. Place the body (NFC antenna approach area) close to the NFC reader / writer.
		NFC reader/writer broken	Replace the NFC reader / writer and check the operation. If the error persists after replacement, stop using the equipment and contact your SMC sales representative.

•Remote I/O unit troubleshooting items

LED	Description	LED status		No.	
		Colour of LED	ON/Flashing		
-	All LEDs are OFF.	-		Problem 1	
PWR	PWR LED does not turn on green.	Red	Flashing	Problem 2	
		-	OFF		
MS	MS LED does not turn on green.	Red	Flashing	Problem 3	
		Red	ON		
		-	OFF		
W-SS	Red W-SS LED flashes or is OFF.	Red	Flashing	Problem 4	
		Orange	Flashing		
		-	OFF		
W-NS	W-NS LED does not turn on green.	Red	Flashing	Trouble 5	
		Orange	Flashing (1 Hz)		
		Red	ON		
		Red	Green		Alternate Flashing
		-	OFF		
Digital input /output device does not operate correctly.				Problem 6	
Problems related to the NFC				Problem 7	

•Remote troubleshooting

Trouble No.	LED Name	LED status		Possible causes	Investigation and countermeasures
		Colour of LED	ON/Flashing		
1	All	-	OFF	The US1 (for control / input) power supply is OFF	Supply 24 VDC +/-10% for US1 (for control / input) power source.
2	PWR	Red	Flashing	Reduction in the US2 (for output) power voltage (when the setting is enabled)	The power supply voltage of the US2 (for output) power supply is low. Supply 24 VDC +/-10%.
		-	OFF	The US1 (for control / input) power supply is OFF	Supply 24 VDC +/-10% for US1 (for control / input) power source.
3	MS	Red	Flashing	The following diagnostic information is detected.	After checking the error contents while referring to the system diagnostic information and LED indication, refer to the following countermeasures.
				(1) Short-circuit detection of the US1 power supply (for control / input)	(1) Re-wire the short-circuited part or check if the cable and input device are normal.
				(2) US1 (for control / input) power supply voltage level is abnormal (when the setting is enabled)	(2) The power supply voltage of the US1 (for control / input) power supply is low. Supply 24 VDC +/-10%.
				(3) Short-circuit detection of the US2 power supply (for output)	(3) Re-wire the short-circuited part or check if the cable and output device are normal
		Red	ON	Remote malfunction	Replace the Remote If the error persists after replacement, stop using the equipment and contact your SMC sales representative.
		-	OFF	The US1 (for control / input) power supply is OFF	Supply 24 VDC +/-10% for US1 (for control / input) power source.

Problem No.	LED Name	LED status		Possible causes	Investigation and countermeasures
		Colour of LED	ON/Flashing		
4	W-SS	Red	Flashing	When Protocol V.1.0 is used (1) Power supply for the Base is OFF (2) Outside the wireless coverage area	(1) Supply 24 VDC +/-10% for the US1 (for control) power source of the Base. (2) The distance which wireless communication between wireless systems can be established may have been exceeded. Reconsider the operating environment, such as the installation conditions, of the Base and Remote.
		Orange	Flashing	When Protocol V.2.0 is used (1) Power supply for the Base is OFF (2) Outside the wireless coverage area	(1) Supply 24 VDC +/-10% for the US1 (for control) power source of the Base. (2) The distance which wireless communication between wireless systems can be established may have been exceeded. Reconsider the operating environment, such as the installation conditions, of the Base and Remote.
		-	OFF	(1) Remote not registered (2) The US1 (for control / input) power supply is OFF	(1) Check the registration status of the Remote and perform pairing correctly. (2) Supply 24 VDC +/-10% for US1 (for control / input) power source.

Problem No.	LED Name	LED status		Possible causes	Investigation and countermeasures	
		Colour of LED	ON/Flashing			
5	W-NS	Red	Flashing	(1) Power supply for the Base is OFF (2) Outside the wireless coverage area	(1) Supply 24 VDC +/-10% for the US1 (for control) power source of the Base. (2) The distance which wireless communication between wireless systems can be established may have been exceeded. Reconsider the operating environment, such as the installation conditions, of the Base and Remote.	
		Red	ON	Remote malfunction	Replace the Remote If the error persists after replacement, stop using the equipment and contact your SMC sales representative.	
		Red	Green	Alternate Flashing	In pairing mode.	The system has been set to "Pairing enable". Change the setting to "Pairing disable" when pairing is not conducted.
		Orange	Flashing (1 Hz)	Fn (pairing button) in use	Fn is being used. Change the mode according to the application.	
		-	OFF	(1) Base not registered (2) The US1 (for control / input) power supply is OFF	(1) Check the registration status of the Remote and perform pairing correctly. (2) Supply 24 VDC +/-10% for US1 (for control / input) power source.	

Problem No.	Phenomenon	Possible causes	Investigation and countermeasures
6	Abnormal digital input device operation	Input type does not match.	If the polarities (PNP, NPN) of the Remote and digital input unit do not match, replace one of them to make the combination match.
		US1 (for control / input) power voltage drop	Supply a voltage of 24 VDC +/-10% to the US1 (for control / input) power source of the Remote.
		Wiring or connection is defective.	Connect the wiring between the Remote and the digital input equipment correctly.
		Remote malfunction	Replace the Remote and check the operation.
		Digital input equipment broken	Replace the digital input equipment and check the operation. Or refer to Troubleshooting for the applicable digital input equipment.
	Abnormal digital output equipment operation	Mismatched output type	If the polarities (PNP, NPN) of the Remote and digital output unit do not match, replace one of them to make the combination match.
		US2 (for output) power voltage drop	Supply 24 VDC +/-10% to the US2 (for output) power source of the Remote.
		Wiring or connection is defective.	Connect the wiring between the Remote and the digital output equipment correctly.
		Remote malfunction	Replace the Remote and check the operation.
		Digital output equipment broken	Replace the digital output equipment and check the operation. Or refer to Troubleshooting for the applicable digital output equipment.
Program error	Check that the ladder logic program works correctly.		

Problem No.	Phenomenon	Possible causes	Investigation and countermeasures
7	NFC communication error	NFC communication is not established (communication failure)	<p>Check the following items and check the operation again.</p> <ul style="list-style-type: none"> •Confirm that the settings of the NFC port and PaSoRi of the PC are correct. •Check that the specifications of the NFC reader / writer to be used are appropriate. •Confirm that the NFC reader / writer are connected correctly. •The communication distance is outside of the NFC range. Place the body (NFC antenna approach area) close to the NFC reader / writer.
		NFC reader/writer broken	<p>Replace the NFC reader / writer and check the operation. If the error persists after replacement, stop using the equipment and contact your SMC sales representative.</p>

Technical Information

I/O Map

The compact wireless Base uses an occupied area of a different size in accordance with the operation mode. Configure it with the number of wireless Remotes to be connected to it and the input/output size taken into consideration.

Operation Mode	Maximum number of remote registration units allowed by the system *1	CC-Link setting			Occupied area	
		CC-Link Version	Extended cyclic	Number of occupied stations	Bit area RX/RX (in bits) *2	Word area RWr/RWw (in words)
1	15	1.10	x1	2	64/64	8/8
2	15	1.10	x1	4	128/128	16/16
3	15	2.00	x8	2	384/384	64/64
4	15	2.00	x8	4	896/896	128/128
5	31	2.00	x8	2	384/384	64/64
6	31	2.00	x8	4	896/896	128/128
7	63	2.00	x8	4	896/896	128/128
8	127	2.00	x8	4	896/896	128/128

*1 The actual number of units that can be registered depends on the operation mode and remote type.

*2 The last register of the Bit area (16 bits) cannot be used as it is allocated for the system area.

Example) If the size of the Bit area is 896/896, the actual available size is 880/880.

The table below shows the effective number of occupied bits for each input/output unit (including EX600 series) which can be connected to the Base and Remotes.

The allocated input/output sizes can be changed depending on the occupied bytes of the diagnostic mapping and the EX600 I/O unit connected to the wireless unit.

Refer to the table below for the number of input/output bits for each unit.

EXW1-series

Unit name	Model	Unit product no.	Bit area	
			Input (RX)	Output (RY)
Compact wireless Remote	RDX	EXW1-RDX* (16 points)	16	0
	RDY	EXW1-RDY* (16 points)	0	16
	RDM	EXW1-RDM* (8 points)	16*1	16*1

*1: The number of inputs/outputs is fixed at 16 (16 bits), and only the lower 8 bits are valid.

EX600-W Series

Unit name	Model	Unit product no.	Bit area	
			Input (RX)	Output (RY)
Wireless Remote	WSV	EX600-WSV* (32 points)	0	32
		EX600-WSV* (24 points)	0	24
		EX600-WSV* (16 points)	0	16
		EX600-WSV* (8 points)	0	8
		EX600-WSV* (0 points)	0	0
Digital input unit (EX600 Series)	DX	EX600-DX *B (8 points)	8	0
		EX600-DX *C (8 points)	8	0
		EX600-DX *C1 (8 points) (with broken line detection)	8	0
		EX600-DX *D (16 points)	16	0
		EX600-DX *E (16 points)	16	0
		EX600-DX *F (16 points)	16	0
Digital output unit (EX600 Series)	DY	EX600-DY *B (8 points)	0	8
		EX600-DY *E (16 points)	0	16
		EX600-DY *F (16 points)	0	16
Digital I/O unit (EX600 Series)	DM	EX600-DM *E (8/8 points)	8	8
		EX600-DM *F (8/8 points)	8	8
Analog input unit	AX	EX600-AXA*1 (2 points)	32	0
Analog output unit	AY	EX600-AYA*1 (2 points)	0	32
Analog I/O unit	AM	EX600-AMB*1 (2/2 points)	32	32

*1: User set minus ranges are not supported.

I/O Mapping

The occupied areas (Bit and Word areas) of EXW1-BMJA* are fixed depending on the operation mode. Configure the product with the number of wireless Remotes to be connected to it and the input/output size taken into consideration.

The Remote I/O map is stored in the bit area, and diagnostic information is stored in the Word area. The mapping order is decided Based on the wireless channels during Remote registration.

As they are allocated from the smallest registered channel number, channels in which no Remote is registered will be ignored. (See the figure below.)

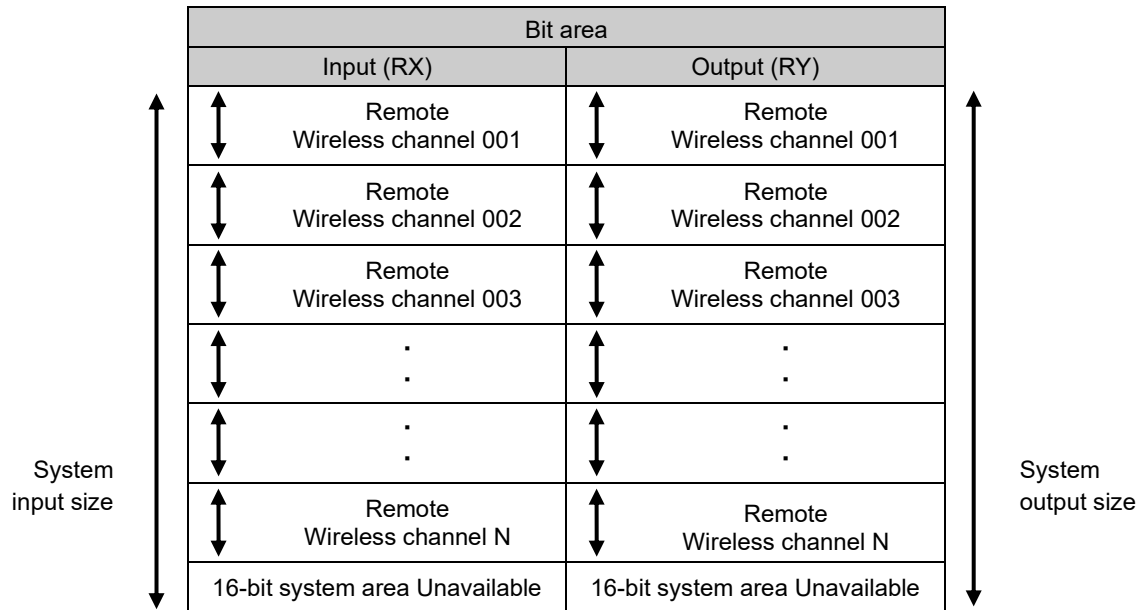

Diagnostics Mapping

The mapping of system diagnostic and Remote connection/diagnostic/registration information is as shown below (Remote registration: 127 Remotes).

Resister area	Upper bytes	Lower bytes
	Reserved	Reserved
0	Reserved	Reserved
1	System diagnosis 2	System diagnosis 1
2	System diagnosis 4	System diagnosis 3
3	Remote connection information (Wch: 8-15)	Remote connection information (Wch: 1-7) ^{*1}
4	Remote connection information (Wch: 24-31)	Remote connection information (Wch: 16-23)
⋮	⋮	⋮
9	Remote connection information (Wch: 104-111)	Remote connection information (Wch: 96-103)
10	Remote connection information (Wch: 120-127)	Remote connection information (Wch: 112-119)
11	Remote diagnostic information (Wch: 8-15)	Remote diagnostic information (Wch: 1-7) ^{*2}
12	Remote diagnostic information (Wch: 24-31)	Remote diagnostic information (Wch: 16-23)
⋮	⋮	⋮
17	Remote diagnostic information (Wch: 104-111)	Remote diagnostic information (Wch: 96-103)
18	Remote diagnostic information (Wch: 120-127)	Remote diagnostic information (Wch: 112-119)
19	Remote registration information (Wch: 8-15)	Remote registration information (Wch: 1-7) ^{*1}
20	Remote registration information (Wch: 24-31)	Remote registration information (Wch: 16-23)
⋮	⋮	⋮
25	Remote registration information (Wch: 104-111)	Remote registration information (Wch: 96-103)
26	Remote registration information (Wch: 120-127)	Remote registration information (Wch: 112-119)

*1: The bit0 of connection/registration information is fixed at "0".

*2: The bit0 of diagnostic information indicates the diagnostic information of the Base.

I/O Mapping Order When EX600-WSV* is Paired

Please note that when EXW1-BMJA* and EX600-WSV* are paired, the mapping order of the EX600 I/O unit and the valve manifold connected to the Remote is different depending on the I/O unit layout mode in the Remote parameter setting. Refer to the operation manual of EX600-W Series for details on the I/O unit mapping order when an EX600-W Series unit is paired.

Mode 1: **Mapping to the right from the end plate**

Mode 2: **Mapping to the left from the wireless unit**

I/O and diagnostic mapping examples in mode 1 and mode 2 are shown below.

- The compact wireless Base (EXW1-BMJA*) is in operation mode 2.
- Number of connected units: 15, Bit area RX/Ry: 128/128, Word area RWr/RWw: 16/16

<Example 1>

- I/O mapping order Mode 1

	Unit 0	Unit 1	Unit 2	Unit 3	
End plate	DY□B	AXA	DX□D	EX600-WSV*	Valve manifold
	Digital output	Analog input	Digital input	Remote 32 bit Output	(32 points)
	8 bit Output	32 bit input	16 bit input		

Remote setting parameters values
(Wireless channel 001)

Module input size: 64 points / 64 bits
Module output size: 48 points / 48 bits
Valve manifold output size: 32 points / 32 bits
I/O unit layout mode: Mode 1

Remote configuration (Wireless channel "001")

Input data: [Unit 1] Analog input unit (EX600-AXA): 32 bits occupied
[Unit 2] Digital input unit (EX600-DX*D): 16 bits occupied
Output data: [Unit 0] Digital output unit (EX600-DY*B): 8 bits occupied
[Unit 3] Remote (EX600-WSV*): 32 bits occupied

	Unit 0	Unit 1	Unit 2	Unit 3	
End plate	DY□B	DX□D	DX□B	EX600-WSV*	End plate
	Digital output	Digital input	Digital input	Remote	(Output side)
	8 bit Output	16 bit input	8 bit input	0 bit Output	

Remote setting parameters values
(Wireless channel 002)

Module input size: 32 points / 32 bits
Module output size: 16 points / 16 bits
Valve manifold output size: 0 points / 0 bits
I/O unit layout mode: Mode 1

Remote configuration (Wireless channel "002")

Input data: [Unit 1] Digital input unit (EX600-DX*D): 16 bits occupied
[Unit 2] Digital input unit (EX600-DX*B): 8 bits occupied
Output data: [Unit 0] Digital output unit (EX600-DY*B): 8 bits occupied
[Unit 3] Remote (EX600-WSV*): 0 bits occupied

I/O mapping order Mode 1: I/O map

RX/RX	Input data		Output data	
	Module name	Unit name	Module name	Unit name
Byte0	Remote Wireless channel "001"	AXA (Unit 1)	Remote Wireless channel "001"	DY*B (Unit 0)
Byte1				EX600-WSV* (Unit 3) 32 valve outputs
Byte2				
Byte3				
Byte4		DX*D (Unit 2)		
Byte5		Reserved	Remote Wireless channel "002"	Reserved
Byte6		Reserved		DY*B (Unit 0)
Byte7		Reserved		Reserved
Byte8	Remote Wireless channel "002"	DX*D (Unit 1)	Reserved	
Byte9			Reserved	
Byte10		DX*B (Unit 2)	Reserved	
Byte11		Reserved	Reserved	
Byte12	Reserved		Reserved	
Byte13	Reserved		Reserved	
Byte14	Reserved (system area)		Reserved (system area)	
Byte15	Reserved (system area)		Reserved (system area)	
Total	16 bytes		16 bytes	

<Example 2>

●I/O mapping order Mode 2

	Unit 3	Unit 2	Unit 1	Unit 0	
	DY□B	AXA	DX□D	EX600-WSV*	
End plate	Digital output	Analog input	Digital input	Remote	Valve manifold
	8 bit output	32 bit input	16 bit input	32 bit output	(32 points)

Remote setting parameters values
(Wireless channel 001)

Module input size: 64 points / 64 bits
Module output size: 48 points / 48 bits
Manifold output size: 32 points / 32 bits
I/O unit layout mode: Mode 2

Remote configuration (Wireless channel "001")

Input data: [Unit 1] Digital input unit (EX600-DX*D): 16 bits occupied

[Unit 2] Analog input unit (EX600-AXA): 32 bits occupied

Output data: [Unit 0] Remote (EX600-WSV*): 32 bits occupied

[Unit 3] Digital output unit (EX600-DY*B): 8 bits occupied

	Unit 3	Unit 2	Unit 1	Unit 0	
	DY□B	DX□D	DX□B	EX600-WSV*	
End plate	Digital output	Digital input	Digital input	Remote	End plate
	8 bit output	16 bit input	8 bit input	0 bit output	(Output side)

Remote setting parameters values
(Wireless channel 002)

Module input size: 32 points / 32 bits
Module output size: 16 points / 16 bits
Valve manifold output size: 0 points / 0 bits
I/O unit layout mode: Mode 2

Remote configuration (Wireless channel "002")

Input data: [Unit 1] Digital input unit (EX600-DX*B): 8 bits occupied

[Unit 2] Digital input unit (EX600-DX*D): 16 bits occupied

Output data: [Unit 0] Remote (EX600-WSV*): 0 bits occupied

[Unit 3] Digital output unit (EX600-DY*B): 8 bits occupied

I/O mapping order Mode 2: I/O map

RX/Ry	Input data		Output data	
	Module name	Unit name	Module name	Unit name
Byte0	Remote Wireless channel "001"	DX*D (Unit 1)	Remote Wireless channel "001"	EX600-WSV* (Unit 0) 32 valve outputs
Byte1				
Byte2				
Byte3		AXA (Unit 2)		DY*B (Unit 3)
Byte4				
Byte5		Reserved		Reserved
Byte6				
Byte7	Remote Wireless channel "002"	DX*B (Unit 1)	Reserved	
Byte8		DX*D (Unit 2)	Reserved	
Byte9			Reserved	
Byte10		Reserved		
Byte11	Reserved	Reserved		
Byte12	Reserved		Reserved	
Byte13	Reserved		Reserved	
Byte14	Reserved (system area)		Reserved (system area)	
Byte15	Reserved (system area)		Reserved (system area)	
Total	16 bytes		16 bytes	

Diagnostics map (common to modes 1 and 2)

Resister area	Upper bytes	Lower bytes	
RWr	0	Reserved	Reserved
	1	System diagnosis 2	System diagnosis 1
	2	System diagnosis 4	System diagnosis 3
	3	Remote connection information (Wch: 8-15)	Remote connection information (Wch: 1-7)
	4	Remote diagnostic information (Wch: 8-15)	Remote diagnostic information (Wch: 1-7)
	5	Remote registration information (Wch: 8-15)	Remote registration information (Wch: 1-7)
	6	Reserved	Reserved
	⋮	⋮	⋮
	15	Reserved	Reserved

I/O Mapping Order When EX600-WEN* or EX600-WPN* is Paired

Please note that, when EX600-WEN/WPN* and EXW1-RD* are paired, the mapping order of EX600 I/O unit and the valve manifold connected to the Base is different depending on the I/O unit layout mode in the Base parameter setting. Refer to the operation manual of EX600-W Series for details on the I/O unit mapping order when an EX600-W Series unit is paired.

Mode 1: **Mapping to the right from the end plate**

Mode 2: **Mapping to the left from the wireless unit**

I/O and diagnostic mapping examples in mode 1 and mode 2 are shown below.

<Example 1>

●Mode 1

	Unit 0	Unit 1	Unit 2	
	DY□B	DX□D	EX600-WEN*	
End plate	Digital output	Digital input	Base	Valve manifold
	1 byte output	2 byte input	2 byte output	(16 points)

Base setting parameters values

Diagnostic mapping: None / Simple / Advanced
 I/O mapping: Auto
 Module input size: 32 points / 4 bytes
 Module output size: 32 points / 4 bytes
 Valve manifold output size:
 16 points / 2 bytes
 I/O unit layout mode: Mode 1
 Number of registered Remotes: 15

Base configuration

Input data: [Unit 1] Digital input unit (EX600-DY*D): 2 bytes occupied
 Output data: [Unit 0] Digital output unit (EX600-DY*B): 1 byte occupied
 [Unit 2] Base (EX600-WEN*): 2 bytes occupied

EXW1-RDX*
Digital input
2 bytes

Remote setting parameters values
 (Wireless channel 001)
 Module input size: 16 points / 2 bytes
 Module output size: 0 points / 0 bytes

Remote configuration (Wireless channel "001")

Input data: EXW1-RDX* 2 bytes occupied

EXW1-RDY*
Digital output
2 bytes

Remote setting parameters values
 (Wireless channel 002)
 Module input size: 0 points / 0 bytes
 Module output size: 16 points / 2 bytes

Remote configuration (Wireless channel "001")

Output data: EXW1-RDY* 2 bytes occupied

EXW1-RDM*
Digital input/output
Input/output 2 bytes each

Remote setting parameters values
 (Wireless channel 003)
 Module input size: 16 points / 2 bytes
 Module output size: 16 points / 2 bytes

Remote configuration (Wireless channel "003")

Input data: EXW1-RDM* 2 bytes occupied

Output data: EXW1-RDM* 2 bytes occupied

* The number of inputs/outputs of EXW1-RDM* is fixed at 16 (16 bits), and only the lower 8 bits are valid.

•Diagnostic mapping: None

	Input data		Output data			
	Module name	Unit name	Module name	Unit name		
Byte0	Base	DX*D (Unit 1)	Base	DY*B (Unit 0)		
Byte1				Reserved	EX600-WEN* (Unit 2) Valve output: 16 points	
Byte2		Reserved			Reserved	
Byte3				Remote	Remote	EXW1-RDY*
Byte4	Wireless channel "001"	EXW1-RDX*	Wireless channel "002"			
Byte5	Remote	EXW1-RDM*	Remote	EXW1-RDM*		
Byte6					Wireless channel "003"	Wireless channel "003"
Byte7						
Total	8 bytes		8 bytes			

•Diagnostic mapping: Simple

	Input data		Output data			
	Module name	Unit name	Module name	Unit name		
Byte0	System diagnosis 1		Base	DY*B (Unit 0)		
Byte1	System diagnosis 2			EX600-WEN* (Unit 2) Valve output: 16 points		
Byte2	System diagnosis 3			Reserved		
Byte3	System diagnosis 4			Remote	EXW1-RDY*	
Byte4	Base	DX*D (Unit 1)	Wireless channel "002"	EXW1-RDY*		
Byte5					Reserved	Remote
Byte6		Reserved	Wireless channel "003"			
Byte7					Remote	EXW1-RDX*
Byte8	Wireless channel "001"	EXW1-RDX*				
Byte9	Remote	EXW1-RDM*				
Byte10					Wireless channel "003"	EXW1-RDM*
Byte11						
Total	12 bytes		8 bytes			

•Diagnostic mapping: Advanced

	Input data		Output data			
	Module name	Unit name	Module name	Unit name		
Byte0	System diagnosis 1		Base	DY*B (Unit 0)		
Byte1	System diagnosis 2			EX600-WEN* (Unit 2) Valve output: 16 points		
Byte2	System diagnosis 3			Reserved		
Byte3	System diagnosis 4					
Byte4	Remote connection information (Wireless channels 1-7; bit0 is fixed at "0".)		Remote Wireless channel "002"	EXW1-RDY*		
Byte5	Remote connection information (Wireless channels 8-15)					
Byte6	Remote diagnostic information*1 (Wireless channels 1-7)		Remote Wireless channel "003"	EXW1-RDM*		
Byte7	Remote diagnostic information (Wireless channels 8-15)					
Byte8	Remote registration information (Wireless channels 1-7; bit0 is fixed at "0".)					
Byte9	Remote registration information (Wireless channels 8-15)					
Byte10	Base	DX*D (Unit 1)				
Byte11		Reserved				
Byte12		Reserved				
Byte13		Reserved				
Byte14	Remote Wireless channel "001"	EXW1-RDX*				
Byte15		EXW1-RDX*				
Byte16	Remote Wireless channel "003"	EXW1-RDM*				
Byte17		EXW1-RDM*				
Total	18 bytes				8 bytes	

Note) When diagnostic mapping is set to "Advanced", a portion of the area is occupied for the number of Remotes specified using the number of registered Remote setting.

(The occupied area also occupies the area for Remotes which has not been registered.)

*1: The bit0 of Remote diagnostic information indicates the diagnostic information of the Base.

<Example 2>

●Mode 2

	Unit 2	Unit 1	Unit 0	
End plate	DY□B Digital output 1 byte output	DX□D Digital input 2 byte input	EX600-WEN* Base 2 byte output	Valve manifold (16 points)

Base configuration

Input data: [Unit 1] Digital input unit (EX600-DY*D): 2 bytes occupied
 Output data: [Unit 0] Base (EX600-WEN*): 2 bytes occupied
 [Unit 2] Digital output unit (EX600-DY*B): 1 byte occupied

Base setting parameters values

Diagnostic mapping: None / Simple / Advanced
 I/O mapping: Auto
 Module input size: 32 points / 4 bytes
 Module output size: 32 points / 4 bytes
 Valve manifold output size:
 16 points / 2 bytes
 I/O unit layout mode: Mode 2
 Number of registered Remotes: 15

EXW1-RDX* Digital input 2 byte

Remote setting parameters values (Wireless channel 001) Module input size: 16 points / 2 bytes Module output size: 0 points / 0 bytes
--

Remote configuration (Wireless channel "001")

Input data: EXW1-RDX* 2 bytes occupied

EXW1-RDY* Digital output 2 byte

Remote setting parameters values (Wireless channel 002) Module input size: 0 points / 0 bytes Module output size: 16 points / 2 bytes
--

Remote configuration (Wireless channel "001")

Output data: EXW1-RDY* 2 bytes occupied

EXW1-RDM* Digital input/output Input/output 2 bytes each

Remote setting parameters values (Wireless channel 003) Module input size: 16 points / 2 bytes Module output size: 16 points / 2 bytes

Remote configuration (Wireless channel "003")

Input data: EXW1-RDM* 2 bytes occupied

Output data: EXW1-RDM* 2 bytes occupied

* The number of inputs and outputs of EXW1-RDM* is fixed at 16 (16 bits), and only the lower 8 bits are valid.

•Diagnostic mapping: None

	Input data		Output data	
	Module name	Unit name	Module name	Unit name
Byte0	Base	DX*D (Unit 1)	Base	EX600-WEN* (Unit 0) Valve output: 16 points
Byte1				
Byte2		Reserved		DY*B (Unit 2)
Byte3		Reserved		
Byte4	Remote	EXW1-RDX*	Remote	EXW1-RDY*
Byte5	Wireless channel "001"		Wireless channel "002"	
Byte6	Remote	EXW1-RDM*	Remote	EXW1-RDM*
Byte7	Wireless channel "003"		Wireless channel "003"	
Total	8 bytes		8 bytes	

•Diagnostic mapping: Simple

	Input data		Output data	
	Module name	Unit name	Module name	Unit name
Byte0	System diagnosis 1		Base	EX600-WEN* (Unit 0) Valve output: 16 points
Byte1	System diagnosis 2			
Byte2	System diagnosis 3			DY*B (Unit 2)
Byte3	System diagnosis 4			Reserved
Byte4	Base	DX*D (Unit 1)	Remote	EXW1-RDY*
Byte5			Wireless channel "002"	
Byte6		Reserved	Remote	EXW1-RDM*
Byte7		Reserved	Wireless channel "003"	
Byte8	Remote	EXW1-RDX*	/	
Byte9	Wireless channel "001"			
Byte10	Remote	EXW1-RDM*		
Byte11	Wireless channel "003"			
Total	12 bytes		8 bytes	

•Diagnostic mapping: Advanced

	Input data		Output data			
	Module name	Unit name	Module name	Unit name		
Byte0	System diagnosis 1		Base	EX600-WEN* (Unit 0) Valve output: 16 points		
Byte1	System diagnosis 2			DY*B (Unit 2)		
Byte2	System diagnosis 3			Reserved		
Byte3	System diagnosis 4					
Byte4	Remote connection information (Wireless channels 1-7; bit0 is fixed at "0".)		Remote Wireless channel "002"	EXW1-RDY*		
Byte5	Remote connection information (Wireless channels 8-15)					
Byte6	Remote diagnostic information*1 (Wireless channels 1-7)		Remote Wireless channel "003"	EXW1-RDM*		
Byte7	Remote diagnostic information (Wireless channels 8-15)					
Byte8	Remote registration information (Wireless channels 1-7; bit0 is fixed at "0".)					
Byte9	Remote registration information (Wireless channels 8-15)					
Byte10	Base	DX*D (Unit 1)				
Byte11		Reserved				
Byte12		Reserved				
Byte13		Reserved				
Byte14	Remote Wireless channel "001"	EXW1-RDX*				
Byte15		EXW1-RDM*				
Byte16	Remote Wireless channel "003"	EXW1-RDM*				
Byte17						
Total	18 bytes				8 bytes	

Note) When diagnostic mapping is set to "Advanced", a portion of the area is occupied for the number of Remotes specified using the

number of registered Remote setting.

(The occupied area also occupies the area for Remotes which has not been registered.)

*1: The bit0 of Remote diagnostic information indicates the diagnostic information of the Base.

Diagnostics map details

When an error occurs in the Base or Remote, a flag will be set in a Bit corresponding to each item of diagnostic information.

The errors for the system diagnostics 1 to 4 are for the entire system. Therefore, even if there is only one unit which has an error in the constructed system, a flag will be set in a Bit corresponding to the error content.

It is possible to identify the abnormal Remote using the Remote diagnostic information.

(It is necessary to set the diagnostic mapping to "Advanced".)

Regardless of the setting of the diagnostic mapping, the abnormal module and unit can be identified using the I/O Configurator provided by SMC.

The following table is for a system that uses EXW1-BMJA* as the Base. To use EX600-WEN/WPN*, refer to the operation manual for the Base in use.

Item	Resister area	Bit No.	Content of diagnostics		Diagnosed area and processing upon error		How to reset	Reset conditions	Remarks (LED indications, etc.)
			Item	Details	Effective diagnostic coverage	I/O processing upon diagnosis			
System diagnosis 1	RWr1	0	User setting lower level detection	Detected that the analog setting has exceeded the lower limit of the user set value.	Unit	Continue	Automatic reset	Select an appropriate range so that they are within the user set value range. Or disable the diagnostics.	Base W-MS: Flashes red ¹⁾ Remote MS: Flashes red
		1	User setting upper limit detection	Detected that the analog setting has exceeded the upper limit of the user set value.	Unit	Continue	Automatic reset	Select an appropriate range so that they are within the user set value range. Or disable the diagnostics.	
		2	Detection of the range lower limit	Detected that the analog setting has exceeded the lower limit of the setting range.	Unit	Continue	Automatic reset	Select an appropriate range so that the input value is within the set range.	
		3	Detection of the range upper limit	Detected that the analog setting has exceeded the upper limit of the setting range.	Unit	Continue	Automatic reset	Select an appropriate range so that the input value is within the set range.	
		4	Detection of upper limit of ON/OFF operation cycle	The number of ON/OFF operating cycles has exceeded the upper limit of the setting value.	Unit	Continue	Automatic reset	Reset the ON/OFF cycles to zero. Or disable the diagnostics.	
		5	Detection of unconnected load	Detects the broken wire.	Unit	Continue	Manual/automatic reset	(1) Replace the valve or the input/output equipment, and check the operation. (2) Replace the valve or the output equipment, and check the operation.	

Item	Resister area	Bit No.	Content of diagnostics		Diagnosed area and processing upon error		How to reset	Reset conditions	Remarks (LED indications, etc.)
			Item	Details	Effective diagnostic coverage	I/O processing upon diagnosis			
System diagnosis 1	RWr1	6	Short-circuit detection of output load	A short-circuit of the valve or the output equipment has been detected.	Unit	Continue	Manual/automatic reset	(1) Replace the valve or the output equipment, and check the operation. (2) Replace the valve or the output equipment, and check the operation.	W-MS: Flashes red ¹ Remote MS: Flashes red
		7	Short-circuit detection of power supply for control / input	A short-circuit of the input equipment power supply has been detected.	Unit	Continue	Automatic reset	Check the part which has been causing the error and review the wiring or check if the input equipment is normal.	
8		Detection of a reduction in the US2 (for output) power voltage	A voltage drop of the US2 (for output) power supply voltage has been detected.	Unit	Continue	Automatic reset	Supply 24 VDC +/-10% for the US2 (for output) power supply voltage.	Base W-MS: Flashes red Remote (EXW1) PWR: Flashes red Remote (EX600-W) PWR(V): Flashes red	
9		Detection of a reduction in the US1 (for control / input) power voltage	A voltage drop of the US1 (for control / input) power supply voltage has been detected.	Unit	Continue	Automatic reset	Supply 24 VDC +/-10% for the US1 (for control / input) power supply voltage.	Base MS: Flashes red or W-MS: Flashes red Remote MS: Flashes red	
10		Reserved	-	-	-	-	-	-	-
System diagnosis 2		11	Connection failure between units (during operation)	An error has occurred in the communication between the wireless unit and EX600 I/O units.	Unit	Stop (HOLD)	Turn the power on again.	Confirm that there is no loose connection between the EX600 I/O units, and connect them correctly.	Base W-MS: Flashes red Remote (EX600-W) MS: Flashes red

Item	Resister area	Bit No.	Content of diagnostics		Diagnosed area and processing upon error		How to reset	Reset conditions	Remarks (LED indications, etc.)
			Item	Details	Effective diagnostic coverage	I/O processing upon diagnosis			
System diagnosis 2	RWr1	12	Connection failure between units (when power is supplied)	An error has occurred in the communication between the wireless unit and EX600 I/O units.	Unit	Stop (HOLD)	Turn the power on again.	Confirm that there is no loose connection between the EX600 I/O units, and connect them correctly.	Base W-MS: Flashes red Remote (EX600-W) MS: Flashes red
		13	Reserved	-	-	-	-	-	-
		14	Detection of system error (when power is supplied)	An unrecoverable error has occurred in the system.	Unit	Stop (HOLD)	Manual reset	Supply power again. If the error persists after resupplying power, contact your SMC sales representative.	Base MS: Lights up red Remote MS: Lights up red
		15	Detection of hardware error (during operation)	An unrecoverable error has occurred in the hardware.	Unit	Stop (HOLD)	Manual reset	Supply power again. If the error is not restored after resupplying power, contact your SMC sales representative.	Base MS: Lights up red or W-MS: Lights up red Remote MS: Lights up red
System diagnosis 3	RWr2	0	Number of inputs/outputs setting error	The number of occupied inputs/outputs of the Remote has exceeded the set value.	System	Continue	Manual reset	Change the user set value. Or, adjust the unit configuration so that the number of occupied points is within the set value.	Base W-MS: Flashes red Remote MS: Flashes red
		1	Reserved	-	-	-	-	-	-
		2	Reserved	-	-	-	-	-	-
		3	Reserved	-	-	-	-	-	-
		4	Reserved	-	-	-	-	-	-
		5	Reserved	-	-	-	-	-	-
		6	System Error detected	Memory read/write error	System	Continue	Manual reset	Initialize the product. If the error persists after resupplying power, contact your SMC sales representative.	Base, Remote MS: Flashes red
7	Detection of hardware error	Memory write error	System	Continue	Manual reset	Initialize the product. If the error persists after resupplying power, contact your SMC sales representative.	Base, Remote MS: Flashes red		

Item	Resister area	Bit No.	Content of diagnostics		Diagnosed area and processing upon error		How to reset	Reset conditions	Remarks (LED indications, etc.)
			Item	Details	Effective diagnostic coverage	I/O processing upon diagnosis			
System diagnosis 4	RWr2	8	Number of system inputs/outputs setting error	The number of occupied system inputs/outputs has exceeded the set value.	System	Continue	Manual reset	Change the user set value. Or, adjust the unit configuration so that the number of occupied points is within the set value.	Base MS: Flashes red
		9	Number of registered Remotes setting error (Outside of the wireless channel setting range)	More wireless channels than specified in the number of registered Remotes setting are registered.	System	Continue	Manual reset	Change the set value of the number of registered Remotes. Or, delete the registered Remotes (wireless channels) outside of the set range.	Base MS: Flashes red
		10	Reserved	-	-	-	-	-	-
		11	Reserved	-	-	-	-	-	-
		12	Network setting error	Upper communication is not established	System	Stop (HOLD)	Manual reset	Set the station number correctly.	Base MS: Flashes red or L ERR: Lights up red
		13	Reserved	-	-	-	-	-	-
		14	Wireless registration data corrupted	An error has occurred in the wireless registration information.	System	Stop (HOLD)	Manual reset	Supply power again. If the error persists after resupplying power, contact your SMC sales representative.	Base MS: Lights up red or W-NS: Lights up red
		15	Detection of wireless hardware error	An unrecoverable error has occurred in the hardware of the wireless units.	System	Stop (HOLD)	Manual reset	Supply power again. If the error persists after resupplying power, contact your SMC sales representative.	Base MS: Lights up red or W-NS: Lights up red

Item	Resister area	Bit No.	Content of diagnostics		Diagnosed area and processing upon error		How to reset	Reset conditions	Remarks (LED indications, etc.)
			Item	Details	Effective diagnostic coverage	I/O processing upon diagnosis			
Remote connection information Wireless channels 1-7 (Bit 0 is fixed at "0".)	RWr3	0	-		-	-	-	-	When the connection data is "0", the wireless communication with the Remote is not connected. When the connection data is "1", the wireless communication with the Remote is connected normally.
		1	Connection condition of the Remote communication (Wireless channel 1)		-	-	-	-	
		2	Connection condition of the Remote communication (Wireless channel 2)		-	-	-	-	
		3	Connection condition of the Remote communication (Wireless channel 3)		-	-	-	-	
		4	Connection condition of the Remote communication (Wireless channel 4)		-	-	-	-	
		5	Connection condition of the Remote communication (Wireless channel 5)		-	-	-	-	
		6	Connection condition of the Remote communication (Wireless channel 6)		-	-	-	-	
7		Connection condition of the Remote communication (Wireless channel 7)		-	-	-	-		
Remote connection information Wireless channels 8-15		8	Connection condition of the Remote communication (Wireless channel 8)		-	-	-	-	
		9	Connection condition of the Remote communication (Wireless channel 9)		-	-	-	-	
		10	Connection condition of the Remote communication (Wireless channel 10)		-	-	-	-	
		11	Connection condition of the Remote communication (Wireless channel 11)		-	-	-	-	
		12	Connection condition of the Remote communication (Wireless channel 12)		-	-	-	-	
		13	Connection condition of the Remote communication (Wireless channel 13)		-	-	-	-	
		14	Connection condition of the Remote communication (Wireless channel 14)		-	-	-	-	
	15	Connection condition of the Remote communication (Wireless channel 15)		-	-	-	-		

Item	Resister area	Bit No.	Content of diagnostics		Diagnosed area and processing upon error		How to reset	Reset conditions	Remarks (LED indications, etc.)
			Item	Details	Effective diagnostic coverage	I/O processing upon diagnosis			
Remote diagnostic information Wireless channels 1-7 (Bit 0 is for Base)	RWr4	0	Presence / absence of system information error of Base		-	-	-	-	No error in the Base / Remote when the diagnostic data is "0". Error in the Base / Remote when the diagnostic data is "1".
		1	Presence / absence of system information error of Remote (Wireless channel 1)		-	-	-	-	
		2	Presence / absence of system information error of Remote (Wireless channel 2)		-	-	-	-	
		3	Presence / absence of system information error of Remote (Wireless channel 3)		-	-	-	-	
		4	Presence / absence of system information error of Remote (Wireless channel 4)		-	-	-	-	
		5	Presence / absence of system information error of Remote (Wireless channel 5)		-	-	-	-	
		6	Presence / absence of system information error of Remote (Wireless channel 6)		-	-	-	-	
Remote diagnostic information Wireless channels 8-15	RWr4	7	Presence / absence of system information error of Remote (Wireless channel 7)		-	-	-	-	
		8	Presence / absence of system information error of Remote (Wireless channel 8)		-	-	-	-	
		9	Presence / absence of system information error of Remote (Wireless channel 9)		-	-	-	-	
		10	Presence / absence of system information error of Remote (Wireless channel 10)		-	-	-	-	
		11	Presence / absence of system information error of Remote (Wireless channel 11)		-	-	-	-	
		12	Presence / absence of system information error of Remote (Wireless channel 12)		-	-	-	-	
		13	Presence / absence of system information error of Remote (Wireless channel 13)		-	-	-	-	
		14	Presence / absence of system information error of Remote (Wireless channel 14)		-	-	-	-	
		15	Presence / absence of system information error of Remote (Wireless channel 15)		-	-	-	-	

Item	Resister area	Bit No.	Content of diagnostics		Diagnosed area and processing upon error		How to reset	Reset conditions	Remarks (LED indications, etc.)
			Item	Details	Effective diagnostic coverage	I/O processing upon diagnosis			
Remote registration information Wireless channels 1-7 (Bit 0 is fixed at "0".)	RWr5	0	-		-	-	-	-	When the registration data is "0", no Remote has been registered.
		1	Registration of Remote (Wireless channel 1)		-	-	-	-	
		2	Registration of Remote (Wireless channel 2)		-	-	-	-	
		3	Registration of Remote (Wireless channel 3)		-	-	-	-	
		4	Registration of Remote (Wireless channel 4)		-	-	-	-	
		5	Registration of Remote (Wireless channel 5)		-	-	-	-	
		6	Registration of Remote (Wireless channel 6)		-	-	-	-	
Remote registration information Wireless channels 8-15	RWr5	7	Registration of Remote (Wireless channel 7)		-	-	-	-	When the registration data is "1", a Remote has been registered.
		8	Registration of Remote (Wireless channel 8)		-	-	-	-	
		9	Registration of Remote (Wireless channel 9)		-	-	-	-	
		10	Registration of Remote (Wireless channel 10)		-	-	-	-	
		11	Registration of Remote (Wireless channel 11)		-	-	-	-	
		12	Registration of Remote (Wireless channel 12)		-	-	-	-	
		13	Registration of Remote (Wireless channel 13)		-	-	-	-	
		14	Registration of Remote (Wireless channel 14)		-	-	-	-	
15	Registration of Remote (Wireless channel 15)		-	-	-	-			

*1: The LED indicator W-MS indicates the system status of the Remote.

If it is ON or flashes, errors have occurred in the registered Remote.

*: When the diagnostic data of the system diagnostics 1-4 is "0", no error has occurred. When it is "1", errors have occurred.

*: This table is for when the number of registered Remotes is set to 15 in the Base settings.

The diagnostic sizes of Remote connection information, diagnostic information and registration information vary depending on the setting for the number of registered wireless units.

Number of remote registrations

The maximum number of remote units that can be registered is 127, but the actual number of units that can be registered is limited to the total of the module input/output point values of all remote units being within the maximum effective point value (maximum points - management area 16 points) and within the system upper limit for the number of remote units that can be registered.

- Example of the number of units that can be registered for EXW1-RD*E4* Remote or EXW1-RD*E3* Remote

Operation Mode	Maximum number of remote registration units allowed by the system	Occupied area		Maximum number of remotes in an occupied area (theoretical)			Number of remote units that can be registered
		Bit area RX/RX (in bits)	Input				
			EXW1-RDX*E4*	EXW1-RDY*E4*	EXW1-RDM*E3*		
1	15	64/64	3	3	-	6	
			-	-	3	3	
			2	2	1	5	
2	15	128/128	7	7	-	14	
			-	-	7	7	
			6	6	1	13	
3	15	384/384	23	23	-	15	
			-	-	23		
			22	22	1		
4	15	896/896	55	55	-	15	
			-	-	55		
			54	54	1		
5	31	384/384	23	23	-	31	
			-	-	23	23	
			22	22	1	31	
6	31	896/896	55	55	-		31
			-	-	55		
			54	54	1		
7	63	896/896	55	55	-	63	
			-	-	55	55	
			54	54	1	63	
8	127	896/896	55	55	-	110	
			-	-	55	55	
			54	54	1	109	

- Example of the number of other wireless remotes that can be registered

Example 1: For operation mode 4, EXA1-40-SA-ML remote, up to 3 units

(896 maximum occupied points of input RX - 16 points of management area) / 288 occupied points of remote's module input = 3 units

(896 maximum occupied points of output RY - 16 points of management area) / 144 occupied points of remote's module output = 6 units

Example 2: For operation mode 8, EXW1-RLAPA8C remote, wireless protocol V.2.0, up to 3 units

(896 maximum occupied points of input RX - 16 points of management area) / 272 occupied points of remote's module input = 3 units

(896 maximum occupied points of output RY - 16 points of management area) / 272 occupied points of remote's module output = 3 units

Specifications

Dimensions

○EXW1-BMJA*

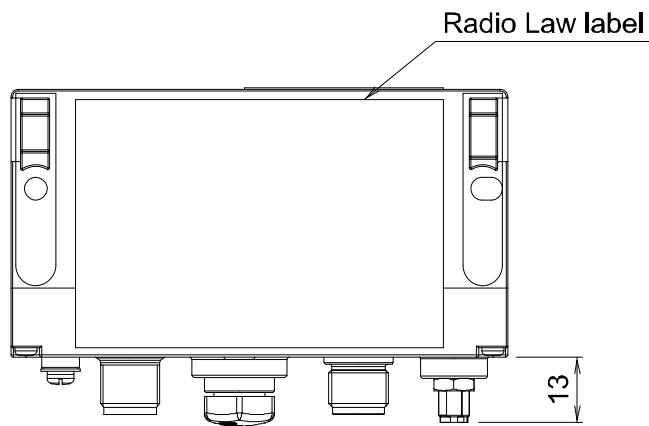
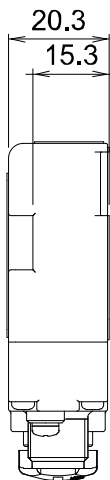
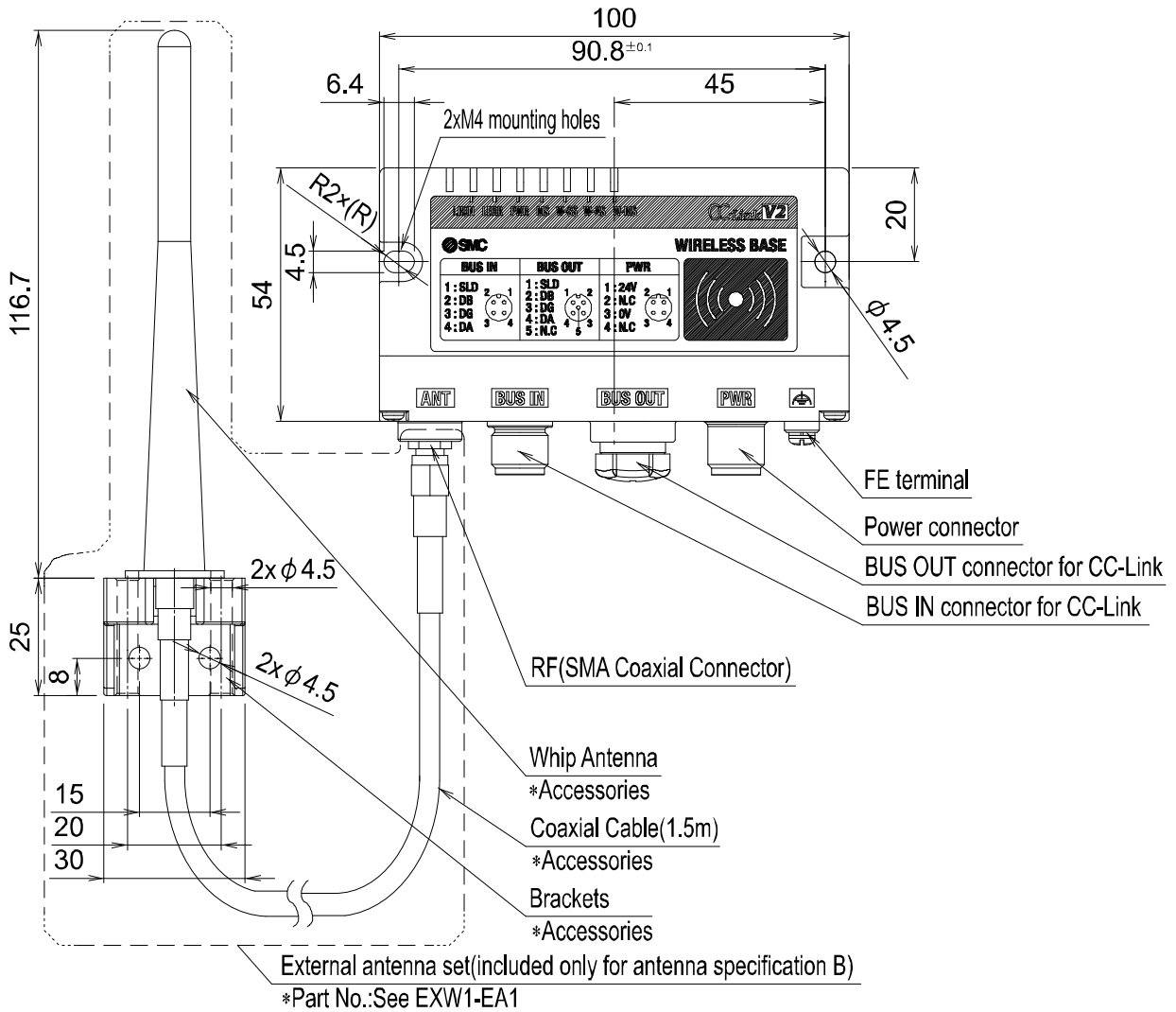

oEXW1-RD*

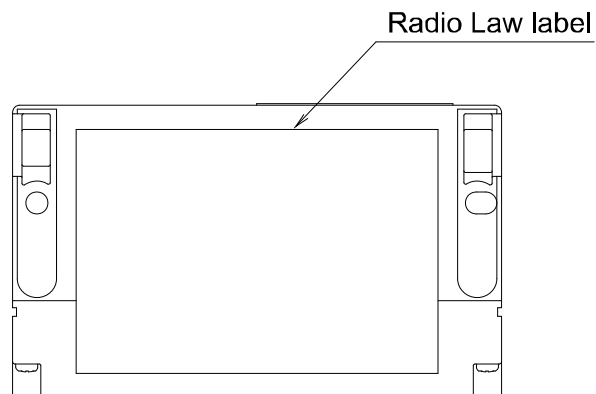
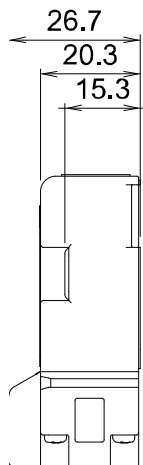
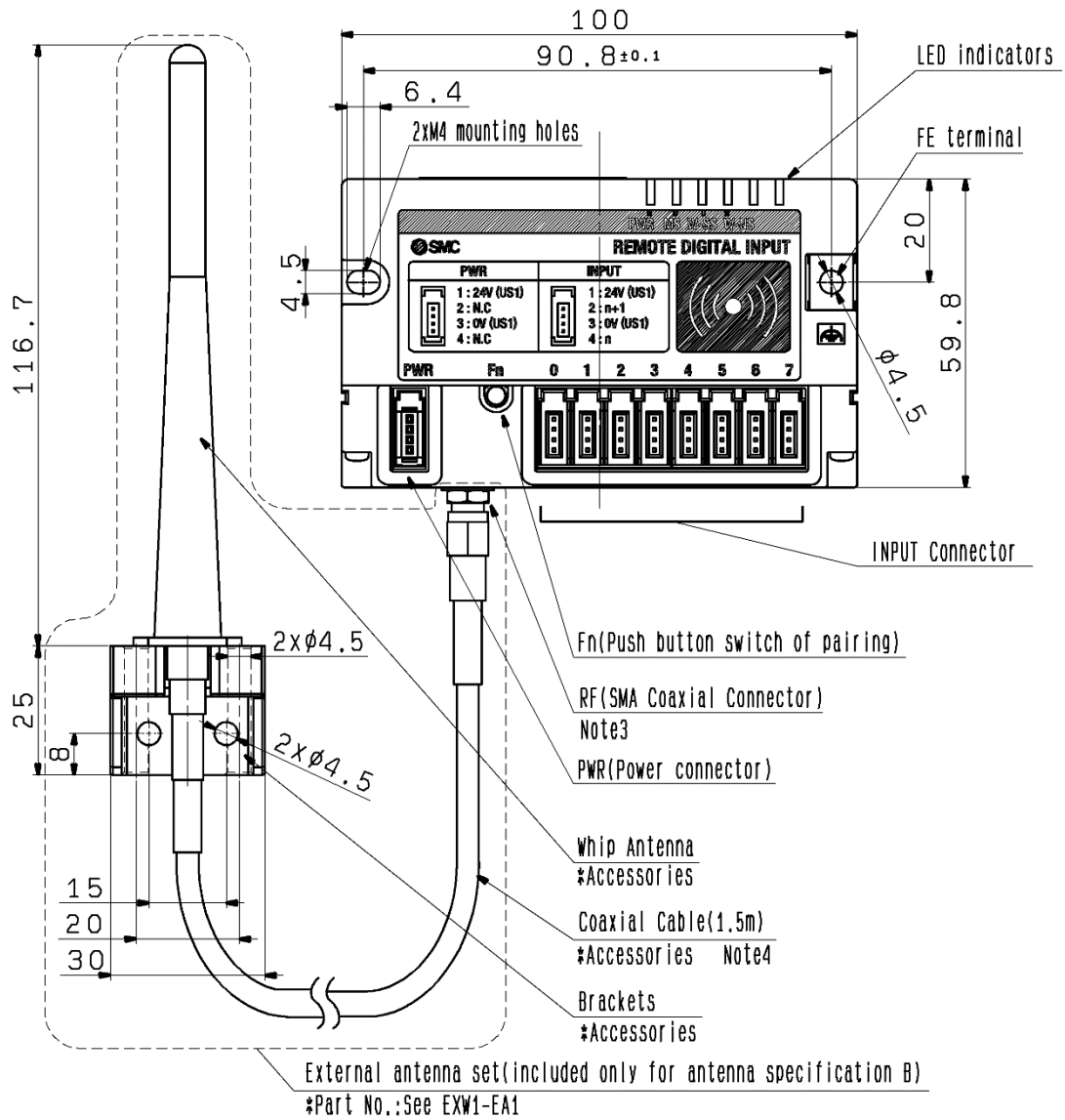

Specifications Table

○EXW1-BMJA*

CC-Link communication specifications

Item	Specification
Protocol	CC-Link (Ver.1.10, Ver.2.00)
Station type	Remote device
Device type	Wireless equipment (code 0x4B)
Station number	1-64 stations
Communication speed	156 / 625 kbps, 2.5 / 5 / 10 Mbps
Setting file	CSP+ file *1
Communication method	Broadcast polling
Occupied area (Inputs/ outputs)	Max (896 / 896) *2
Maximum number of occupied stations	4
Supported functions	Cyclic transmission Extended cyclic transmission (only when Ver.2.00 is specified) Longer cable between stations

*1: The setting file can be downloaded from the SMC Web site

*2: Varies depending on the operation mode setting

Electrical specifications

Item	Specification
US1 (for control) power supply voltage range	24 VDC+/-10 %
Current consumption	100 mA or less

General specifications

Item	Specification
Enclosure	IP67
Ambient operating temperature	-10 to +50°C
Ambient storage temperature	-20 to +60°C
Ambient humidity	35 to 85% RH (no condensation)
Withstand voltage	500 VAC 1.0 min. External terminals (including the FE terminal) and enclosure screws
Insulation resistance	10 MΩ or more 500 VDC External terminals (including the FE terminal) and enclosure screws
Vibration resistance	EN61131-2 compliant 5 ≤ f < 8.4 Hz 3.5 mm 8.4 ≤ f < 150 Hz 9.8 m/s ²
Impact resistance	EN61131-2 compliant, 147 m/s ² , 11 ms
Mounting	Through hole for M4 screw (2 pcs.)
Standards	CE/UKCA marked
Weight	150 g (body), 100 g (external antenna set)

Wireless communication specifications

Item	Specification
Protocol	SMC original protocol (SMC encryption)
Radio wave type (spread)	Frequency Hopping Spread Spectrum (FHSS)
Frequency band	2.4 GHz (2403~2481 MHz)
Frequency channel select function (F.C.S.)	Supported *1
Frequency channel	Max. 79 ch (Bandwidth: 1.0 MHz)
Communication speed	1 Mbps / 250 kbps *2
Communication distance	Up to 100 m line of sight (depending on the environment)
Radio Law certificate	Refer to the official SMC website for the latest information as to which countries the product is certified.

*1: The number of selectable frequency channels varies depending on the product number.

*2: Select a protocol before performing pairing (V.2.0: 1 Mbps, V.1.0: 250 kbps). Different communication speeds are mutually incompatible.

○EXW1-RDX*

The wireless communication specifications are the same as EXW1-BMJA*.

General specifications

Item	Specification
Enclosure	IP20
Ambient operating temperature	-10 to +50°C
Ambient storage temperature	-20 to +60°C
Ambient humidity	35 to 85% RH (no condensation)
Withstand voltage	500 VAC 1.0 min. External terminals (including the FE terminal) and enclosure screws
Insulation resistance	10 MΩ or more 500 VDC External terminals (including the FE terminal) and enclosure screws
Vibration resistance	EN61131-2 compliant 5 ≤ f < 8.4 Hz 3.5 mm 8.4 ≤ f < 150 Hz 9.8 m/s ²
Impact resistance	EN61131-2 compliant, 147 m/s ² , 11 ms
Mounting	Through hole for M4 screw (2 pcs.)
Standards	CE/UKCA marked
Weight	130 g (body), 100 g (external antenna set)

Electrical specifications

Item	EXW1-RDXPE4**	EXW1-RDXNE4**	
US1 (for control / input) power voltage drop	24 VDC +/-10%		
Current consumption	100 mA or less		
Input specification	Number of points	16 points (2 points / connector)	
	Output type	PNP	NPN
	Connector type	e-CON (4 pins)	
	Max. supply current for sensor	0.3 A / connector, 2 A/unit	
	ON current	Typ 0.5 mA	
	OFF current	2 mA or less	
	ON voltage	11 V or more	
	OFF voltage	5 V or less	
	Short circuit protection function	Available	

○EXW1-RDY*

The wireless communication specifications are the same as EXW1-BMJA*.

General specifications

Item	Specification
Enclosure	IP20
Ambient operating temperature	-10 to +50°C
Ambient storage temperature	-20 to +60°C
Ambient humidity	35 to 85% RH (no condensation)
Withstand voltage	500 VAC 1.0 min. External terminals (including the FE terminal) and enclosure screws
Insulation resistance	10 MΩ or more 500 VDC External terminals (including the FE terminal) and enclosure screws
Vibration resistance	EN61131-2 compliant 5 ≤ f < 8.4 Hz 3.5 mm 8.4 ≤ f < 150 Hz 9.8 m/s ²
Impact resistance	EN61131-2 compliant, 147 m/s ² , 11 ms
Mounting	Through hole for M4 screw (2 pcs.)
Standards	CE/UKCA marked
Weight	130 g (body), 100 g (external antenna set)

Electrical specifications

Item	EXW1-RDYPE4**	EXW1-RDYNE4**
US1 (for control / input) power voltage drop	24 VDC +/-10%	
US2 (for output) power voltage	24 VDC +/-10%	
Current consumption (US1)	100 mA or less	
Output specifications	Number of points	16 points (2 points / connector)
	Output type	PNP NPN
	Connector type	e-CON (4 pins)
	Maximum load current	0.3 A / point, 2 A / unit
	Short circuit protection function	Available

○EXW1-RDM*

The wireless communication specifications are the same as EXW1-BMJA*.

General specifications

Item	Specification
Enclosure	IP20
Ambient operating temperature	-10 to +50°C
Ambient storage temperature	-20 to +60°C
Ambient humidity	35 to 85% RH (no condensation)
Withstand voltage	500 VAC 1.0 min. External terminals (including the FE terminal) and enclosure screws
Insulation resistance	10 MΩ or more 500 VDC External terminals (including the FE terminal) and enclosure screws
Vibration resistance	EN61131-2 compliant 5 ≤ f < 8.4 Hz 3.5 mm 8.4 ≤ f < 150 Hz 9.8 m/s ²
Impact resistance	EN61131-2 compliant, 147 m/s ² , 11 ms
Mounting	Through hole for M4 screw (2 pcs.)
Standards	CE/UKCA marked
Weight	130 g (body), 100 g (external antenna set)

Electrical specifications

Item		EXW1-RDMP*	EXW1-RDMN*
US1 (for control / input) power voltage drop		24 VDC +/-10%	
US2 (for output) power voltage)		24 VDC +/-10%	
Current consumption (US1)		100 mA or less	
Input specifications	Number of points	8 points (2 points/connector)	
	Output type	PNP	NPN
	Connector type	e-CON (4 pins)	
	Max. supply current for sensor	0.3 A / connector, 1 A / unit	
	ON current	Typ 0.5 mA	
	OFF current	2 mA or less	
	ON voltage	11 V or more	
	OFF current	5 V or less	
Short circuit protection function		Available	
Output specifications	Number of points	8 points (2 points / connector)	
	Output type	PNP	NPN
	Connector type	e-CON (4 pins)	
	Maximum load current	0.3 A / point, 2 A / unit	
	Short circuit protection function	Available	

Accessories

Accessory List

For the selection of accessories, refer to the catalog.

(1) Assembly type connectors

- PCA-1557617 CC-Link communication, Plug
- PCA-1557620 CC-Link communication, Socket

(2) Power supply cables

- PCA-1564927 Cable with M12 connector, B code, Socket, Straight 2 m, SPEEDCON compatible
- PCA-1564930 Cable with M12 connector, B code, Socket, Straight 6 m, SPEEDCON compatible
- PCA-1564943 Cable with M12 connector, B code, Socket, Right angle 2 m, SPEEDCON compatible
- PCA-1564969 Cable with M12 connector, B code, Socket, Right angle 6 m, SPEEDCON compatible

(3) CC-Link communication cables

- PCA-1567720 Cable with M12 connector, A code, Socket, Straight 5 m, SPEEDCON compatible
- PCA-1567717 Cable with M12 connector, A code, Plug, Straight 5 m, SPEEDCON compatible
- EX9-AC005MJ-SSPS Connectors at both ends, A code, Socket/Plug, Straight 0.5 m, SPEEDCON compatible
- EX9-AC010MJ-SSPS Connectors at both ends, A code, Socket/Plug, Straight 1 m, SPEEDCON compatible
- EX9-AC020MJ-SSPS Connectors at both ends, A code, Socket/Plug, Straight 2 m, SPEEDCON compatible
- EX9-AC030MJ-SSPS Connectors at both ends, A code, Socket/Plug, Straight 3 m, SPEEDCON compatible
- EX9-AC050MJ-SSPS Connectors at both ends, A code, Socket/Plug, Straight 5 m, SPEEDCON compatible
- EX9-AC100MJ-SSPS Connectors at both ends, A code, Socket/Plug, Straight 10 m, SPEEDCON compatible
- EX9-AC005MJ-SAPA Connectors at both ends, A code, Socket/Plug, Right angle 0.5 m, SPEEDCON compatible
- EX9-AC010MJ-SAPA Connectors at both ends, A code, Socket/Plug, Right angle 1 m, SPEEDCON compatible
- EX9-AC020MJ-SAPA Connectors at both ends, A code, Socket/Plug, Right angle 2 m, SPEEDCON compatible
- EX9-AC030MJ-SAPA Connectors at both ends, A code, Socket/Plug, Right angle 3 m, SPEEDCON compatible
- EX9-AC050MJ-SAPA Connectors at both ends, A code, Socket/Plug, Right angle 5 m, SPEEDCON compatible
- EX9-AC100MJ-SAPA Connectors at both ends, A code, Socket/Plug, Right angle 10 m, SPEEDCON compatible

(4)e-CON

ZS-28-□

e-CON connector Part No.	AWG No.	Conductor cross sectional area (mm SQ)	Wire O.D. (mm)	Color of cover
ZS-28-C-1	24~26	0.14~0.2	ø1.0~ø1.2	Yellow
ZS-28-C-2			ø1.2~ø1.6	Orange
ZS-28-C-3	22~20	0.3~0.5	ø1.0~ø1.2	Green
ZS-28-C-4			ø1.2~ø1.6	Blue
ZS-28-C-5	-	0.1~0.5	ø1.6~ø2.0	Grey
ZS-28-CA-1			ø0.6~ø0.9	Orange
ZS-28-CA-2			ø0.9~ø1.0	Red
ZS-28-CA-3			ø1.0~ø1.15	Yellow
ZS-28-CA-4			ø1.15~ø1.35	Blue
ZS-28-CA-5			ø1.35~ø1.6	Green

(5) NFC reader/writer

EXW1-NT1

This set includes an NFC reader/writer and a USB extension cable (2.95 m).

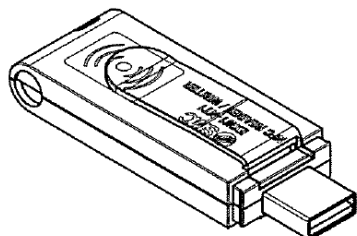

(6) External antenna set

EXW1-EA1

This set includes a whip antenna, a coaxial cable (1.5 m), a bracket and two screws (M2.6 x 8).

(7) NFC reader/writer holder

EXW1-AB1 (for EX600-W)

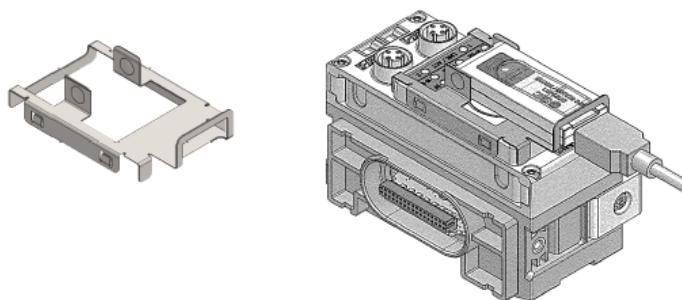

EXW1-AB2 (for EXW1)

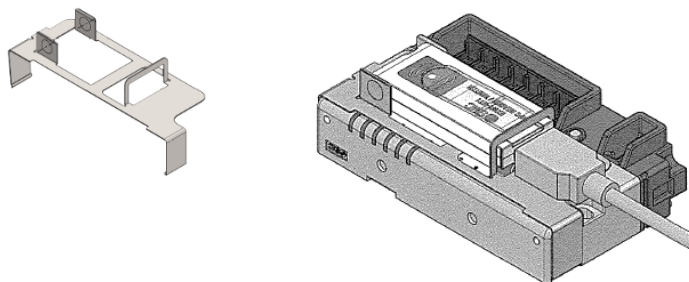

Revision history

A: Modified errors in text. [March 2022]
B: Contents are added [May 2022]
C: Contents are added [February 2023]
D: Content changes [May 2024]
E: Content changes [June 2024]
F: Content changes [December 2024]

SMC Corporation

Tel: + 81 3 5207 8249 Fax: +81 3 5298 5362

URL <https://www.smcworld.com>

Note: Specifications are subject to change without prior notice and any obligation on the part of the manufacturer.

The descriptions of products shown in this document may be used by the other companies as their trademarks.

© SMC Corporation All Rights Reserved

