



Operation Manual

PRODUCT NAME

Compact Wireless Base

MODEL / Series / Product Number

EXW1-BECAC

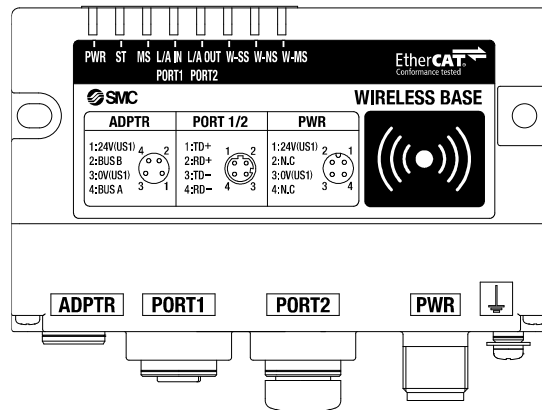

SMC Corporation

Table of Contents

Safety Instructions	2
Limited warranty and Disclaimer/Compliance Requirements	3
Precautions regarding the Radio Law	6
EXW1-RD*	6
EXW1-A11*	7
Precautions for Handling	9
Important Instructions concerning the Wireless System	11
SMC Wireless System	12
Features and Summary	12
System Configuration	13
System compatibility	14
How to Order	19
Summary of Product parts	20
EXW1-BECAC	20
EXW1-A11 *	24
EXW1-RD*	25
Setting and Adjustment	31
Flow chart for operating the wireless system	31
I/O Configurator (NFC version)	32
Preparation	33
Installation of the software	33
Download the I/O Configurator (NFC version)	34
Start the I/O Configurator (NFC version)	35
Screen Layouts of the I/O Configurator (NFC Version)	36
Before starting the software	38
Monitoring and setting up	41
Setting/Adjustment of the Wireless Unit	42
Parameter settings of a Remote (optional)	42
Remote setting	42
Parameter settings of the Base	44
System setting	44
Remote registration	47
Frequency channel select function (F.C.S.)	48
Event	50
Wireless	52
Pairing and Unpairing Procedures	54
Pairing Procedure	54
Unpairing Procedure	63
Mounting and Installation of Units	65
EXW1-BECAC, EXW1-RD*	65
Troubleshooting	72
Technical Information	85
I/O Map	85
I/O Mapping	87
Diagnostics Mapping	88
I/O mapping order of Base/Remote	89
Diagnostics map details	91
ESI file	99
CoE Object	101
Specifications	117
Dimensions	117
Specifications Table	120
Accessories	125



Safety Instructions

These safety instructions are intended to prevent hazardous situations and/or equipment damage. These instructions indicate the level of potential hazard with the labels of “**Caution,**” “**Warning**” or “**Danger.**” They are all important notes for safety and must be followed in addition to International Standards (ISO/IEC)^{*)}, and other safety regulations.

*1) ISO 4414: Pneumatic fluid power - General rules and safety requirements for systems and their components
ISO 4413: Hydraulic fluid power - General rules and safety requirements for systems and their components
IEC 60204-1: Safety of machinery - Electrical equipment of machines - Part 1: General requirements
ISO 10218-1: Robots and robotic devices - Safety requirements for industrial robots - Part 1: Robots
etc.



Danger

Danger indicates a hazard with a high level of risk which, if not avoided, will result in death or serious injury.



Warning

Warning indicates a hazard with a medium level of risk which, if not avoided, could result in death or serious injury.



Caution

Caution indicates a hazard with a low level of risk which, if not avoided, could result in minor or moderate injury.



Warning

1. The compatibility of the product is the responsibility of the person who designs the equipment or decides its specifications.

Since the product specified here is used under various operating conditions, its compatibility with specific equipment must be decided by the person who designs the equipment or decides its specifications based on necessary analysis and test results. The expected performance and safety assurance of the equipment will be the responsibility of the person who has determined its compatibility with the product. This person should also continuously review all specifications of the product referring to its latest catalog information, with a view to giving due consideration to any possibility of equipment failure when configuring the equipment.

2. Only personnel with appropriate training should operate machinery and equipment.

The product specified here may become unsafe if handled incorrectly. The assembly, operation and maintenance of machines or equipment including our products must be performed by an operator who is appropriately trained and experienced.

3. Do not service or attempt to remove product and machinery/equipment until safety is confirmed.

1. The inspection and maintenance of machinery/equipment should only be performed after measures to prevent falling or runaway of the driven objects have been confirmed.

2. When the product is to be removed, confirm that the safety measures as mentioned above are implemented and the power from any appropriate source is cut, and read and understand the specific product precautions of all relevant products carefully.

3. Before machinery/equipment is restarted, take measures to prevent unexpected operation and malfunction.

4. Our products cannot be used beyond their specifications. Our products are not developed, designed, and manufactured to be used under the following conditions or environments. Use under such conditions or environments is not covered.

1. Conditions and environments outside of the given specifications, or use outdoors or in a place exposed to direct sunlight.

2. Use for nuclear power, railways, aviation, space equipment, ships, vehicles, military application, equipment affecting human life, body, and property, fuel equipment, entertainment equipment, emergency shut-off circuits, press clutches, brake circuits, safety equipment, etc., and use for applications that do not conform to standard specifications such as catalogs and operation manuals.

3. Use for interlock circuits, except for use with double interlock such as installing a mechanical protection function in case of failure. Please periodically inspect the product to confirm that the product is operating properly.



Safety Instructions

Caution

We develop, design, and manufacture our products to be used for automatic control equipment, and provide them for peaceful use in manufacturing business.

Use in non-manufacturing business is not covered.

Products we manufacture and sell cannot be used for the purpose of transactions or certification specified in the Measurement Act.

The new Measurement Act prohibits use of any unit other than SI units in Japan.

Limited warranty and Disclaimer/Compliance Requirements

The product used is subject to the following “Limited warranty and Disclaimer” and “Compliance Requirements”.

Read and accept them before using the product.

Limited warranty and Disclaimer

1. The warranty period of the product is 1 year in service or 1.5 years after the product is delivered, whichever is first.*2)

Also, the product may have specified durability, running distance or replacement parts. Please consult your nearest sales branch.

2. For any failure or damage reported within the warranty period which is clearly our responsibility, a replacement product or necessary parts will be provided.

This limited warranty applies only to our product independently, and not to any other damage incurred due to the failure of the product.

3. Prior to using SMC products, please read and understand the warranty terms and disclaimers noted in the specified catalog for the particular products.

***2) Vacuum pads are excluded from this 1 year warranty.**

A vacuum pad is a consumable part, so it is warranted for a year after it is delivered.

Also, even within the warranty period, the wear of a product due to the use of the vacuum pad or failure due to the deterioration of rubber material are not covered by the limited warranty

Compliance Requirements

1. The use of SMC products with production equipment for the manufacture of weapons of mass destruction (WMD) or any other weapon is strictly prohibited.

2. The exports of SMC products or technology from one country to another are governed by the relevant security laws and regulations of the countries involved in the transaction. Prior to the shipment of a SMC product to another country, assure that all local rules governing that export are known and followed.

Caution

SMC products are not intended for use as instruments for legal metrology.

Products that SMC manufactures or sells are not measurement instruments that are qualified by pattern approval tests relating to the measurement laws of each country.

Therefore, SMC products cannot be used for business or certification ordained by the measurement laws of each country.

Operator

- ◆ This operation manual is intended for those who have knowledge of machinery using pneumatic equipment, and have sufficient knowledge of assembly, operation and maintenance of such equipment. Only those persons are allowed to perform assembly, operation and maintenance.
- ◆ Read and understand this operation manual carefully before assembling, operating or providing maintenance to the product.

■ Safety Instructions

Warning

- Do not disassemble, modify (including changing the printed circuit board) or repair.
An injury or failure can result.
- Do not operate or set with wet hands.
This may lead to an electric shock.
- Do not operate the product outside of the specifications.
Do not use for flammable or harmful fluids.
Fire, malfunction, or damage to the product can result.
Verify the specifications before use.
- Do not operate in an atmosphere containing flammable or explosive gases.
Fire or an explosion can result.
This product is not designed to be explosion proof.
- If using the product in an interlocking circuit:
 - Provide a double interlocking system, for example a mechanical system.
 - Check the product regularly for proper operation.Otherwise malfunction can result, causing an accident.
- The following instructions must be followed during maintenance:
 - Turn off the power supply.
 - Stop the air supply, exhaust the residual pressure and verify that the air is released before performing maintenance.Otherwise an injury can result.

Caution

- When handling the unit or assembling/replacing units:
 - Do not touch the sharp metal parts of the connector or plug for connecting units.
 - Take care not to hit your hand when disassembling the unit.
The connecting portions of the unit are firmly joined with seals.
 - When joining units, take care not to get fingers caught between units.
An injury can result.

- After maintenance is complete, perform appropriate functional inspections.
Stop operation if the equipment does not function properly.
Safety cannot be assured in the case of unexpected malfunction.

- Provide grounding to assure noise resistance of the Fieldbus system.
Individual grounding should be provided close to the product with a short cable.

Precautions regarding the Radio Law

EXW1-RD*

This equipment has been tested and found to comply with the limits for a Class B digital device, pursuant to part 15 of the FCC Rules. These limits are designed to provide reasonable protection against harmful interference in a residential installation. This equipment generates, uses and can radiate radio frequency energy and, if not installed and used in accordance with the instructions, may cause harmful interference to radio communications. However, there is no guarantee that interference will not occur in a particular installation. If this equipment does cause harmful interference to radio or television reception, which can be determined by turning the equipment off and on, the user is encouraged to try to correct the interference by one or more of the following measures:

- Reorient or relocate the receiving antenna.
- Increase the separation between the equipment and receiver.
- Connect the equipment into an outlet on a circuit different from that to which the receiver is connected.
- Consult the dealer or an experienced radio/TV technician for help.

Caution

Any changes or modifications not expressly approved by the grantee of this device could void the user's authority to operate the equipment.

This device complies with part 15 of the FCC Rules. Operation is subject to the following two conditions:

- (1) this device may not cause harmful interference, and
- (2) this device must accept any interference received, including interference that may cause undesired operation.

This device complies with Industry Canada's licence-exempt RSSs. Operation is subject to the following two conditions:

- (1) This device may not cause interference; and
- (2) This device must accept any interference, including interference that may cause undesired operation of the device.

Le présent appareil est conforme aux CNR d'Industrie Canada applicables aux appareils radio exempts de licence.

L'exploitation est autorisée aux deux conditions suivantes:

- (1) l'appareil ne doit pas produire de brouillage, et
- (2) l'utilisateur de l'appareil doit accepter tout brouillage radioélectrique subi, même si le brouillage est susceptible d'en compromettre le fonctionnement.

Caution

When operating this device, follow the safety requirements for radio frequency exposure established by the Federal Communications Commission (FCC) and Innovation, Science and Economic Development Canada, and keep the human body (excluding fingers, hands, wrists, ankles, and feet) at least 20 cm away from the device.

When installing this device, place it 20 cm away from the end user.

Este equipamento não tem direito à proteção contra interferência prejudicial e não pode causar interferência em sistemas devidamente autorizados. Para maiores informações, consulte o site da ANATEL – www.anatel.gov.br

ANATEL : 06513-22-14800

Made in Japan

Incorpora produto homologado pela Anatel sob número 06513-22-14800

เครื่องโทรคมนาคมและอุปกรณ์นี้มีความสอดคล้องตามมาตรฐานหรือข้อกำหนดทางเทคนิคของ กสทช.

(This telecommunication equipment conforms to the technical standards or requirements of NBTC.)

La operación de este equipo está sujeta a las siguientes dos condiciones: (1) es posible que este equipo o dispositivo no cause interferencia perjudicial y (2) este equipo o dispositivo debe aceptar cualquier interferencia, incluyendo la que pueda causar su operación no deseada.

 **Caution****Notice:**

Changes or modifications not expressly approved by the manufacturer could void the user's authority to operate the equipment.

NOTE:

This equipment has been tested and found to comply with the limits for a Class B digital device, pursuant to part 15 of the FCC rules.

These limits are designed to provide reasonable protection against harmful interference in a residential installation. This equipment generates, uses and can radiate radio frequency energy and, if not installed and used in accordance with the instructions, may cause harmful interference to radio communications.

However, there is no guarantee that interference will not occur in a particular installation.

If this equipment does cause harmful interference to radio or television reception, which can be determined by turning the equipment off and on, the user is encouraged to try to correct the interference by one or more of the following measures:

1. Reorient or relocate the receiving antenna.
2. Increase the separation between the equipment and receiver.
3. Connect the equipment into an outlet on a circuit different from that to which the receiver is connected.
4. Consult the dealer or an experienced radio/TV technician for help.

This equipment has been tested and found to comply with Part 15 of the FCC Rules. Operation is subject to the following two conditions:

- (1) This device may not cause harmful interference
- (2) This device must accept any interference received, including interference that may cause undesired operation.

This device complies with part 15 of the FCC Rules. Operation is subject to the following two conditions:

- (1) this device may not cause harmful interference, and
- (2) this device must accept any interference received, including interference that may cause undesired operation.

This device is authorized under Title 47 CFR 15.519 (the FCC Rules and Regulations).

The operation of this device is subject to the following restriction:

The changes or substitutions of the antennas which are furnished with the device is prohibited.

FCC ID : 2AJE7SMC-WEX08

This device complies with Industry Canada license-exempt RSS standard(s). Operation is subject to the following two conditions: (1) this device may not cause interference, and (2) this device must accept any interference, including interference that may cause undesired operation of the device.

Le présent appareil est conforme aux CNR d'Industrie Canada applicables aux appareils radio exempts de licence. L'exploitation est autorisée aux deux conditions suivantes : (1) l'appareil ne doit pas produire de brouillage, et (2) l'utilisateur de l'appareil doit accepter tout brouillage radioélectrique subi, même si le brouillage est susceptible d'en compromettre le fonctionnement.

Caution

This device and its antenna(s) must not be co-located or operation in conjunction with any other antenna or transmitter. Changes or modifications not expressly approved by the party responsible for compliance could void the user's authority to operate the equipment.

"Operation is subject to the following two conditions: (1) this device may not cause interference, and (2) this device must accept any interference, including interference that may cause undesired operation of the device."

Le présent appareil est conforme aux CNR d'Industrie Canada applicables aux appareils radio exempts de licence. L'exploitation est autorisée aux deux conditions suivantes : (1) l'appareil ne doit pas produire de brouillage, et (2) l'utilisateur de l'appareil doit accepter tout brouillage radioélectrique subi, même si le brouillage est susceptible d'en compromettre le fonctionnement.

"This Class B digital apparatus complies with Canadian ICES-003."

Cet appareil numérique de la classe B est conforme à la norme NMB-003 du Canada.

"This device and its antenna(s) must not be co-located or operating in conjunction with any other antenna or transmitter."

Cet appareil et son antenne (s) ne doit pas être co-localisés ou fonctionnant en conjonction avec une autre antenne ou transmetteur.

"This equipment should be installed and operated with a minimum distance of 20cm between the radiator and your body"

Cet équipement doit être installé et utilisé à une distance minimale de 20cm entre le radiateur et votre corps.

NCC 警語

取得審驗證明之低功率射頻器材，非經核准，公司、商號或使用者均不得擅自變更頻率、加大功率或變更原設計之特性及功能。低功率射頻器材之使用不得影響飛航安全及干擾合法通信；經發現有干擾現象時，應立即停用，並改善至無干擾時方得繼續使用。前述合法通信，指依電信管理法規定作業之無線電通信。低功率射頻器材須忍受合法通信或工業、科學及醫療用電波輻射性電機設備之干擾。

"Este equipamento não tem direito à proteção contra interferência prejudicial e não pode causar interferência em sistemas devidamente autorizados"

"Para maiores informações, consulte o site da ANATEL – www.anatel.gov.br"

La operación de este equipo está sujeta a las siguientes dos condiciones: (1) es posible que este equipo o dispositivo no cause interferencia perjudicial y (2) este equipo o dispositivo debe aceptar cualquier interferencia, incluyendo la que pueda causar su operación no deseada.

Precautions for Handling

○ Follow the instructions given below for selecting and handling.

- The instructions on design and selection

- * Product specifications

- Use within the specified voltage.

- Otherwise, failure or malfunction can result.

- The power is supplied from the circuit reinforced or double-insulated from MAINS.

- The direct current power supply used should be UL approved as follows.

- UL1310 Class 2 power supply unit or UL61010-1 LIM (Limited Energy Circuit).

- All external circuits should also be connected to a circuit that is reinforced or double-insulated from the MAINS and free from risk of electric shock and fire hazard.

- Reserve a space for maintenance.

- Design the system to allow the required space for maintenance.

- Do not remove the label.

- This can lead to incorrect maintenance, or misreading of the operation manual, which can cause damage or malfunction to the product.

- It may also result in nonconformity to safety standards.

- Beware of inrush current when the power supply is turned on.

- An initial charge current may activate the over current protection function depending on the connected load, resulting in the unit malfunctioning.

- For UL/cUL certification, install in a distribution box or other container. (EXW1-A1*).

- Product Handling

- * Mounting

- Do not drop, hit or apply excessive shock to the product.

- Otherwise damage to the internal parts can result, causing malfunction.

- Tighten to the specified tightening torque.

- If the tightening torque is exceeded, the mounting screws can be broken.

- If the screws are tightened to a different torque, IP67 will not be achieved.

- Never mount the product in a location that will be used as a foothold.

- The product may be damaged if excessive force is applied by stepping or climbing onto it.

- * Wiring (Including connecting/disconnecting of the connectors)

- Avoid bending or stretching the cables repeatedly, or placing a heavy load or apply force to the product.

- Applying repeated bending and tensile stress to the cable may cause broken wires.

- Wire correctly.

- Incorrect wiring may cause malfunction of or damage to the wireless system.

- Do not perform wiring while the power is on.

- Otherwise the wireless system may be damaged or malfunction.

- Do not route wires and cables together with power or high voltage cables.

- The product can malfunction due to interference of noise and surge voltage from power and high voltage cables close to the signal line.

- Route the wires of the wireless system separately from power or high voltage cables.

- Confirm correct insulation of wiring.

- Poor insulation (interference with other circuits, poor insulation between terminals, etc.) can apply excessive voltage or current to the wireless system causing damage to it.

- When a wireless system is installed in machinery/equipment, provide adequate protection against noise by using noise filters, etc.

- Noise in signal lines may cause malfunction.

*Operating environment

- Select the correct type of enclosure according to the operating environment.
 - IP67 protection class is achieved when the following conditions are met.
 - (1) The units are connected correctly using power supply cables and communication cables with M12 (or M8) connectors.
 - (2) Suitable mounting of each unit and manifold valve.
 - (3) Be sure to fit a water resistant cap on any unused connectors.
 - If using in an environment that is exposed to water splashes, please take protective measures, such as using a cover.
 - Do not use in an atmosphere having water, water steam, or where there is direct contact with any of these. These may cause failure or malfunction.
- Do not use the product in a place where the product could be splashed by oil or chemicals.
 - Operating in environments with coolants, cleaning solvents, various oils or chemicals may cause adverse effects (failure, malfunction) to the unit even in a short period of time.
- Do not use the product in an environment where corrosive gases or fluids can be splashed.
 - Otherwise damage to the unit can result, causing malfunction.
- Do not use in an area where surges are generated.
 - If there is equipment generating large surge near the unit (magnetic type lifter, high frequency inductive furnace, welding machine, motor, etc.), this can cause deterioration of the internal circuitry element of the unit or result in damage. Take measures against the surge sources, and prevent the lines from coming into close contact.
- When a surge-generating load such as a relay, valve, or lamp is directly driven, use the product with built in surge protection.
 - Direct drive of a load generating surge voltage can damage the unit.
- The product is CE marked, but is not immune to lightning strikes. Take measures against lightning strikes in the system.
- Prevent foreign matter such as dust or wire debris from entering inside the product.
 - Otherwise it can cause damage or malfunction.
- Mount the product in a place that is not exposed to vibration or impact.
 - Otherwise it can cause damage or malfunction.
- Do not use the product in an environment that is exposed to temperature cycles.
 - Heat cycles other than ordinary changes in temperature can adversely affect the inside of the product.
- Do not expose the product to direct sunlight.
 - If using in a location directly exposed to sunlight, shade the product from the sunlight.
 - Otherwise it can cause damage or malfunction.
- Keep within the specified ambient temperature range.
 - Otherwise malfunction can result.

- Do not operate close to a heat source, or in a location exposed to radiant heat.
 - Otherwise malfunction can result.

*Adjustment and Operation

- Perform settings suitable for the operating conditions.
 - Incorrect setting can cause operation failure.
 - (Refer to "Setting and Adjustment".)
- Please refer to the PLC manufacturer's manual, etc. for details of PLC-side programming and addresses.

For the PLC protocol and programming, refer to the relevant manufacturer's documentation.

*Maintenance

- Turn off the power supply, stop the supplied air, exhaust the residual pressure and verify the release of air, before performing maintenance.

Otherwise safety is not assured due to an unexpected malfunction or incorrect operation.

- Perform regular maintenance and inspections.

There is a risk of unexpected operation due to malfunction of the equipment.

- After maintenance is complete, perform appropriate functional inspections.

Stop operation if the equipment does not function correctly.

Otherwise safety cannot be assured due to an unexpected malfunction or incorrect operation.

- Do not use solvents such as benzene, thinner, etc. to clean each unit.

These can damage the surface of the body and erase the markings on the product.

Use a soft cloth to remove stains.

For heavy stains, use a damp cloth that has been soaked with diluted neutral detergent and fully squeezed, then wipe up the stains again with a dry cloth.

Important Instructions concerning the Wireless System

● Connect the wireless adaptor to this product.

- The wireless adaptor (EXW1-A11*) and the wireless remote (EXW1-RD*) are certified as wireless equipment in accordance with the Radio Act and the certification of construction type has been obtained. Customers do not need to apply for a license to use this equipment.

Be sure to comply with the following precautions.

- Do not disassemble or modify the product. Disassembly and modification are prohibited by law.

- Attach and use the supplied antenna set (EXW1-EA1) as an external antenna of the wireless remote (EXW1-RD*).

The law forbids the use of antennas and coaxial cables that are not sold by SMC.

- This product is compliant with the Radio Act in Japan, European countries and the US. For the latest information, refer to the catalog on the website below.

URL <https://www.smcworld.com>

- This product communicates using radio waves, and the communication may be temporarily interrupted due to the ambient environments and operating methods. SMC will not be responsible for any secondary failure which may cause an accident or cause damage to other devices or equipment.
- When several units are installed close to each other, slight interference may occur due to the characteristics of the wireless product.
- Radio waves emitted by this product may adversely affect implantable medical devices such as implantable cardiac pacemakers and brillators.
For precautions regarding the use of equipment or devices that may adversely affect performance, refer to the catalog or instruction manuals for the equipment or devices, or contact the manufacturers directly.
- The communication performance is affected by the ambient environment, so please perform communication testing before use.

SMC Wireless System

Features and Summary

SMC Wireless Products, EX600-W and EXW1 series products, are modular devices consisting of a gateway (hereafter referred to as a Base) and wireless devices (hereafter referred to as Remotes). The Base has the function to communicate with an upper-level device (PLC) and paired Remotes. From the upper-level device point of view, the wireless network acts a single modular device through the Base.

From an upper-level (PLC) control component, a Base appears to be a single system including Remotes paired with it, and up to 11784 inputs (1473 byte) and 11784 outputs (1473 byte) can be handled per system.

Bases and Remotes are designed to be identifiable by registering their uniquely assigned PIDs (Product IDs) with each other and operate therefore function without conflicts even when several Bases and Remotes operate in the same area.

The packet of the wireless transmit and receive data is encrypted. It is therefore difficult to manipulate the data.

The SMC wireless system has the following features.

- Quick start-up takes 0.25 sec. (minimum) to connect to the system when the Remote is powered. *1
- Parameter setting by Near Field Communication (NFC) using a PC (no HW setting).
- The maximum number of inputs/outputs of the system is 11784 /11784 *2, 3
- Up to 127 Remotes can be registered per Base*4

*1: The Base is in start-up mode, and will change depending on the Remote power-on timing and external influences.

*2: The maximum number of inputs/outputs is 896/896. If there are more than 896 inputs or outputs, they are not recognized.
There might be communication delay depending on the communication load status.

*3: Total number of Remote inputs/output registered in the Base.

*4: The maximum number of units that can be connected is 127. If 127 units is exceeded, the unit I/O will not be recognized.
There might be communication delay depending on the communication load status.

System Configuration

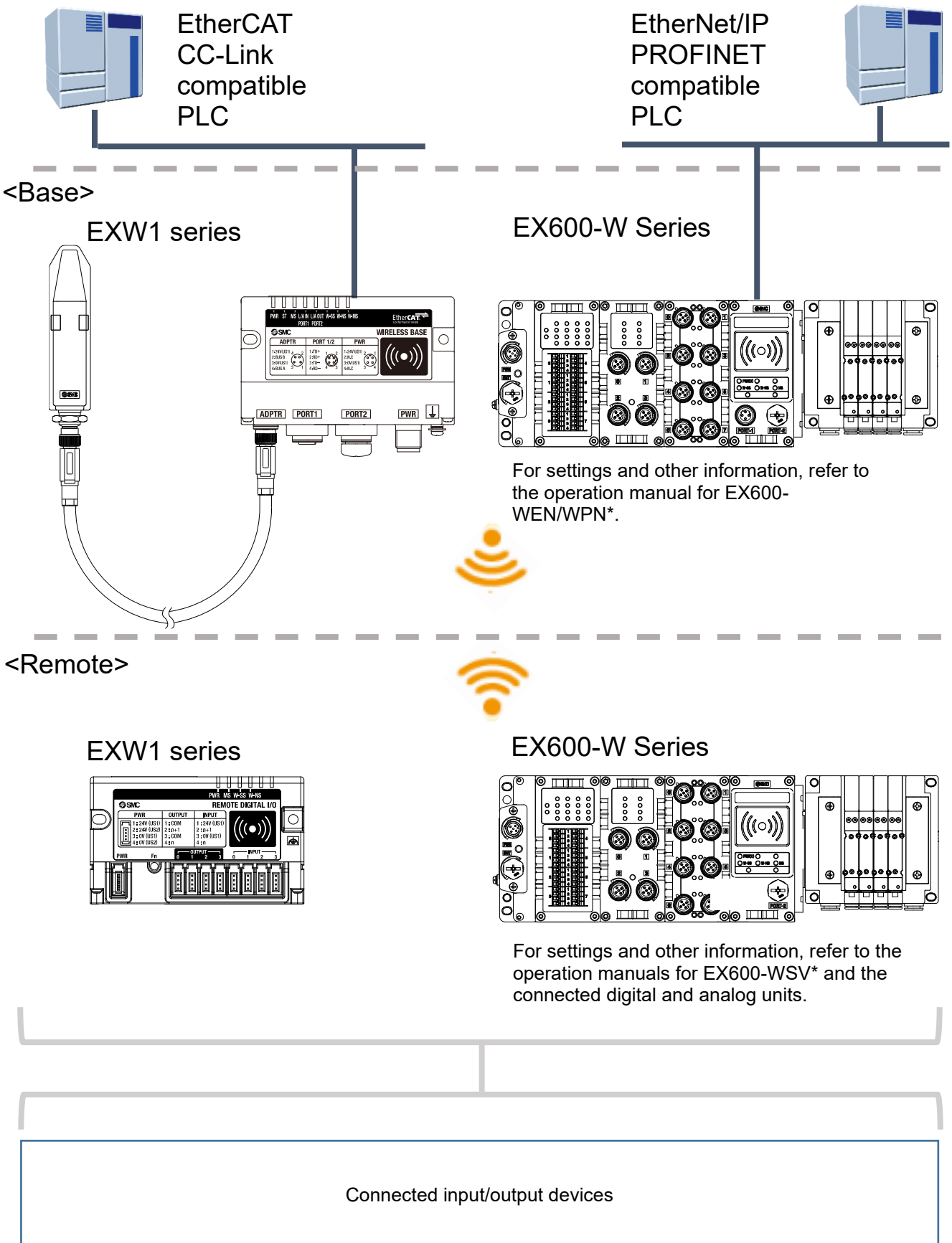

For settings and other information, refer to the operation manual for EX600-WEN/WPN*.

For settings and other information, refer to the operation manuals for EX600-WSV* and the connected digital and analog units.

System compatibility

Mixed use with EX600-W Series

Although it is possible to use with EX600-W series, the operating conditions must comply with the specifications of the existing wireless system. Note that the following functions may be restricted:

- Communication distance
The maximum communication distance will vary depending upon the system configuration. Please see the details in the table on the next page.
- Protocol
This refers to the wireless communication version. For more details, check the system settings of the Base.
- Frequency channel select function (F.C.S.)
The frequency channel to use can be selected using this function.
 - * The number of selectable frequency channels varies depending on the country of use.
 - For more details, check the product number.

Number of selectable frequency channels	Applicable country
Min. 5 channels, Max. 79 channels	Certified countries except for the U.S., Canada, South Korea, Brazil, Taiwan, Argentina, and Mexico.
Min. 15 channels, Max. 79 channels	Certified countries including the U.S., Canada, South Korea, Brazil, Taiwan, Argentina, and Mexico.

* If no channel is selected, communication is established on 79 channels by default.

* For the latest information, refer to the catalog on the website below.

URL <https://www.smcworld.com>

The figure below shows an example where only the frequency channels that do not clash with two wireless LAN channels are used for wireless communication.

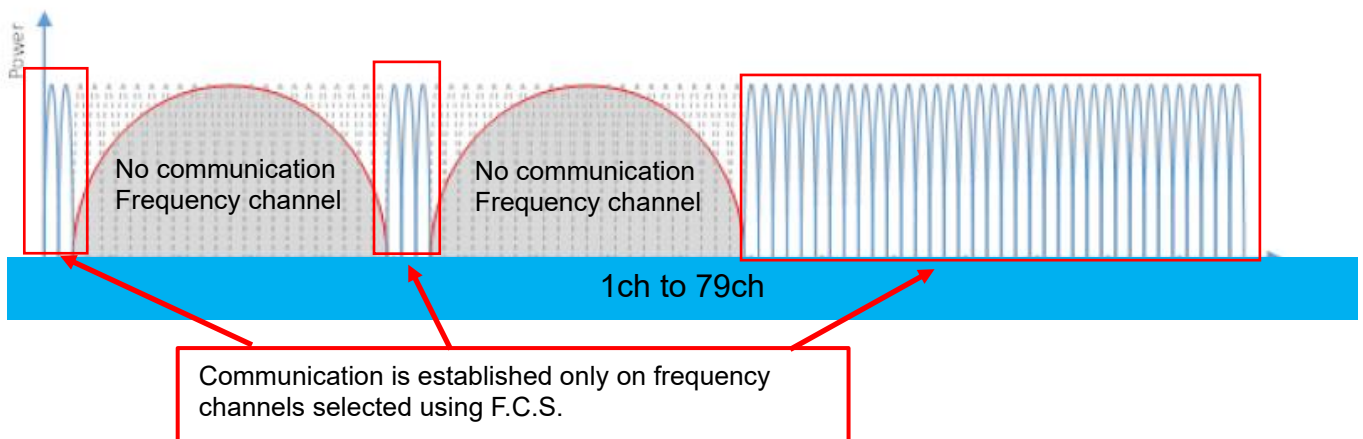

- WEB function (supported only by EX600-WEN/WPN)
Various product settings and communication statuses can be checked by accessing EX600-WEN/WPN from a PC.

Refer to the system configuration example below.

System configuration example			Applicable function				
No.	Wireless Base	Wireless Remote	Communication distance	Protocol	Frequency channel select function (F.C.S.)	Parameter (CoE bject)	WEB function
1	EXW1	EXW1	Up to 100 m	V.1.0/ V.2.0*1	Available*2	Available*2	-
2	EXW1	EXW1+EX600	*3	V.1.0	NA	NA	-
3	EXW1	EX600	Up to 10 m	V.1.0	NA	NA	-
4	EX600	EXW1	Up to 10 m	V.1.0	NA	NA	Available*4
5	EX600	EXW1+EX600	Up to 10 m	V.1.0	NA	NA	Available*4
6*5	EX600	EX600	Up to 10 m	V.1.0	NA	NA	Available

*1: For more details, check the system settings of the Base.

*2: Only available in Protocol V.2.0.

*3: Up to 100 m between an EXW1 series Base and Remote, and up to 10 m between an EXW1 series Base and an EX600-W series Remote.

4: The settings and monitor function are restricted when communication is established between EX600-WEN/WPN and EXW1-R.

*5: This configuration consists solely of EX600-W series units; refer to the operation manual for the product in use.

- System configuration example 1
Wireless Base : EXW1-BECAC
Wireless Remote : EXW1 series

<Wireless Base>

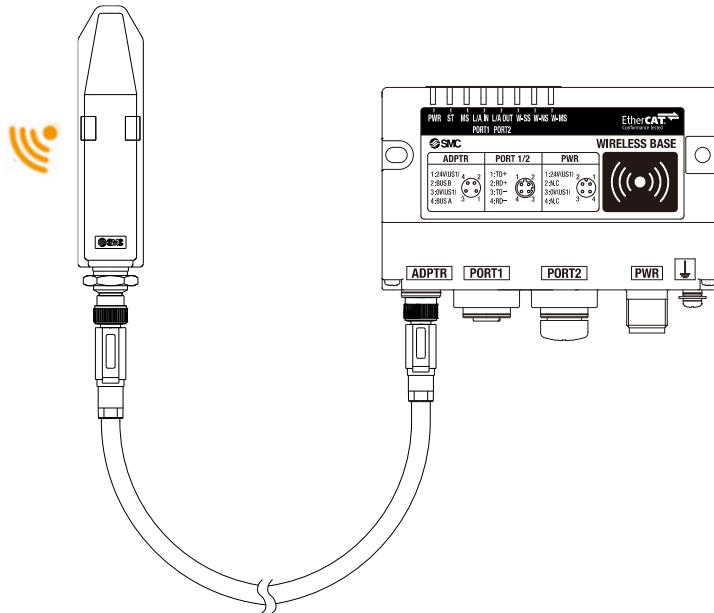

<Wireless Remote>



○ System configuration 2

Wireless Base : EXW1-BECAC

Wireless Remote : EXW1 series, EX600-W series

<Wireless Base>

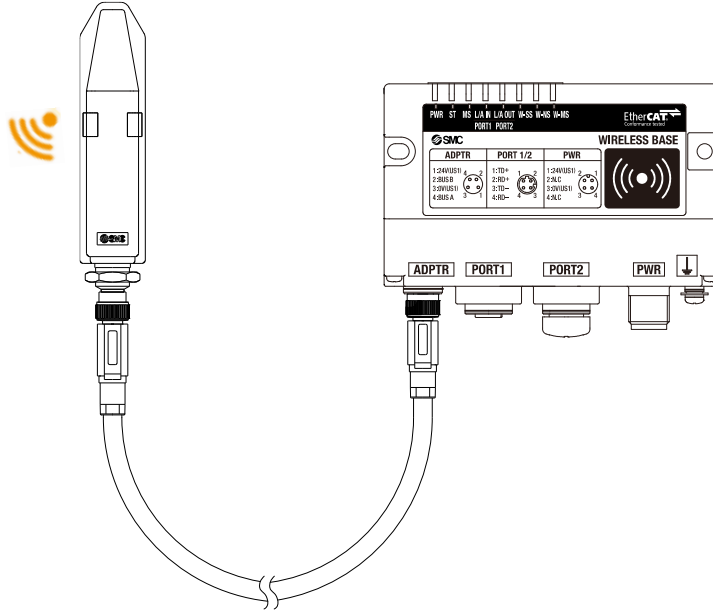

<Wireless Remote>

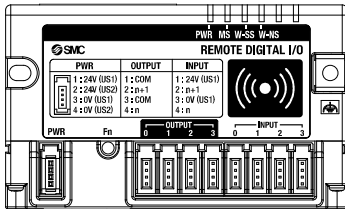

EXW1 series

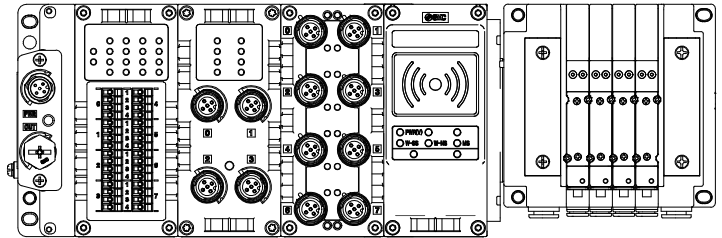

EX600-W Series

○ System configuration 3

Wireless Base: EXW1-BECAC

Wireless Remote: EX600-W

<Wireless Base>

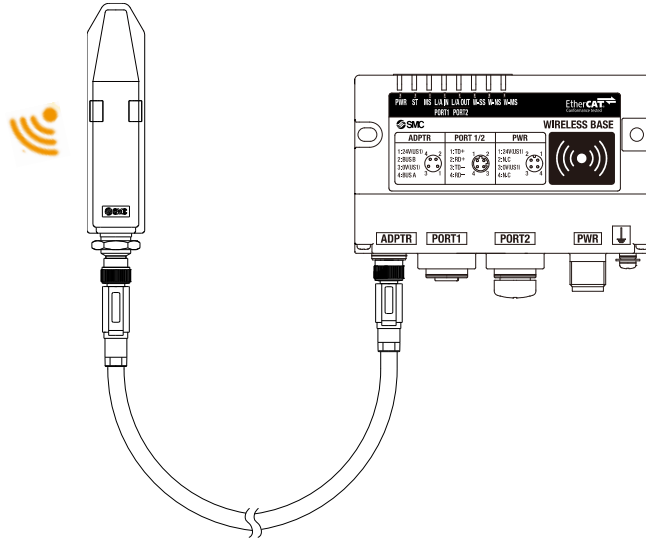

<Wireless Remote>

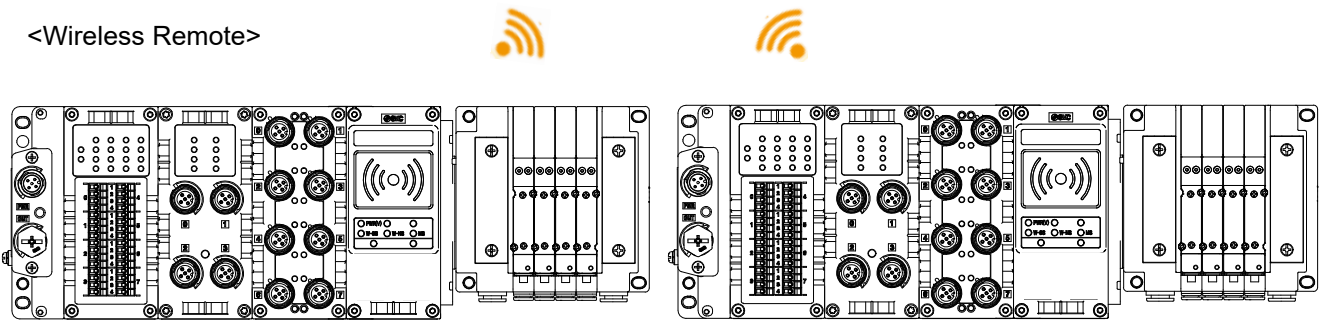

EX600-W Series

○ System configuration 4

Wireless Base: EX600-W series

Wireless Remote: EXW1 series

<Wireless Base>

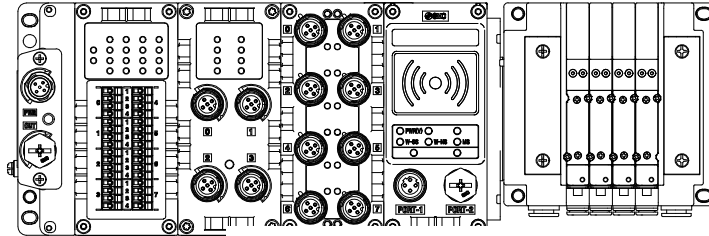

EX600-W Series



<Wireless Remote>

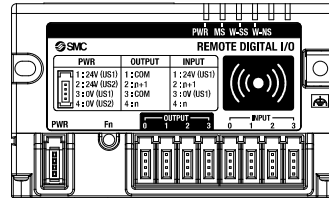
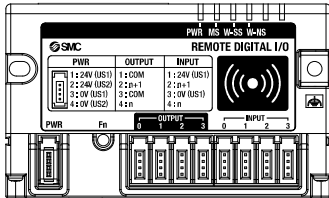

○ System configuration 5

Wireless Base: EX600-W series

Wireless Remote: EXW1 series, EX600-W series

<Wireless Base>

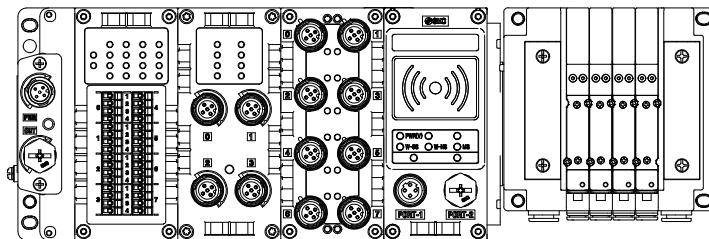

EX600-W Series



<Wireless Remote>

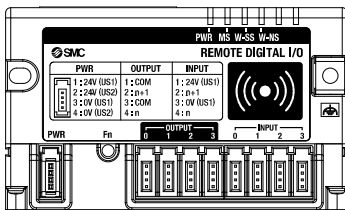

EXW1 series

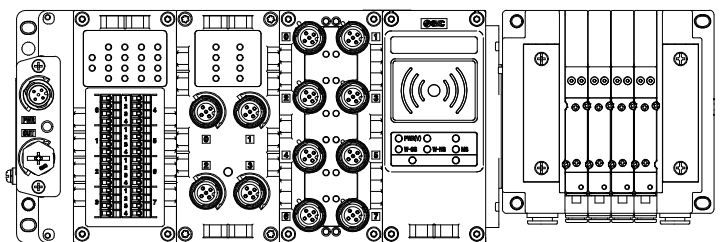

EX600-W Series

o System configuration 6

- Wireless Base: EX600-W series
- Wireless Remote: EX600-W series

For system configurations of EX600-W series, refer to the operation manual for the product in use.

How to Order

The product system, model names and part numbering system of SMC wireless systems are as follows.

<Compact wireless Base>

This product line-up consists of one model, namely EXW1-BECAC.

<Wireless Adaptor>

This product line-up consists of two models, namely EXW1-A11E and EXW1-A11N.

<Compact wireless Remotes>

This product line-up consists of 16 models, namely EXW1-RDXNE4AE, EXW1-RDXNE4AN, EXW1-RDXNE4BE, EXW1-RDXNE4BN, EXW1-RDYNE4AE, EXW1-RDYNE4AN, EXW1-RDYNE4BE, EXW1-RDYNE4BN, EXW1-RDMPE3AE, EXW1-RDMPE3AN, EXW1-RDMPE3BE, EXW1-RDMPE3BN, EXW1-RDMNE3AE, EXW1-RDMNE3AN, EXW1-RDMNE3BE and EXW1-RDMNE3BN.

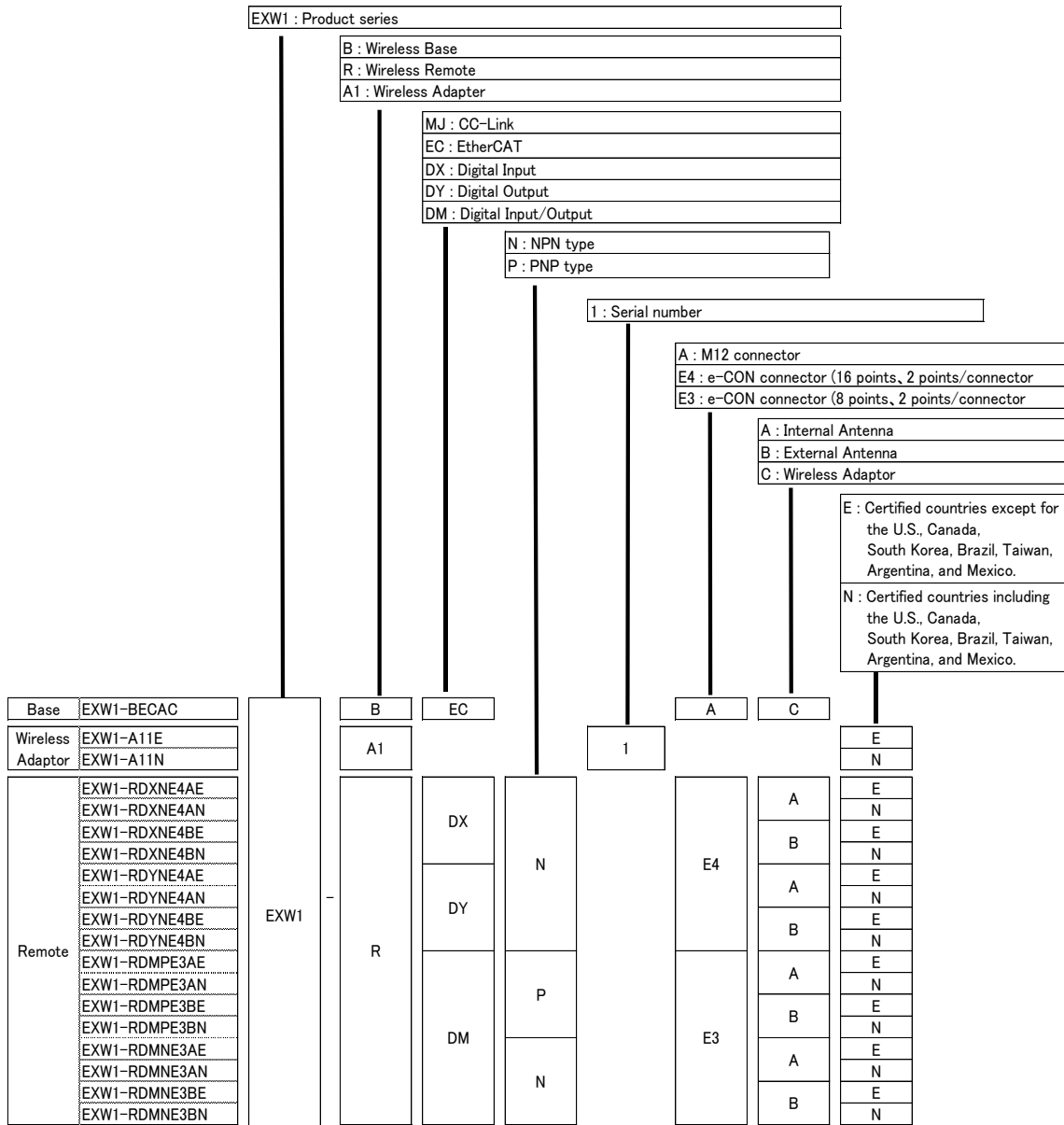

Summary of Product parts

EXW1-BECAC

Appearance

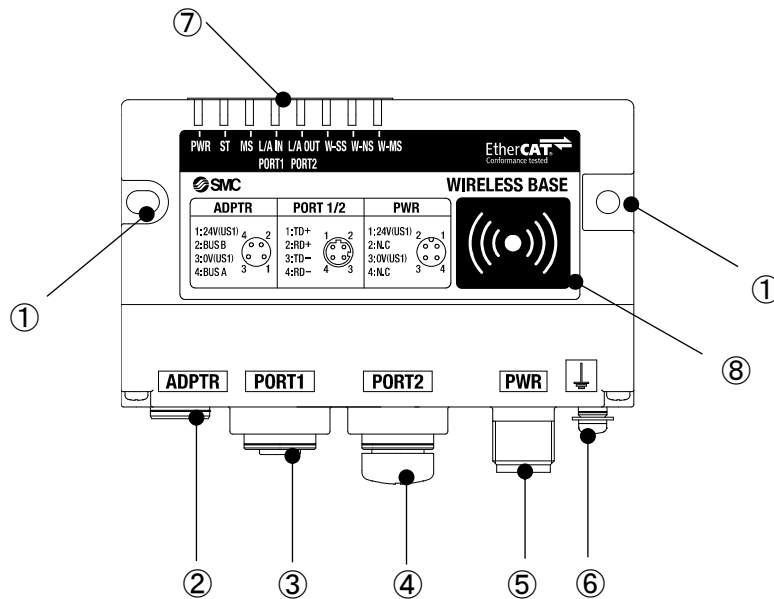

No.	Name	Application
1	Screw hole for mounting (2 x M4)	Mounting the compact wireless Base.
2	Connector for wireless adaptor (ADPTR)	Connect the cable for wireless adaptor.
3	Communication connector (PORT1)	Connection for the cable for fieldbus inputs.
4	Communication connector (PORT2)	Connection for the cable for fieldbus outputs.
5	Power supply connector	Supplies power to the compact wireless Base.
6	FE terminal	To be connected to Ground (for improved noise immunity).
7	LED	Indicates the status of the compact wireless Base or Remote.
8	NFC antenna approach area	This area is in close contact with the NFC reader / writer. "o" is the center of the NFC antenna.

* Grounding should be as close as possible to the product and the grounding wire should be as short as possible.

LED

The LED indicators at the top left corner of the compact wireless Base indicate the power supply, communication and diagnostic status.

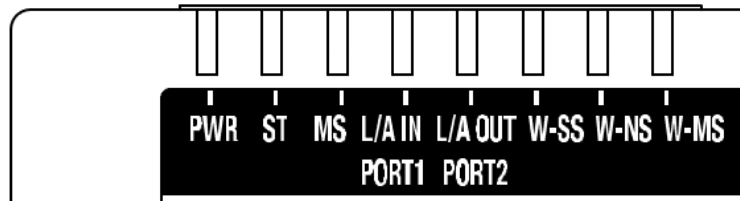

LED indicators of the compact wireless Base

LED name	Function	LED status		Description
		Colour of LED	ON/Flashing	
PWR	US1 (for control) power supply status indicator	Green	ON	The US1 (for control) power supply is ON
		-	OFF	The US1 (for control) power supply is OFF
ST	EtherCAT status indicator	Green	ON	EtherCAT communication OPERATIONAL state
		Green	Single flashing*	EtherCAT communication SAFE-OPERATIONAL state
		Green	Blinking*	EtherCAT communication PRE-OPERATIONAL state
		Green	Flickering*	EtherCAT communication BOOTSTRAP state
		Red	Single flashing*	Sync error. Communication data error
		Red	Double flashing*	Sync Manager watchdog timeout
		Red	Blinking*	Invalid configuration
		Red	ON	Unrecoverable error is detected.
		-	OFF	EtherCAT INIT state or The US1 (for control) power supply is OFF
MS	Base system status indicator	Green	ON	The compact wireless Base is operating normally
		Red	Flashing	Recoverable error is detected. (LED flashes when more than one diagnostic information item is detected.) •US1 (for control) power supply voltage level is abnormal •Number of system inputs/outputs setting error •Number of registered Remotes setting error •Wireless adaptor internal connection error •Abnormal number of registered Remotes
		Red	ON	Unrecoverable error is detected.
		-	OFF	The US1 (for control) power supply is OFF
L/A IN	Port1 communication status indicator	Green	ON	Link, No Activity
		Green	Flickering	Link, Activity
		-	OFF	No Link, No Activity
L/A OUT	Port2 communication status indicator	Green	ON	Link, No Activity
		Green	Flickering	Link, Activity
		-	OFF	No Link, No Activity
W-SS	Radio wave receiving intensity	Green	ON	The level of received radio wave power of all the connected Remotes is 3
		Green	Flashing (1 Hz)	The level of received radio wave power of some connected Remotes is 2
		Green	Flashing (2 Hz)	The level of received radio wave power of some connected Remotes is 1
		Red	Flashing	All the Remotes that support protocol V.1.0 are not connected
		Orange	Flashing	All the Remotes that support protocol V.2.0 are not connected
		-	OFF	Remote not registered

LED name	Function	LED status		Description
		Colour of LED	ON/Flashing	
W-NS	Wireless communication connection status indicator	Green	ON	All the Remote connections are normal
		Green	Flashing	Some Remotes are not connected
		Red	Flashing	No Remotes are connected
		Red	ON	No Remotes are connected (Unrecoverable error in wireless communication)
		Red Green	Alternate Flashing	Wireless communication connection is being configured (Pairing)
		Orange	ON	Force ON mode
		-	OFF	Remote not registered
W-MS	Remote system status indication	Green	ON	Wireless Remote is normal Protocol V.1.0 (Pairing)
		Orange	ON	Protocol V.2.0 (Pairing)
		Red	Flashing	Recoverable error is detected. (LED flashes when more than one diagnostic information item is detected.) <ul style="list-style-type: none"> •US1 (for control / input) power supply voltage level is abnormal •US2 (for output) power supply voltage level is abnormal •Excessive I/O setting inputs/outputs •Analog I/O upper setting limit exceeded •Analog input range upper and lower limits exceeded •Error in communication between units •EX600 I/O unit detects diagnostic information •Valve diagnostic information detected
		Red	ON	Unrecoverable error is detected.
		-	OFF	Remote not registered

*Refer to below for LED status.

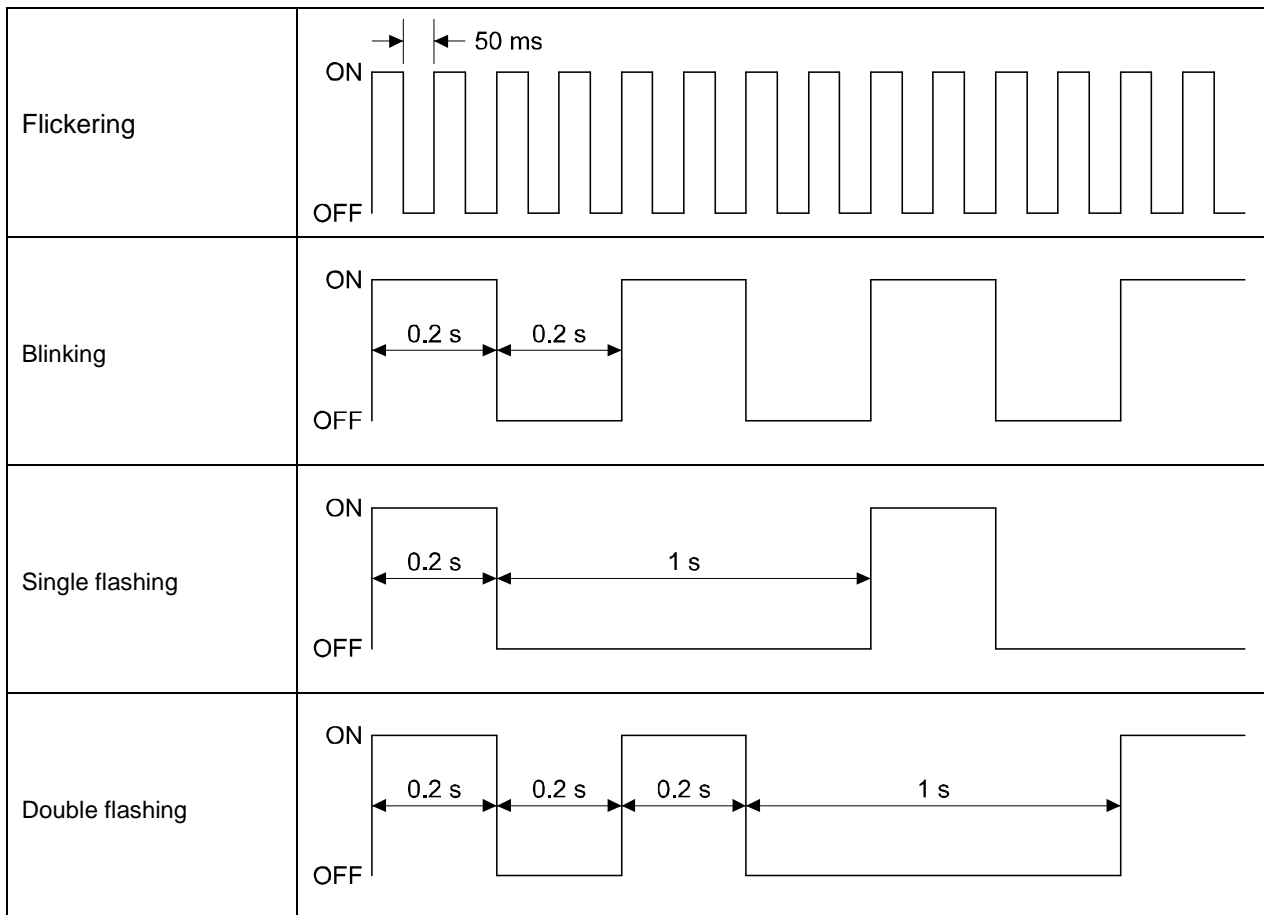

Connectors

•Power supply connector

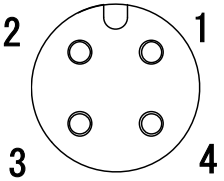
No.	Signal	M12, 4-pin, plug
		A code
1	24V (US1)	
2	N.C.	
3	0V (US1)	
4	N.C.	

•Communication connector For EtherCAT PORT1/PORT2

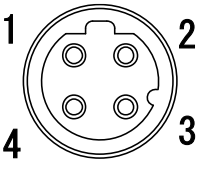
No.	Signal	M12, 4-pin, socket
		D code
1	TD+	
2	RD+	
3	TD-	
4	RD-	

•Connector for wireless adaptor

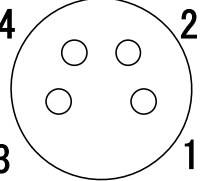
No.	Signal	M8, 4-pin, socket
1	24V (US1)	
2	Internal BUS B	
3	0V (US1)	
4	Internal BUS A	

*Use the wireless adaptor cable specified to connect to the wireless adaptor.

EXW1-A11 *

Appearance



No.	Name	Application
①	Connector	Connector for Wireless Adaptor cable.
②	Nut	For fixing to Air Management system.
③	LED display	Indicates the status of the adaptor.

LED

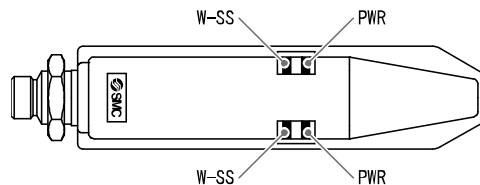

LED name	Function	LED status		Description
		Colour of LED	ON/Flashing	
PWR	Power supply and status indication	Green	ON	Power supply voltage is in ON state
		Orange	Flashing	An internal communication error is detected
		Red	ON	Unrecoverable error is detected
		-	OFF	Power supply voltage is in OFF state
W-SS	Received signal strength indicator	Green	ON	The level of received radio wave strength of all the connected Remotes is 3
		Green	Flashing (1 Hz)	The level of received radio wave strength of some connected Remotes is 2
		Green	Flashing (2 Hz)	The level of received radio wave strength of some connected Remotes is 1
		Red	Flashing	Protocol V.1.0 all remote is not established
		Orange	Flashing	Protocol V.2.0 all remote is not established
		-	OFF	Remote not registered

Connector

No.	Signal	M8, 4-pin, plug
1	24V (US1)	
2	Internal BUS B	
3	0V (US1)	
4	Internal BUS A	

*Use the wireless adaptor cable specified to connect to the wireless adaptor.

EXW1-RD*

Appearance

EXW1-RDX*B*

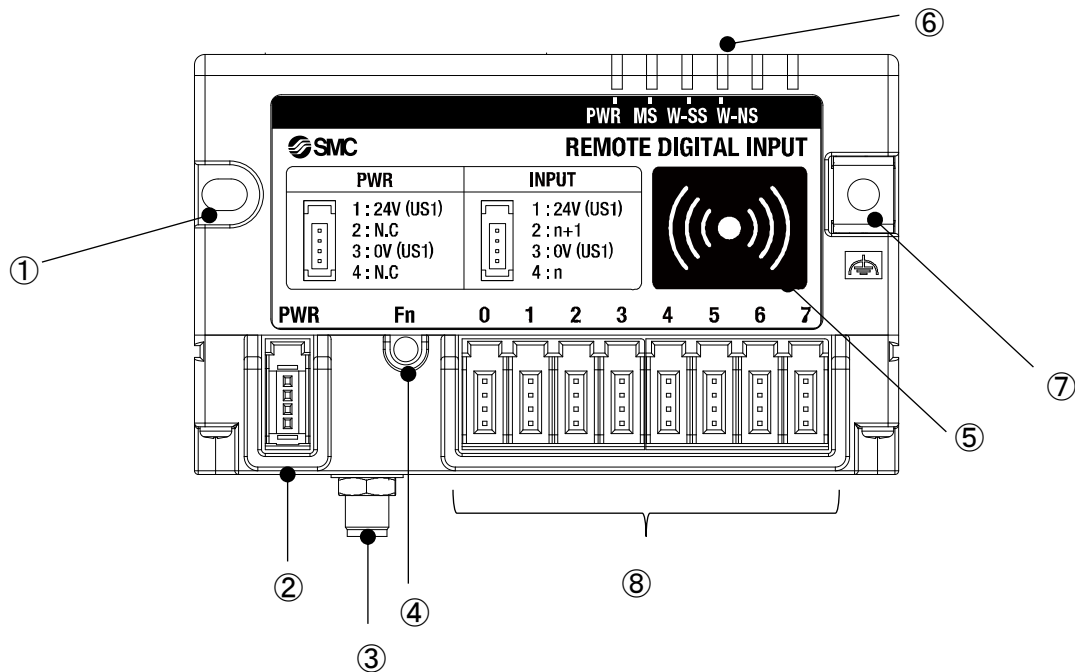

No.	Name	Application
1	Screw hole for mounting (M4)	Mounting the compact wireless Remote.
2	PWR (Power connector)	Supplies power to the compact wireless Remote.
3	RF (SMA coaxial connector) * Exclusive to external antenna versions	Connector for the coaxial cable of an external antenna.
4	Fn (Pairing button)	Press the button when switching to pairing mode.
5	NFC antenna approach area	This area is in close contact with the NFC reader / writer. "o" is the center of the NFC antenna.
6	LED	Indicates the status of the compact wireless Remote.
7	FE terminal, screw hole for mounting (M4)	To be connected to Ground (for improved noise immunity). This doubles as a screw hole for mounting.
8	Connector for an input device x 8	Connector for an input device. (PIN2, PIN4: input)

EXW1-RDY*B*

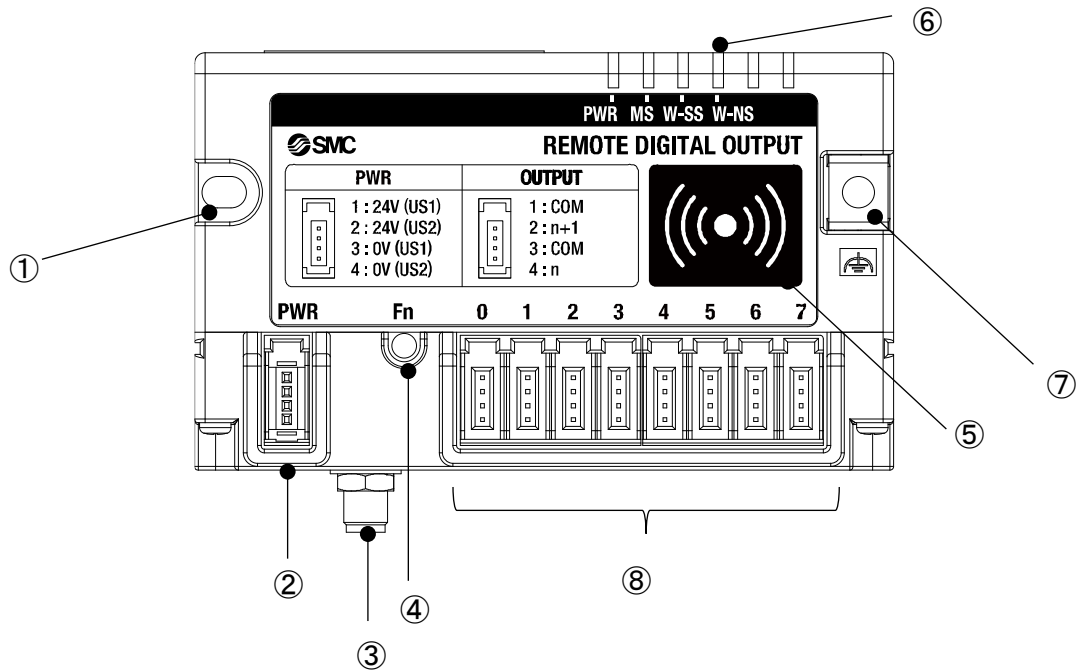

No.	Name	Application
1	Screw hole for mounting (M4)	Mounting the compact wireless Remote.
2	PWR (Power connector)	Supplies power to the compact wireless Remote.
3	RF (SMA coaxial connector) * Exclusive to external antenna versions	Connector for the coaxial cable of an external antenna.
4	Fn (Pairing button)	Press the button when switching to pairing mode.
5	NFC antenna approach area	This area is in close contact with the NFC reader / writer. "o" is the center of the NFC antenna.
6	LED	Indicates the status of the compact wireless Remote.
7	FE terminal, screw hole for mounting (M4)	To be connected to Ground (for improved noise immunity). This doubles as a screw hole for mounting
8	Connector for an output device x 8	Connector for an output device. (PIN2, PIN4: output)

EXW1-RDM*B*

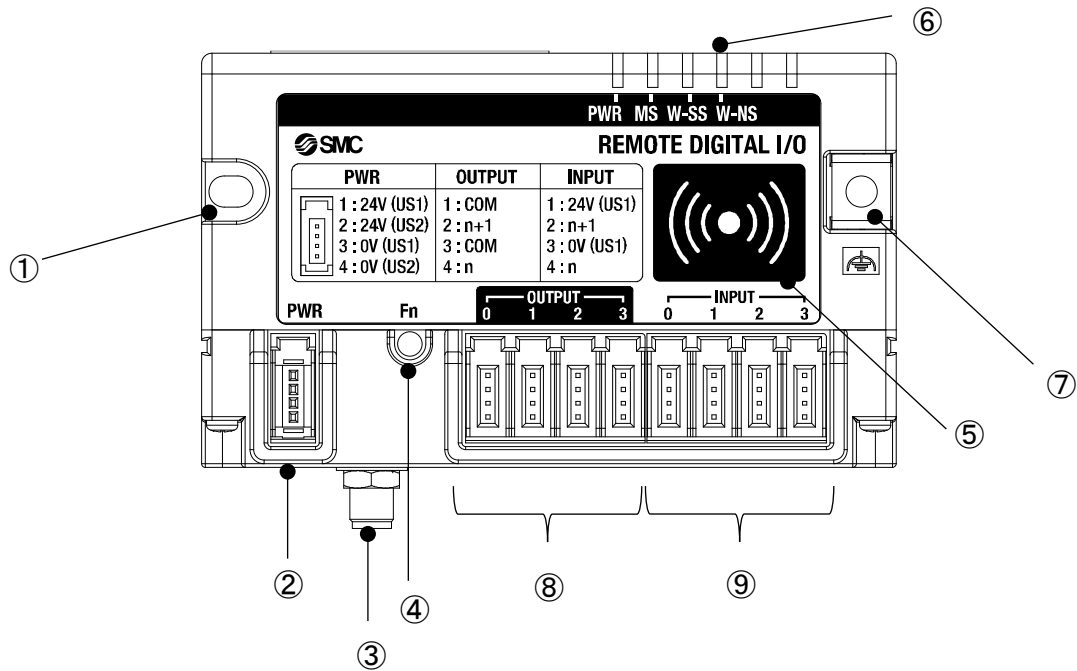

No.	Name	Application
1	Screw hole for mounting (M4)	Mounting the compact wireless Remote.
2	PWR (Power connector)	Supplies power to the compact wireless Remote.
3	RF (SMA coaxial connector) * Exclusive to external antenna versions	Connector for the coaxial cable of an external antenna.
4	Fn (Pairing button)	Pressed when switching to pairing mode.
5	NFC antenna approach area	This area is in close contact with the NFC reader / writer. "o" is the center of the NFC antenna.
6	LED	Indicates the status of the compact wireless Remote.
7	FE terminal, screw hole for mounting (M4)	To be connected to Ground (for improved noise immunity). This doubles as a screw hole for mounting.
8	Connector for an output device x 4	Connector for an output device. (PIN2, PIN4: output)
9	Connector for an input device x 4	Connector for an input device. (PIN2, PIN4: input)

LED

oEXW1-RD*

The LED indicators at the top right corner of the compact wireless Remote indicate the power supply, communication and diagnostic status.

The same LED indications are used for the EXW1-RD*.

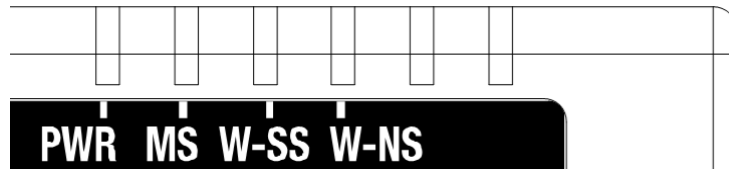

LED indicators of the compact wireless Remote

LED name	Function	LED status		Description
		Colour of LED	ON/Flashing	
PWR	Indicates the power supply voltage (US1/ US2) status	Green	ON	The US1 (for control / input) power supply is ON
		Red	Flashing	US2 (for output) power supply voltage level is abnormal (when the setting is enabled)
		-	OFF	The US1 (for control / input) power supply is OFF
MS	Status of Remote	Green	ON	Operating normally
		Red	Flashing	Recoverable error is detected. (LED flashes when more than one diagnostic information item is detected.) •US1 (for control and input) power supply voltage level is abnormal (when the setting is enabled) •Short-circuit detection of the US1 (for control / input) power supply •Short-circuit detection of the US2 (for output) power supply
		Red	ON	Unrecoverable error is detected.
		-	OFF	The US1 (for control / input) power supply is OFF
W-SS	Radio wave receiving intensity	Green	ON	Received radio wave intensity level 3
		Green	Flashing (1 Hz)	Received radio wave intensity level 2
		Green	Flashing (2 Hz)	Received radio wave intensity level 1
		Red	Flashing	Protocol V.1.0 wireless communication is not established
		Orange	Flashing	Protocol V.2.0 wireless communication is not established
		-	OFF	Base not registered
W-NS	Wireless communication connection status indication	Green	ON	Base connected correctly
		Red	Flashing	Base not connected
		Orange	Flashing	Pairing operation is in progress
		Orange	ON	Force ON mode
		Red	ON	Base not connected (Unrecoverable error in wireless communication)
		Red Green	Alternate Flashing	Wireless communication connection is being configured (pairing)
		-	OFF	Base not registered The US1 (for control / input) power supply is OFF

Connector (for e-CON)

○EXW1-RDX*

PWR (power connector)

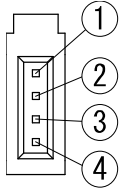

Pin number	Description
1	24V(US1)
2	N.C.
3	0V(US1)
4	N.C.

INPUT (connector for an input device)

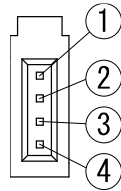

Pin number	Description
1	24V(US1)
2	n+1
3	0V(US1)
4	n

Circuit diagram

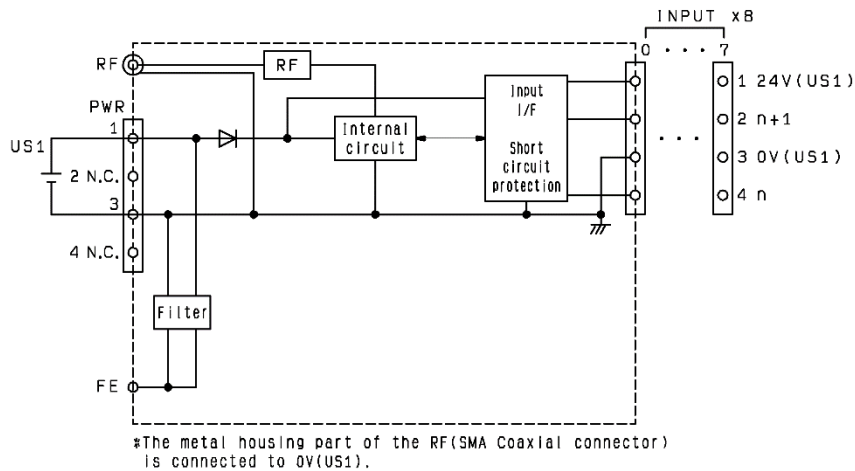

○EXW1-RDY*

PWR (power connector)

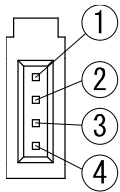

Pin number	Description
1	24V(US1)
2	24V(US2)
3	0V(US1)
4	0V(US2)

OUTPUT (connector for an output device)

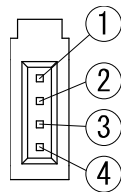

Pin number	Description
1	+COM(US2_24V)
2	n+1
3	+COM(US2_24V)
4	n

* +COM is connected to 24V (US2) inside the product as shown in the circuit diagram below.

Circuit diagram

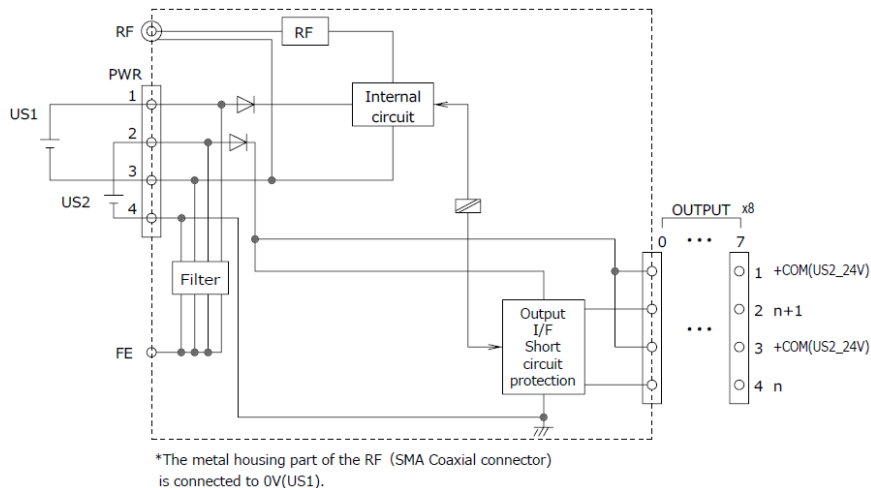

○EXW1-RDM*

PWR (power connector)

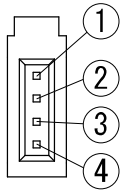

Pin number	Description
1	24V(US1)
2	24V(US2)
3	0V(US1)
4	0V(US2)

INPUT (connector for an input device)

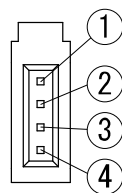

Pin number	Description
1	24V(US1)
2	n+1
3	0V(US1)
4	n

OUTPUT (connector for an output device, EXW1-RDMPE3)**

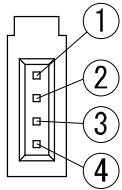

Pin number	Description
1	-COM(US2_0V)
2	n+1
3	-COM(US2_0V)
4	n

OUTPUT (connector for an output device, EXW1-RDMNE3)**

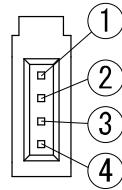

Pin number	Description
1	+COM(US2_24V)
2	n+1
3	+COM(US2_24V)
4	n

* -COM is connected to 0V (US2) and +COM to 24V (US2) inside the product as shown in the circuit diagram below.

Circuit diagram

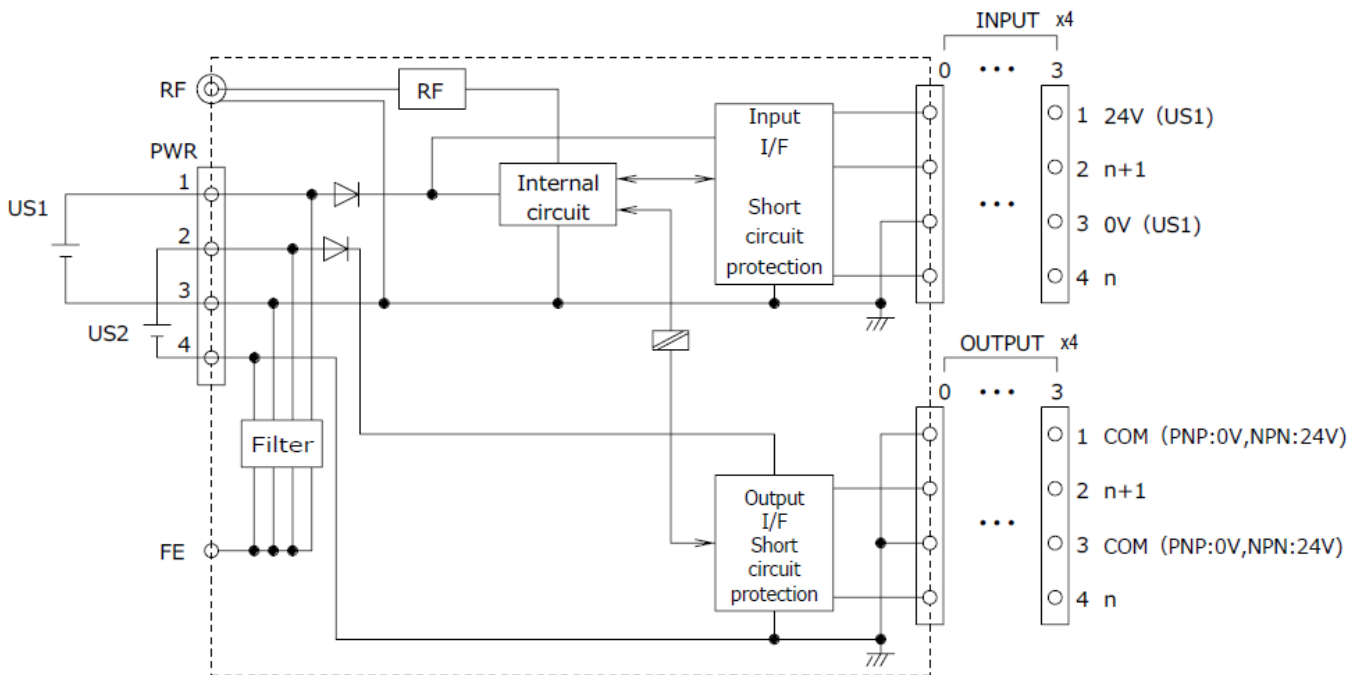

*The metal housing part of the RF (SMA Coaxial connector) is connected to 0V(US1).

Setting and Adjustment

Flow chart for operating the wireless system

■ Flow chart for using the wireless system

To use SMC wireless units (Base and Remotes), they need to be set up using an NFC reader/writer and the I/O Configurator. A setup procedure using NFC is shown below.

Refer to the operation manual for each manufacturer for how to set the controller and the PLC.

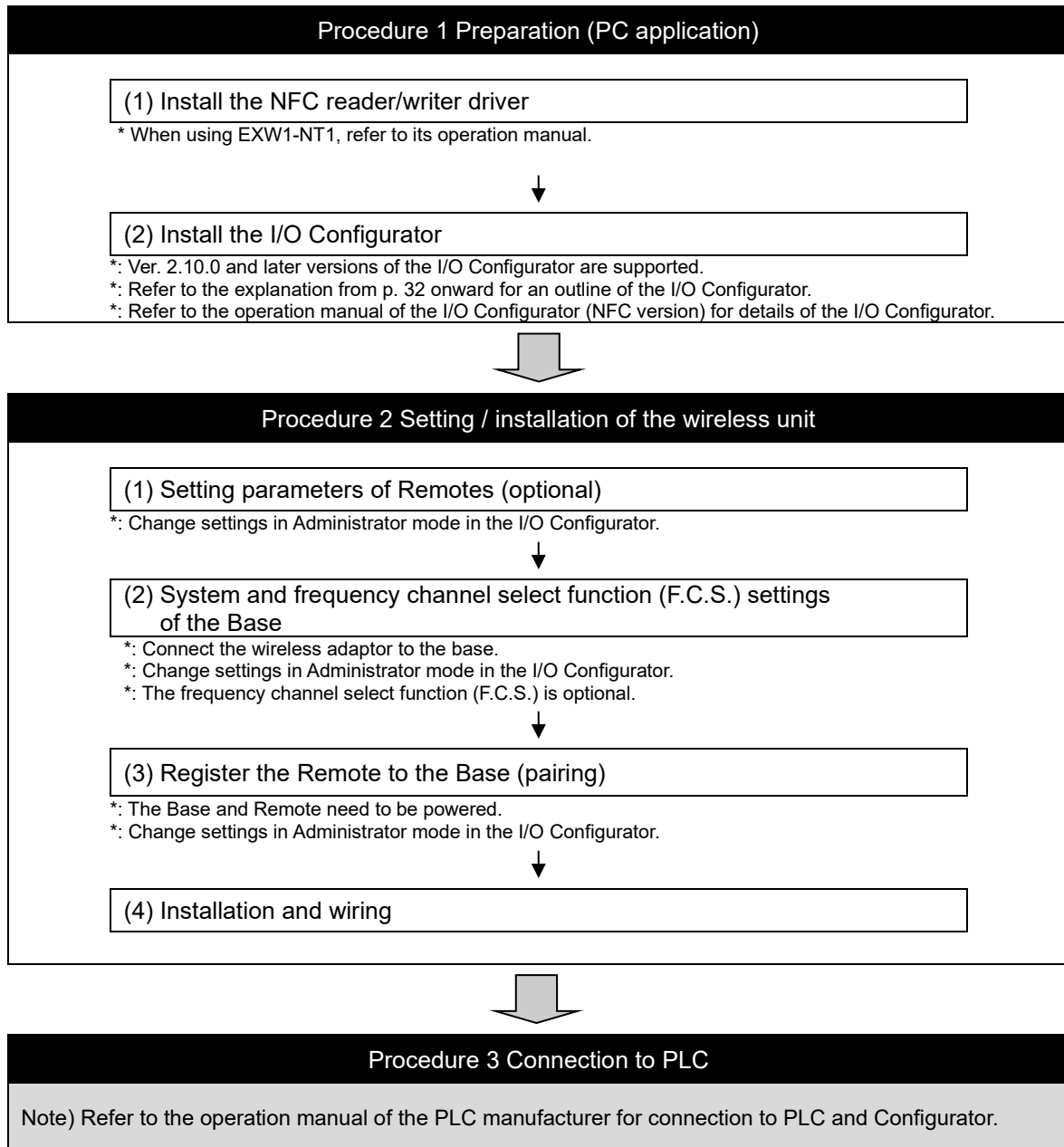

I/O Configurator (NFC version)

EXW1 series supports Ver. 2.10.0 and later versions of the I/O Configurator. In order to use the I/O Configurator (NFC version) it is necessary to install a driver etc. in advance and set the NFC reader/writer on the computer.

This section describes the installation, screen layouts and operations of the I/O Configurator (NFC version). The I/O Configurator (NFC version) can be used to check the parameter setting of the wireless unit and the contents and status of the constructed wireless system, using an NFC reader/writer and a PC.

Refer to the operation manual for the I/O Configurator (NFC version) for details of the I/O Configurator (NFC version).

■ SMC Wireless Communication System I/O Configurator (NFC version)

The I/O Configurator (NFC version) can be used to check the parameter setting of the wireless unit and the contents and status of the constructed wireless system, using an NFC reader/writer and a PC. There are two types of settable parameters which can be read or written **when no power is supplied to the product** and the parameters which can be read or written **only when power is supplied to the product**.

The figure below shows the image of connected I/O Configurator (NFC version) and wireless unit.

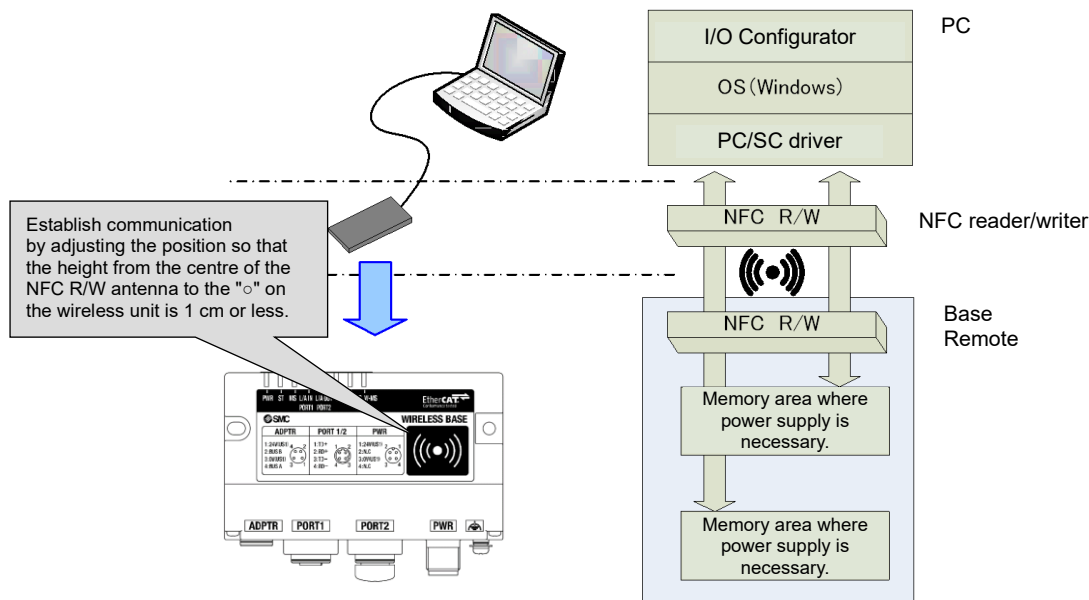

Connected I/O Configurator (NFC version) and wireless unit.



•Communication timing

The NFC communication is not accessed all the time. Therefore, **it is necessary to update the contents displayed on the screen by clicking the "Refresh button" when reading the parameters.**

The changed parameters are enabled after the product is powered on or by pressing the reset button on the I/O Configurator screen. As the parameter setting requires time for settlement, do not turn off the power supply for two seconds.

•To change the unit to be set

As the settings between the Base and Remote are different, it is necessary to update the displayed parameter by clicking the "Refresh button" on the screen of the I/O Configurator after changing the unit in which the parameters are to be set.

Preparation

Installation of the software

Driver: The following drivers should be installed before using this software.

•When EXW1-NT1 (NFC reader/writer) is used

Obtain the driver software for the NFC reader/writer from the SMC website (<https://www.smcworld.com>).

On the SMC website, select [Documents/Download] and click [Instruction Manuals].

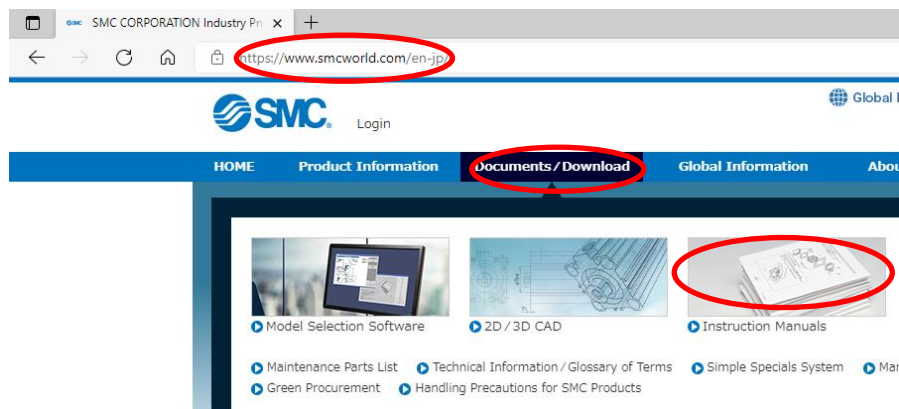

On the product search form of [Instruction Manuals], type "EXW1-NT1" to search.

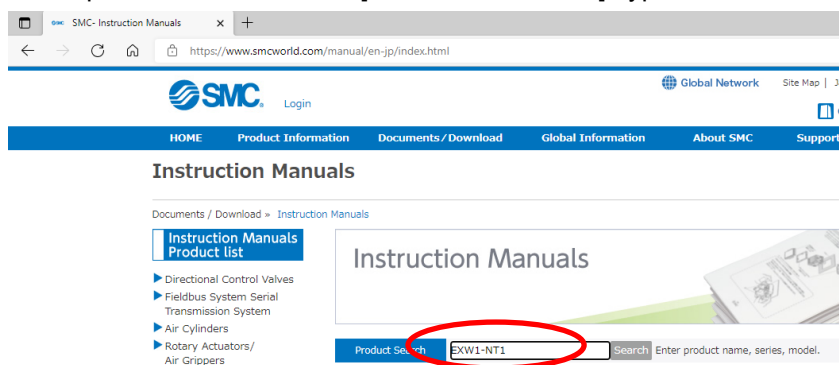

When the NFC reader / writer is held over the product, an error message may appear, such as "Device driver software was not successfully installed" or "Smart card was not identified" depending on the version of Windows OS. The reader / writer can be continuously used.

Refer to the Microsoft website (<https://support.microsoft.com/kb/976832/>).

Download the I/O Configurator (NFC version)

(1) On the SMC website (<https://www.smcworld.com>), select [Documents/Download] and click [Instruction Manuals].

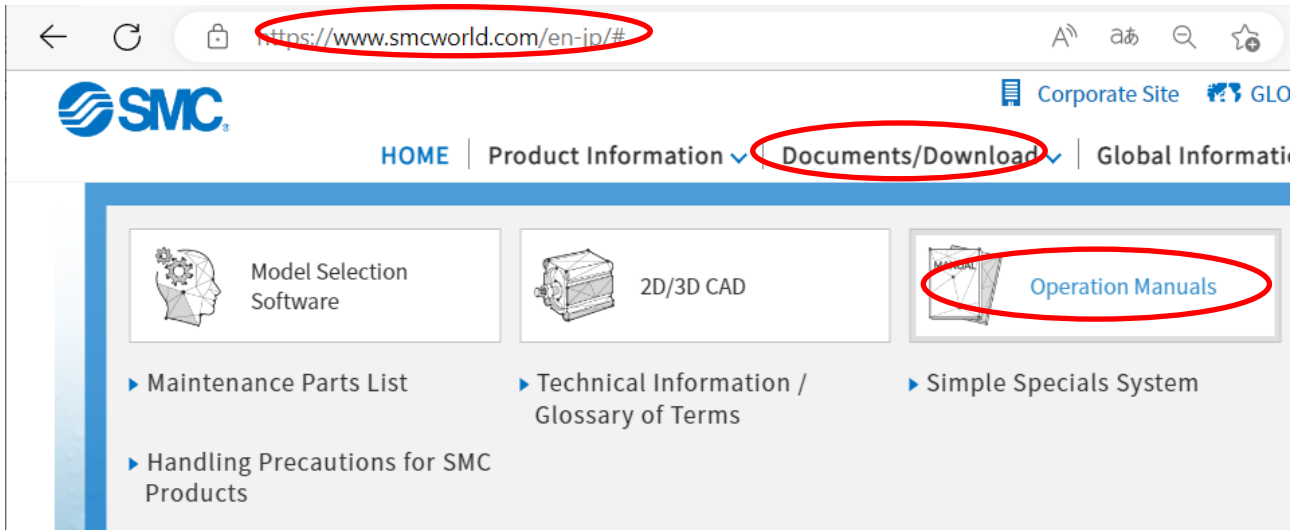

(2) Select [Fieldbus System Serial Transmission System].

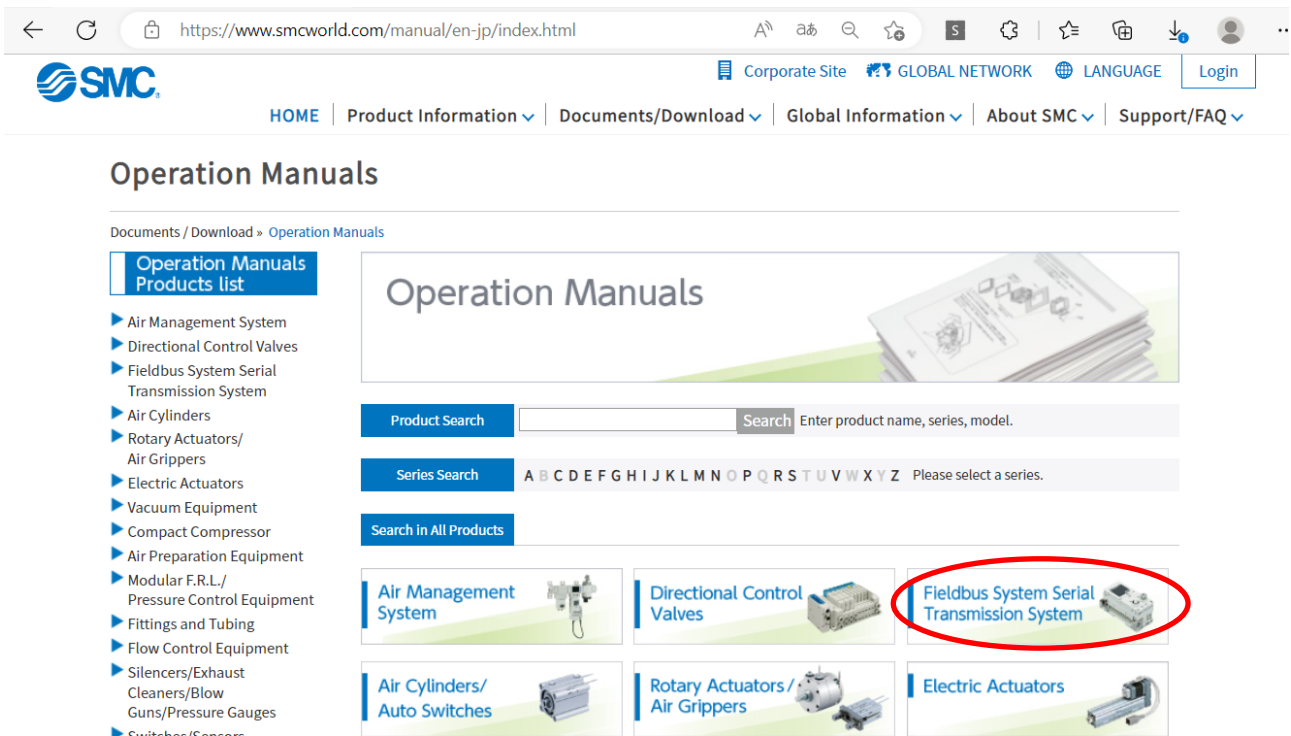

(3) Select the protocol that the product supports. (Example: "EtherCAT compatible" product)

The screenshot shows the SMC website's 'Operation Manuals' page. On the left, a navigation menu lists various protocols, with 'EtherCAT Compatible' circled in red. The main content area features a search bar and a section titled 'Fieldbus System Serial Transmission System' with a sub-section for 'CompoNet™ Compatible'.

(4) Scroll down the page of the Fieldbus System Serial Transmission System and click the Configuration File of I/O Configurator for NFC. Downloading will begin.

I/O Configurator for NFC (SMC Wireless System EX600-W/EXW1) Ver. 2.10.0	EXW1-BEC EXW1-RD # EX600-WSV Initial setting application	English Configuration File	Japanese, English, Chinese EXW1-NT1 compatible
----------------------------------------------------------------------------	----------------------------------------------------------------------	-------------------------------	-------------------------------------------------------------

Start the I/O Configurator (NFC version)

Name	Date modified	Type	Size
ini	10/19/2021 8:05 PM	File folder	
IOConfigurator.exe	10/1/2021 8:39 AM	Application	1,216 KB
Sna.NoWire.dll	10/1/2021 8:39 AM	Application exten...	27 KB

Open the downloaded file and double click the IOConfigurator.exe to start the I/O Configurator for NFC. To move IOConfigurator.exe to the desktop or another location, move the folder of the configurator, or create a shortcut of IOConfigurator.exe and invoke and use the program through it.

Screen Layouts of the I/O Configurator (NFC Version)

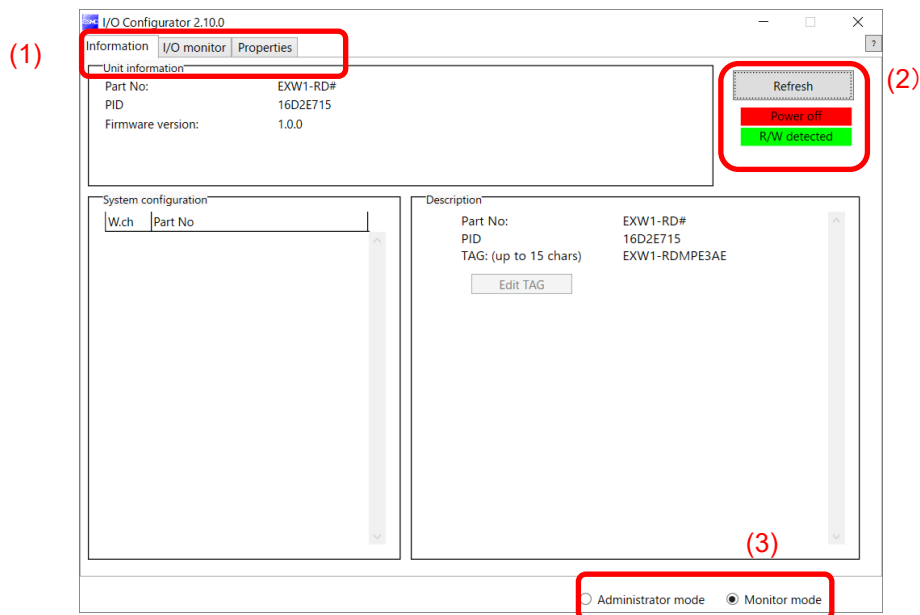

(1) Function selecting tab

I/O Configurator (NFC version) consists of three function selecting tabs.

[Information]

- Module information: Displays information on the wireless unit
- System configuration: Displays the configuration information of the Base and Remotes (connected units)
Only the system configuration of the Base is shown in tree format.
- Detailed information: Shows detailed information about the unit selected in the system configuration.

[I/O monitor]

- Input tab shows the input map information of the wireless unit.
- Output tab shows the output map information of the wireless unit.

[Properties]

- Set item: Set the parameters required to operate the Base/ Remote.

(2) Refresh, status indicators, NFC reader/writer configuration

Use these components to refresh the display of the configurator, display the power status of the module, check the connection status of the NFC reader/writer and configure the NFC reader/writer.

[Refresh]

- Clicking the refresh button while holding the NFC reader/writer to the NFC antenna approach area causes updates set in the wireless unit to be loaded. To load updates, click [Refresh].

Power status indication

- "Power supply ON" is displayed when power is supplied to the Base/Remote, and "Power supply OFF" is displayed when power is not supplied.

Connection status of the NFC reader/writer

- When the PC detects the NFC reader/writer connected to its USB port, "R/W detected" is displayed. Otherwise, "R/W not-detected" or "No driver" is displayed.

(3) Mode switching button

"I/O Configurator (NFC version)" has Administrator mode and Monitor mode.

To change parameters, operate the configurator in Administrator mode.

Administrator mode: available to change the parameters

Monitor mode: available to only read the parameters (for confirmation)

To enter Administrator mode, type a password while holding the NFC reader/writer near the NFC antenna approach area and click [Confirm].

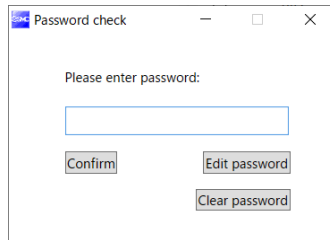

Default password: admin

If the password is forgotten, clear the password. The password will be cleared when the master factory key is entered in the [Password clear] dialog box that appears by clicking [Clear password]. Then it is possible to enter administrator mode without inputting the password.]

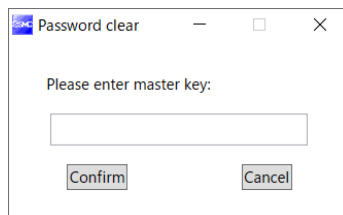

Master key: ADMIN

Any password can be set for supervisor mode. To prevent unauthorized use, it is advisable to change the default password when you first use the I/O Configurator.



- This password is not a password for the I/O Configurator (NFC version), but a password to access each unit. As such, be sure to perform a password authentication operation with an NFC reader/writer held near the NFC antenna approach area.

• **Troubleshooting**

Read error: Confirm that the NFC reader/writer is connected to the PC.

Confirm that the NFC reader/writer is held near the NFC antenna approach area.

When frozen: Remove the NFC reader/writer from the PC and connect it again.

After taking the actions above, click Refresh.

Before starting the software

<When EXW1-NT1 is used>

Follow the steps below to install the driver software. Refer to the operation manual of EXW1-NT1 for details.

●Installation of the driver software

When the PC is connected to the Internet, the driver software is automatically installed.

Install the driver software again following the steps below.

The Windows OS starts installation of the driver by connecting the EXW1-NT1 to the USB port of the PC.

(1) Windows 8.1 / 10 displays the identified devices in the task bar at the bottom of the screen.

The icon in the red circle automatically disappears when the installation of the driver software is complete.



(2) The display below appears in the Device Manager while the EXW1-NT1 is connected to the PC and is operating correctly.

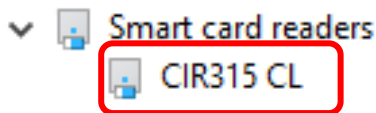

[Display of the Device Manager is incorrect]

When an exclamation mark (!) is attached to the CIR315 CL is displayed in “other device in the Device Manager”, follow the steps below.

- Right-click on the CIR315 CL, and then left-click on “driver update”.
- When the screen “start hardware update wizard ” appears, select “yes, connect only this time”, and then click “Next”.

(3) Click “automatic search for the latest driver software” for “how to search the driver software?”.

(4) When the installation does not complete successfully, take the following steps.

● Installation does not start automatically.

- (1) Download the driver software and manual referring to “Downloading of the driver software”.
- (2) Select language and press the “OK” button.

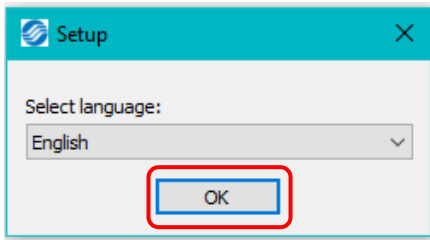

(3) Screen below appears. Press the “Next (N)” button.

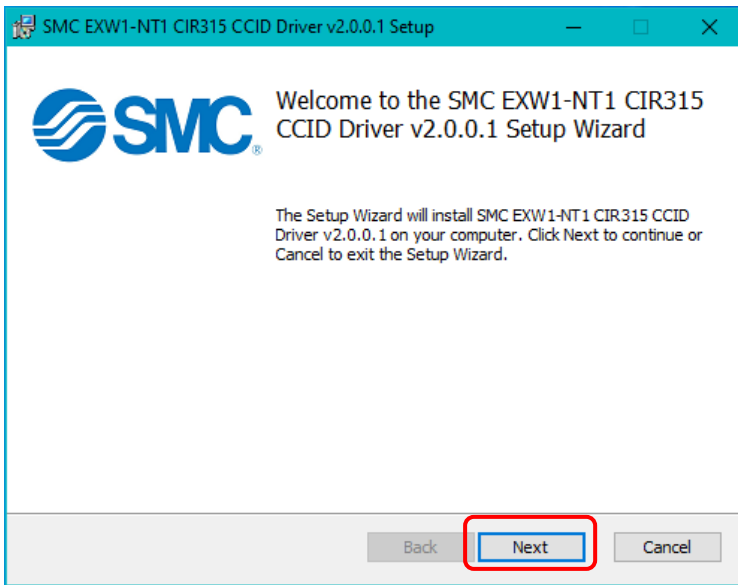

(4) Screen below appears. Press the “Next (N)” button.

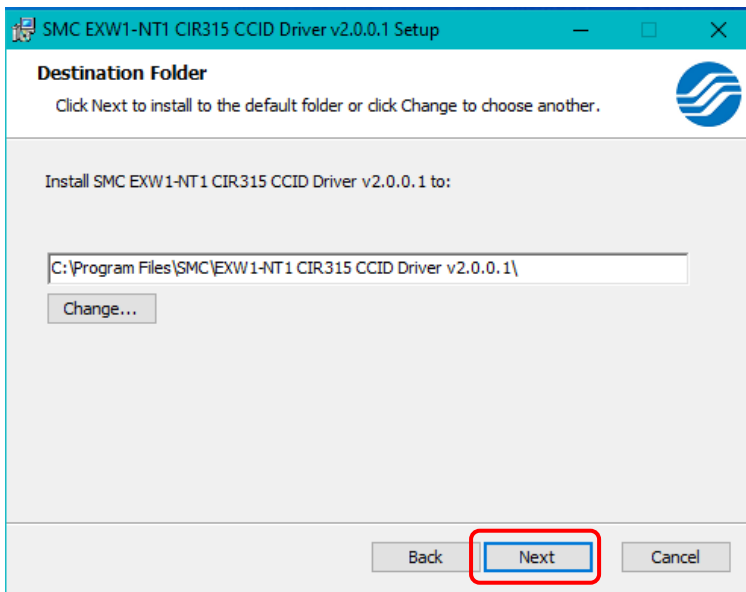

(5) Screen below appears. Press the “Install (I)” button.

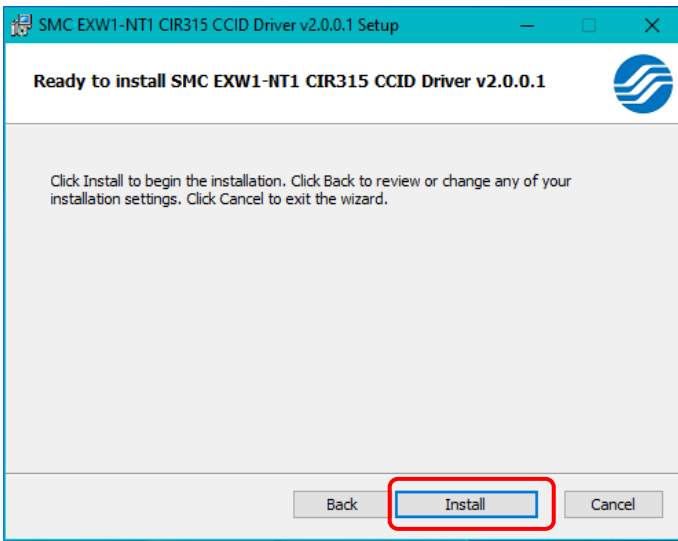

(6) The screen below appears and installation starts. Please wait.

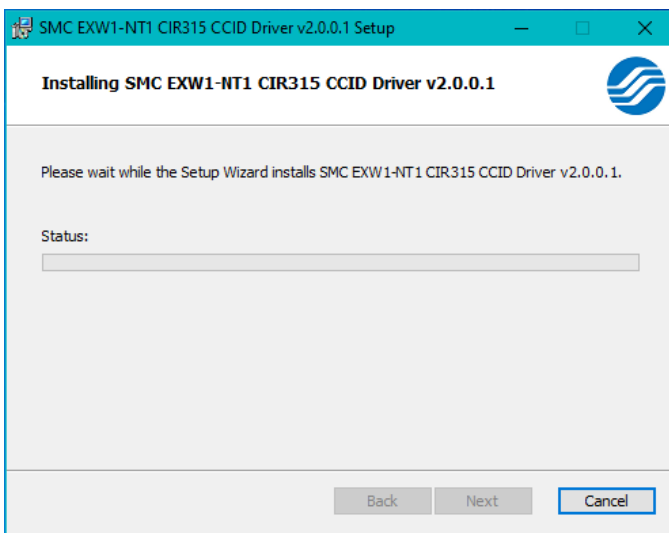

(7) The screen below appears when the installation is complete. Press the 「Finish (F)」 button.

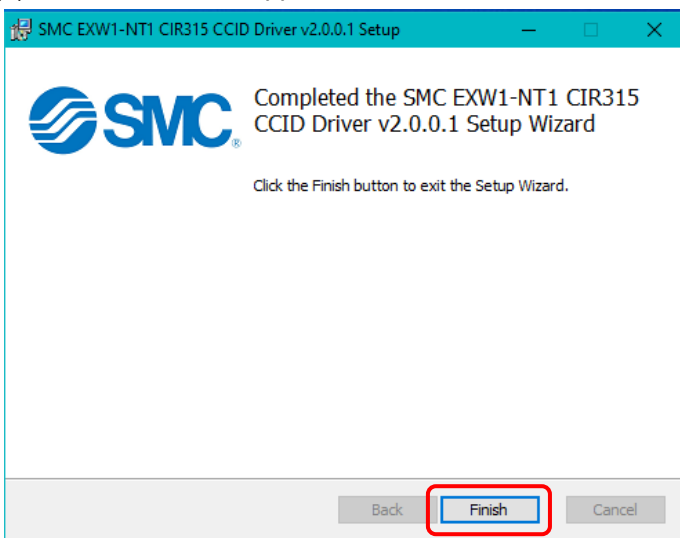

* When the screen requires restarting of the PC, restart the PC.

Monitoring and setting up

To change settings, switch to Administrator mode to operate the configurator.

In Administrator mode, a timeout occurs after 300 seconds of inactivity and the application returns to Monitor mode.

In Administrator mode, a timeout countdown is displayed to the right of the "Administrator mode" label.



Operational flow during monitoring

A rough operational flow during monitoring is shown below (operations in Monitor mode).

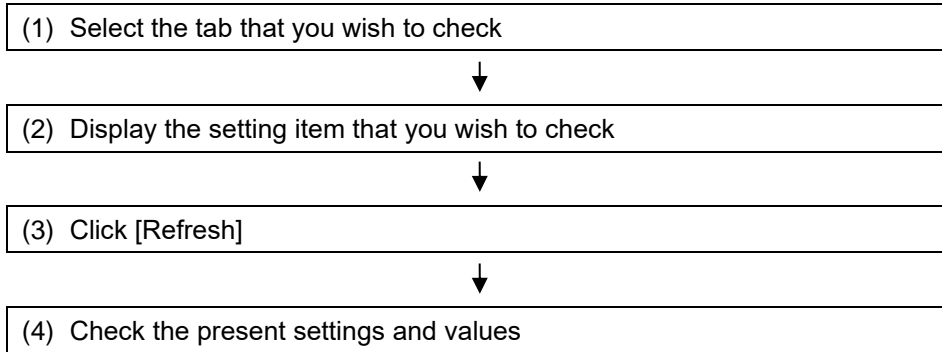

Operational flow when changing settings

A rough operational flow during setting changing operations is shown below (operations performed in Administrator mode).

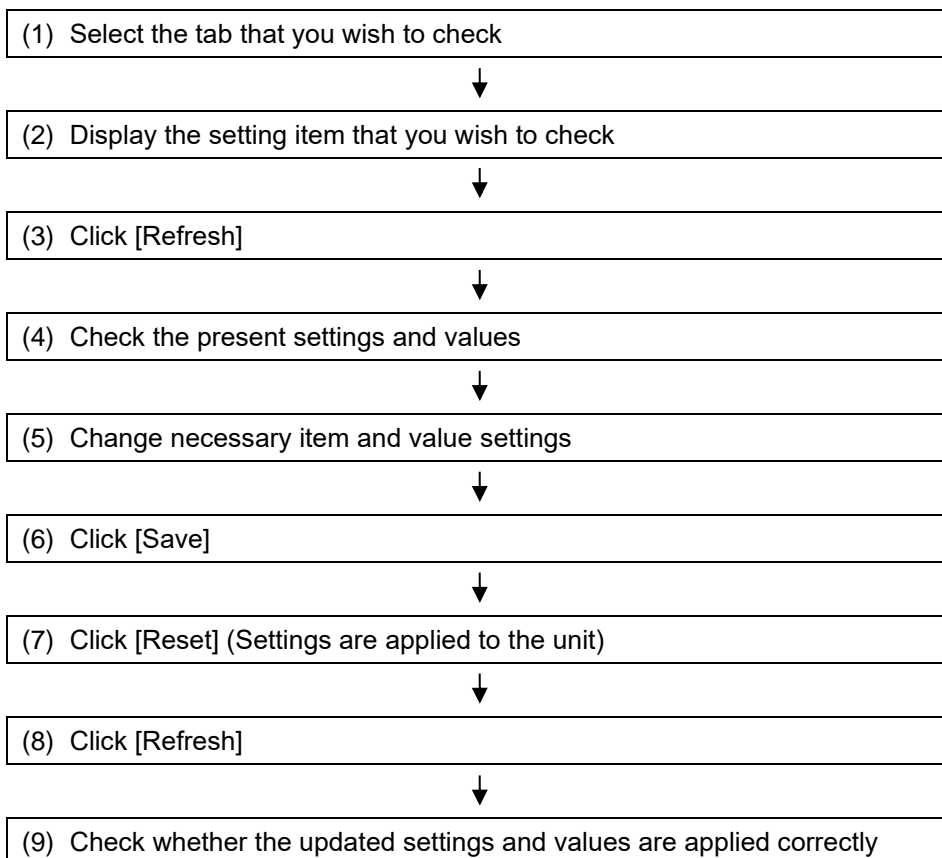

Setting/Adjustment of the Wireless Unit

Parameter settings of a Remote (optional)

Change the parameter settings of the EXW1-RD* Remote.

- Remote setting



•The setting will be applied when the Remote is turned on (or reset).

I/O Configurator 2.10.0

Information | I/O monitor | Properties

Control panel

Remote setting Import Reset module Refresh

Pairing setting Export

Power off (Red bar)

R/W detected (Green bar)

Remote setting

(1) Input size: 16 points/2 byte

(2) Output size:(includes valves) 16 points/2 byte

(3) Wireless signal: Active

(4) Power Supply Voltage Monitor (Control/Input) Enable

(5) Power Supply Voltage Monitor (Output) Disable

(6) Output action when upper communication to cut off. HOLD

(7) Output action when wireless community to cut off. HOLD

Save all

Read factory data

Product initialization

Administrator mode Monitor mode

Remote setting

	Parameter name	Set value	Initial value	Note
(1)	Module input size*	16 points (16 bits)	16 points (16 bits)	Fixed
(2)	Module output size*	16 points (16 bits)	16 points (16 bits)	Fixed
(3)	Wireless communication	Active/Idle	Active	
(4)	Detection of a drop in the US1 (for control / input) power voltage	Enable/Disable	Enable	
(5)	Detection of a drop in the US2 (for output) power voltage	Enable/Disable	Disable	Exclusive to EXW1-RDY*and EXW1-RDM*
(6)	Output while upper communication is not established	Clear/Hold	Clear	
(7)	Output while wireless communication is not established	Clear/Hold	Hold	

* Although the number of occupied inputs/outputs of EXW1-RDM* is fixed at 16 (16 bits), only the lower 8 bits are available.

(1) Module Input size

In the case of EXW1-RD*, the number is fixed at 16 (16 bits).

* Although the number of occupied inputs of EXW1-RDM* is fixed at 16 (16 bits), only the lower 8 bits are available.

(2) Module output size

In the case of EXW1-RD*, the number is fixed at 16 (16 bits).

* Although the number of occupied outputs of EXW1-RDM* is fixed at 16 (16 bits), only the lower 8 bits are available.

(3) Wireless communication

If it is set to "Idle", the wireless communication is disconnected.

(4) Detection of a drop in the US1 (for control / input) power voltage

If it is set to "Enable", a drop in the US1 (for control / input) power supply voltage can be detected.

(5) Detection of a drop in the US2 (for output) power voltage

If it is set to "Enable", a drop in the US2 (for output) power supply voltage can be detected.

(6) Output while upper communication is not established

Specify an output action for when the fieldbus communication is disconnected.

CLEAR: Clear the output.

HOLD: Fix the output at the current value.

Individual: Each output setting can be specified.

CLEAR, HOLD, SET: Output ON

(7) Output while wireless communication is not established

Specify an output action for when the wireless communication is disconnected.

CLEAR: Clear all Remote output.

HOLD : Fix all the Remote output at the current value.

Parameter settings of the Base

The following two parameter settings are available for the compact wireless Base.

- System setting
- Remote registration

System setting

Change parameter settings as required.

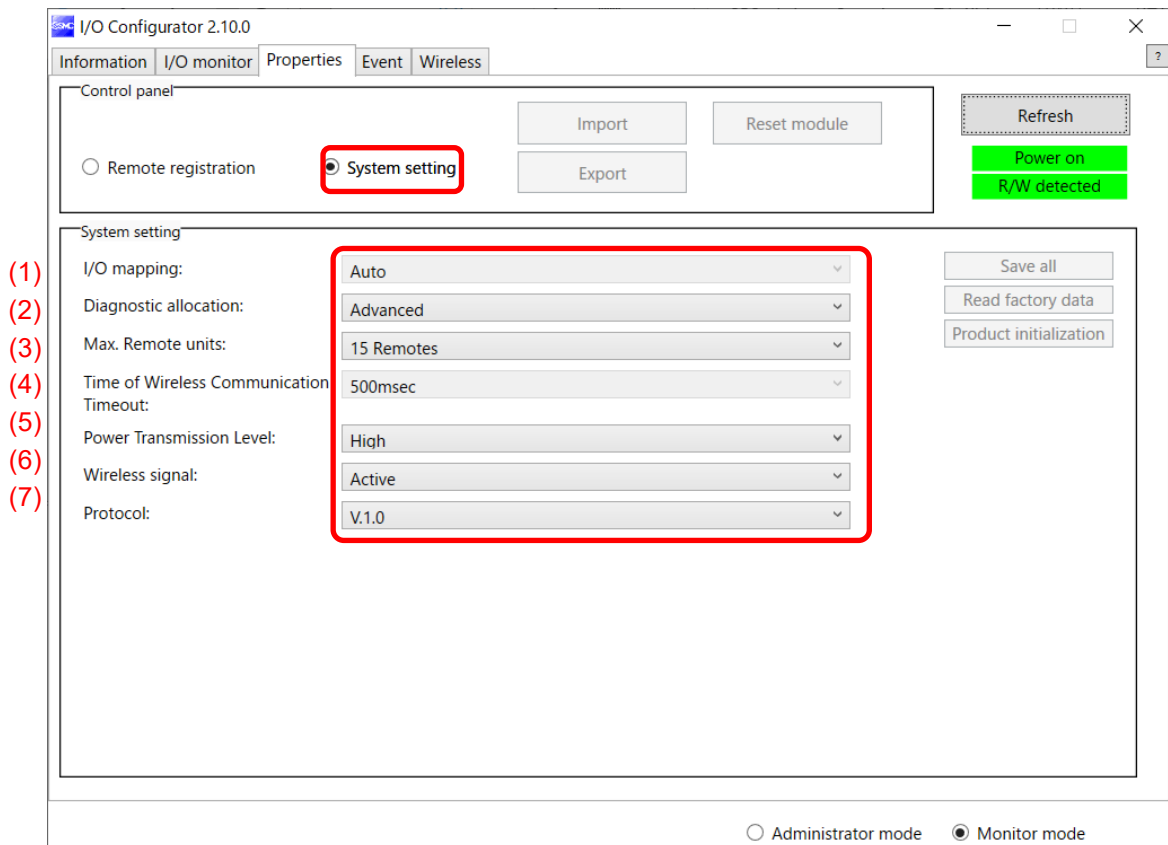

System setting parameters

Classification	Parameter	Set value	Initial value	Note
System Setting	(1) I/O mapping	Auto	Auto	
	(2) Diagnostic allocation	None/Simple/ Advanced	Advanced	
	(3) Max. Remote units	15 /31/63 Remotes	15 Remotes	
	(4) Time of Wireless communication timeout	100/200/500/1,000 msec /2,000/5,000 msec	500 msec	Activated only when protocol V.2.0 is used
	(5) Power Transmission Level	High/Middle/Low	High	Activated only when protocol V.2.0 is used
	(6) Wireless signal	Active/Idle	Active	
	(7) Protocol	V.1.0/V.2.0	V.2.0	



- The protocol version is set to V.2.0 by default; to use EX600-W series Remote devices, change the protocol version to V.1.0 before pairing them.

(1) I/O mapping

Specifies an I/O mapping method.

Setting range: Auto

(2) Diagnostic allocation

Set the diagnostic information allocated to the I/O map. (Refer to the section " Diagnostic mapping " for details.)

Setting range: None: No diagnostic data

Simple: System diagnosis

Advanced: System diagnosis + Remote connection/diagnosis/registration information

(3) Max. Remote units

Set the number of remote which are registered to the base. Wireless channels for the number of the set units are valid.

Setting range: 15/31/63

(4) Time of Wireless communication timeout

Only available in protocol V.2.0.

If wireless communication (including retries) does not succeed due to obstacles or for other reasons, it is judged to have failed after a set amount of time and disconnected. Then, the Base and the Remote are reconnected.

Setting range: 100/200/500/1,000/2,000/5,000 msec

(5) Power Transmission Level

Only available in protocol V.2.0.

It is possible to decrease interference with other wireless products by reducing the output power level. This setting is made in the base and will be applied to any paired Remotes with wireless adaptor via wireless communication.

Setting range: High/Middle/Low (Power Transmission : High > Middle > Low)

Below is an illustration image.

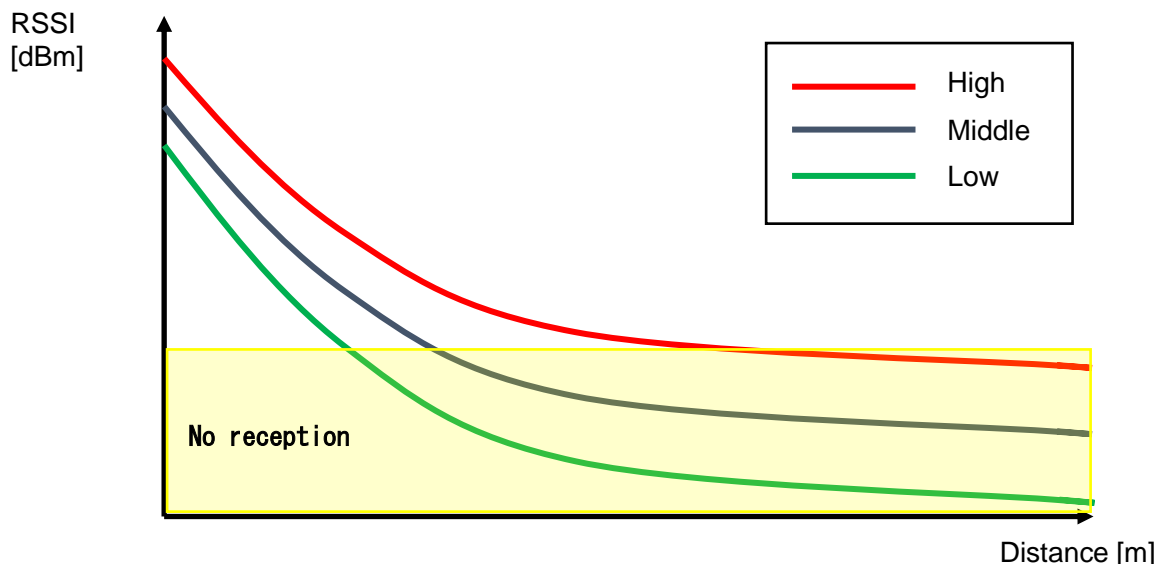

(6) Wireless communication

Sets the operation status of wireless communication.

Active: Wireless communication output is active

Idle: Wireless communication output is idle

(7) Protocol

Sets the wireless communication protocol.

* To pair with an EX600-W series unit, V.1.0 must be set.

This also applies when building a wireless system consisting of both EXW1 and EX600-W series.

•V.1.0: The same wireless communication method as EX600-W is used. The communication speed is 250 kbps.

•V.2.0: This can be applied to a wireless system consisting solely of EXW1 series units.
The communication speed is 1 Mbps.

See the table of combinations provided below.

Combination ^{*4}		Applicable function				
Wireless Base	Wireless Remote	Communication distance	Protocol	Frequency channel select function (F.C.S.)	Parameter (CoE Object)	Web function
EXW1	EXW1	Up to 100 m	V.1.0 /V.2.0	Available ^{*1}	Available ^{*1}	-
EXW1	EXW1+EX600	*2	V.1.0	NA	NA	-
EXW1	EX600	Up to 10 m	V.1.0	NA	NA	-
EX600	EXW1	Up to 10 m	V.1.0	NA	NA	Available ^{*3}
EX600	EXW1+EX600	Up to 10 m	V.1.0	NA	NA	Available ^{*3}
EX600	EX600	Up to 10 m	V.1.0	NA	NA	Available

*1: Only available in protocol V.2.0.

*2: Up to 100 m between an EXW1 series Base and Remote, and up to 10 m between an EXW1 series Base and an EX600-W series Remote.

3: The settings and monitor function are restricted when EXW1-R are used.

*4: For combinations involving EX600-W series, refer to the operation manual for the product in use.



•The protocol can be changed only when no Remote is registered in the Base.

Make changes only after unregistering any registered Remotes.

Note that an unregistration pop-up window will appear in the I/O Configurator.

Remote registration

Refer to “Pairing and Unpairing Procedures” term for the detail.

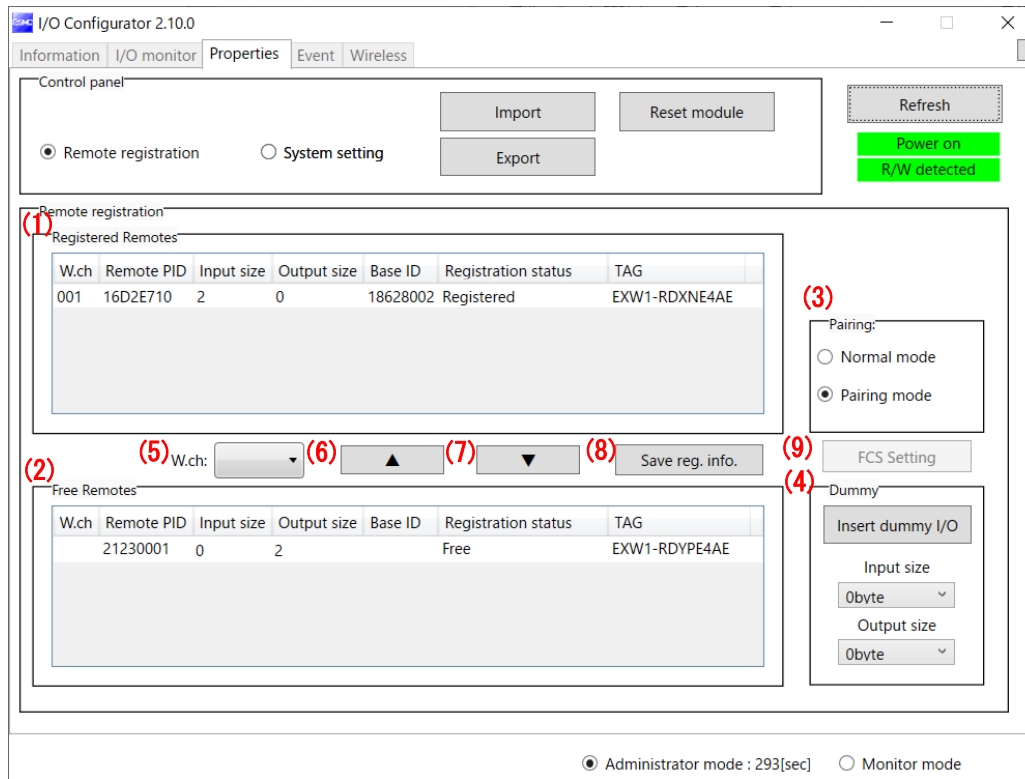

No.	Item	Description
(1)	Registered Remotes	List of remotes that are "Registered" or "Registered Wait".
(2)	Free Remotes	List of remotes that are available to be paired. * Only remotes in pairing mode can be seen.
(3)	Pairing	Select the desired mode (Normal mode / Pairing mode)
(4)	Dummy	It is possible to insert dummy remotes. Refer to the “Dummy Remote” section in “Pairing and Unpairing Procedures” for details.
(5)	W.ch	Select the wireless channel for the remote to be registered to the base
(6)	▲button	Adds remotes to the list of registered remotes. Added remotes show as “Registered Wait” until registration information is saved.
(7)	▼button	Removes remotes from the list of registered remotes.
(8)	Save reg. info.	Saves the registration information shown in the registered remotes list.
(9)	FCS Setting	Frequency Channel Selection function can be selected. * Only available in protocol V.2.0.

Frequency channel select function (F.C.S.)

The frequency channel can be selected using this function. Since only protocol V.2.0 supports it, specify protocol V.2.0 in the system settings when using it.

* The number of selectable frequency channels varies depending on the country in use. For more details, check the product number.

Number of selectable frequency channels	Applicable country
Min. 5 channels, Max. 79 channels	Certified countries except for the U.S., Canada, South Korea, Brazil, Taiwan, Argentina, and Mexico.
Min. 15 channels, Max. 79 channels	Certified countries including the U.S., Canada, South Korea, Brazil, Taiwan, Argentina, and Mexico.

* If no channel is selected, communication is established on 79 channels by default.

* For the latest information, refer to the catalog on the website below.

URL <https://www.smcworld.com>

Follow the steps below to configure the function on the Remote registration screen on the Properties tab.

(1) Set [Pairing] to [Normal mode].

For details on pairing settings, refer to Pairing and Unpairing Procedures.

(2) Click FCS Setting.

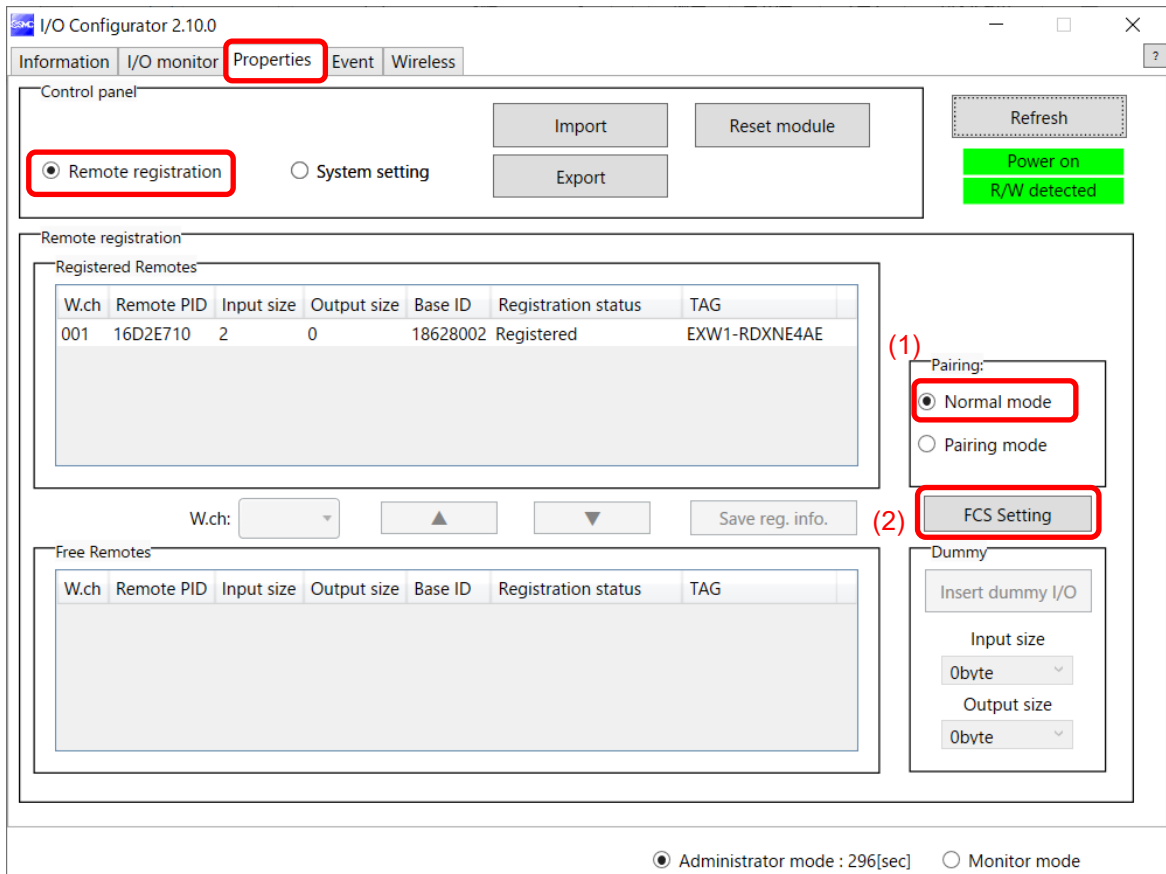

When FCS Setting is clicked, the following screen is displayed.

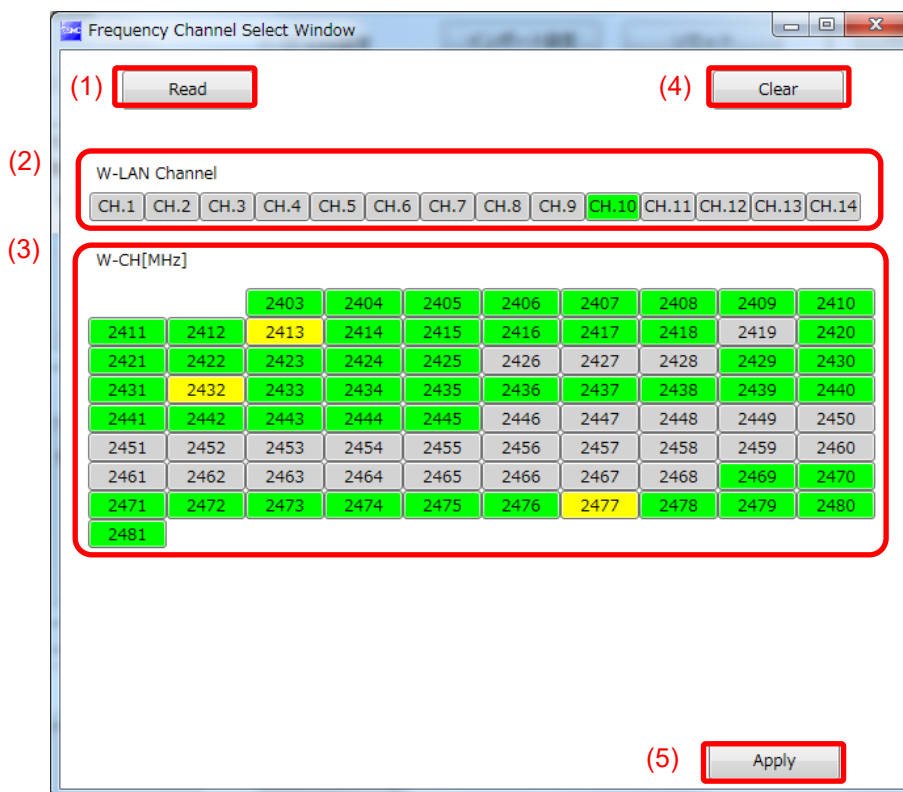

No.	Item	Description
(1)	Read button	Retrieves the current channel selection configuration.
(2)	W-LAN Channel indicators	The W-LAN indicators make it possible to select frequency channels corresponding to W-LAN channel at one time. * In the example above, W-LAN Channel: CH.10 is selected.
(3)	W-CH indicators	The W-CH indicators make it possible to select frequencies for each CH. * In the example above, frequencies 2419, 2426-2428, and 2446-2468 [MHz] are unused Channels. Note that frequencies 2446-2468 [MHz] correspond to (1) W-LAN Channel: CH.10 above.
(4)	Clear button	Select 79 frequency channels by default.
(5)	Apply button	Save the W-CH selection configuration.

•Indicator colours

Colour	Description	Remarks
Green	Active frequency channel (W-CH area) W-LAN channel that does not conflict with Active frequency channels (W-LAN Channel area)	
Yellow	Advertise channel	Cannot be set for inactive frequency channels
Grey	Inactive frequency channel	



- If advertise channels are included in the CH at the time of selecting a W-LAN Channel, they cannot be selected. To select them, initialize the product or remove all the registered Remotes and then configure F.C.S. before performing pairing.
- To use 5-7 frequency channels, neighboring frequencies need to be separated by 3 MHz.
- To use 8-14 frequency channels, neighboring frequencies need to be separated by 2 MHz.
- To use 15 frequency channels or more, neighboring frequencies can be selected.

Event

This makes it possible to check the event information of the wireless Base or wireless Remotes.
The list is sorted from newest to oldest.

I/O Configurator 2.10.0

Information I/O monitor Properties Event Wireless

(1) REMOTE Ch1 (7) CLEAR (2) EXPORT Refresh

Power on
R/W detected

TAG : EXW1-RDYNE4AE

(3) Timestamp	(4) Unit	(5) Channel	(6) Error Code
10/18/2021 4:15:47 PM	0	0	17
10/18/2021 4:15:47 PM	0	0	16
0days 00:00:30	0	0	17
0days 00:00:30	0	0	16
0days 00:00:00	0	0	17

Administrator mode Monitor mode

• Event Tab

No.	表示	内容
(1)	Model selection	Select the wireless Base or a Remote registered in the wireless Base.
(2)	Clear Event Data	Clear the event data from the selected unit in "Model selection".
(3)	Event data export	Event data can be exported to text files.
(4)	Time stamp	The time when the event was obtained is displayed. Time-synchronized time is displayed only in the case of protocol V.2.0. *Time synchronization needs to be performed by Distributed Clocks on EtherCAT protocol. If time is not synchronized, the time elapsed since the product is turned on is displayed.
(5)	Unit	The unit No. is displayed.
(6)	Channel	The channel No. of the wireless Remote is displayed.
(7)	Error Code	The error code is displayed.

(2) Error Code

The error code is displayed.

The table below shows error codes and corresponding details and diagnostics maps.

Error Code	Description	Diagnostics map		
		Item	Bit No.	
1	Detection of a short circuit of US1 or US2	System diagnostic 1	6 or 7	
2	Detection of the range upper limit		3	
3	Detection of the range lower limit		2	
6	Detection of unconnected load		5	
7	User setting upper limit detection		1	
8	User setting lower level detection		0	
9	Detection of the upper limit of the ON/OFF cycles		4	
16	Detection of US1 power supply voltage drop		System diagnosis 2	1
17	Detection of US2 power supply voltage drop			0
19	Connection failure between units (during operation)	3		
20	Connection failure between units (when power is supplied)	4		
22	Detection of system error (when power is supplied)	6		
23	Detection of hardware error (during operation)	7		
64	Abnormal number of input / output points setting error	System diagnosis 3	0	
67	Wireless adaptor internal connection error		3	
70	Detection of system error		6	
71	Detection of hardware error		7	
72	Number of system input / output points setting error	System diagnosis 4	0	
73	Number of registered Remotes setting error (Outside of the wireless channel setting range)		1	
78	Wireless registration data corrupted		6	
79	Detection of wireless hardware error		7	

Wireless

This screen displays wireless log data.

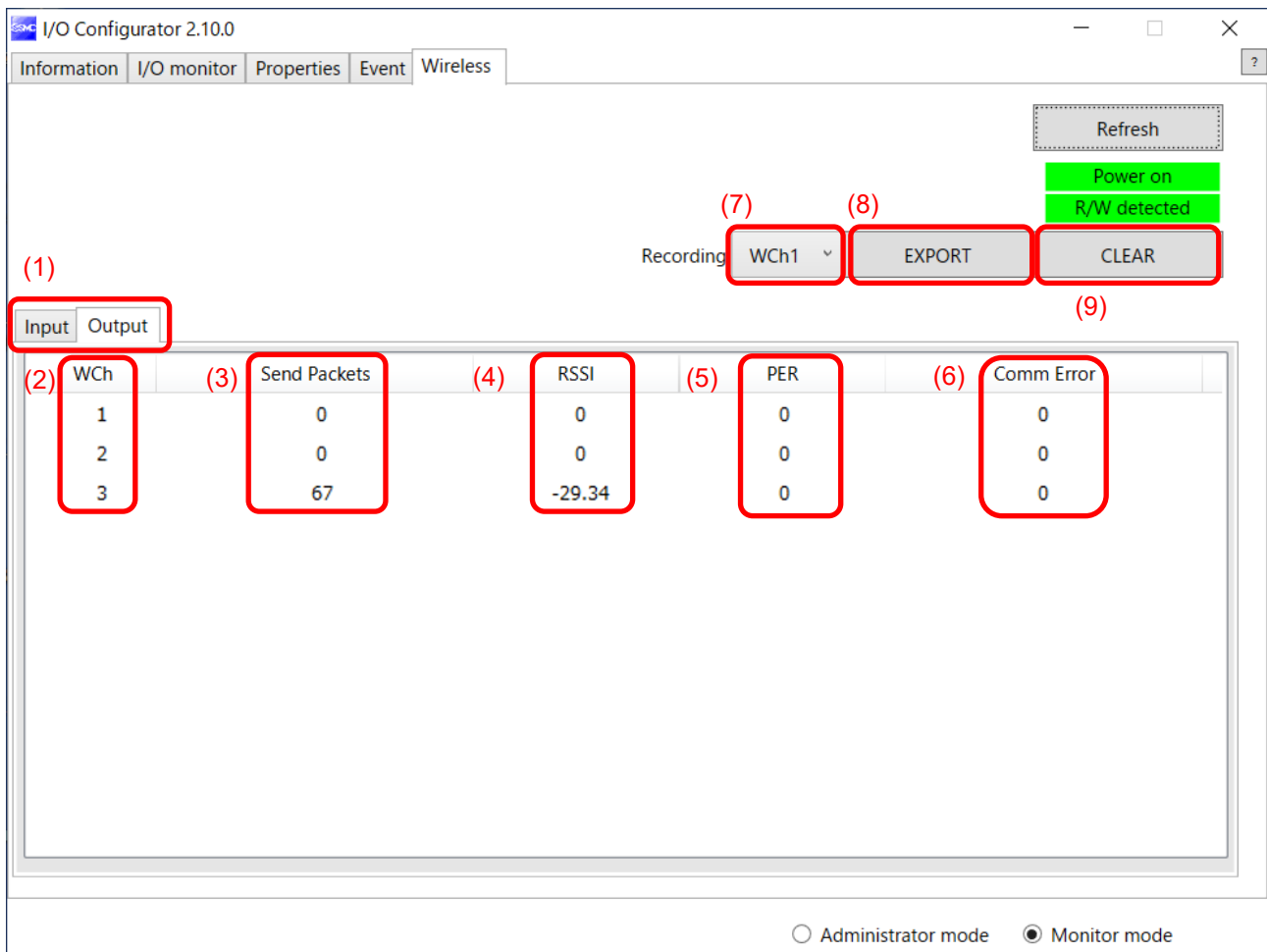





• Wireless Tab

No.	Item	内容
(1)	Input/ Output Tabs	Wireless-Based received data is displayed on the Input tab, and transmission data is displayed on the Output tab.
(2)	WCh	The wireless channel is displayed.
(3)	Send Packets (or Received Packets on the Input tab)	The number of transmitted/received packets is displayed.
(4)	RSSI (Received Signal Strength Indicator)	The radio wave receiving intensity is displayed.
(5)	PER (Packets Error Rate)	The packet error rate is displayed.
(6)	Comm Error (Communication Error)	The number of communication disconnections is displayed.
(7)	Selection of wireless channel	Select the wireless channel to obtain wireless log data.
(8)	Export of wireless log data	The wireless log data of the selected wireless channel is exported. Wireless log data is divided into four csv files.
(9)	Clear wireless log	Clear all wireless log data.

● Wireless log data file

Wireless log data is divided into four csv files as below.

Name	Date modified	Type	Size
 AllInfo.csv	2021/10/01 15:53	Microsoft Excel CS...	1 KB
 RcvRSSI.csv	2021/10/01 15:53	Microsoft Excel CS...	6 KB
 Retries.csv	2021/10/01 15:53	Microsoft Excel CS...	1 KB
 SndRSSI.csv	2021/10/01 15:53	Microsoft Excel CS...	7 KB

Pairing and Unpairing Procedures

Pairing Procedure

Pairing a Base with a Remote

Pairing is required for communication between a Base and Remote.

A Base is paired with a Remote after they are switched to pairing mode.

Pairing and registration between a Base and Remote enables wireless communication.

○Operational flow during pairing

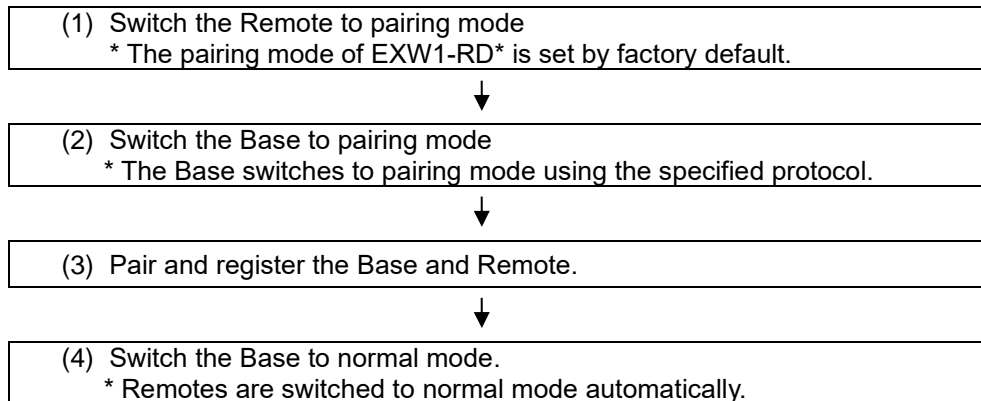

- After changing the operation mode for pairing, the mode is changed by clicking the [Reset] button or re-supplying power so that the mode will be changed to the Remote registration or listing for connection.
- If the FCS function is to be used, please perform the FCS setting prior to pairing. After pairing the advertising channels are fixed which limits the channels available for FCS setting.



- Ensure the power supply for both the base and remote is on when they are paired
- Exchange of I/O data is not possible during pairing
Do not change the pairing mode during the operation.
- Module unit size of the remote is transferred to the base unit during the pairing procedure.
When this size is changed after the pairing, please re-configure the system.

Any parameter changes are enabled after the product is powered on or by pressing the "Reset module" button.

(1) Switch the Remote to pairing mode

Connect to the Remote using NFC, select the (a) [Properties] tab and then click (b) [Refresh]. Select (d) [Pairing mode] from [Pairing setting] on the (a) [Properties] tab and then click (e) [Reset module].

Once in pairing mode, the MS LED on the unit flashes alternately in red and green.

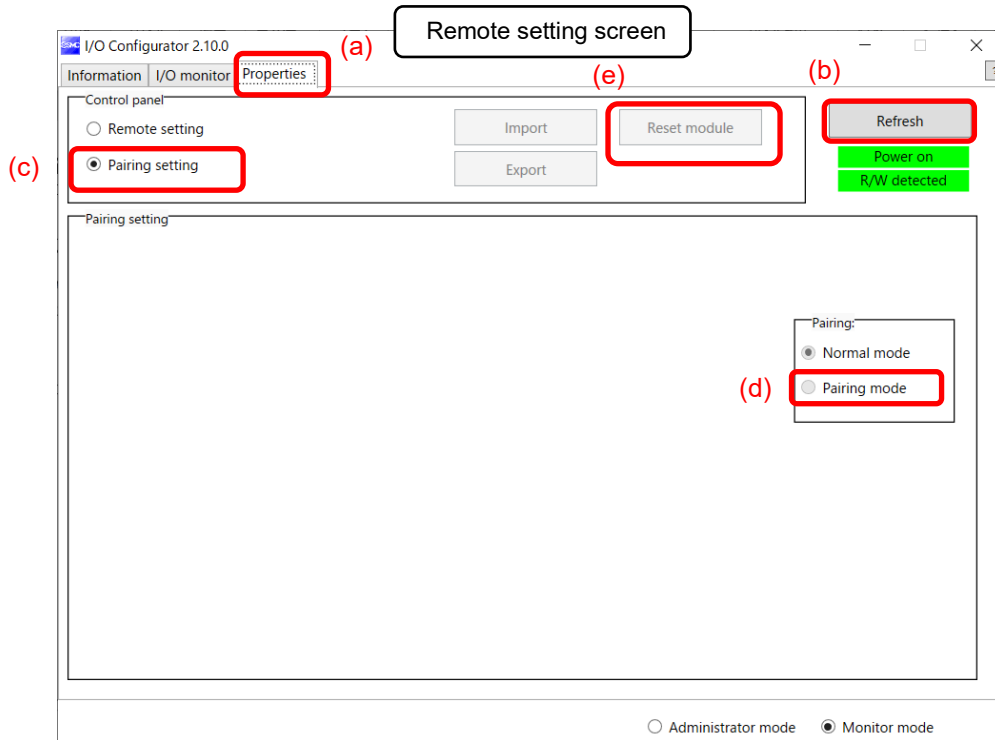

(2) Switch the Base to pairing mode

Connect to the Base using NFC, select the (a) [Properties] tab and then click (b) [Refresh].

Select (d) [Pairing mode] from (c) [Remote registration] on the (a) [Properties] tab and then click (e) [Reset module].

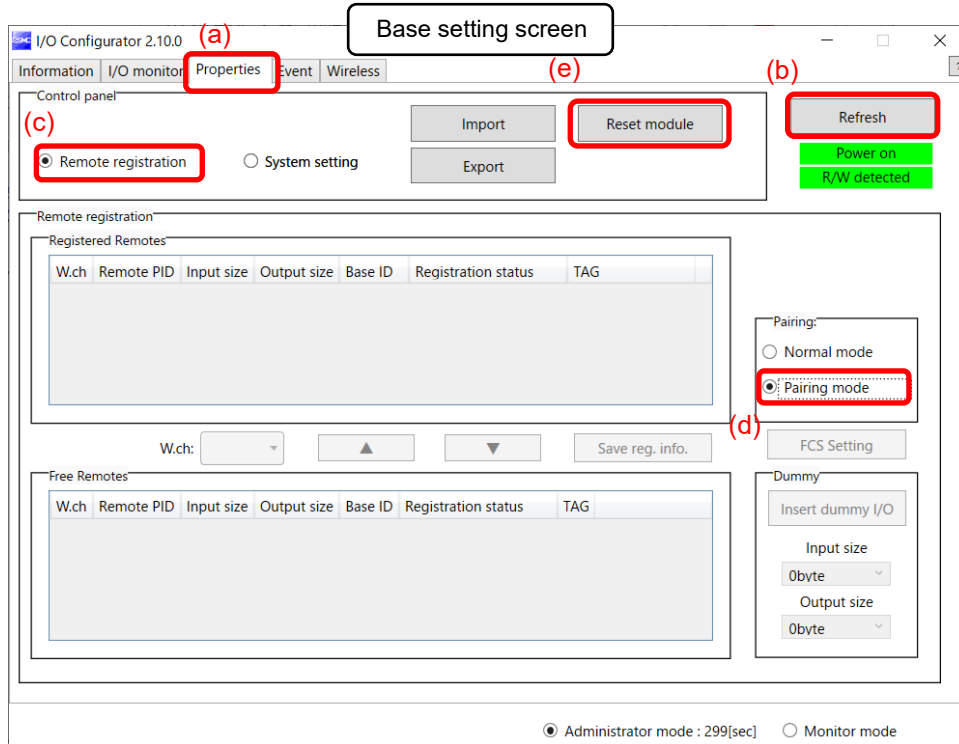

- A Base unit will change to pairing mode using the protocol set in "System setting". First set the protocol according to the Remote to be paired before switching to pairing mode.
- If the FCS function is to be used, please perform the FCS setting prior to pairing. After pairing the advertising channels are fixed which limits the channels available for FCS setting.

(3) Pair and register the Base and Remote

- (a) Clicking [Refresh] causes Remotes in pairing mode to be listed in the Free Remotes area.
- (b) Select the Remote that is to be R/stered,
- (c) specify a wireless channel and then
- (d) click ▲.

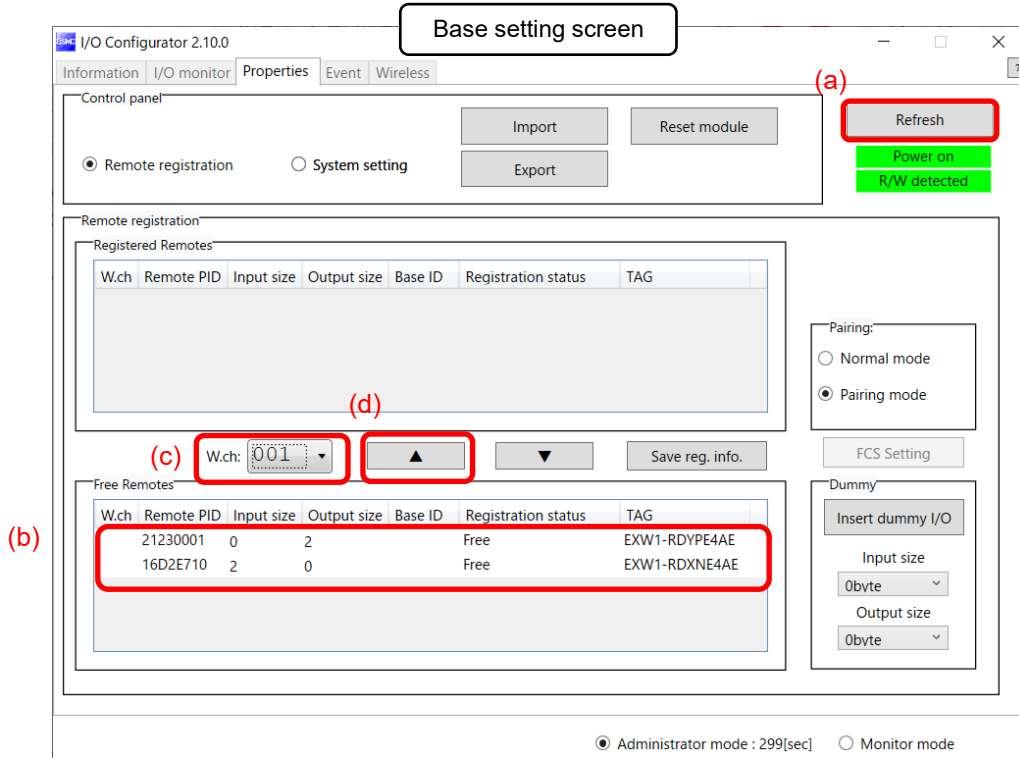

- If the Remote that you wish to pair with does not appear, click (a) [Refresh] again. If it still does not appear, check the following:
 1. The Remote is not switched to pairing mode
 2. The Remote is not turned on
 3. The Remote is registered or waiting to be registered to another Base

The Remote that is to be registered on the specified wireless channel moves to the Registered Remotes area. Make sure that the registration status is Registered Wait, and click [Save reg. info.].

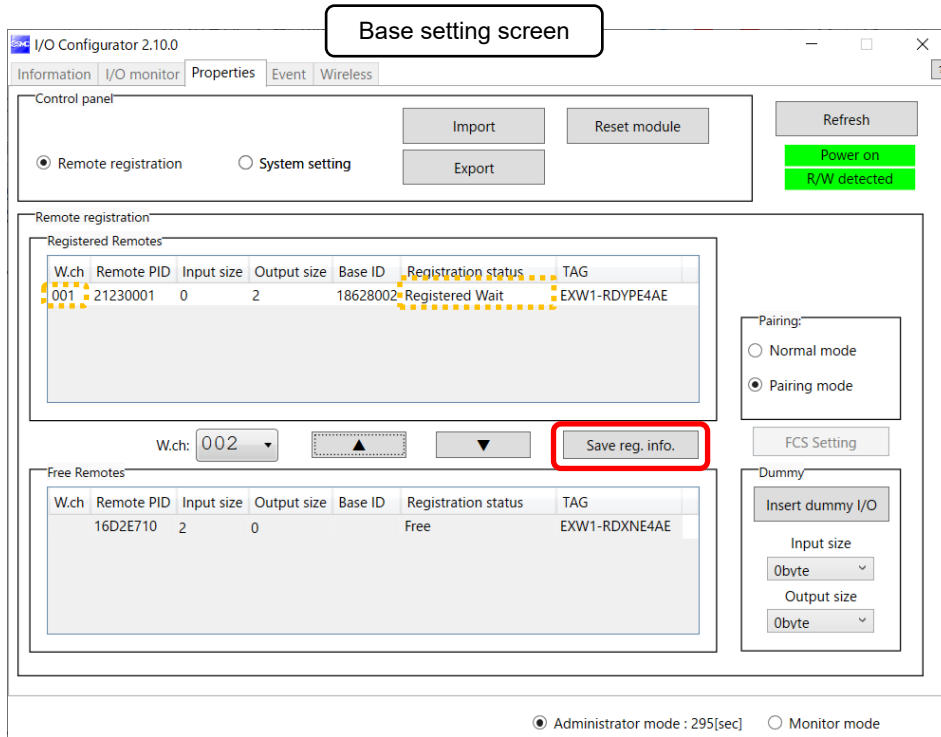

Click (a) [Reset module] and (b) [Refresh] and check that the registration status changes to Registered.

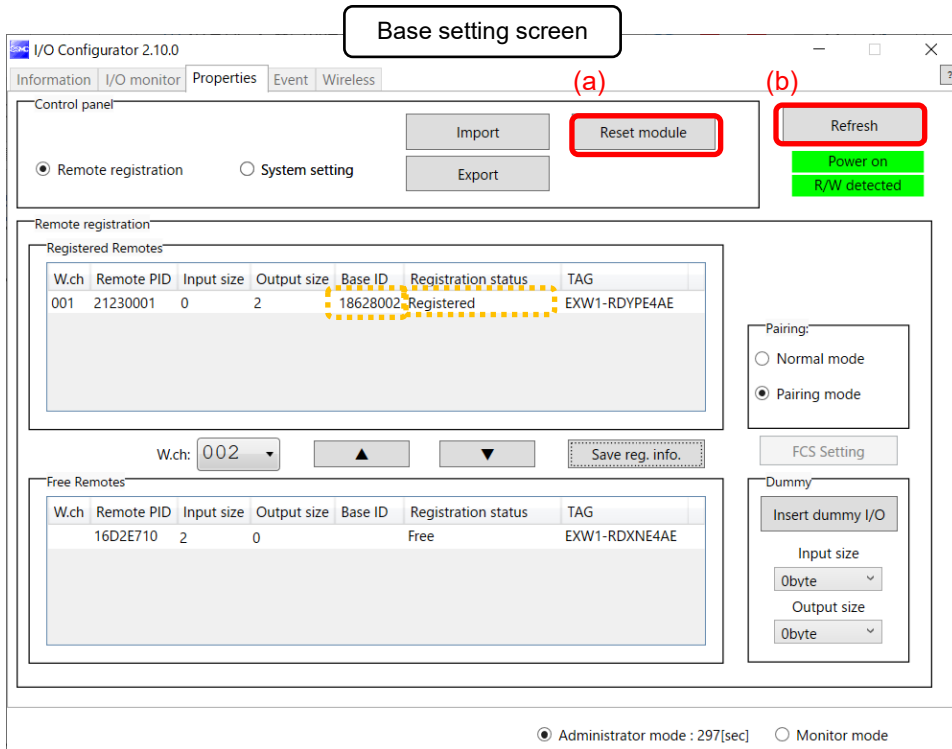

* The example below shows two Remote modules registered on CH1 and CH2.

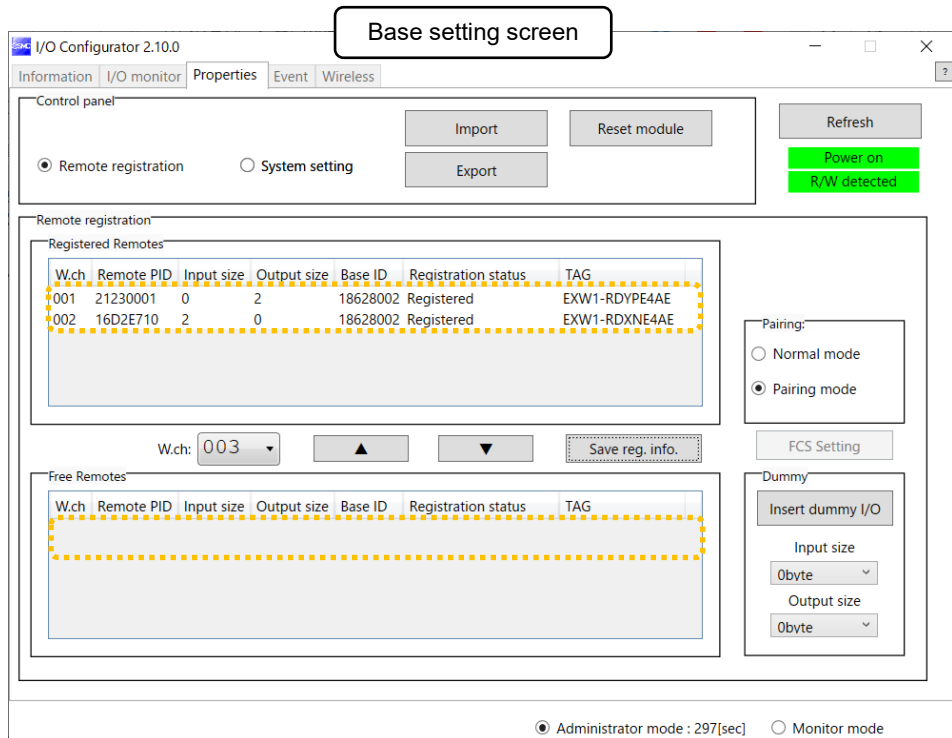

Configure the registration of the dummy Remote as necey.

- (4) Disable the Pairing mode of the Base (Normal mode)
 Connect to the Base using NFC,
 (a) Select [Normal mode]
 (b) Click [Reset module] to reset the Base.
 (c) Check connection with registered Remotes.

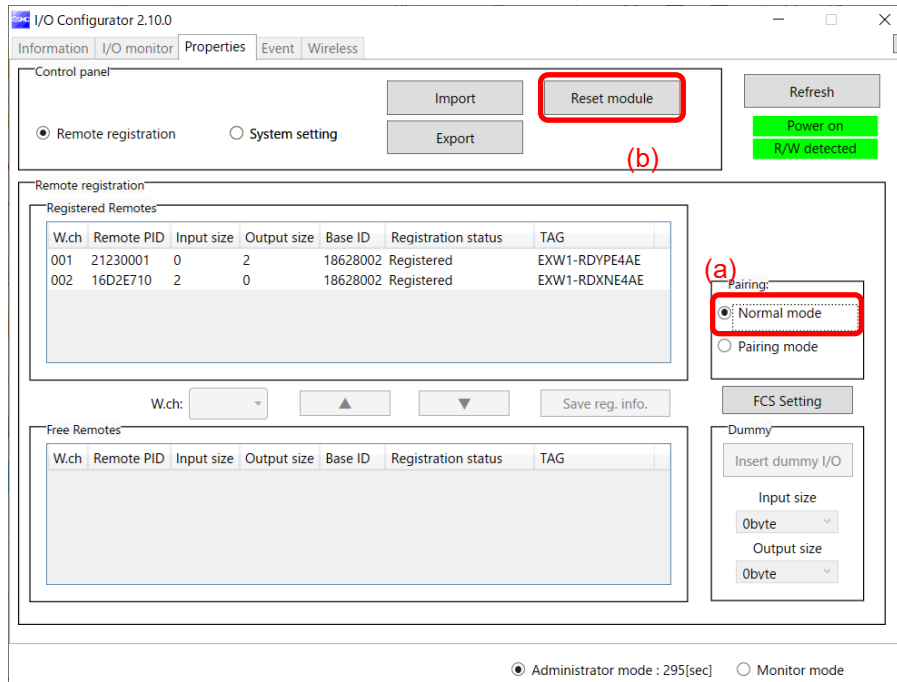

•Dummy Remote

Set dummy Remotes to secure reserved area in memory and enable Remotes to be added and registered later, without changes to mapping, even after the system has been configured. Register dummy Remotes using the Base.

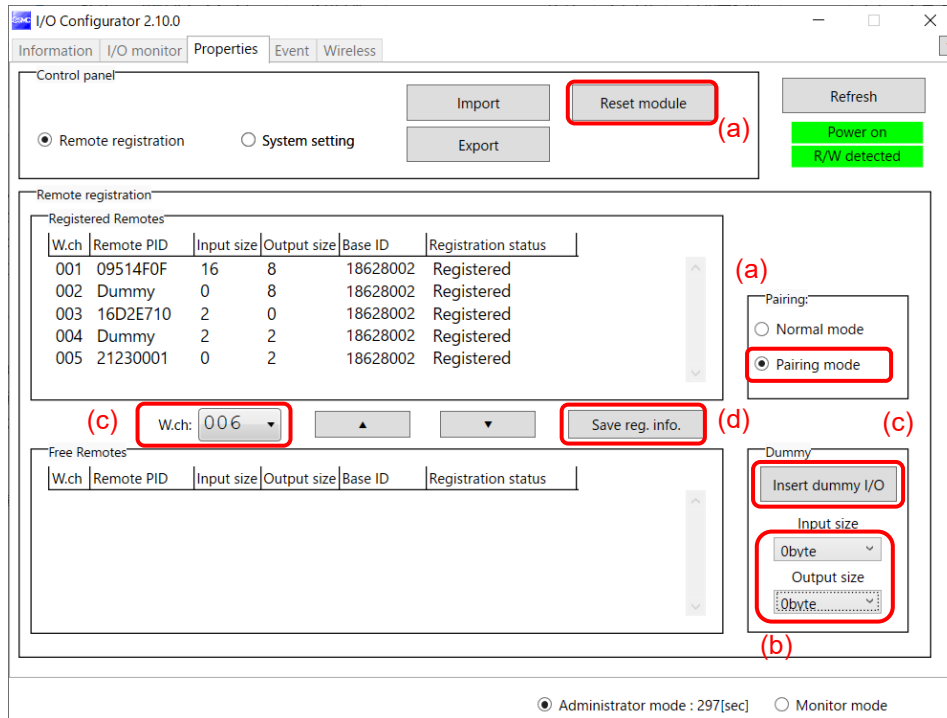

(a) **Change the operating mode** of the Wireless Base unit

- (a)-1 Set Remote registration on the Wireless Base unit to "Pairing mode".
- (a)-2 Reflect the change by clicking "Reset module" or by re-supplying power.
- (a)-3 Click the "Refresh" button to update the display.

(b) **Set inputs / outputs** of the dummy Remote

Set the number of inputs and outputs of the dummy Remote.

(c) **Allocate** the dummy Remote to the required **wireless channel**

Select the required wireless channel and click the "Insert dummy I/O" so that the set dummy Remote is displayed in the "Registered Remotes" area.

(Dummy Remote registration is not complete at this point. The status is "Registered Wait" .)

(d) **Finalize** dummy Remote **registration information**

Click the "Save reg. info." button to reflect the registered information.

(When registration has been completed successfully, the status of the dummy Remote will change to "Registered" .)



- To register a dummy Remote, it is necessary to set the number of inputs / outputs beforehand. If a Remote with inputs / outputs which are different from the set numbers is registered, the I/O map must be changed. Care should be taken.

○Switching pairing modes using a button on the Remote

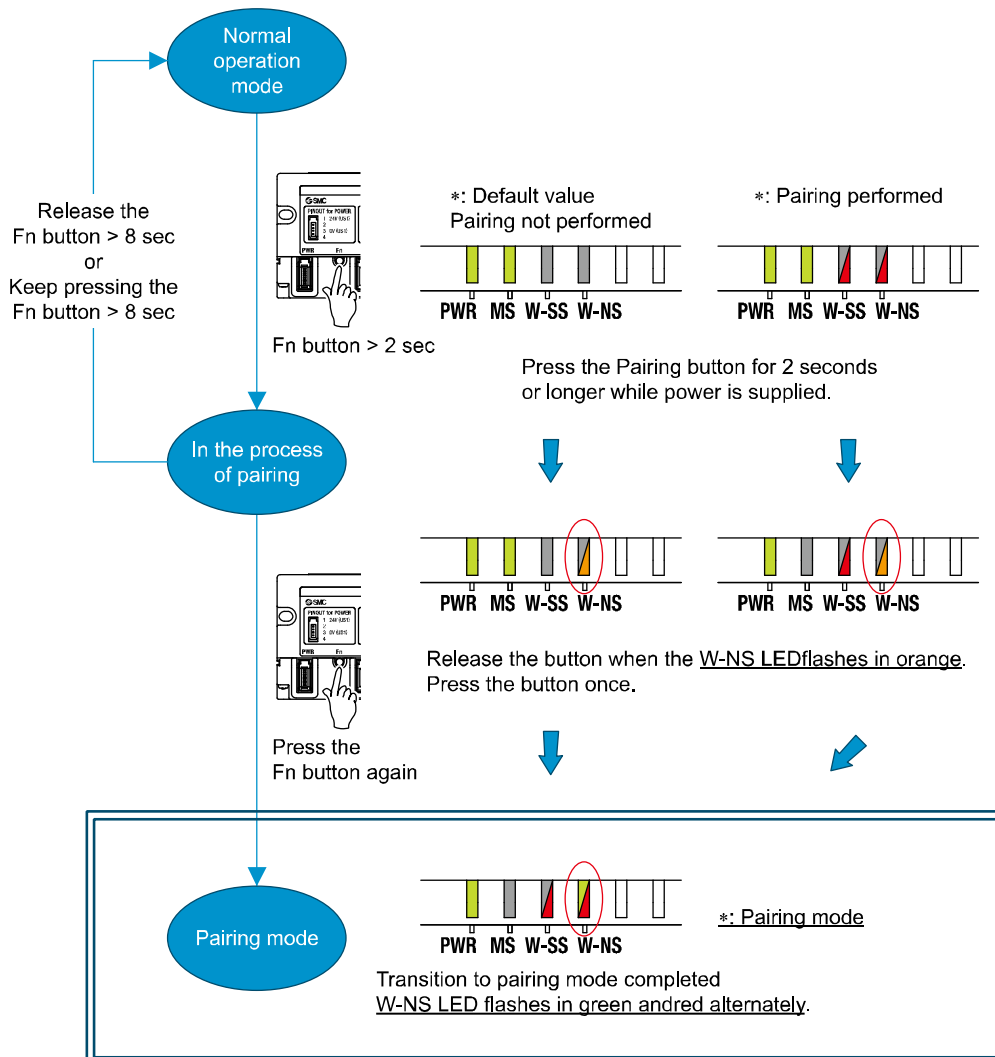

Because of the button, a Remote e-CON type does not require the NFC for switching pairing modes.

Note that the LED state above indicates that the Base is in Normal mode. When the Base is in pairing mode, W-SS lights up green or flashes

Unpairing Procedure

Removing Pairing between a Base and Remote

Pairing between a Base and Remote will be removed.

When you wish to reconfigure the wireless system, such as changing the I/O sizes of a registered Remote, pairing needs to be removed and registered again.

○Operational flow during unpairing

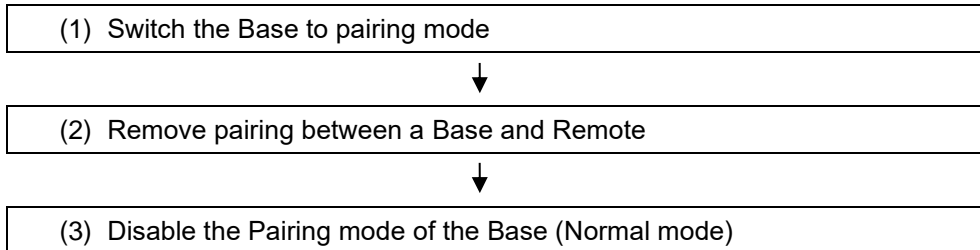

(1) Switch the Base to pairing mode

Switch the Base to pairing mode. Select the [Properties] tab and then click [Refresh]. Select [Pairing mode] from [Remote registration] on the [Properties] tab and then click [Reset]. [setting]

* The example below shows two Remote modules registered on CH1 and CH2.

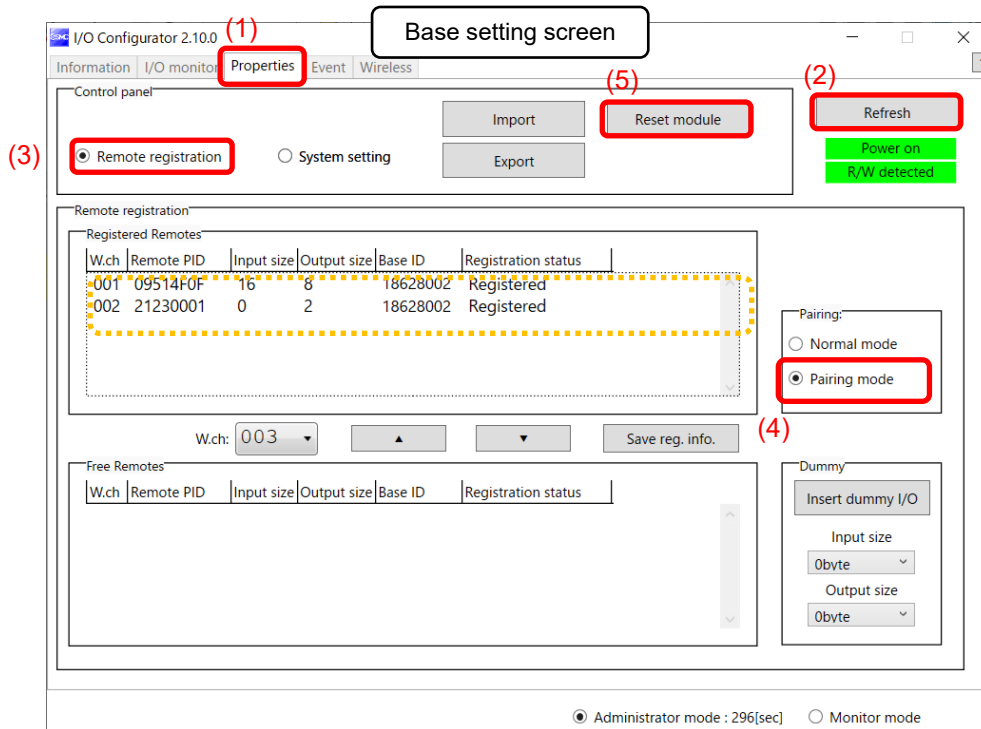

(2) Removing the pairing between the Base and Remote

Pairing between the Base and Remote will be removed.

Click [Refresh]. Select the Remote that you wish to unpair from the registered Remotes and click ▼, which in turn causes the selected Remote to move to the Free Remotes area. Clicking [Save reg. info.] finalizes the unregistration of the Remote.

! •If a Remote moved to the Free Remotes area is not in Pairing mode, clicking [Refresh] after finalizing the unregistration of the Remote causes the Remote moved to the Free Remotes area to be hidden.

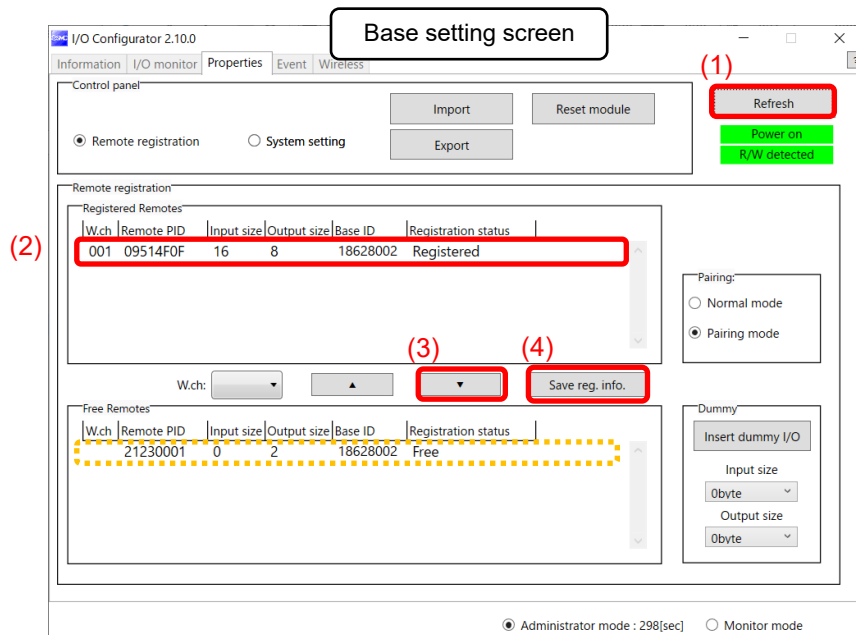

* The example below shows two Remotes unregistered.

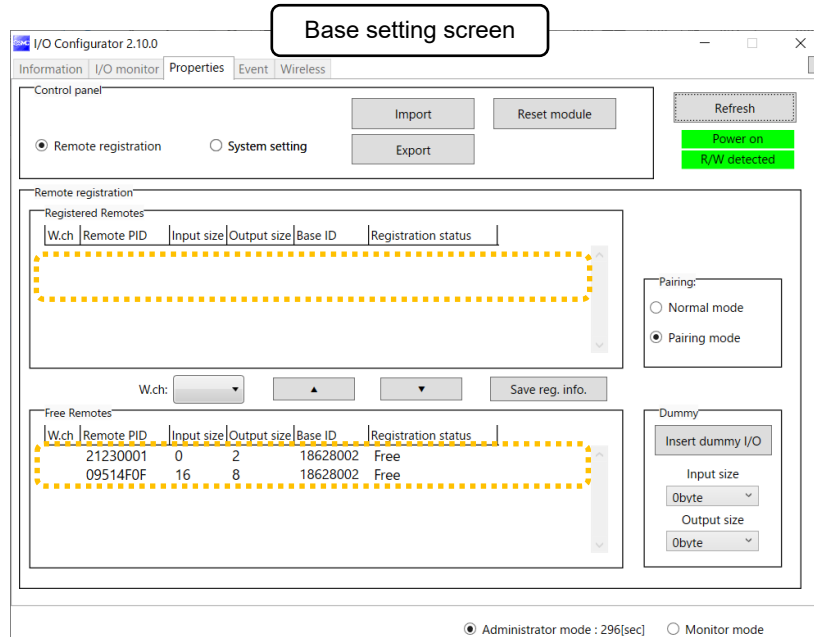

(3) Disable the Pairing mode of the Base (Normal mode)
Set the Base to [Normal mode] and click [Reset].

Mounting and Installation of Units

EXW1-BECAC, EXW1-RD*

Installation

Compact wireless Base/Remote

⚠ Caution

- To avoid damage to parts, apply the recommended tightening torque.
- Mount the product using two screws.

2 x M4 screws are required (Recommended torque = 0.8+/-10% N·m).

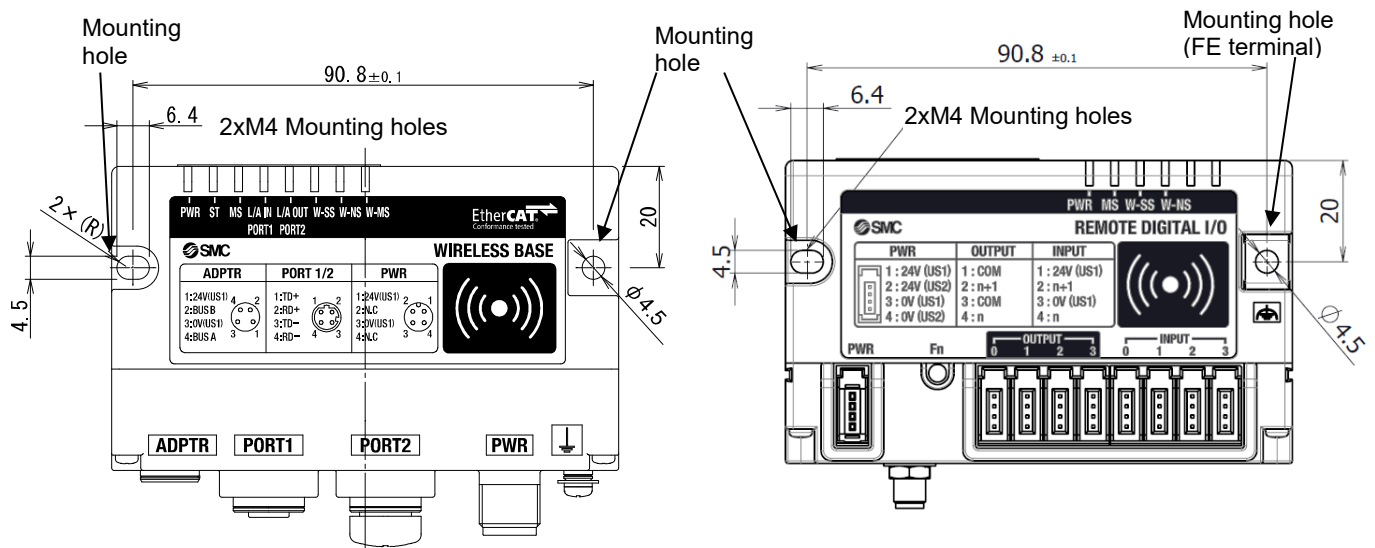

■ Wireless adaptor

⚠ Caution

- To avoid damage to parts, apply the recommended tightening torque.
- Refer to the operation manual of the Wireless Adaptor for details.

· Integrated type (installation)

(1) Connection of the base and installation plate

Secure the installation plate to the base using the two self-tapping screws (M3 x 8) included with the wireless adaptor.

The tightening torque should be $0.4 \text{ N}\cdot\text{m} \pm 10\%$.

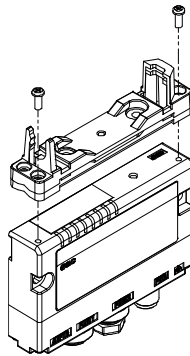

(2) Installation of wireless adaptor

Clip the wireless adaptor onto the installation plate as shown below and secure the adaptor in place using the M10 nut already fitted to the wireless adaptor.

The recommended tightening torque is $0.9 \text{ N}\cdot\text{m} \pm 10\%$.

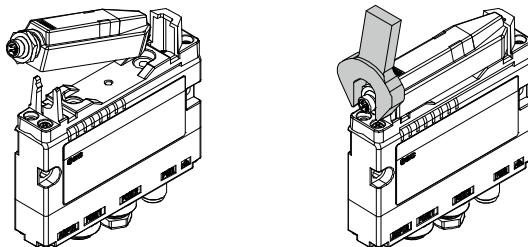

(3) Connecting the cable for the wireless adaptor

Follow the procedure below to connect the cable for the wireless adaptor.

- (1) Connect the U-side connector of the cable to the base.
- (2) Connect the S-side connector of the cable to the adaptor.

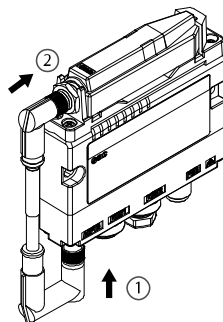

· Flat surface mounting

(1) Attachment of installation plate

Attach the installation plate to the target object by either of the following two methods.

Installation with M3 x 4 positions

The tightening torque should be $0.4 \text{ N}\cdot\text{m} \pm 10\%$.

(Mounting screws are not included.)

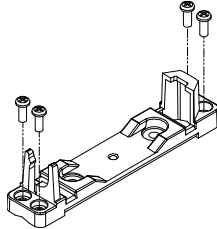

Installation with M4 x 2 positions

The tightening torque should be $0.6 \text{ N}\cdot\text{m} \pm 10\%$.

(Mounting screws are not included.)

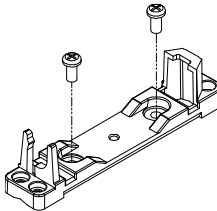

(2) Installation of wireless adaptor

Clip the wireless adaptor onto the installation plate as shown below and secure the adaptor in place using the M10 nut already fitted to the wireless adaptor.

The recommended tightening torque is $0.9 \text{ N}\cdot\text{m} \pm 10\%$.

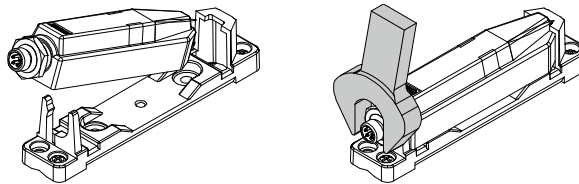

(3) Connection of the cable for wireless adaptor

Connect the cable to the base and the wireless adaptor.

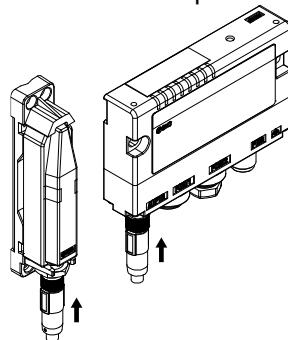

●Curved surface mounting

(1) Thread the top and bottom cable ties through the installation plate.

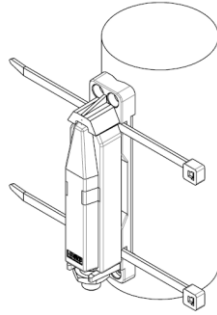

(2) Secure the wireless adaptor to the mount by tightening the cable ties. Trim back the loose ends of the cable ties.

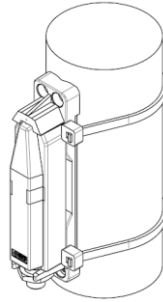

External Antenna

Caution

- avoid damage to parts, apply the recommended tightening torque.

2 x M4 screws are required (Recommended torque = $1.3 \pm 10\%$ N·m).

Refer to the operation manual attached to the external antenna set for details.

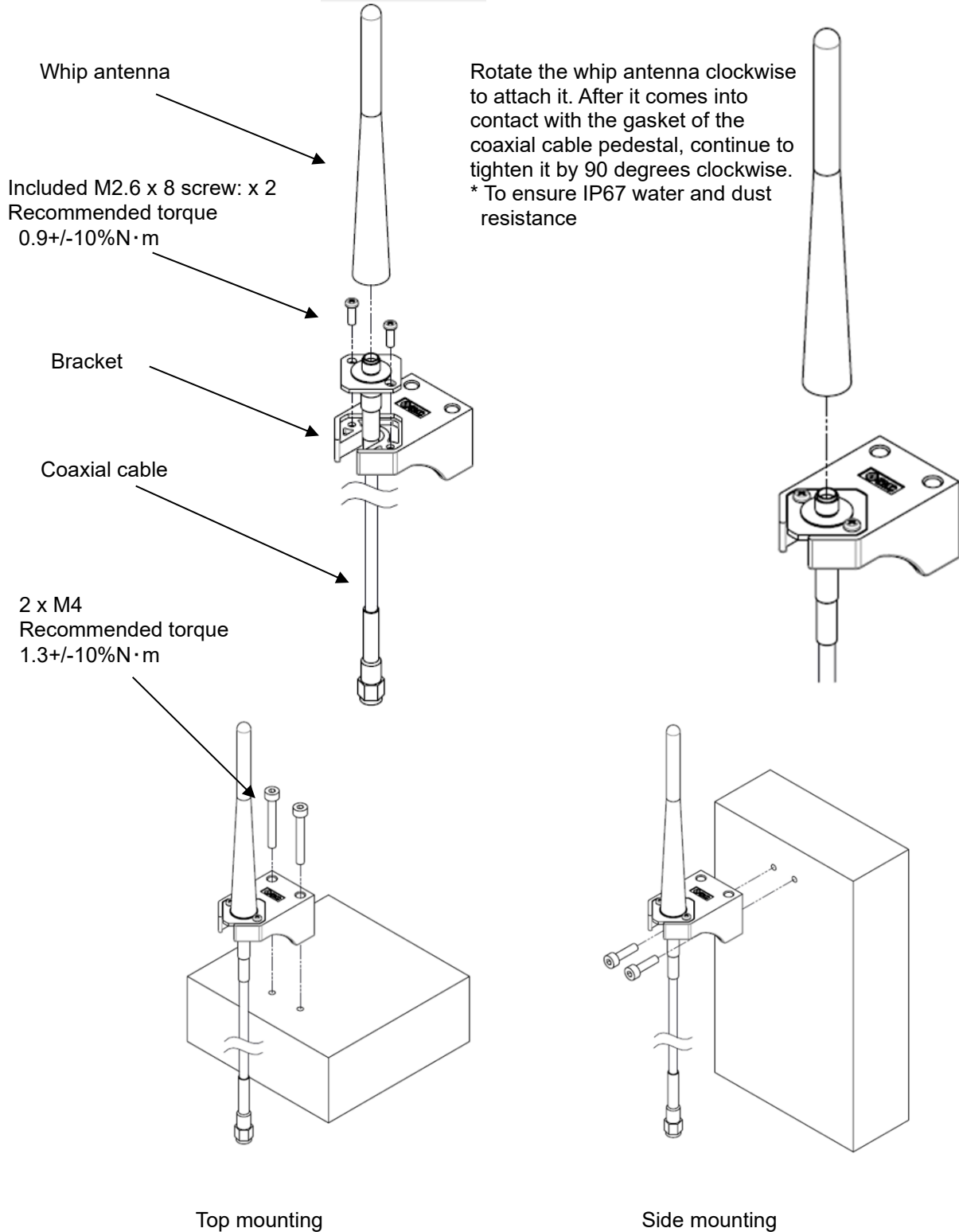

Attach the male connector of the coaxial cable to the antenna connector of the wireless unit by rotating it clockwise. (Tightening torque $0.9 \pm 10\% \text{ N} \cdot \text{m}$)

To install the wireless unit inside a distribution box or other container, pass the coaxial cable through a rubber bushing and into the box in which the wireless unit is installed, and attach its connector to the antenna connector of the wireless unit.

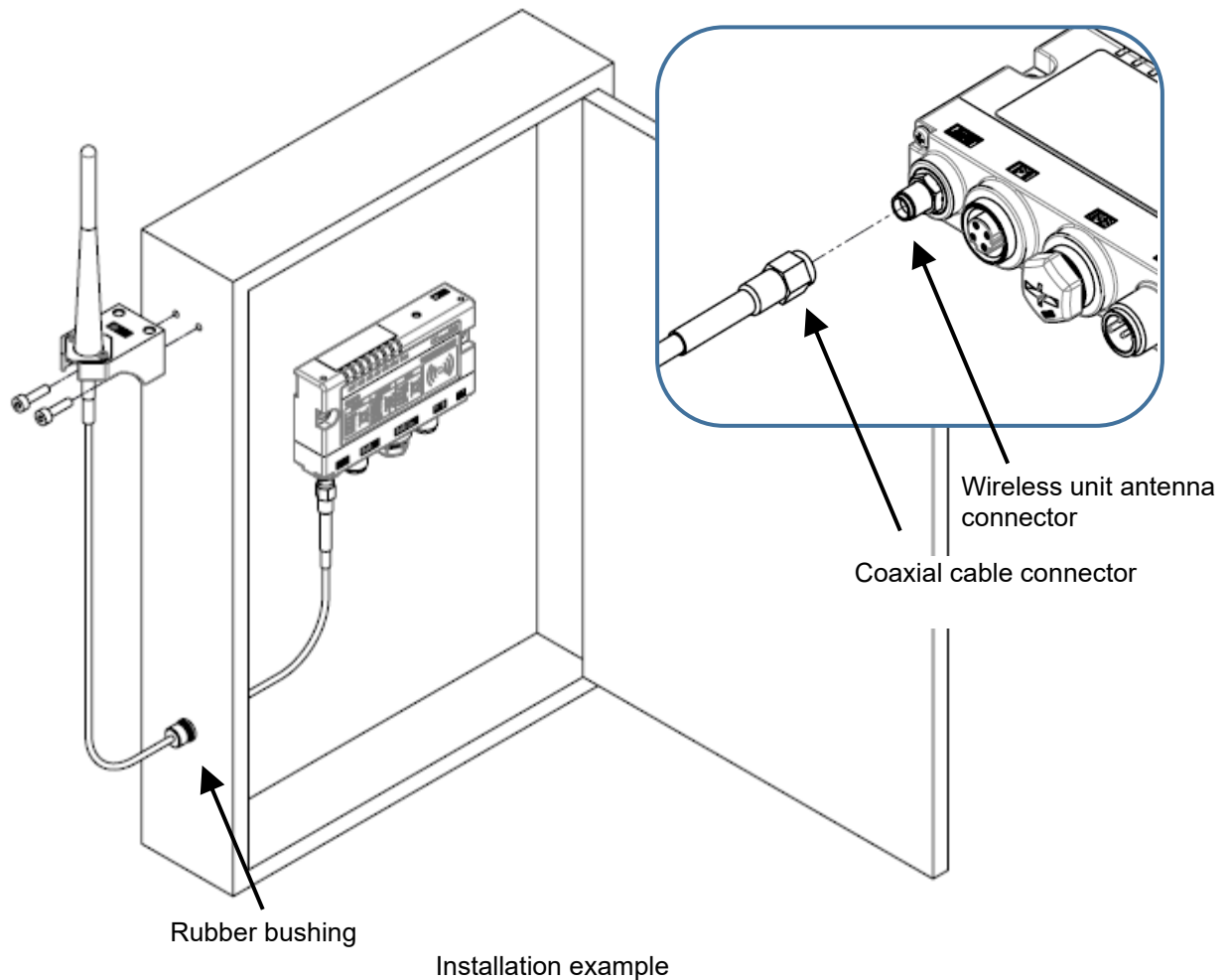

EtherCAT

Connect the "PORT1" communication connector to the upstream device (PC, PLC etc.) and connect the "PORT2" communication connector to the downstream device.

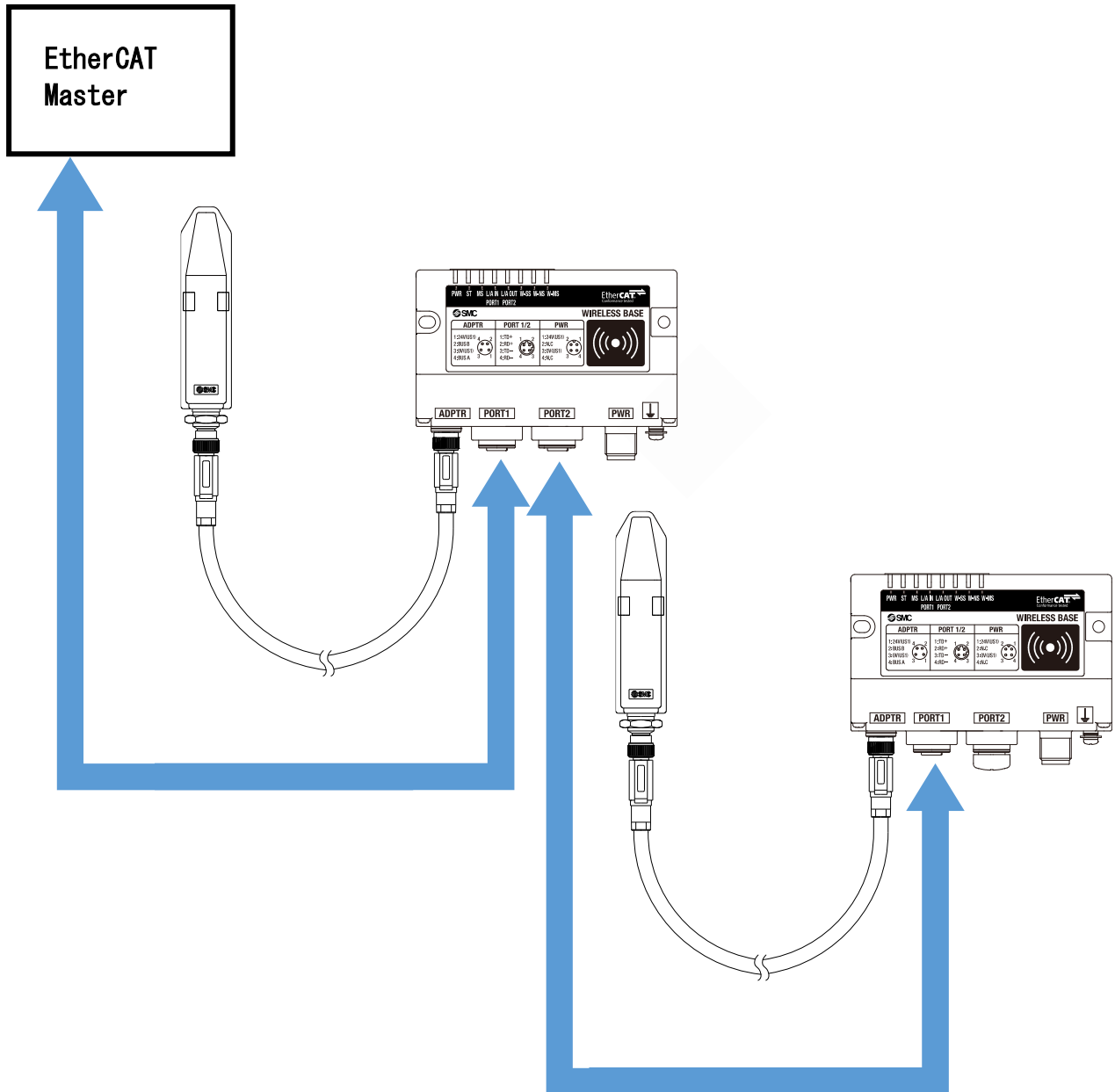

● Precautions for handling

Be sure to fit a seal cap on any unused connectors. Proper use of the seal cap enables the enclosure to achieve IP67 specification

Troubleshooting

When problems occur, take appropriate countermeasures while referring to the LED indication, troubleshooting and parameter settings.

If a cause applicable to the failure cannot be identified, this indicates that the equipment itself is broken. The fieldbus system damage can be caused by the operating environment. Contact SMC to obtain countermeasures.

•Base troubleshooting items

LED	Description	LED status		No.	
		Colour of LED	ON/Flashing		
-	All LEDs are OFF.	-	-	Problem 1	
PWR	PWR is OFF	-	OFF	Problem 2	
MS	MS LED does not turn on green.	Red	Flashing	Problem 3	
		Red	ON		
		-	OFF		
W-SS	W-SS LED flashes red or orange or is off.	Red	Flashing	Problem 4	
		Orange	Flashing		
		-	OFF		
W-NS	W-NS LED does not turn on green.	Green	Flashing	Problem 5	
		Red	Flashing		
		Red	ON		
		Red	Green		Alternate Flashing
		-	OFF		
W-MS	W-MS LED does not turn on green.	Red	Flashing	Problem 6	
		Red	ON		
		-	OFF		
L/A	L/A IN LED or L/A OUT LED is not flashing.	-	OFF	Problem 7	
		Green	ON		
ST	ST LED is red flasheing.	Red	Blinking	Problem 8	
			Single flashing		
			Double flashing		
Problems related to the NFC				Problem 9	

•Base troubleshooting

Problem No.	LED name	LED status		Possible causes	Investigation and countermeasures
		Colour of LED	ON/Flashing		
1	All	-	OFF	The US1 (for control) power supply is OFF	Supply 24 VDC +/-10% for US1 (for control) power source.
2	PWR	-	OFF	The US1 (for control) power supply is OFF	Supply 24 VDC +/-10% for US1 (for control) power source.
3	MS	Red	Flashing	The following diagnostic information is detected.	After checking the error contents while referring to the system diagnostic information and LED indication, refer to the following countermeasures.
				(1) US1 (for control) power supply voltage level is abnormal	(1) The US1 (for control) power voltage is low. Supply 24 VDC +/-10%.
				(2) Number of system input / output points setting error	(2) The number of wireless system inputs/outputs has exceeded the set value. Reduce the number of inputs/outputs mapped to the wireless system (Base and Remotes) to 11784 points /11784points (1473 byte/1473 byte) or less.
				(3) Number of registered Remotes error	(3) The number of registered Remotes has exceeded the set value. Change the Max. Remote units of the Base. Delete the registrations of the Remotes (wireless channels) outside of the set range or change the wireless channels to valid channels.
				(4) Memory read/write error	(4) Internal memory read/write operations are not performed normally. Initialize the product.
				(5) Wireless adaptor internal connection error	(5) Internal communication with the wireless adaptor is not performed normally. Check for loose connectors and broken wires.
		Red	ON	Base failure	Replace the Base. If the error persists after replacement, stop using the equipment and contact your SMC sales representative.
		-	OFF	Base turned OFF	Supply 24 VDC +/-10% for US1 (for control) power source.

Problem No.	LED name	LED status		Possible causes	Investigation and countermeasures
		Colour of LED	ON/Flashing		
4	W-SS	Red	Flashing	When Protocol V.1.0 is used (1) Remote power supply is OFF (2) Outside the wireless coverage area	(1) Supply 24 VDC +/-10% to the US1 (for control / input) power source of the Remote. (2) The distance which wireless communication between wireless systems can be established may have been exceeded. Reconsider the operating environment, such as the installation conditions, of the Base and Remote.
		Orange	Flashing	When Protocol V.2.0 is used (1) Remote power supply is OFF (2) Outside the wireless coverage area	(1) Supply 24 VDC +/-10% to the US1 (for control / input) power source of the Remote. (2) The distance which wireless communication between wireless systems can be established may have been exceeded. Reconsider the operating environment, such as the installation conditions, of the Base and Remote.
		-	OFF	Remote not registered	Check the registration status of the Remote and perform pairing correctly.
5	W-NS	Green	Flashing	(1) Some Remotes are not connected (2) Some registered Remotes have no wireless signal	(1) Supply 24 VDC +/-10% to the US1 (for control / input) power source of the Remote. (2) The distance which wireless communication between wireless systems can be established may have been exceeded. Reconsider the operating environment, such as the installation conditions, of the Base and Remote.
		Red	Flashing	(1) Power supply to all registered Remotes is OFF (2) All registered Remotes have no wireless signal	(1) Supply 24 VDC +/-10% to the US1 (for control / input) power source of the Remote. (2) The distance which wireless communication between wireless systems can be established may have been exceeded. Reconsider the operating environment, such as the installation conditions, of the Base and Remote.
		Red	ON	No Remotes are connected due to a failure of the Base	Replace the Base. If the error persists after replacement, stop using the equipment and contact your SMC sales representative.
		Red	Alternate Flashing	In pairing mode.	The system has been set to "Pairing enable". Change the setting to "Pairing disable" when pairing is not conducted.
		-	OFF	Remote not registered	Check the registration status of the wireless unit and conduct pairing with the Remote correctly.

Problem No.	LED name	LED status		Possible causes	Investigation and countermeasures
		Colour of LED	ON/Flashing		
6	W-MS	Red	Flashing	<p>The following Remote diagnostic information is detected.</p> <p>(1) US1 (for control) power supply voltage level is abnormal</p> <p>(2) US2 (for output) power supply voltage level is abnormal</p> <p>(3) Excessive I/O setting for inputs/outputs</p> <p>(4) Error in communication between units (4)-1 Abnormal input unit (4)-2 Abnormal output unit (4)-3 Abnormal input / output unit</p> <p>(5) EX600 I/O unit detects diagnostic information (5)-1 Short-circuited US1 (for control / input) power supply voltage (5)-2 Short-circuited US2 (for output) power supply voltage (5)-3 Short-circuited output load (5)-4 User set upper or lower limit of the analog unit exceeded (5)-5 I/O range upper or lower limit of the analog unit exceeded</p> <p>(6) Valve diagnostic information detected (6)-1 Valve short-circuited (6)-2 Valve with broken line</p>	<p>After checking the error contents while referring to the system diagnostic information and LED indication, refer to the following countermeasures.</p> <p>As this LED indicates the system status of the Remote, the following diagnoses can be conducted only when the "Diagnostic allocation" is set to "Advanced".</p> <p>(1) Supply 24 VDC +/-10% to the US1 (for control / input) power source of the Remote.</p> <p>(2) Supply 24 VDC +/-10% to the US2 (for output) power source of the Remote</p> <p>(3) The number of the station's input / output points has exceeded the set value. Check the occupied bytes of the EX600 I/O unit and valve manifold connected to the Remote.</p> <p>(4) Confirm that there is no loose connection between the units and connect them correctly.</p> <p>(5) Check the part where the error occurs by checking the LED indication and information of the system diagnostics, and refer to the operation manual for the digital and analog units.</p> <p>(6) Replace the valve and check the operation.</p>
	W-MS	Red	ON	Remote malfunction	Replace the Remote If the error persists after replacement, stop using the equipment and contact your SMC sales representative.

Problem No.	LED name	LED status		Possible causes	Investigation and countermeasures
		Colour of LED	ON/Flashing		
7	L/A IN or L/A OUT	-	OFF	LINK has not yet been established.	<p>Check the following and restart.</p> <p>(1) Check if the power is supplied to the EtherCAT device one level above.(When L/A port1 LED is OFF.)</p> <p>(2) Check that the connectors of L/A port1 and L/A port2 communication cables are connected and there are no broken wires.</p> <p>(3) Keep noise sources away from the communication cable.</p>
		Green	ON	LINK is established but data has not been received.	<p>Check the following and restart.</p> <p>(1) Check the master condition and run the master.</p> <p>(2) Check that the communication connector is not loose and there are no broken wires.</p> <p>(3) Keep noise sources away from the communication cable.</p>
8	ST	Red	Blinking	Invalid configuration.	Check the master configuration and the system structure.
			Single flashing	Sync error. Communication data error.	Check the master configuration and the system structure.
			Double flashing	Sync Manager watchdog timeout.	<p>Check the following and restart.</p> <p>(1) Check the master condition and run the master.</p> <p>(2) Check if the power is supplied to the EtherCAT device.</p> <p>(3) Check that the communication connector is not loose and there are no broken wires.</p>

Problem No.	Phenomenon	Possible causes	Investigation and countermeasures
9	NFC communication error	NFC communication is not established (communication failure)	<p>Check the following items and check the operation again.</p> <ul style="list-style-type: none"> •Confirm that the settings of the NFC port and PaSoRi of the PC are correct. •Check that the specifications of the NFC reader / writer to be used are appropriate. •Confirm that the NFC reader / writer are connected correctly. •The communication distance is outside of the NFC range. Place the body (NFC antenna approach area) close to the NFC reader / writer.
		NFC reader/writer broken	<p>Replace the NFC reader / writer and check the operation. If the error persists after replacement, stop using the equipment and contact your SMC sales representative.</p>

•Wireless Adaptor troubleshooting items

LED	Description	LED status		No.
		Colour of LED	ON/Flashing	
-	All LEDs are OFF.	-	-	Problem 1
PWR	PWR LED is red or flashes orange or is off.	-	OFF	Problem 2
		Orange	Flashing	
		Red	ON	
W-SS	W-SS LED flashes red or orange or is off.	Red	Flashing	Problem 3
		Orange	Flashing	
		-	OFF	

Wireless Adaptor troubleshooting

Problem No.	LED name	LED status		Possible causes	Investigation and countermeasures
		Colour of LED	ON/Flashing		
1	All	-	OFF	The US1 (for control) power supply is OFF.	Supply 24 VDC +/-10% to the US1 (for control / input) power source of the connected Base.
2	PWR	-	OFF	The US1 (for control) power supply is OFF.	Supply 24 VDC +/-10% to the US1 (for control / input) power source of the connected Base.
		Orange	Flashing	Internal communication error with the wireless adaptor.	Check for loose connectors and broken wires.
		Red	ON	Wireless Adaptor malfunction.	Replace the Wireless Adaptor. If the error persists after replacement, stop using the equipment and contact your SMC sales representative.
3	W-SS	Red	Flashing	When Protocol V.1.0 is used. (1) Power supply of registered Base or all Remotes are OFF. (2) Outside the wireless coverage area.	(1) Supply 24 VDC +/-10% to the US1 (for control / input) power source of the registered Base. (2) The distance which wireless communication between wireless systems can be established may have been exceeded. Reconsider the operating environment, such as the installation conditions, of the Base and Remote.
		Orange	Flashing	When Protocol V.2.0 is used. (1) Power supply of registered Base or all Remotes are OFF. (2) Outside the wireless coverage area.	(1) Supply 24 VDC +/-10% to the US1 (for control / input) power source of the registered Base. (2) The distance which wireless communication between wireless systems can be established may have been exceeded. Reconsider the operating environment, such as the installation conditions, of the Base and Remote.
		-	OFF	Not registered.	Check the registration status of the Base or Remotes and perform pairing correctly.

•Remote I/O unit troubleshooting items

LED	Description	LED status		No.	
		Colour of LED	ON/Flashing		
-	All LEDs are OFF.	-		Problem 1	
PWR	PWR LED does not turn on green.	Red	Flashing	Problem 2	
		-	OFF		
MS	MS LED does not turn on green.	Red	Flashing	Problem 3	
		Red	ON		
		-	OFF		
W-SS	Red W-SS LED flashes or is OFF.	Red	Flashing	Problem 4	
		Orange	Flashing		
		-	OFF		
W-NS	W-NS LED does not turn on green.	Red	Flashing	Trouble 5	
		Orange	Flashing (1 Hz)		
		Red	ON		
		Red	Green		Alternate Flashing
		-	OFF		
Digital input /output device does not operate correctly.				Problem 6	
Problems related to the NFC				Problem 7	

•Remote troubleshooting

Trouble No.	LED Name	LED status		Possible causes	Investigation and countermeasures
		Colour of LED	ON/Flashing		
1	All	-	OFF	The US1 (for control / input) power supply is OFF	Supply 24 VDC +/-10% for US1 (for control / input) power source.
2	PWR	Red	Flashing	Reduction in the US2 (for output) power voltage (when the setting is enabled)	The power supply voltage of the US2 (for output) power supply is low. Supply 24 VDC +/-10%.
		-	OFF	The US1 (for control / input) power supply is OFF	Supply 24 VDC +/-10% for US1 (for control / input) power source.
3	MS	Red	Flashing	The following diagnostic information is detected.	After checking the error contents while referring to the system diagnostic information and LED indication, refer to the following countermeasures.
				(1) Short-circuit detection of the US1 power supply (for control / input)	(1) Re-wire the short-circuited part or check if the cable and input device are normal.
				(2) US1 (for control / input) power supply voltage level is abnormal (when the setting is enabled)	(2) The power supply voltage of the US1 (for control / input) power supply is low. Supply 24 VDC +/-10%.
				(3) Short-circuit detection of the US2 power supply (for output)	(3) Re-wire the short-circuited part or check if the cable and output device are normal
		Red	ON	Remote malfunction	Replace the Remote If the error persists after replacement, stop using the equipment and contact your SMC sales representative.
		-	OFF	The US1 (for control / input) power supply is OFF	Supply 24 VDC +/-10% for US1 (for control / input) power source.

Problem No.	LED Name	LED status		Possible causes	Investigation and countermeasures
		Colour of LED	ON/Flashing		
4	W-SS	Red	Flashing	When Protocol V.1.0 is used (1) Power supply for the Base is OFF (2) Outside the wireless coverage area	(1) Supply 24 VDC +/-10% for the US1 (for control) power source of the Base. (2) The distance which wireless communication between wireless systems can be established may have been exceeded. Reconsider the operating environment, such as the installation conditions, of the Base and Remote.
		Orange	Flashing	When Protocol V.2.0 is used (1) Power supply for the Base is OFF (2) Outside the wireless coverage area	(1) Supply 24 VDC +/-10% for the US1 (for control) power source of the Base. (2) The distance which wireless communication between wireless systems can be established may have been exceeded. Reconsider the operating environment, such as the installation conditions, of the Base and Remote.
		-	OFF	(1) Remote not registered (2) The US1 (for control / input) power supply is OFF	(1) Check the registration status of the Remote and perform pairing correctly. (2) Supply 24 VDC +/-10% for US1 (for control / input) power source.

Problem No.	LED Name	LED status		Possible causes	Investigation and countermeasures	
		Colour of LED	ON/Flashing			
5	W-NS	Red	Flashing	(1) Power supply for the Base is OFF (2) Outside the wireless coverage area	(1) Supply 24 VDC +/-10% for the US1 (for control) power source of the Base. (2) The distance which wireless communication between wireless systems can be established may have been exceeded. Reconsider the operating environment, such as the installation conditions, of the Base and Remote.	
		Red	ON	Remote malfunction	Replace the Remote If the error persists after replacement, stop using the equipment and contact your SMC sales representative.	
		Red	Green	Alternate Flashing	In pairing mode.	The system has been set to "Pairing enable". Change the setting to "Pairing disable" when pairing is not conducted.
		Orange	Flashing (1 Hz)	Fn (pairing button) in use	Fn is being used. Change the mode according to the application.	
		-	OFF	(1) Base not registered (2) The US1 (for control / input) power supply is OFF	(1) Check the registration status of the Remote and perform pairing correctly. (2) Supply 24 VDC +/-10% for US1 (for control / input) power source.	

Problem No.	Phenomenon	Possible causes	Investigation and countermeasures
6	Abnormal digital input device operation	Input type does not match.	If the polarities (PNP, NPN) of the Remote and digital input unit do not match, replace one of them to make the combination match.
		US1 (for control / input) power voltage drop	Supply a voltage of 24 VDC +/-10% to the US1 (for control / input) power source of the Remote.
		Wiring or connection is defective.	Connect the wiring between the Remote and the digital input equipment correctly.
		Remote malfunction	Replace the Remote and check the operation.
		Digital input equipment broken	Replace the digital input equipment and check the operation. Or refer to Troubleshooting for the applicable digital input equipment.
	Abnormal digital output equipment operation	Mismatched output type	If the polarities (PNP, NPN) of the Remote and digital output unit do not match, replace one of them to make the combination match.
		US2 (for output) power voltage drop	Supply 24 VDC +/-10% to the US2 (for output) power source of the Remote.
		Wiring or connection is defective.	Connect the wiring between the Remote and the digital output equipment correctly.
		Remote malfunction	Replace the Remote and check the operation.
		Digital output equipment broken	Replace the digital output equipment and check the operation. Or refer to Troubleshooting for the applicable digital output equipment.
Program error	Check that the ladder logic program works correctly.		

Problem No.	Phenomenon	Possible causes	Investigation and countermeasures
7	NFC communication error	NFC communication is not established (communication failure)	<p>Check the following items and check the operation again.</p> <ul style="list-style-type: none"> •Confirm that the settings of the NFC port and PaSoRi of the PC are correct. •Check that the specifications of the NFC reader / writer to be used are appropriate. •Confirm that the NFC reader / writer are connected correctly. •The communication distance is outside of the NFC range. Place the body (NFC antenna approach area) close to the NFC reader / writer.
		NFC reader/writer broken	<p>Replace the NFC reader / writer and check the operation. If the error persists after replacement, stop using the equipment and contact your SMC sales representative.</p>

Technical Information

I/O Map

The table below shows the effective number of occupied bits for each input/output unit (including EX600 series) which can be connected to the Base and Remotes.

The allocated input/output sizes can be changed depending on the occupied bytes of the diagnostic mapping and the I/O unit connected to the wireless unit.

Refer to the table below for the number of input/output bits for each unit.

EXW1-series

Unit name	Diagnostic allocation	Max. Remote units	Allocated bytes	
			Input	Input
Compact wireless Base EXW1-BEAC	None	15/31/63	2	2
	Simple	15/31/63	6	2
	Advanced	15	12	2
		31	18	2
		63	30	2

EXW1-series

Unit name	Model	Unit product no.	Allocated bytes	
			Input	Output
Compact wireless Remote	RDX	EXW1-RDX*E4** (16 points)	2	0
	RDY	EXW1-RDY*E4** (16 points)	0	2
	RDM	EXW1-RDM*E4** (8 points)	2*1	2*1

*1: The number of inputs/outputs is fixed at 16 (16 bits), and only the lower 8 bits are valid.

EX600-W Series

Unit name	Model	Unit product no.	Allocated bytes	
			Input	Output
Wireless Remote	WSV	EX600-WSV* (32 points)	0	4
		EX600-WSV* (24 points)	0	3
		EX600-WSV* (16 points)	0	2
		EX600-WSV* (8 points)	0	1
		EX600-WSV* (0 points)	0	0
Digital input unit (EX600 Series)	DX	EX600-DX *B (8 points)	1	0
		EX600-DX *C (8 points)	1	0
		EX600-DX *C1 (8 points) (with broken line detection)	1	0
		EX600-DX *D (16 points)	2	0
		EX600-DX *E (16 points)	2	0
		EX600-DX *F (16 points)	2	0
Digital output unit (EX600 Series)	DY	EX600-DY *B (8 points)	0	1
		EX600-DY *E (16 points)	0	2
		EX600-DY *F (16 points)	0	2
Digital I/O unit (EX600 Series)	DM	EX600-DM *E (8/8 points)	1	1
		EX600-DM *F (8/8 points)	1	1
Analog input unit	AX	EX600-AXA*1 (2 points)	4 (2 bytes per channel)	0
Analog output unit	AY	EX600-AYA*1 (2 points)	0	4 (2 bytes per channel)
Analog I/O unit	AM	EX600-AMB*1 (2/2 points)	4 (2 bytes per channel)	4 (2 bytes per channel)

*1: User set minus ranges are not supported.

I/O Mapping

The I/O map is assigned in order of diagnostic information and remote. The remote allocation order to the I/O map is decided by the wireless channel at the remote registration. As they are allocated from the smallest registered channel number, the channel in which no remote is registered will be ignored. (Refer to the figure below.)

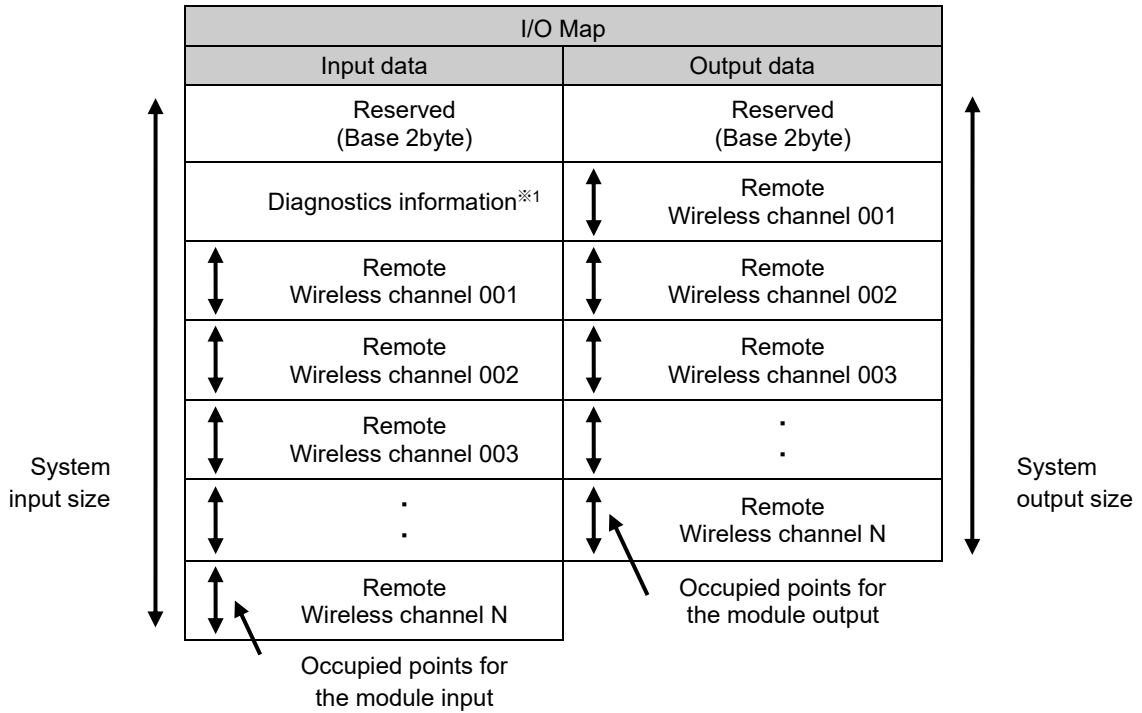

*1: This is selected according to the diagnostic allocation parameter setting of the base.
Refer to the section "Diagnostics Mapping" for details.

Diagnostics Mapping

The mapping of system diagnostic and Remote connection/diagnostic/registration information is as shown below.

Input Byte	Diagnostic allocation				
	None	Simple	Advanced		
			Max. Remote units		
			15 Remotes	31 Remotes	63 Remotes
0	Reserved (Base Input 0)				
1	Reserved (Base Input 1)				
2		System Diagnosis 1			
3		System Diagnosis 2			
4		System Diagnosis 3			
5		System Diagnosis 4			
6			Remote Connect Info 1-7	Remote Connect Info 1-7	Remote Connect Info 1-7
7			Remote Connect Info 8-15	Remote Connect Info 8-15	Remote Connect Info 8-15
8			Remote Diag Info 1-7	Remote Connect Info 16-23	Remote Connect Info 16-23
9			Remote Diag Info 8-15	Remote Connect Info 24-31	Remote Connect Info 24-31
10			Remote Reg Info 1-7	Remote Diag Info 1-7	Remote Connect Info 32-39
11			Remote Reg Info 8-15	Remote Diag Info 8-15	Remote Connect Info 40-47
12				Remote Diag Info 16-23	Remote Connect Info 48-55
13				Remote Diag Info 24-31	Remote Connect Info 56-63
14				Remote Reg Info 1-7	Remote Diag Info 1-7
15				Remote Reg Info 8-15	Remote Diag Info 8-15
16				Remote Reg Info 16-23	Remote Diag Info 16-23
17				Remote Reg Info 24-31	Remote Diag Info 24-31
18					Remote Diag Info 32-39
19					Remote Diag Info 40-47
20					Remote Diag Info 48-55
21					Remote Diag Info 56-63
22					Remote Reg Info 1-7
23					Remote Reg Info 8-15
24					Remote Reg Info 16-23
25					Remote Reg Info 24-31
26					Remote Reg Info 32-39
27					Remote Reg Info 40-47
28					Remote Reg Info 48-55
29					Remote Reg Info 56-63

I/O mapping order of Base/Remote

The I/O and diagnostic map is shown with the following unit configuration as an example.

•The compact wireless Base Diagnostic allocation: detail, Max. Remote units: 15

<Example>

	Unit 3	Unit 2	Unit 1	Unit 0	
	DY□B	AXA	DX□D	EX600-WSV*	
End plate	Digital output	Analog input	Digital input	Remote	Valve manifold
	1 byte output	4 bytes input	2 bytes input	4 bytes output	(32 points)

Remote setting parameters values
(Wireless channel 001)

Module input size: 64 points / 64 bits
Module output size: 48 points / 48 bits
Manifold output size: 32 points / 32 bits
I/O unit layout mode: Mode 2

Remote configuration (Wireless channel "001")

Input data: [Unit 1] Digital input unit (EX600-DX*D): 2 bytes occupied
[Unit 2] Analog input unit (EX600-AXA): 4 bytes occupied
Output data: [Unit 0] Remote (EX600-WSV*): 4 bytes occupied
[Unit 3] Digital output unit (EX600-DY*B): 1 byte occupied

	Unit 3	Unit 2	Unit 1	Unit 0	
	DY□B	DX□D	DX□B	EX600-WSV*	
End plate	Digital output	Digital input	Digital input	Remote	End plate
	1 byte output	2 bytes input	1 byte input	0 byte output	(Output side)

Remote setting parameters values
(Wireless channel 002)

Module input size: 32 points / 32 bits
Module output size: 16 points / 16 bits
Valve manifold output size: 0 points / 0 bits
I/O unit layout mode: Mode 2

Remote configuration (Wireless channel "002")

Input data: [Unit 1] Digital input unit (EX600-DX*B): 1 byte occupied
[Unit 2] Digital input unit (EX600-DX*D): 2 bytes occupied
Output data: [Unit 0] Remote (EX600-WSV*): 0 byte occupied
[Unit 3] Digital output unit (EX600-DY*B): 1 byte occupied

EXW1-RDM*	
Remote	
Digital input	Digital output
2 bytes	2 byte

Remote configuration (Wireless channel "003")

Input data: EXW1-RDM* 2 bytes occupied
Output data: EXW1-RDM* 2 bytes occupied

* The number of inputs/outputs of EXW1-RDM* is fixed at 16 (16 bits), and only the lower 8 bits are valid.

When EX600-WSV are paired, the mapping order of the EX600 I/O unit and the valve manifold connected to the Remote is different depending on the I/O unit layout mode in the Remote parameter setting. Refer to the operation manual of EX600-W Series for details on the I/O unit mapping order when an EX600-W Series unit is paired.

	Input data		Output data			
	Module name	Unit name	Module name	Unit name		
Byte0	Base	Reserved	Base	Reserved		
Byte1		Reserved		Reserved		
Byte2	System diagnosis 1		Remote Wireless channel "001"	EX600-WSV* (Unit 0) 32 valve outputs		
Byte3	System diagnosis 2					
Byte4	System diagnosis 3					
Byte5	System diagnosis 4					
Byte6	Remote connection information (Wireless channels 1-7; bit0 is fixed at "0".)					
Byte7	Remote connection information (Wireless channels 8-15)			DY*B (Unit 3)		
				Reserved		
Byte8	Remote diagnostic information *1 (Wireless channels 1-7)		Remote Wireless channel "002"	DY*B (Unit 3)		
Byte9	Remote diagnostic information (Wireless channels 8-15)			Reserved		
Byte10	Remote registration information (Wireless channels 1-7; bit0 is fixed at "0".)		Remote Wireless channel "003"	EXW1-RDM*		
Byte11	Remote registration information (Wireless channels 8-15)			Reserved		
Byte12	Remote Wireless channel "001"	DX*D (Unit 1)	/			
Byte13						
Byte14		AXA (Unit 2)				
Byte15						
Byte16						
Byte17						
byte18		Reserved				
byte19	Reserved					
byte20	Remote Wireless channel "002"	DX*B (Unit 1)				
byte21		DX*D (Unit 2)				
byte22						
byte23		Reserved				
byte24	Remote Wireless channel "003"	EXW1-RDM*				
byte25		Reserved				
Total	26 byte				12 byte	

Note) When "Diagnostic allocation" is set to "Advanced", a portion of the area is occupied for the number of Remotes specified using the number of registered Remote setting.

(The occupied area also occupies the area for Remotes which has not been registered.)

*1: The bit0 of Remote diagnostic information indicates the diagnostic information of the Base.

Diagnosics map details

When an error occurs in the Base or Remote, a flag will be set in a Bit corresponding to each item of diagnostic information.

The errors for the system diagnostics 1 to 4 are for the entire system. Therefore, even if there is only one unit which has an error in the constructed system, a flag will be set in a Bit corresponding to the error content.

It is possible to identify the abnormal Remote using the Remote diagnostic information.

(It is necessary to set the "Diagnostic allocation" to "Advanced".)

Regardless of the setting of the "Diagnostic allocation", the abnormal module and unit can be identified using the I/O Configurator provided by SMC.

Item	Byte	Bit No.	Content of diagnostics		Diagnosed area and processing upon error		How to reset	Reset conditions	Remarks (LED indications, etc.)
			Item	Details	Effective diagnostic coverage	I/O processing upon diagnosis			
System diagnosis 1	0	0	User setting lower level detection	Detected that the analog setting has exceeded the lower limit of the user set value.	Unit	Continue	Automatic reset	Select an appropriate range so that they are within the user set value range. Or disable the diagnostics.	Base W-MS: Flashes red ¹⁾ Remote MS: Flashes red
		1	User setting upper limit detection	Detected that the analog setting has exceeded the upper limit of the user set value.	Unit	Continue	Automatic reset	Select an appropriate range so that they are within the user set value range. Or disable the diagnostics.	
		2	Detection of the range lower limit	Detected that the analog setting has exceeded the lower limit of the setting range.	Unit	Continue	Automatic reset	Select an appropriate range so that the input value is within the set range.	
		3	Detection of the range upper limit	Detected that the analog setting has exceeded the upper limit of the setting range.	Unit	Continue	Automatic reset	Select an appropriate range so that the input value is within the set range.	
		4	Detection of upper limit of ON/OFF operation cycle	The number of ON/OFF operating cycles has exceeded the upper limit of the setting value.	Unit	Continue	Automatic reset	Reset the ON/OFF cycles to zero. Or disable the diagnostics.	
		5	Detection of unconnected load	Detects the broken wire.	Unit	Continue	Manual/automatic reset	(1) Replace the valve or the input/output equipment, and check the operation. (2) Replace the valve or the output equipment, and check the operation.	

Item	Byte	Bit No.	Content of diagnostics		Diagnosed area and processing upon error		How to reset	Reset conditions	Remarks (LED indications, etc.)
			Item	Details	Effective diagnostic coverage	I/O processing upon diagnosis			
System diagnosis 1	0	6	Short-circuit detection of output load	A short-circuit of the valve or the output equipment has been detected.	Unit	Continue	Manual/automatic reset	(1) Replace the valve or the output equipment, and check the operation. (2) Replace the valve or the output equipment, and check the operation.	W-MS: Flashes red*1 Remote MS: Flashes red
		7	Short-circuit detection of power supply for control / input	A short-circuit of the input equipment power supply has been detected.	Unit	Continue	Automatic reset	Check the part which has been causing the error and review the wiring or check if the input equipment is normal.	

Item	Byte	Bit No.	Content of diagnostics		Diagnosed area and processing upon error		How to reset	Reset conditions	Remarks (LED indications, etc.)
			Item	Details	Effective diagnostic coverage	I/O processing upon diagnosis			
System diagnosis 2		0	Detection of a reduction in the US2 (for output) power voltage	A voltage drop of the US2 (for output) power supply voltage has been detected.	Unit	Continue	Automatic reset	Supply 24 VDC +/-10% for the US2 (for output) power supply voltage.	Base W-MS: Flashes red Remote (EXW1) PWR: Flashes red Remote (EX600-W) PWR(V): Flashes red
		1	Detection of a reduction in the US1 (for control / input) power voltage	A voltage drop of the US1 (for control / input) power supply voltage has been detected.	Unit	Continue	Automatic reset	Supply 24 VDC +/-10% for the US1 (for control / input) power supply voltage.	Base MS: Flashes red or W-MS: Flashes red Remote MS: Flashes red
		2	Reserved	-	-	-	-	-	-
		3	Connection failure between units (during operation)	An error has occurred in the communication between the wireless unit and EX600 I/O units.	Unit	Stop (HOLD)	Turn the power on again.	Confirm that there is no loose connection between the EX600 I/O units, and connect them correctly.	Base W-MS: Flashes red Remote (EX600-W) MS: Flashes red
		4	Connection failure between units (when power is supplied)	An error has occurred in the communication between the wireless unit and EX600 I/O units.	Unit	Stop (HOLD)	Turn the power on again.	Confirm that there is no loose connection between the EX600 I/O units, and connect them correctly.	Base W-MS: Flashes red Remote (EX600-W) MS: Flashes red
		5	Reserved	-	-	-	-	-	-
		6	Detection of system error (when power is supplied)	An unrecoverable error has occurred in the system.	Unit	Stop (HOLD)	Manual reset	Supply power again. If the error persists after resupplying power, contact your SMC sales representative.	Base MS: Lights up red Remote MS: Lights up red
		7	Detection of hardware error (during operation)	An unrecoverable error has occurred in the hardware.	Unit	Stop (HOLD)	Manual reset	Supply power again. If the error is not restored after resupplying power, contact your SMC sales representative.	Base MS: Lights up red or W-MS: Lights up red Remote MS: Lights up red

Item	Byte	Bit No.	Content of diagnostics		Diagnosed area and processing upon error		How to reset	Reset conditions	Remarks (LED indications, etc.)
			Item	Details	Effective diagnostic coverage	I/O processing upon diagnosis			
System diagnosis 3	2	0	Number of inputs/outputs setting error	The number of occupied inputs/outputs of the Remote has exceeded the set value.	System	Continue	Manual reset	Change the user set value. Or, adjust the unit configuration so that the number of occupied points is within the set value.	Base W-MS: Flashes red Remote MS: Flashes red
		1	Reserved	-	-	-	-	-	-
		2	Reserved	-	-	-	-	-	-
		3	Wireless adaptor internal connection error	Internal communication with the wireless adaptor is not performed normally.	System	Continue	Automatic reset	Check for loose connectors and broken wires.	Base MS: Flashes red or Wireless adaptor PWR: Flashes orange
		4	Reserved	-	-	-	-	-	-
		5	Reserved	-	-	-	-	-	-
		6	System Error detected	Memory read/write error	System	Continue	Manual reset	Initialize the product. If the error persists after resupplying power, contact your SMC sales representative.	Base, Remote MS: Flashes red
		7	Detection of hardware error	Memory write error	System	Continue	Manual reset	Initialize the product. If the error persists after resupplying power, contact your SMC sales representative.	Base, Remote MS: Flashes red

Item	Byte	Bit No.	Content of diagnostics		Diagnosed area and processing upon error		How to reset	Reset conditions	Remarks (LED indications, etc.)
			Item	Details	Effective diagnostic coverage	I/O processing upon diagnosis			
System diagnosis 4	3	0	Number of system inputs/outputs setting error	The number of occupied system inputs/outputs has exceeded the set value.	System	Continue	Manual reset	Change the user set value. Or, adjust the unit configuration so that the number of occupied points is within the set value.	Base MS: Flashes red
		1	Number of registered Remotes setting error (Outside of the wireless channel setting range)	More wireless channels than specified in the number of registered Remotes setting are registered.	System	Continue	Manual reset	Change the set value of the number of registered Remotes. Or, delete the registered Remotes (wireless channels) outside of the set range.	Base MS: Flashes red
		2	Enforce mode	Active the enforce mode	System	Continue	Manual reset	Exit from enforce mode.	Base, Remote W-NS: Lights up orange
		3	Reserved	-	-	-	-	-	-
		4	Reserved	-	-	-	-	-	-
		5	Reserved	-	-	-	-	-	-
		6	Wireless registration data corrupted	An error has occurred in the wireless registration information.	System	Stop (HOLD)	Manual reset	Supply power again. If the error persists after resupplying power, contact your SMC sales representative.	Base MS: Lights up red or W-NS: Lights up red
		7	Detection of wireless hardware error	An unrecoverable error has occurred in the hardware of the wireless units.	System	Stop (HOLD)	Manual reset	Supply power again. If the error persists after resupplying power, contact your SMC sales representative.	Base MS: Lights up red or W-NS: Lights up red

Item	Byte	Bit No.	Content of diagnostics		Diagnosed area and processing upon error		How to reset	Reset conditions	Remarks (LED indications, etc.)
			Item	Details	Effective diagnostic coverage	I/O processing upon diagnosis			
Remote connection information Wireless channels 1-7 (Bit 0 is fixed at "0".)	4	0	-		-	-	-	-	When the connection data is "0", the wireless communication with the Remote is not connected.
		1	Connection condition of the Remote communication (Wireless channel 1)		-	-	-	-	
		2	Connection condition of the Remote communication (Wireless channel 2)		-	-	-	-	
		3	Connection condition of the Remote communication (Wireless channel 3)		-	-	-	-	
		4	Connection condition of the Remote communication (Wireless channel 4)		-	-	-	-	
		5	Connection condition of the Remote communication (Wireless channel 5)		-	-	-	-	
		6	Connection condition of the Remote communication (Wireless channel 6)		-	-	-	-	
		7	Connection condition of the Remote communication (Wireless channel 7)		-	-	-	-	
Remote connection information Wireless channels 8-15	5	0	Connection condition of the Remote communication (Wireless channel 8)		-	-	-	-	When the connection data is "1", the wireless communication with the Remote is connected normally.
		1	Connection condition of the Remote communication (Wireless channel 9)		-	-	-	-	
		2	Connection condition of the Remote communication (Wireless channel 10)		-	-	-	-	
		3	Connection condition of the Remote communication (Wireless channel 11)		-	-	-	-	
		4	Connection condition of the Remote communication (Wireless channel 12)		-	-	-	-	
		5	Connection condition of the Remote communication (Wireless channel 13)		-	-	-	-	
		6	Connection condition of the Remote communication (Wireless channel 14)		-	-	-	-	
		7	Connection condition of the Remote communication (Wireless channel 15)		-	-	-	-	

Item	Resister area	Bit No.	Content of diagnostics		Diagnosed area and processing upon error		How to reset	Reset conditions	Remarks (LED indications, etc.)
			Item	Details	Effective diagnostic coverage	I/O processing upon diagnosis			
Remote diagnostic information Wireless channels 1-7 (Bit 0 is for Base)	6	0	Presence / absence of system information error of Base		-	-	-	-	No error in the Base / Remote when the diagnostic data is "0". Error in the Base / Remote when the diagnostic data is "1".
		1	Presence / absence of system information error of Remote (Wireless channel 1)		-	-	-	-	
		2	Presence / absence of system information error of Remote (Wireless channel 2)		-	-	-	-	
		3	Presence / absence of system information error of Remote (Wireless channel 3)		-	-	-	-	
		4	Presence / absence of system information error of Remote (Wireless channel 4)		-	-	-	-	
		5	Presence / absence of system information error of Remote (Wireless channel 5)		-	-	-	-	
		6	Presence / absence of system information error of Remote (Wireless channel 6)		-	-	-	-	
		7	Presence / absence of system information error of Remote (Wireless channel 7)		-	-	-	-	
Remote diagnostic information Wireless channels 8-15	7	0	Presence / absence of system information error of Remote (Wireless channel 8)		-	-	-	-	
		1	Presence / absence of system information error of Remote (Wireless channel 9)		-	-	-	-	
		2	Presence / absence of system information error of Remote (Wireless channel 10)		-	-	-	-	
		3	Presence / absence of system information error of Remote (Wireless channel 11)		-	-	-	-	
		4	Presence / absence of system information error of Remote (Wireless channel 12)		-	-	-	-	
		5	Presence / absence of system information error of Remote (Wireless channel 13)		-	-	-	-	
		6	Presence / absence of system information error of Remote (Wireless channel 14)		-	-	-	-	
		7	Presence / absence of system information error of Remote (Wireless channel 15)		-	-	-	-	

Item	Byte	Bit No.	Content of diagnostics		Diagnosed area and processing upon error		How to reset	Reset conditions	Remarks (LED indications, etc.)
			Item	Details	Effective diagnostic coverage	I/O processing upon diagnosis			
Remote registration information Wireless channels 1-7 (Bit 0 is fixed at "0".)	8	0	-		-	-	-	-	When the registration data is "0", no Remote has been registered.
		1	Registration of Remote (Wireless channel 1)		-	-	-	-	
		2	Registration of Remote (Wireless channel 2)		-	-	-	-	
		3	Registration of Remote (Wireless channel 3)		-	-	-	-	
		4	Registration of Remote (Wireless channel 4)		-	-	-	-	
		5	Registration of Remote (Wireless channel 5)		-	-	-	-	
		6	Registration of Remote (Wireless channel 6)		-	-	-	-	
		7	Registration of Remote (Wireless channel 7)		-	-	-	-	
Remote registration information Wireless channels 8-15	9	0	Registration of Remote (Wireless channel 8)		-	-	-	-	When the registration data is "1", a Remote has been registered.
		1	Registration of Remote (Wireless channel 9)		-	-	-	-	
		2	Registration of Remote (Wireless channel 10)		-	-	-	-	
		3	Registration of Remote (Wireless channel 11)		-	-	-	-	
		4	Registration of Remote (Wireless channel 12)		-	-	-	-	
		5	Registration of Remote (Wireless channel 13)		-	-	-	-	
		6	Registration of Remote (Wireless channel 14)		-	-	-	-	
		7	Registration of Remote (Wireless channel 15)		-	-	-	-	

*1: The LED indicator W-MS indicates the system status of the Remote.

If it is ON or flashes, errors have occurred in the registered Remote.

*: When the diagnostic data of the system diagnostics 1-4 is "0", no error has occurred. When it is "1", errors have occurred.

*: This table is for when the number of registered Remotes is set to 15 in the Base settings.

The diagnostic sizes of Remote connection information, diagnostic information and registration information vary depending on the setting for the number of registered wireless units.

*: The bit0 of connection/registration information is fixed at "0".

*: The bit0 of diagnostic information indicates the diagnostic information of the Base.

ESI file

The ESI file is required to configure the EXW1.
The file can be downloaded from the SMC website.
URL : <https://www.smcworld.com/>

ESI file: SMC EXW1-BEC_V##.xm
*## : Version number.

■ Example of setting using TwinCAT3 XAE

This product supports only online configuration. Refer to the manual of TwinCAT3 XAE for details of the operating method.

1. ESI file installation
Copy the ESI file for the EXW1 to the following folder.
<TwinCAT® Installation Folder>:\TwinCAT\3.1\Config\Io\EtherCAT
Ex: "C:\TwinCAT\3.1\Config\Io\EtherCAT"
2. Right click the [Devices] file, and then left click the [Scan].

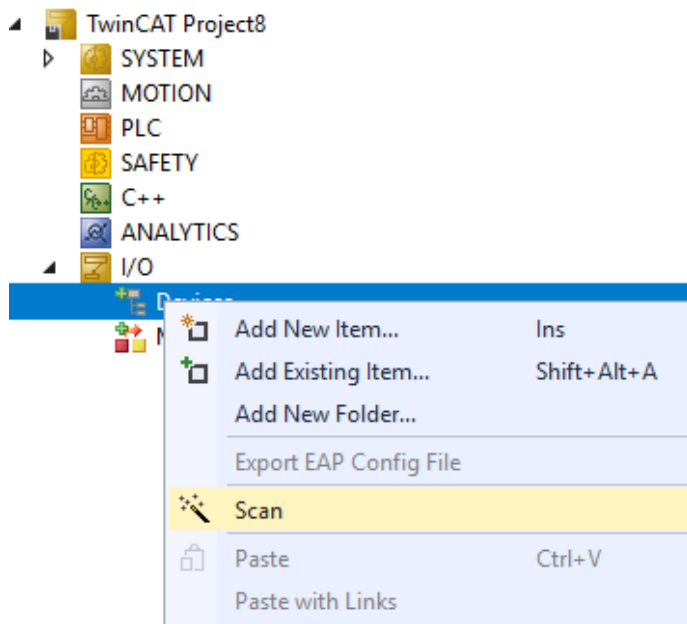

3. Click OK in the screen below.

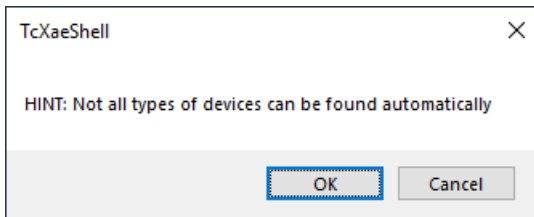

4. Select the checkbox and click OK in the screen below.

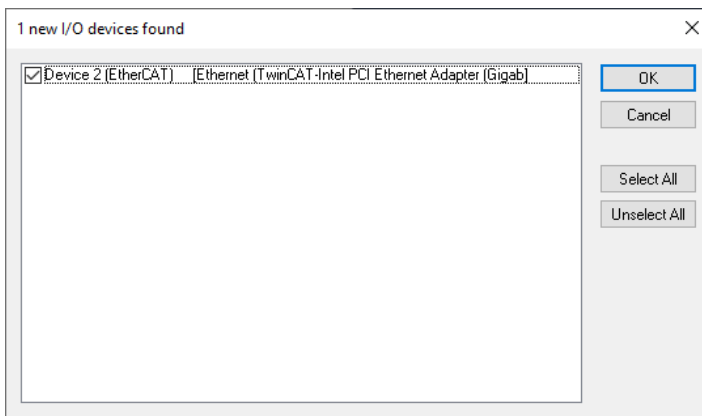

5. When the comment "Scan for boxes" appears, left click the [YES(Y)] button.

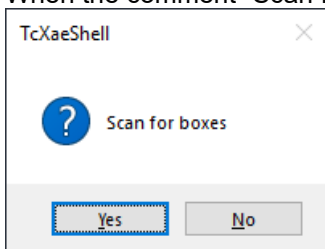

6. Once the scan is successfully completed, [Box 1 (EXW1-BEC)] is displayed as shown in the screen below.

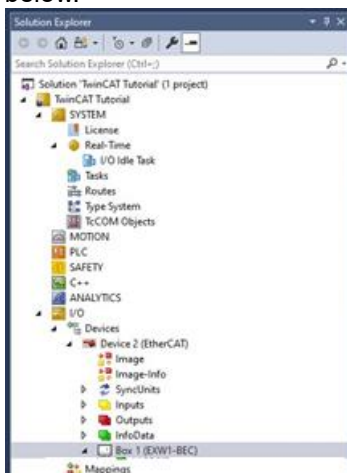

CoE Object

You can use the CoE Object Dictionary to check diagnostic data and read and write various parameters. The data format is as follows.

■ How to display CoE object

After selecting [Box1(EXW1-BEC)], select the [CoE-Online] tab to display the CoE object.

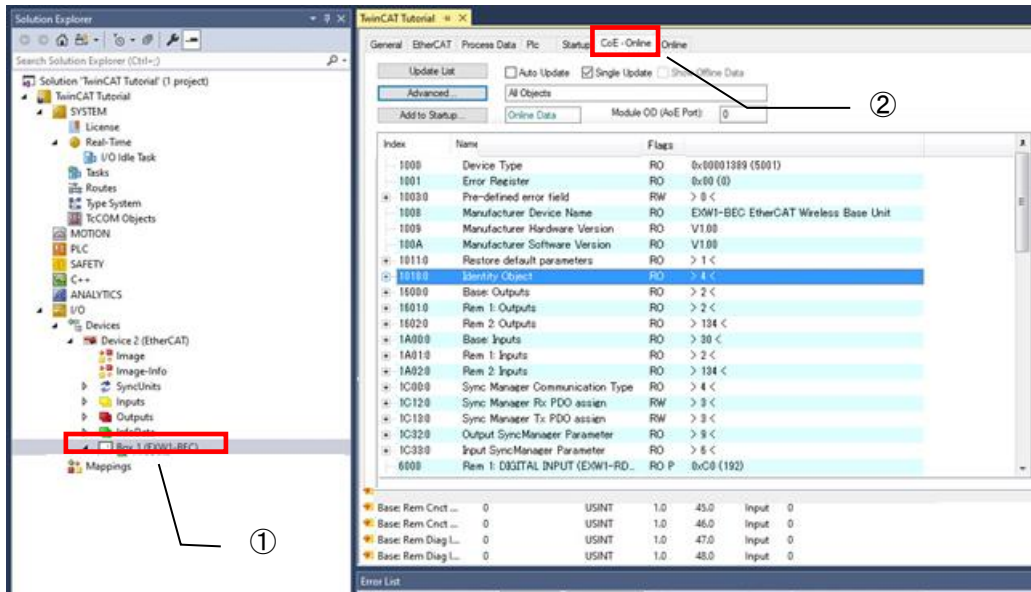

• Supported object

Index	Name	Fixed value
0x1000	Device type	0x00001389(5001dec)
0x1008	Device name	EXW1-BEC EtherCAT Wireless Base Unit
0x1009	Hardware version	V1.00
0x100A	Software version	V1.00
0x1018:0	Identity	0x04(4dec)
0x1018:01	Vendor ID	0x00000114(276dec)
0x1018:02	Product code	0x01000047 (16777287dec)
0x1018:03	Revision	0x00010000 (65536dec)
0x1018:04	Serial Number	0x#####
0x6000 - 0x63E9	Input PDOs	Input PDOs for the remotes
0x7000 - 0x73E9	Output PDOs	Output PDOs for the remotes
0x8000 – 0x83E9	Parameter Settings ^{*1}	Parameter setting data for the remotes
0x9000 – 0x93E0	Module Identification	Detected Module Ident List
0xA000 – 0xA3E9	Diagnostics ^{*1}	Diagnostics
0xF000 – 0xF800	Device Area	Parameter setting data for the EXW1-BEC

*1: Only available in Protocol V.2.0

■ Modular device profile

The wireless network is represented as a modular device in the CoE table.

CoE objects for remotes:

The slot / subslot system is emulated using the following logic:

Index 0xTMMN where:

T -> Topic:

6, 7, 8, 9, A for inputs, outputs, parameters, module info and diagnostics respectively

M -> Module index

0x00-0x3E, usually wireless channel - 1

N -> Submodule index

Remotes are made up of functions

Example:

EXW1-RDM Remote on Wireless Channel 2

Smod #	Unit Name	Input PDOs	Output PDOs	Parameters ^{*2}	Diagnostics
0	Digital Input	0x6010	-----	0x8010	0xA010
1	Digital Output	-----	0x7011	0x8011	0xA011
2	Remote	0x6012 (Padding ^{*1})	0x7012 (Padding ^{*1})	0x8012	-----

^{*1} Padding is automatically added when a remote has odd number of bytes as cyclic process data.

^{*2} Only available in Protocol V.2.0

■ EXW1-BECAC

Parameter settings:

Index	Name	Type	Default Value
0xF800:00	Base: Params	USINT	4
0xF800:01	Unit: Brown-out Detection for US1	ENUM0FFF	Enable
0xF800:02	Unit: Output State Fieldbus FaultIdle	ENUM0FFC	Clear
0xF800:03	Unit: Input State for RF Timeout	ENUM0FF7	Clear

Diagnostics:

Object 0xF110. See DETAILED cyclic diagnostics for the contents of this object.

Description for the parameters:

No.	Parameter	Definition	Item	Content	Default setting	Parameter setting range
1	Unit: Brown-out Detection for US1	Generated error when power supply voltage goes under approx. 19 V.	Enable	Generates an error.	○	Unit
			Disable	Does not generate an error.		
2	Unit: Output State Fieldbus FaultIdle	Output while upper communication is not established	Clear	Clear the output.	○	Unit
			Hold	Fix the output at the current value.		
			Individual	The set value of each wireless Remote is valid (not the entire system) .		
3	Unit: Input State for RF Timeout	Input information while wireless communication is not established	Clear	Clear the input.	○	Unit
			Hold	Fix the input at the current value.		

■ EXW1-RDX*

Parameter settings:

Index	Name	Type	Default Value
0x8MM1:00	Rem #: Params	USINT	1
0x8MM1:01	Unit: Brown-out Detection for US1	ENUM0FFF	Enable
Digital Input			
0x8MM0:00	Rem #: Params	USINT	24
0x8MM0:01	Unit: Short Circuit Detection (Power)	ENUM0FFF	Enable
0x8MM0:02	Unit: Inrush Current Filter	ENUM0FFF	Enable
0x8MM0:03	Unit: Input Filtering Time	ENUM0FFE	1
0x8MM0:04	Unit: Input Hold Time	ENUM0FFD	15
0x8MM0:05 ^{*1}	Ch 7-0: Open Circuit Detection	USINT	0(Disable)
0x8MM0:06 ^{*1}	Ch 15-8: Open Circuit Detection	USINT	0(Disable)
0x8MM0:07	Ch 7-0: ON/OFF Counter Limit Detection	USINT	0(Disable)
0x8MM0:08	Ch 15-8: ON/OFF Counter Limit Detection	USINT	0(Disable)
0x8MM0:09 ^{*2} -0x8MM0:18 ^{*2}	Ch #: Counter Limit Value (1k-65000k)	UINT	65000

^{*1} Even though this parameter is represented, not supported.

^{*2} One of these parameters are generated for every channels

Description for the parameters:

No.	Name	Definition	Item	Default setting	Content	Parameter setting range
1	Unit: Brown-out Detection for US1	Generated error when power supply voltage goes under approx. 19 V.	Enable	○	Generates an error.	Unit
			Disable		Does not generate an error.	
2	Unit: Short Circuit Detection (Power)	Generates error when the short circuit of the power supply for the input device is detected.	Enable	○	Generates an error.	Unit
			Disable		Does not generate an error.	
3	Ch 7-0: Open Circuit Detection*1	<Reserved>	1 : Enable		1: Generates an error. 0; Does not generate an error.	Channel
			0 : Disable	○		
4	Ch 15-8: Open Circuit Detection*1	<Reserved>	1 : Enable		1: Generates an error. 0; Does not generate an error.	Channel
			0 : Disable	○		
5	Unit: Inrush Current Filter	Selects the over current detection for 100 msec after supplying power.	Enable		Ignores inrush current.	Unit
			Disable	○	Does not ignore inrush current.	
6	Unit: Input Filtering Time	Sets the time to ignore the input signal change.	0.1 ms	1.0 ms	Selects the time for filtering.	Unit
			1.0 ms			
			10 ms			
			20 ms			
7	Unit: Input Hold Time	Sets the time to hold the input signal.	1.0 ms	15 ms	Selects the time to hold the input signal.	Unit
			15 ms			
			100 ms			
			200 ms			
8	Ch 7-0: ON/OFF Counter Limit Detection	Generates error when the operation count exceeds the set value	Enable		1: Generates an error. 0; Does not generate an error. Bit0 : Channel 0 : Bit7 : Channel 7	Channel
			Disable	○		
9	Ch 15-8: ON/OFF Counter Limit Detection	Generates error when the operation count exceeds the set value	Enable		1: Generates an error. 0; Does not generate an error. Bit0 : Channel 8 : Bit7 : Channel 15	Channel
			Disable	○		

No.	Name	Definition	Item	Default setting	Content	Parameter setting range
10	Ch #: Counter Limit Value (1k-65000k)	Counter Limit Value *2	1~65000	-	Times for setting is set value x1000 times	-

*1: Even though this parameter is represented, not supported.

*2: The count is stored once every hour or when the power supply drops below approx. 19 V. When the power supply is restored, counting starts from the last value stored.

Diagnostics:

Index	Name	Type	Default Value
Digital Input			
0xAMM0:00	Rem.#: Diags	USINT	38
0xAMM0:01 * ¹ -0xAMM0:10 * ¹	Ch #:ON/OFF Counter Value	UDINT	0
0xAMM0:11 * ¹ -0xAMM0:20 * ¹	Ch #:ON/OFF Counter Clear	USINT	0
0xAMM0:21	Ch 7-0:Exceeded ON/OFF Counter Limit	USINT	0
0xAMM0:22	Ch 15-8:Exceeded ON/OFF Counter Limit	USINT	0
0xAMM0:23 * ²	Ch 7-0:Open Circuit Detection	USINT	0
0xAMM0:24 * ²	Ch 15-8:Open Circuit Detection	USINT	0
0xAMM0:25	Ch 7-0:Short Circuit Detection(Input)	USINT	0
0xAMM0:26	Ch 15-8: Short Circuit Detection(Input)	USINT	0

^{MM} Wireless channel – 1

*¹ One of these parameters are generated for every channels

*² Even though this parameter is represented, not supported.

• Diagnostics details

No.	Name	Definition	Type	Value
1	Ch #: ON/OFF Counter Value	ON/OFF count upper limit value *1	UDINT	0 – 4294967295 (0 to 0xFFFFFFFF)
2	Ch #: ON/OFF Counter Clear	Clears the Input ON/OFF counter to 0.	USINT	Set to 0
3	Ch 7-0: Exceeded ON/OFF Counter Limit	ON/OFF count of the valve has exceeded the set value. Channel diagnosis Ch0 to Ch7	BYTE	0: No error 1: Error Bit0: There is an error in channel 0. : Bit7: There is an error in channel 7.
4	Ch 15-8: Exceeded ON/OFF Counter Limit	ON/OFF count of the valve has exceeded the set value. Channel diagnosis Ch8 to Ch15	BYTE	0: No error 1: Error Bit0: There is an error in channel 8. : Bit7: There is an error in channel 15.
5	Ch 7-0: Open Circuit Detection*2	<Reserved>	BYTE	0 : No error (Fixed)
6	Ch 15-8: Open Circuit Detection*2	< Reserved>	BYTE	0 : No error (Fixed)
7	Ch 7-0: Short Circuit Detection (Input)	The short circuit of the power supply for the input device has been detected. Channel diagnosis Ch0 to Ch7	BYTE	0: No error 1: Error Bit0: There is an error in channel 0. : Bit7: There is an error in channel 7.
8	Ch 15-8: Short Circuit Detection (Input)	The short circuit of the power supply for the input device has been detected. Channel diagnosis Ch8 to Ch15	BYTE	0: No error 1: Error Bit0: There is an error in channel 8. : Bit7: There is an error in channel 15.

*1: The count is stored once every hour or when the power supply drops below approx. 19 V. When the power supply is restored, counting starts from the last value stored.

*2: Even though this parameter is represented, not supported.

■ EXW1-RDY*

Parameter settings:

Index	Name	Type	Default Value
0x8MM1:00	Rem.#: Params	USINT	4
0x8MM1:01	Unit: Brown-out Detection for US1	ENUM0FFF	Enable
0x8MM1:02	Unit: Brown-out Detection for US2	ENUM0FFF	Disable
0x8MM1:03	Unit: Output State Fieldbus FaultIdle	ENUM0FFC	Clear
0x8MM1:04	Unit: Output State for RF Timeout	ENUM0FFC	Hold
Digital Output			
0x8MM0:00	Rem.#: Params	USINT	34
0x8MM0:01	Unit: Short Circuit Detection(Output)	ENUM0FFF	Enable
0x8MM0:02	Unit: Restart After Short Circuit	ENUM0FFF	Enable
0x8MM0:03	Ch 7-0:Hold State for Fieldbus Fault	USINT	255
0x8MM0:04	Ch 15-8:Hold State for Fieldbus Fault	USINT	255
0x8MM0:05	Ch 7-0:Output State for Fieldbus Fault	USINT	0(Clear)
0x8MM0:06	Ch 15-8:Output State for Fieldbus Fault	USINT	0(Clear)
0x8MM0:07	Ch 7-0:Hold State for Fieldbus Idle	USINT	255
0x8MM0:08	Ch 15-8:Hold State for Fieldbus Idle	USINT	255
0x8MM0:09	Ch 7-0:Output State for Fieldbus Idle	USINT	0(Clear)
0x8MM0:0A	Ch 15-8:Output State for Fieldbus Idle	USINT	0(Clear)
0x8MM0:0B	Ch 7-0:Hold State for RF Timeout	USINT	0(Clear)
0x8MM0:0C	Ch 15-8:Hold State for RF Timeout	USINT	255
0x8MM0:0D	Ch 7-0:Output State for RF Timeout	USINT	0(Clear)
0x8MM0:0E	Ch 15-8:Output State for RF Timeout	USINT	0(Clear)
0x8MM0:0F	Ch 7-0:Open Circuit Detection	USINT	0(Disable)
0x8MM0:10	Ch 15-8:Open Circuit Detection	USINT	0(Disable)
0x8MM0:11	Ch 7-0:ON/OFF Counter Limit Detection	USINT	0(Disable)
0x8MM0:12	Ch 15-8:ON/OFF Counter Limit Detection	USINT	0(Disable)
0x8MM0:13 ^{*1} -0x8MM0:22 ^{*1}	Ch #:Counter Limit Value(1k-65000k)	UINT	65000

^{MM} Wireless channel – 1

^{*1} One of these parameters are generated for every channels

Description for the parameters:

No.	Name	Definition	Item	Default setting	Content	Parameter setting range
1	Unit: Brown-out Detection for US1	Generated error when power supply voltage (US1) goes under approx. 19 V.	Enable	○	Generates an error.	Unit
			Disable		Does not generate an error.	
2	Unit: Brown-out Detection for US2	Generated error when power supply voltage (US2) goes under approx. 19 V.	Enable	○	Generates an error.	Unit
			Disable		Does not generate an error.	
3	Unit: Output State Fieldbus Fault/Idle ^{*2}	Sets output status when Fieldbus Communication Fault/Idle is occurred.	Clear		Clear the output.	Unit
			Hold	○	Fix the output at the current value.	
			Individual		The set value of each channel parameter is valid.	
4	Unit: Output State for RF Timeout	Sets output status when Wireless Communication Timeout is occurred.	Clear	○	Clear the output.	Unit
			Hold		Fix the output at the current value.	
			Individual		The set value of each channel parameter is valid.	
5	Unit: Short Circuit Detection (Output)	Generates error when the short circuit of the output device is detected.*1	Enable	○	Generates an error.	Unit
			Disable		Does not generate an error.	
6	Unit: Restart After Short Circuit	Restore the setting of short circuit detection error after the output device short circuit is cleared.	Auto	○	Error is automatically cleared when the short circuit is fixed.	Unit
			Manual		Even when the short circuit is fixed, error is not cleared until the power is supplied again.	
7	Ch 7-0: Open Circuit Detection	Generates error when the disconnection of the output device is detected.	1 : Enable	○	1: Generates an error. 0; Does not generate an error. Bit0 : Channel 0 : Bit7 : Channel 7	Channel
			0 : Disable			
8	Ch 15-8: Open Circuit Detection	Generates error when the disconnection of the output device is detected.	1 : Enable	○	1: Generates an error. 0; Does not generate an error. Bit0 : Channel 8 : Bit7 : Channel 15	Channel
			0 : Disable			

No.	Name	Definition	Item	Default setting	Content	Parameter setting range
9	Ch 7-0: Hold State for Fieldbus Fault*2*3	Sets hold status when Fieldbus Communication error is occurred.	0:Hold	○	0: Hold the output 1: Depend on output state Bit0 : Channel 0 : Bit7 : Channel 7	Channel
			1:Depend on Output state Digital Value			
10	Ch 15-8: Hold State for Fieldbus Fault*2*3		0:Hold	○	0: Hold the output 1: Depend on output state Bit0 : Channel 8 : Bit7 : Channel 15	Channel
			1:Depend on Output state Digital Value			
11	Ch 7-0: Output state for Fieldbus Fault*2*3*4	Sets output status when Fieldbus Communication error is occurred.	Clear	○	0: Turn off the output 1: Turn on the output forcefully Bit0 : Channel 0 : Bit7 : Channel 7	Channel
			ForceON			
12	Ch 15-8: Output state for Fieldbus Fault*2*3*5		Clear	○	0: Turn off the output 1: Turn on the output forcefully Bit0 : Channel 8 : Bit7 : Channel 15	Channel
			ForceON			
13	Ch 7-0: Hold State for Fieldbus Idle*2*3*6	Sets hold status when Fieldbus Communication idle is occurred.	Hold	○	0: Hold the output 1: Depend on output state Bit0 : Channel 0 : Bit7 : Channel 7	Channel
			Depend on Fault Digital Value			
14	Ch 15-8: Hold State for Fieldbus Idle*2*3*6		Hold	○	0: Hold the output 1: Depend on output state Bit0 : Channel 8 : Bit7 : Channel 15	Channel
			Depend on Fault Digital Value			
15	Ch 7-0: Output state for Fieldbus Idle*2*3*6*7	Sets output status when Fieldbus Communication idle is occurred.	Clear	○	0: Turn off the output 1: Turn on the output forcefully Bit0 : Channel 0 : Bit7 : Channel 7	Channel
			ForceON			
16	Ch 15-8: Output state for Fieldbus Idle*2*3*6*8		Clear	○	0: Turn off the output 1: Turn on the output forcefully Bit0 : Channel 8 : Bit7 : Channel 15	Channel
			ForceON			
17	Ch 7-0: Hold State for RF Timeout*9	Sets hold status when Wireless Communication timeout is occurred.	Hold	○	0: Hold the output 1: Depend on output state Bit0 : Channel 0 : Bit7 : Channel 7	Channel
			Depend on Fault Digital Value			

No.	Name	Definition	Item	Default setting	Content	Parameter setting range
18	Ch 15-8: Hold State for RF Timeout* ⁹	Sets hold status when Wireless Communication timeout is occurred.	Hold	○	0: Hold the output 1: Depend on output state Bit0 : Channel 8 : Bit7 : Channel 15	Channel
			Depend on Fault Digital Value			
19	Ch 7-0: Output state for RF Timeout* ^{9*10}	Sets output status when Wireless Communication timeout is occurred.	0:Clear	○	0: Turn off the output 1: Turn on the output forcefully Bit0 : Channel 0 : Bit7 : Channel 7	Channel
			1:ForceON			
20	Ch 15-8: Output state for RF Timeout* ^{9*11}	Sets output status when Wireless Communication timeout is occurred.	0:Clear	○	0: Turn off the output 1: Turn on the output forcefully Bit0 : Channel 8 : Bit7 : Channel 15	Channel
			1:ForceON			
21	Ch 7-0: ON/OFF Counter Limit Detection	Generates error when the operation count exceeds the set value * ¹²	1 : Enable	○	1: Generates an error. 0; Does not generate an error. Bit0 : Channel 0 : Bit7 : Channel 7	Channel
			0 : Disable			
22	Ch 15-8: ON/OFF Counter Limit Detection	Generates error when the operation count exceeds the set value * ¹²	1 : Enable	○	1: Generates an error. 0; Does not generate an error. Bit0 : Channel 8 : Bit7 : Channel 15	Channel
			0 : Disable			
23	Ch #: Counter Limit Value (1k-65000k)	Counter Limit Value	1~65000	-	Times for setting is set value x1000 times	Channel

*1: Could be incorrectly recognized as short circuit depending on used load (ex.: lamp load). If detection is incorrect, disable the parameter setting.

*2: This function is valid only when "Unit: Output State Fieldbus FaultIdle" of Wireless Base is set to "Individual".

*3: This function is valid only when "Unit: Output State Fieldbus FaultIdle" of Wireless Remote is set to "Individual".

*4: This function is valid only when "Ch 7-0: Hold State for Fieldbus Fault" is set to " Depend on Output state Digital Value"(1).

*5: This function is valid only when "Ch 15-8 Hold State for Fieldbus Fault" is set to " Depend on Output state Digital Value"(1).

*6: Some PLC does not support an idle mode.

*7: This function is valid only when "Ch 7-0: Hold State for Fieldbus Idle" is set to " Depend on Output state Digital Value"(1).

*8: This function is valid only when "Ch 15-8: Hold State for Fieldbus Idle" is set to " Depend on Output state Digital Value"(1).

*9: This function is valid only when "Unit: Output State for RF Timeout " is set to " Individual ".

*10: This function is valid only when "Ch 7-0: Hold State for RF Timeout " is set to " Depend on Output state Digital Value"(1).

*11: This function is valid only when "Ch 15-8: Hold State for RF Timeout " is set to " Depend on Output state Digital Value"(1).

*12: The count is stored once every hour or when the power supply drops below approx. 19 V. When the power supply is restored, counting starts from the last value stored.

Diagnostics:

Index	Name	Type	Default Value
Digital Output			
0xAMM0:00	Rem.#: Diags	USINT	38
0xAMM0:01 * ¹ -0xAMM0:10 * ¹	Ch #:ON/OFF Counter Value	UDINT	0
0xAMM0:11 * ¹ -0xAMM0:20 * ¹	Ch #:ON/OFF Counter Clear	USINT	0
0xAMM0:21	Ch 7-0:Exceeded ON/OFF Counter Limit	USINT	0
0xAMM0:22	Ch 15-8:Exceeded ON/OFF Counter Limit	USINT	0
0xAMM0:23	Ch 7-0:Open Circuit Detection	USINT	0
0xAMM0:24	Ch 15-8:Open Circuit Detection	USINT	0
0xAMM0:25	Ch 7-0:Short Circuit Detection (Output)	USINT	0
0xAMM0:26	Ch 15-8: Short Circuit Detection (Output)	USINT	0

^{MM} Wireless channel – 1

*¹ One of these parameters are generated for every channels

• Diagnostics details

No.	Name	Definition	Type	Value
1	Ch #: ON/OFF Counter Value	ON/OFF count upper limit value *1	UDINT	0 – 4294967295 (0 to 0xFFFFFFFF)
2	Ch #: ON/OFF Counter Clear	Clears the Input ON/OFF counter to 0.	USINT	Set to 0
3	Ch 7-0: Exceeded ON/OFF Counter Limit	ON/OFF count of the valve has exceeded the set value. Channel diagnosis Ch0 to Ch7	BYTE	0: No error 1: Error Bit0: There is an error in channel 0. : Bit7: There is an error in channel 7.
4	Ch 15-8: Exceeded ON/OFF Counter Limit	ON/OFF count of the valve has exceeded the set value. Channel diagnosis Ch8 to Ch15	BYTE	0: No error 1: Error Bit0: There is an error in channel 8. : Bit7: There is an error in channel 15.
5	Ch 7-0: Open Circuit Detection*2	The output device wiring is disconnected. Channel diagnosis Ch0 to Ch7	BYTE	0: No error 1: Error Bit0: There is an error in channel 0. : Bit7: There is an error in channel 7.
6	Ch 15-8: Open Circuit Detection*2	The output device wiring is disconnected. Channel diagnosis Ch8 to Ch15	BYTE	0: No error 1: Error Bit0: There is an error in channel 8. : Bit7: There is an error in channel 15.
7	Ch 7-0: Short Circuit Detection (Input)	The short circuit of the power supply for the input device has been detected. Channel diagnosis Ch0 to Ch7	BYTE	0: No error 1: Error Bit0: There is an error in channel 0. : Bit7: There is an error in channel 7.
8	Ch 15-8: Short Circuit Detection (Input)	The short circuit of the power supply for the input device has been detected. Channel diagnosis Ch8 to Ch15	BYTE	0: No error 1: Error Bit0: There is an error in channel 8. : Bit7: There is an error in channel 15.

*1: The count is stored once every hour or when the power supply drops below approx. 19 V. When the power supply is restored, counting starts from the last value stored.

EXW1-RDM*

Parameter settings:

Index	Name	Type	Default Value
0x8MM2:00	Rem.#: Params	USINT	4
0x8MM2:01	Unit: Power Supply Voltage Monitor US1	ENUM0FFF	Enable
0x8MM2:02	Unit: Power Supply Voltage Monitor US2	ENUM0FFF	Disable
0x8MM2:03	Unit: Output State Fieldbus FaultIdle	ENUM0FFC	Clear
0x8MM2:04	Unit: Output State for RF Timeout	ENUM0FFC	Hold
Digital Input			
0x8MM0:00	Rem.#: Params	USINT	14
0x8MM0:01	Unit: Short Circuit Detection(Power)	ENUM0FFF	Enable
0x8MM0:02	Unit: Inrush Current Filter	ENUM0FFF	Enable
0x8MM0:03	Unit: Input Filtering Time	ENUM0FFE	1
0x8MM0:04	Unit: Input Extension Time	ENUM0FFD	15
0x8MM0:05	Ch 7-0:Open Circuit Detection	USINT	0(Disable)
0x8MM0:06	Ch 7-0:ON/OFF Counter Limit Detection	USINT	0(Disable)
0x8MM0:07* ¹ -0x8MM0:0E* ¹	Ch #:Counter Limit Value(1k-65000k)	UINT	65000
Digital Output			
0x8MM1:00	Rem.#: Params	USINT	18
0x8MM1:01	Unit: Short Circuit Detection(Output)	ENUM0FFF	Enable
0x8MM1:02	Unit: Restart After Short Circuit	ENUM0FFF	Enable
0x8MM1:03	Ch 7-0:Hold State for Fieldbus Fault	USINT	255
0x8MM1:04	Ch 7-0:Output State for Fieldbus Fault	USINT	0(Clear)
0x8MM1:05	Ch 7-0:Hold State for Fieldbus Idle	USINT	255
0x8MM1:06	Ch 7-0:Output State for Fieldbus Idle	USINT	0(Clear)
0x8MM1:07	Ch 7-0:Hold State for RF Timeout	USINT	0(Clear)
0x8MM1:08	Ch 7-0:Output State for RF Timeout	USINT	0(Clear)
0x8MM0:09	Ch 7-0:Open Circuit Detection	USINT	0(Disable)
0x8MM0:0A	Ch 7-0:ON/OFF Counter Limit Detection	USINT	0(Disable)
0x8MM1:0B* ¹ -0x8MM1:12* ¹	Ch #:Counter Limit Value(1k-65000k)	UINT	65000

^{MM} Wireless channel – 1

*¹ One of these parameters are generated for every channels

Parameter details

The parameter definitions for EXW1-RDM are the same as EXW1-RDX and EXW1-RDY. Please refer to the parameter settings for EXW1-RDX* and EXW1-RDY*.

Diagnostics:

Index	Name	Type	Default Value
Digital Input			
0xAMM0:00	Diags	USINT	19
0xAMM0:01* ¹ -0xAMM0:08* ¹	Ch #:ON/OFF Counter Value	UDINT	0
0xAMM0:09* ¹ -0xAMM0:10* ¹	Ch #:ON/OFF Counter Clear	USINT	0
0xAMM0:11	Ch 7-0:Exceeded ON/OFF Counter Limit	USINT	0
0xAMM0:12	Ch 7-0:Open Circuit Detection	USINT	0
0xAMM0:13	Ch 7-0:Short Circuit Detection(Input)	USINT	0
Digital Output			
0xAMM1:00	Diags	USINT	19
0xAMM1:01* ¹ -0xAMM1:08* ¹	Ch #:ON/OFF Counter Value	UDINT	0
0xAMM1:09* ¹ -0xAMM1:10* ¹	Ch #:ON/OFF Counter Clear	USINT	0
0xAMM1:11	Ch 7-0:Exceeded ON/OFF Counter Limit	USINT	0
0xAMM1:12	Ch 7-0:Open Circuit Detection	USINT	0
0xAMM1:13	Ch 7-0:Short Circuit Detection(Output)	USINT	0

^{MM} Wireless channel – 1

*¹ One of these parameters are generated for every channels

• Diagnostics details

The parameter definitions for EXW1-RDM are the same as EXW1-RDX and EXW1-RDY. Please refer to the diagnostic information for EXW1-RDX* and EXW1-RDY*.

Specifications

Dimensions

○EXW1-BECAC

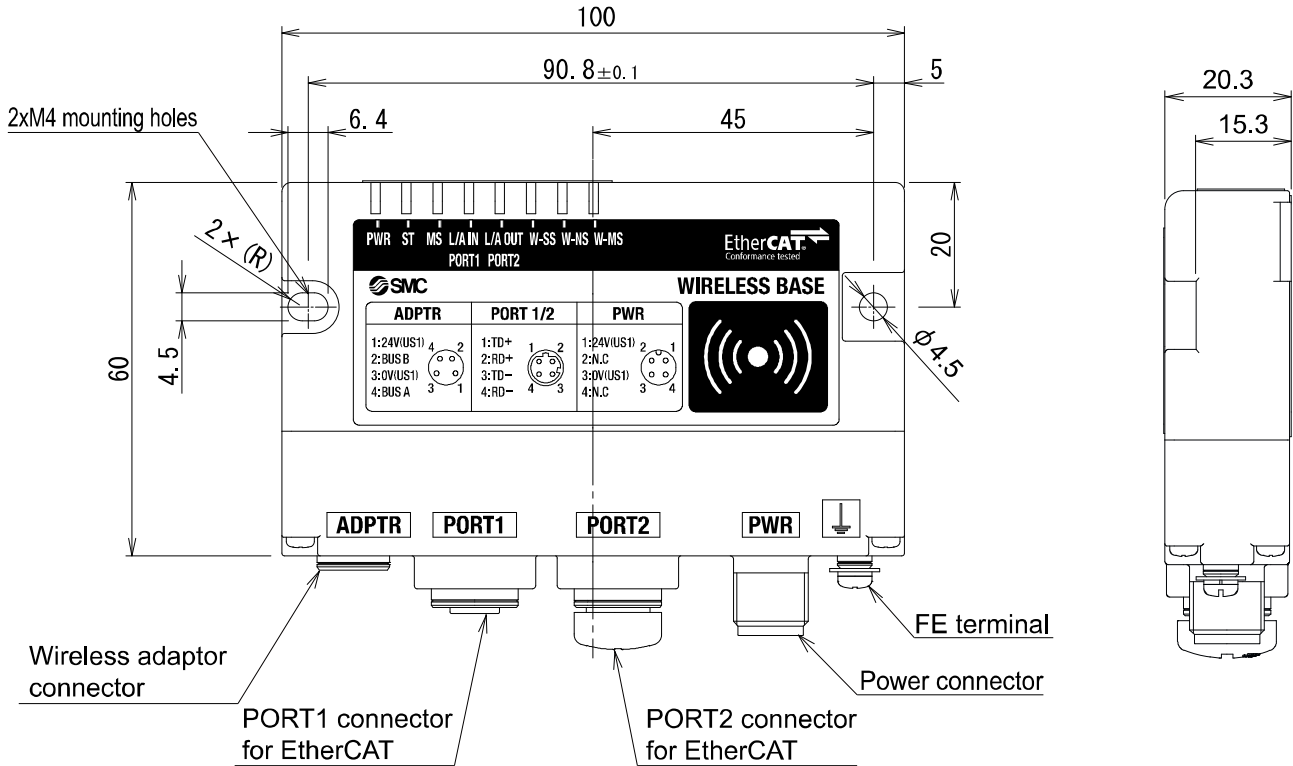

oEXW1-A11*

• Wireless Adaptor

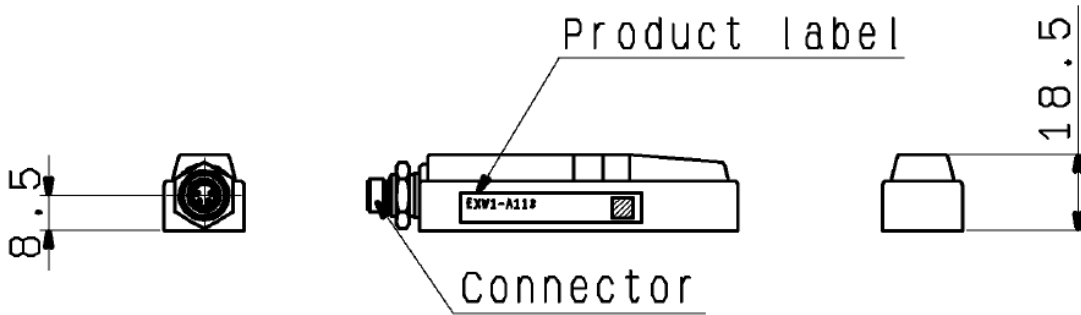
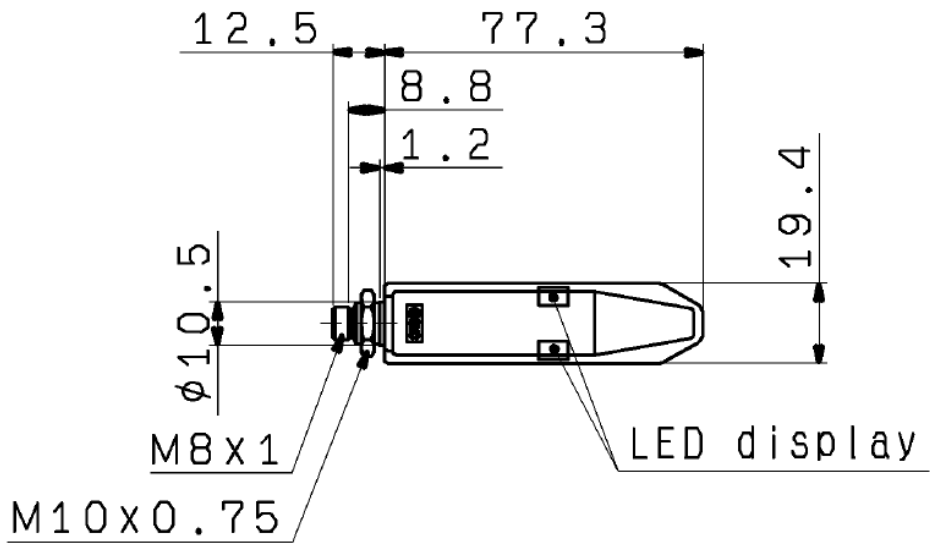

• Installation Plate

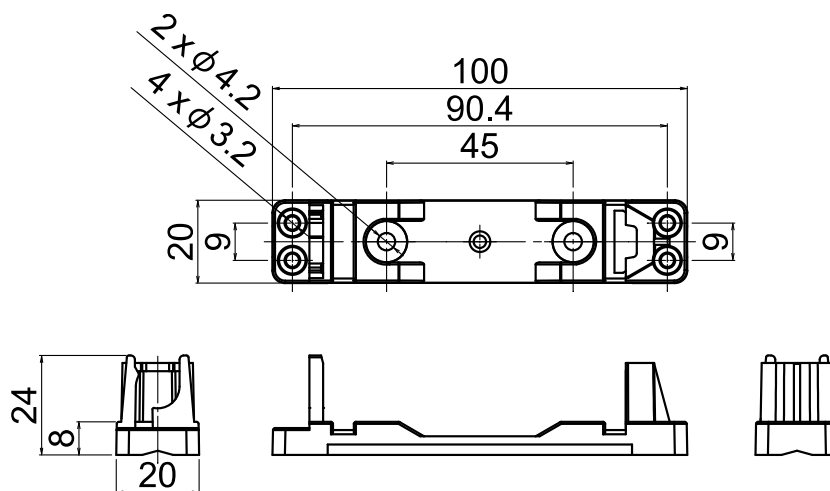

oEXW1-RD*

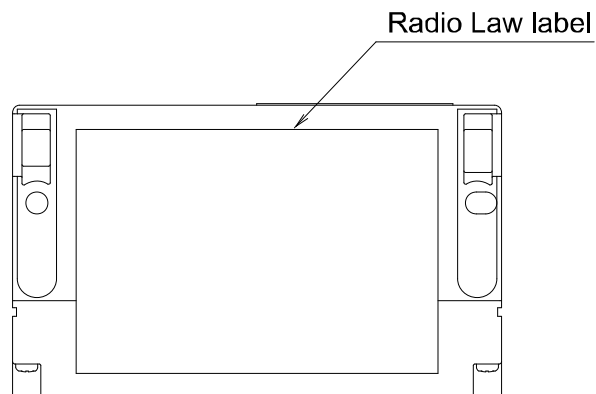
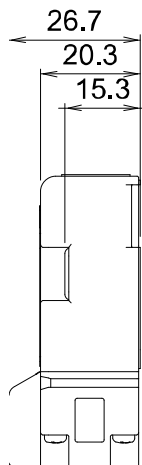
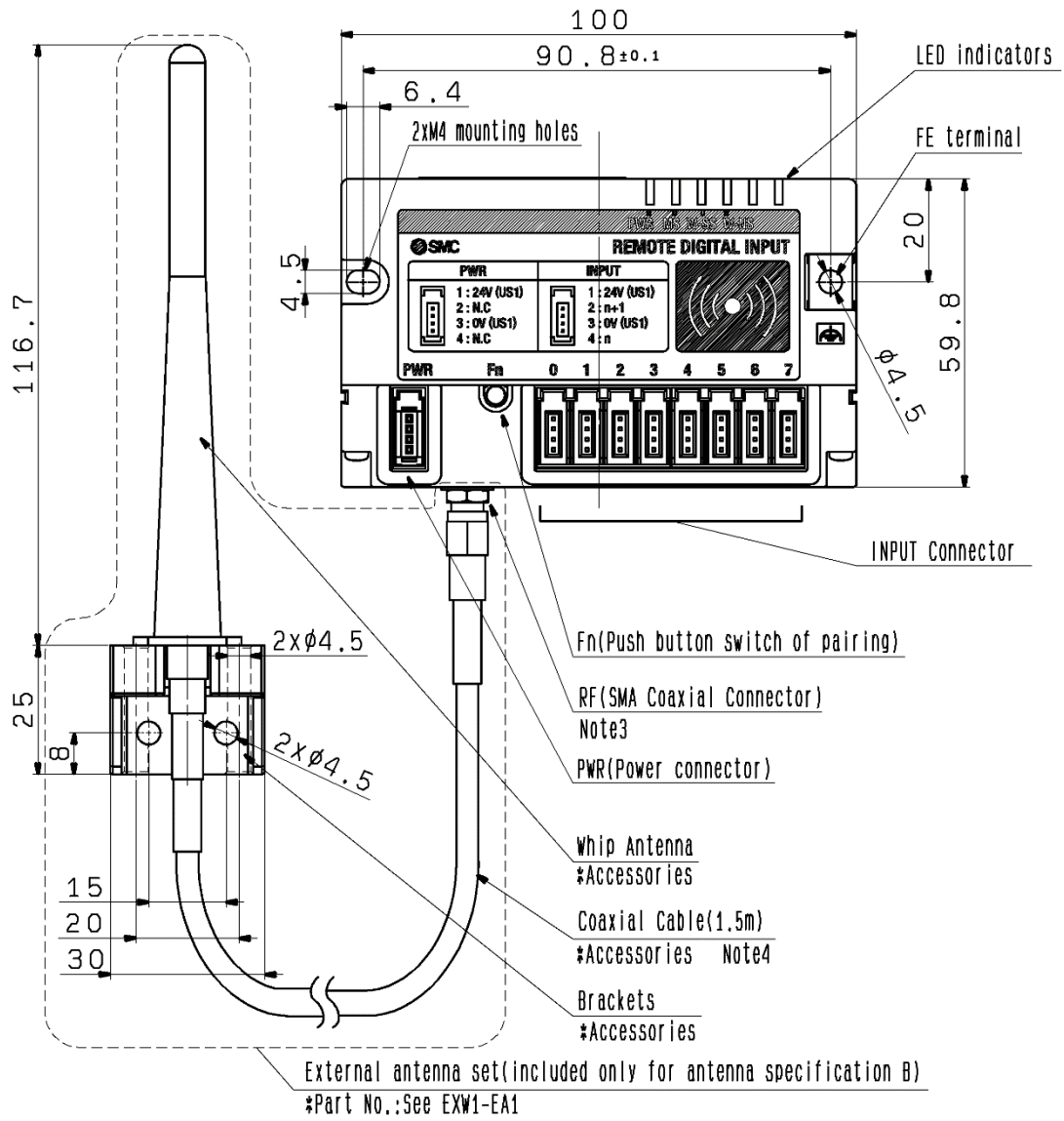

Specifications Table

○EXW1-BECAC

EtherCAT communication specifications

Item	Specification
Protocol	EtherCAT (Conformance Test Record V.2.3.0)
Transmission speed	100 Mbps
Occupied area (Inputs/ outputs)	Max. 11784 / 11784 (1473 byte / 1473 byte)
Configuration file	ESI file *1
Configuration	Online *2

*1: The setting file can be downloaded from the SMC Web site

*2: The control component (PLC etc..) should be supported an online configuration.

Electrical specifications

Item	Specification
US1 (for control) power supply voltage range	24 VDC+/-10 %
Current consumption	150 mA or less

General specifications

Item	Specification
Enclosure	IP67
Ambient operating temperature	-10 to +50°C
Ambient storage temperature	-20 to +60°C
Ambient humidity	35 to 85% RH (no condensation)
Withstand voltage	500 VAC 1.0 min. External terminals (including the FE terminal) and enclosure screws
Insulation resistance	10 MΩ or more 500 VDC External terminals (including the FE terminal) and enclosure screws
Vibration resistance	EN61131-2 compliant 5 ≤ f < 8.4 Hz 3.5 mm 8.4 ≤ f < 150 Hz 9.8 m/s ²
Impact resistance	EN61131-2 compliant, 147 m/s ² , 11 ms
Mounting	Through hole for M4 screw (2 pcs.)
Standards	CE/UKCA marked, UL (CSA)
Weight	150 g (body),

○EXW1-A11*

Electrical specifications

Item	Specification
US1 (for control) power supply voltage range	24 VDC+/-10 %
Current consumption	50 mA or less

General specifications

Item	Specification
Enclosure	IP67
Ambient operating temperature	-10 to +50°C
Ambient storage temperature	-20 to +60°C
Ambient humidity	35 to 85% RH (no condensation)
Vibration resistance	EN61131-2 compliant 5 ≤ f < 8.4 Hz 3.5 mm 8.4 ≤ f < 150 Hz 9.8 m/s ²
Impact resistance	EN61131-2 compliant, 147 m/s ² , 11 ms
Standards	CE/UKCA marked, UL (CSA)*1
Weight	40 g (body), 20 g (installation plate)

*1: When connect to the air management system and EXW1-BECAC, UL (CSA) standards applies.

Wireless communication specifications

Item	Specification
Protocol	SMC original protocol (SMC encryption)
Radio wave type (spread)	Frequency Hopping Spread Spectrum (FHSS)
Frequency band	2.4 GHz (2403~2481 MHz)
Frequency channel select function (F.C.S.)	Supported *1
Frequency channel	Max. 79 ch (Bandwidth: 1.0 MHz)
Communication speed	250 kbps(V.1.0) / 1 Mbps(V.2.0) *2
Frequency hopping cycle	5ms(V.1.0) / 2ms(V.2.0)
Communication distance	Up to 100 m line of sight (depending on the environment)
Radio Law certificate	Refer to the official SMC website for the latest information as to which countries the product is certified.

*1: The number of selectable frequency channels varies depending on the product number.

*2: Select a protocol before performing pairing (V.2.0: 1 Mbps, V.1.0: 250 kbps). Different communication speeds are mutually incompatible.

○EXW1-RDX*

The wireless communication specifications are the same as EXW1-A11*.

General specifications

Item	Specification
Enclosure	IP20
Ambient operating temperature	-10 to +50°C
Ambient storage temperature	-20 to +60°C
Ambient humidity	35 to 85% RH (no condensation)
Withstand voltage	500 VAC 1.0 min. External terminals (including the FE terminal) and enclosure screws
Insulation resistance	10 MΩ or more 500 VDC External terminals (including the FE terminal) and enclosure screws
Vibration resistance	EN61131-2 compliant 5 ≤ f < 8.4 Hz 3.5 mm 8.4 ≤ f < 150 Hz 9.8 m/s ²
Impact resistance	EN61131-2 compliant, 147 m/s ² , 11 ms
Mounting	Through hole for M4 screw (2 pcs.)
Standards	CE/UKCA marked
Weight	130 g (body), 100 g (external antenna set)

Electrical specifications

Item	Specification	
US1 (for control / input) power voltage drop	24 VDC +/-10%	
Current consumption	100 mA or less	
Input specification	Number of points	16 points (2 points / connector)
	Output type	NPN
	Connector type	e-CON (4 pins)
	Max. supply current for sensor	0.3 A / connector, 2 A/unit
	ON current	Typ 0.5 mA
	OFF current	2 mA or less
	ON voltage	11 V or more
	OFF current	5 V or less
Short circuit protection function	Available	

○EXW1-RDY*

The wireless communication specifications are the same as EXW1-A11*.

General specifications

Item	Specification
Enclosure	IP20
Ambient operating temperature	-10 to +50°C
Ambient storage temperature	-20 to +60°C
Ambient humidity	35 to 85% RH (no condensation)
Withstand voltage	500 VAC 1.0 min. External terminals (including the FE terminal) and enclosure screws
Insulation resistance	10 MΩ or more 500 VDC External terminals (including the FE terminal) and enclosure screws
Vibration resistance	EN61131-2 compliant 5 ≤ f < 8.4 Hz 3.5 mm 8.4 ≤ f < 150 Hz 9.8 m/s ²
Impact resistance	EN61131-2 compliant, 147 m/s ² , 11 ms
Mounting	Through hole for M4 screw (2 pcs.)
Standards	CE/UKCA marked
Weight	130 g (body), 100 g (external antenna set)

Electrical specifications

Item	Specification	
US1 (for control / input) power voltage drop	24 VDC +/-10%	
US2 (for output) power voltage	24 VDC +/-10%	
Current consumption (US1)	100 mA or less	
Output specifications	Number of points	16 points (2 points / connector)
	Output type	NPN
	Connector type	e-CON (4 pins)
	Maximum load current	0.3 A / point, 2 A / unit
	Short circuit protection function	Available

○EXW1-RDM*

The wireless communication specifications are the same as EXW1-A11*.

General specifications

Item	Specification
Enclosure	IP20
Ambient operating temperature	-10 to +50°C
Ambient storage temperature	-20 to +60°C
Ambient humidity	35 to 85% RH (no condensation)
Withstand voltage	500 VAC 1.0 min. External terminals (including the FE terminal) and enclosure screws
Insulation resistance	10 MΩ or more 500 VDC External terminals (including the FE terminal) and enclosure screws
Vibration resistance	EN61131-2 compliant 5 ≤ f < 8.4 Hz 3.5 mm 8.4 ≤ f < 150 Hz 9.8 m/s ²
Impact resistance	EN61131-2 compliant, 147 m/s ² , 11 ms
Mounting	Through hole for M4 screw (2 pcs.)
Standards	CE/UKCA marked
Weight	130 g (body), 100 g (external antenna set)

Electrical specifications

Item	EXW1-RDMP*	EXW1-RDMN*	
US1 (for control / input) power voltage drop	24 VDC +/-10%		
US2 (for output) power voltage)	24 VDC +/-10%		
Current consumption (US1)	100 mA or less		
Input specifications	Number of points	8 points (2 points/connector)	
	Output type	PNP NPN	
	Connector type	e-CON (4 pins)	
	Max. supply current for sensor	0.3 A / connector, 1 A / unit	
	ON current	Typ 0.5 mA	
	OFF current	2 mA or less	
	ON voltage	11 V or more	
	OFF current	5 V or less	
Short circuit protection function	Available		
Output specifications	Number of points	8 points (2 points / connector)	
	Output type	PNP NPN	
	Connector type	e-CON (4 pins)	
	Maximum load current	0.3 A / point, 2 A / unit	
	Short circuit protection function	Available	

Accessories

Accessory List

For the selection of accessories, refer to the catalog.

(1) Power supply cables

- EX500-AP010-S: Cable with M12 connector, A code, Socket, Straight 1 m
- EX500-AP050-S: Cable with M12 connector, A code, Socket, Straight 5 m
- EX500-AP010-A: Cable with M12 connector, A code, Socket, Angle 1 m
- EX500-AP050-A: Cable with M12 connector, A code, Socket, Angle 5 m
- PCA-1401804: Cable with M12 connector, A code, Socket, Straight 1.5 m, SPEEDCON compatible
- PCA-1401805: Cable with M12 connector, A code, Socket, Straight 3 m, SPEEDCON compatible
- PCA-1401806: Cable with M12 connector, A code, Socket, Straight 5 m, SPEEDCON compatible
- PCA-1557769: Cable with M12 connector, A code, Socket, Plug, Straight 3 m, SPEEDCON compatible

(2) EtherCAT communication cable

- PCA-1446566: Cable with M12 connector, D code, Plug, Straight 5 m, SPEEDCON compatible
- EX9-AC010EN-PSRJ: Cable with M12 connector, D code-RJ45, Plug, Straight 1 m
- EX9-AC020EN-PSRJ: Cable with M12 connector, D code-RJ45, Plug, Straight 2 m
- EX9-AC030EN-PSRJ: Cable with M12 connector, D code-RJ45, Plug, Straight 3 m
- EX9-AC050EN-PSRJ: Cable with M12 connector, D code-RJ45, Plug, Straight 5 m
- EX9-AC100EN-PSRJ: Cable with M12 connector, D code-RJ45, Plug, Straight 10 m
- EX9-AC005EN-PSPS: Cable with M12 connector, dual-side D code Plug, Straight 0.5 m
- EX9-AC010EN-PSPS: Cable with M12 connector, dual-side D code Plug, Straight 1 m
- EX9-AC020EN-PSPS: Cable with M12 connector, dual-side D code Plug, Straight 2 m
- EX9-AC030EN-PSPS: Cable with M12 connector, dual-side D code Plug, Straight 3 m
- EX9-AC050EN-PSPS: Cable with M12 connector, dual-side D code Plug, Straight 5 m
- EX9-AC100EN-PSPS: Cable with M12 connector, dual-side D code Plug, Straight 10 m
- EX9-AC005EN-PAPA: Cable with M12 connector, dual-side D code Plug, Angle 0.5 m
- EX9-AC010EN-PAPA: Cable with M12 connector, dual-side D code Plug, Angle 1 m
- EX9-AC020EN-PAPA: Cable with M12 connector, dual-side D code Plug, Angle 2 m
- EX9-AC030EN-PAPA: Cable with M12 connector, dual-side D code Plug, Angle 3 m
- EX9-AC050EN-PAPA: Cable with M12 connector, dual-side D code Plug, Angle 5 m
- EX9-AC100EN-PAPA: Cable with M12 connector, dual-side D code Plug, Angle 10 m

(3) Assembled type connector

- PCA-1446553: For EtherCAT communication, M12 (4 pin) Plug, D code

(4) Seal cap (M12)

- EX9-AWTS

(5) Wireless adaptor cable

- EXW1-AC001-SAPU: 100mm U-shaped, Angle cable with M8 connector on both sides
- EXW1-AC030-SSPS: 3000mm straight cable with M8 connector on both sides
- EXW1-AC1-X1: 300mm straight cable with M8 connector on both sides

(6) External antenna set
EXW1-EA1

This set includes a whip antenna, a coaxial cable (1.5 m), a bracket and two screws (M2.6 x 8).

(7)e-CON
ZS-28-□

e-CON connector Part No.	AWG No.	Conductor cross sectional area (mm SQ)	Wire O.D. (mm)	Color of cover
ZS-28-C-1	24~26	0.14~0.2	ø1.0~ø1.2	Yellow
ZS-28-C-2			ø1.2~ø1.6	Orange
ZS-28-C-3	22~20	0.3~0.5	ø1.0~ø1.2	Green
ZS-28-C-4			ø1.2~ø1.6	Blue
ZS-28-C-5	-	0.1~0.5	ø1.6~ø2.0	Grey
ZS-28-CA-1			ø0.6~ø0.9	Orange
ZS-28-CA-2			ø0.9~ø1.0	Red
ZS-28-CA-3			ø1.0~ø1.15	Yellow
ZS-28-CA-4			ø1.15~ø1.35	Blue
ZS-28-CA-5			ø1.35~ø1.6	Green

(8) NFC reader/writer
EXW1-NT1

This set includes an NFC reader/writer and a USB extension cable (2.95 m).

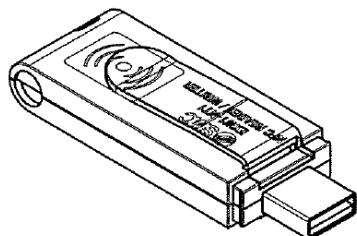

(9) NFC reader/writer holder
EXW1-AB1 (for EX600-W)

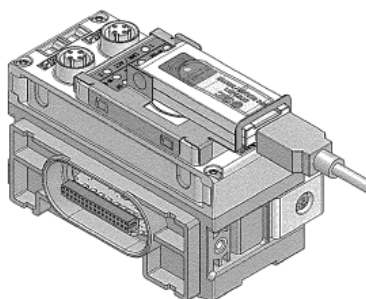
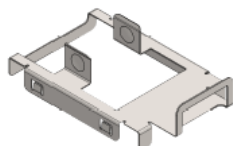

EXW1-AB2 (for EXW1)

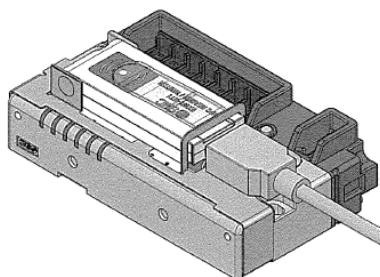
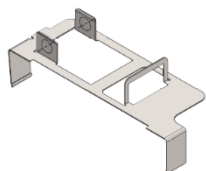

Revision history

A: Contents are added. [Aug 2023]
B: Contents are added. [Sep 2023]
C: Contents are revised. [Nov 2023]
D: Content changes. [May 2024]

SMC Corporation

Tel: + 81 3 5207 8249 Fax: +81 3 5298 5362

URL <https://www.smcworld.com>

Note: Specifications are subject to change without prior notice and any obligation on the part of the manufacturer.
EtherCAT® is a registered trademark and patented technology, licensed by Beckhoff Automation GmbH, Germany.
© 2023-2024 SMC Corporation All Rights Reserved

