



# Operation Manual

PRODUCT NAME

SI unit for PROFINET

MODEL / Series / Product Number

*EX260 Series*

**SMC Corporation**

## Table of Contents

Safety Instructions	2
Model Indication and How to Order	8
Summary of Product elements	9
Installation and Wiring	10
Installation	10
Wiring	11
LED Indication and Settings	15
Configuration	16
Troubleshooting and Maintenance	26
Specifications	31
Specifications	31
Dimensions	33
Accessories	34



# Safety Instructions

These safety instructions are intended to prevent hazardous situations and/or equipment damage. These instructions indicate the level of potential hazard with the labels of “**Caution**,” “**Warning**” or “**Danger**.” They are all important notes for safety and must be followed in addition to International Standards (ISO/IEC)<sup>\*1</sup>, and other safety regulations.

\*1) ISO 4414: Pneumatic fluid power - General rules and safety requirements for systems and their components  
ISO 4413: Hydraulic fluid power - General rules and safety requirements for systems and their components  
IEC 60204-1: Safety of machinery - Electrical equipment of machines - Part 1: General requirements  
ISO 10218-1: Robots and robotic devices - Safety requirements for industrial robots - Part 1: Robots  
etc.

	<b>Danger</b>	<b>Danger</b> indicates a hazard with a high level of risk which, if not avoided, will result in death or serious injury.
	<b>Warning</b>	<b>Warning</b> indicates a hazard with a medium level of risk which, if not avoided, could result in death or serious injury.
	<b>Caution</b>	<b>Caution</b> indicates a hazard with a low level of risk which, if not avoided, could result in minor or moderate injury.

## **Warning**

- 1. The compatibility of the product is the responsibility of the person who designs the equipment or decides its specifications.**  
Since the product specified here is used under various operating conditions, its compatibility with specific equipment must be decided by the person who designs the equipment or decides its specifications based on necessary analysis and test results. The expected performance and safety assurance of the equipment will be the responsibility of the person who has determined its compatibility with the product. This person should also continuously review all specifications of the product referring to its latest catalog information, with a view to giving due consideration to any possibility of equipment failure when configuring the equipment.
- 2. Only personnel with appropriate training should operate machinery and equipment.**  
The product specified here may become unsafe if handled incorrectly. The assembly, operation and maintenance of machines or equipment including our products must be performed by an operator who is appropriately trained and experienced.
- 3. Do not service or attempt to remove product and machinery/equipment until safety is confirmed.**
  1. The inspection and maintenance of machinery/equipment should only be performed after measures to prevent falling or runaway of the driven objects have been confirmed.
  2. When the product is to be removed, confirm that the safety measures as mentioned above are implemented and the power from any appropriate source is cut, and read and understand the specific product precautions of all relevant products carefully.
  3. Before machinery/equipment is restarted, take measures to prevent unexpected operation and malfunction.
- 4. Our products cannot be used beyond their specifications. Our products are not developed, designed, and manufactured to be used under the following conditions or environments. Use under such conditions or environments is not covered.**
  1. Conditions and environments outside of the given specifications, or use outdoors or in a place exposed to direct sunlight.
  2. Use for nuclear power, railways, aviation, space equipment, ships, vehicles, military application, equipment affecting human life, body, and property, fuel equipment, entertainment equipment, emergency shut-off circuits, press clutches, brake circuits, safety equipment, etc., and use for applications that do not conform to standard specifications such as catalogs and operation manuals.
  3. Use for interlock circuits, except for use with double interlock such as installing a mechanical protection function in case of failure. Please periodically inspect the product to confirm that the product is operating properly.



# Safety Instructions

## Caution

**We develop, design, and manufacture our products to be used for automatic control equipment, and provide them for peaceful use in manufacturing industries.**

**Use in non-manufacturing industries is not covered.**

Products we manufacture and sell cannot be used for the purpose of transactions or certification specified in the Measurement Act.

The new Measurement Act prohibits use of any unit other than SI units in Japan.

## Limited warranty and Disclaimer/Compliance Requirements

The product used is subject to the following “Limited warranty and Disclaimer” and “Compliance Requirements”.

Read and accept them before using the product.

### Limited warranty and Disclaimer

1. The warranty period of the product is 1 year in service or 1.5 years after the product is delivered, whichever is first.\*2)

Also, the product may have specified durability, running distance or replacement parts. Please consult your nearest sales branch.

2. For any failure or damage reported within the warranty period which is clearly our responsibility, a replacement product or necessary parts will be provided.

This limited warranty applies only to our product independently, and not to any other damage incurred due to the failure of the product.

3. Prior to using SMC products, please read and understand the warranty terms and disclaimers noted in the specified catalog for the particular products.

**\*2) Vacuum pads are excluded from this 1 year warranty.**

A vacuum pad is a consumable part, so it is warranted for a year after it is delivered.

Also, even within the warranty period, the wear of a product due to the use of the vacuum pad or failure due to the deterioration of rubber material are not covered by the limited warranty

### Compliance Requirements

1. The use of SMC products with production equipment for the manufacture of weapons of mass destruction (WMD) or any other weapon is strictly prohibited.

2. The exports of SMC products or technology from one country to another are governed by the relevant security laws and regulations of the countries involved in the transaction. Prior to the shipment of a SMC product to another country, assure that all local rules governing that export are known and followed.

## Operator

- ◆ This operation manual is intended for those who have knowledge of machinery using pneumatic equipment, and have sufficient knowledge of assembly, operation and maintenance of such equipment. Only those persons are allowed to perform assembly, operation and maintenance.
- ◆ Read and understand this operation manual carefully before assembling, operating or providing maintenance to the product.

### ■ Safety Instructions

#### **Warning**

- Do not disassemble, modify (including changing the printed circuit board) or repair.  
An injury or failure can result.
- Do not operate the product outside of the specifications.  
Do not use for flammable or harmful fluids.  
Fire, malfunction, or damage to the product can result.  
Verify the specifications before use.
- Do not operate in an atmosphere containing flammable or explosive gases.  
Fire or an explosion can result.  
This product is not designed to be explosion proof.
- If using the product in an interlocking circuit:
  - Provide a double interlocking system, for example a mechanical system.
  - Check the product regularly for proper operation.Otherwise malfunction can result, causing an accident.
- The following instructions must be followed during maintenance:
  - Turn off the power supply.
  - Stop the air supply, exhaust the residual pressure and verify that the air is released before performing maintenance.Otherwise an injury can result.

## **Caution**

- After maintenance is complete, perform appropriate functional inspections.  
Stop operation if the equipment does not function properly.  
Safety cannot be assured in the case of unexpected malfunction.
- Provide grounding to assure the noise resistance of the Serial System.  
Individual grounding should be provided close to the product with a short cable.

### ■ NOTE

- Follow the instructions given below when designing, selecting and handling the product.
- The instructions on design and selection (installation, wiring, environment, adjustment, operation, maintenance, etc.) described below must also be followed.
  - \*Product specifications
    - When conformity to UL is required, the SI unit should be used with a UL1310 Class 2 power supply.
    - The SI unit is a UL approved product only if they have a  mark on the body.
    - Use the specified voltage.  
Otherwise failure or malfunction can result.
    - Reserve a space for maintenance.  
Allow sufficient space for maintenance when designing the system.
    - Do not remove any nameplates or labels.  
This can lead to incorrect maintenance, or misreading of the operation manual, which could cause damage or malfunction to the product.  
It may also result in non-conformity to safety standards.

## ●Product handling

### \*Installation

- Do not drop, hit or apply excessive shock to the fieldbus system.  
Otherwise damage to the product can result, causing malfunction.
- Tighten to the specified tightening torque.  
If the tightening torque is exceeded the mounting screws may be broken.  
IP67 protection cannot be guaranteed if the screws are not tightened to the specified torque.
- Never mount a product in a location that will be used as a foothold.  
The product may be damaged if excessive force is applied by stepping or climbing onto it.

### \*Wiring

- Avoid repeatedly bending or stretching the cables, or placing heavy load on them.  
Repetitive bending stress or tensile stress can cause breakage of the cable.
- Wire correctly.  
Incorrect wiring can break the product.
- Do not perform wiring while the power is on.  
Otherwise damage to the fieldbus system and/or I/O device can result, causing malfunction.
- Do not route wires and cables together with power or high voltage cables.  
Otherwise the fieldbus system and/or I/O device can malfunction due to interference of noise and surge voltage from power and high voltage cables to the signal line.  
Route the wires (piping) of the fieldbus system and/or I/O device separately from power or high voltage cables.
- Confirm proper insulation of wiring.  
Poor insulation (interference from another circuit, poor insulation between terminals, etc.) can lead to excess voltage or current being applied to the product, causing damage.
- Take appropriate measures against noise, such as using a noise filter, when the fieldbus system is incorporated into equipment.  
Otherwise noise can cause malfunction.
- Separate the power line for output devices from the power line for control.  
Otherwise noise or induced surge voltage can cause malfunction.

### \*Environment

- Select the proper type of protection according to the environment of operation.  
IP67 protection is achieved when the following conditions are met.
  - (1) The units are connected properly with fieldbus cable with M12 connector and power cable with M12 (M8) connector.
  - (2) Suitable mounting of each unit and manifold valve.If using in an environment that is exposed to water splashes, please take measures such as using a cover.
- Do not use in a place where the product could be splashed by oil or chemicals.  
If the product is to be used in an environment containing oils or chemicals such as coolant or cleaning solvent, even for a short time, it may be adversely affected (damage, malfunction etc.).
- Do not use the product in an environment where corrosive gases or fluids could be splashed.  
Otherwise damage to the product and malfunction can result.
- Do not use in an area where surges are generated.  
If there is equipment which generates a large amount of surge (solenoid type lifter, high frequency induction furnace, motor, etc.) close to the fieldbus system, this may cause deterioration or breakage of the internal circuit of the fieldbus system. Avoid sources of surge generation and crossed lines.
- When a surge-generating load such as a relay or solenoid is driven directly, use an fieldbus system with a built-in surge absorbing element.  
Direct drive of a load generating surge voltage can damage the fieldbus system.
- The product is CE/UKCA marked, but not immune to lightning strikes. Take measures against lightning strikes in the system.
- Prevent foreign matter such as remnant of wires from entering the fieldbus system to avoid failure and malfunction.

- Mount the product in a place that is not exposed to excessive vibration or impact.  
Otherwise failure or malfunction can result.
- Do not use the product in an environment that is exposed to temperature cycle.  
Heat cycles other than ordinary changes in temperature can adversely affect the inside of the product.
- Do not expose the product to direct sunlight.  
If using in a location directly exposed to sunlight, shade the product from the sunlight.  
Otherwise failure or malfunction can result.
- Keep within the specified ambient temperature range.  
Otherwise malfunction can result.
- Do not operate close to a heat source, or in a location exposed to radiant heat.  
Otherwise malfunction can result.

\*Adjustment and Operation

- Perform settings suitable for the operating conditions.  
Incorrect setting can cause operation failure.
- Please refer to the PLC manufacturer's manual etc. for details of programming and addresses.  
For the PLC protocol and programming refer to the relevant manufacturer's documentation.
- The surface on the product may be hot.

\*Maintenance

- Turn off the power supply, stop the supplied air, exhaust the residual pressure and verify the release of air before performing maintenance.  
There is a risk of unexpected malfunction.
- Perform regular maintenance and inspections.  
There is a risk of unexpected malfunction.
- After maintenance is complete, perform appropriate functional inspections.  
Stop operation if the equipment does not function properly.  
Otherwise safety is not assured due to an unexpected malfunction or incorrect operation.
- Do not use solvents such as benzene, thinner etc. to clean the each unit.  
They could damage the surface of the body and erase the markings on the body.  
Use a soft cloth to remove stains.  
For heavy stains, use a cloth soaked with diluted neutral detergent and fully squeezed, then wipe up the stains again with a dry cloth.



# Model Indication and How to Order

EX260-SPN 1

- Connector type, output specification

1	M12 connector, 32 outputs, PNP (negative common) / source
2	M12 connector, 32 outputs, NPN (positive common) / sink
3	M12 connector, 16 outputs, PNP (negative common) / source
4	M12 connector, 16 outputs, NPN (positive common) / sink

- Fieldbus

PN	PROFINET
----	----------

## Summary of Product elements

<EX260-SPN1/-SPN2/-SPN3/-SPN4>

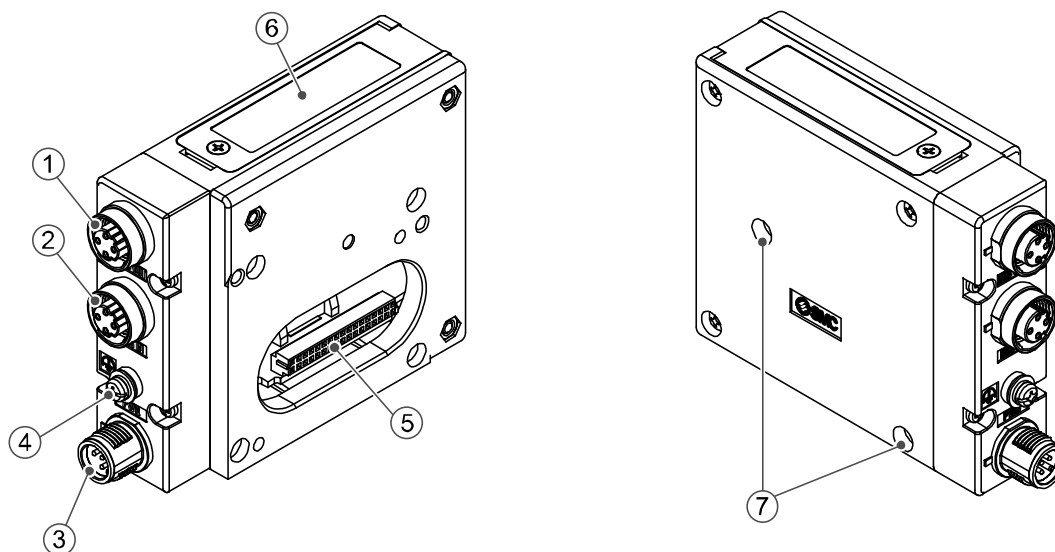

No.	Element	Description
1	Fieldbus interface connector (BUS OUT/Port2)	PROFINET connection PORT 2. *1 (M12 4-pin socket, D-coded)
2	Fieldbus interface connector (BUS IN/Port1)	PROFINET connection PORT 1. *1 (M12 4-pin socket, D-coded)
3	Power supply connector	Power supply with load voltage for valves and operating voltage for SI unit. *1 (M12 5-pin plug, A-coded)
4	FE terminal	Functional earth. (M3 screw)
5	Output connector	Output signal interface for valve manifold.
6	LED display	LED display to indicate the status of the SI unit. *2
7	Mounting hole	Mounting hole for connection to the valve manifold.

### Accessories

Hexagon socket head cap screw	2 pcs. M3 x 30 screw for connection to the valve manifold.
Seal cap	1 pc. seal cap for unused fieldbus interface connector (BUS OUT).

\*1: For details of suitable cables refer to the Accessories section on page 34.

\*2: Refer to page 15 for the LED Indication and Settings.

# Installation and Wiring

## ■ Installation

Connect valve manifold to the SI unit.

### • Dimensions for installation

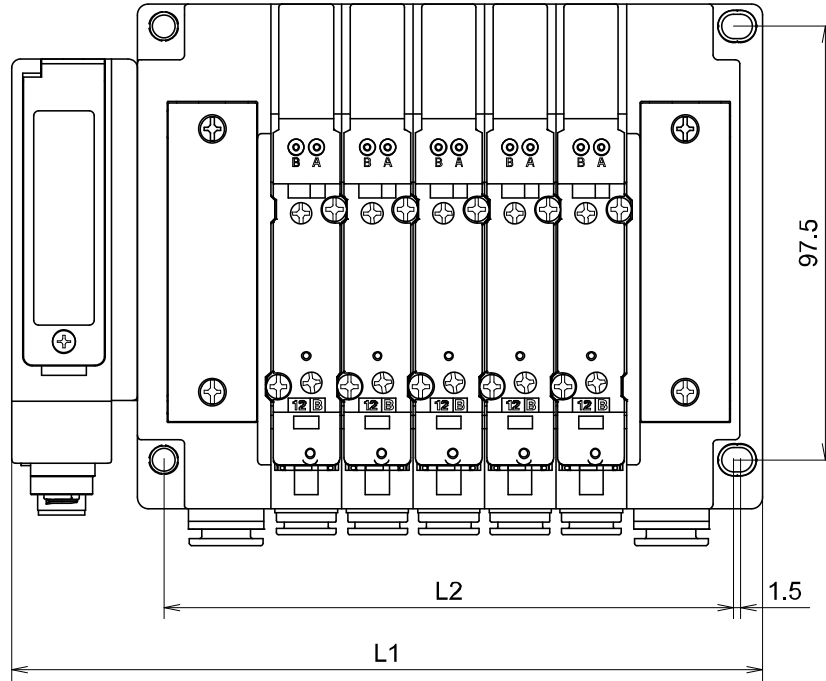

n: number of valve stations

L \ n	1	2	3	4	5	6	7	8	
L1		120.7	136.7	152.7	168.7	184.7	200.7	216.7	
L2		80	96	112	128	144	160	176	
L \ n	9	10	11	12	13	14	15	16	
L1		232.7	248.7	264.7	280.7	296.7	312.7	328.7	344.7
L2		192	208	224	240	256	272	288	304

(mm)

The above table shows dimensions as an example for the SY5000 series valve manifold.

Connectable valve manifolds are the same as for EX250 series SI unit.

Refer to the EX250 series valve manifold section in the valve catalogue for valve manifold dimensions.

## ■Wiring

Select the appropriate cables to mate with the connectors mounted on the SI unit.  
Refer to Accessories (page 34).

### ○Fieldbus interface connector layout

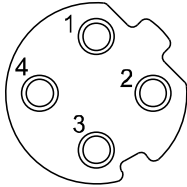

**BUS OUT/Port2: M12 4-pin socket, D-coded (SPEEDCON)**

No.	Designation	Description
1	TD+	Transmit Data +
2	RD+	Receive Data +
3	TD-	Transmit Data -
4	RD-	Receive Data -

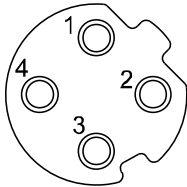

**BUS IN/Port1: M12 4-pin socket, D-coded (SPEEDCON)**

No.	Designation	Description
1	TD+	Transmit Data +
2	RD+	Receive Data +
3	TD-	Transmit Data -
4	RD-	Receive Data -

The M12 connector cable has two types, SPEEDCON compatible and non-compatible. If both plug and socket sides have connectors for SPEEDCON, the cable can be inserted and connected by turning it a 1/2 of a rotation, leading to reduction in work hour.  
A non-compatible connector can be connected to a compatible connector as well as an M12.

Connect the "BUS IN" connector to the upstream device (PLC etc.) and connect the "BUS OUT" connector to the downstream device.

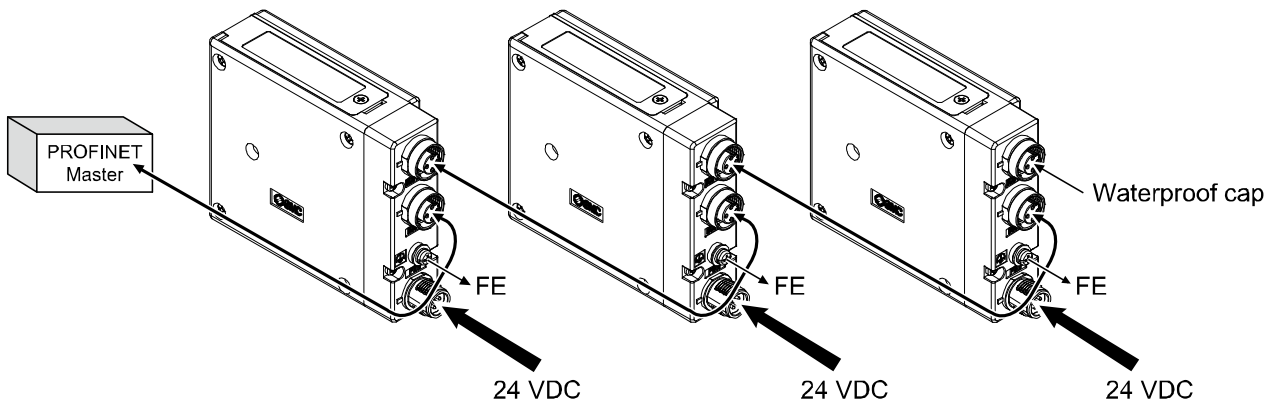

### Note

- Be sure to fit a seal cap on any unused connectors.  
Proper use of the seal cap enables the enclosure to achieve IP67 specification.

\*: Refer to page 35 for the seal cap.

○Power supply connector layout

PWR: M12 5-pin plug, A-coded (SPEEDCON)

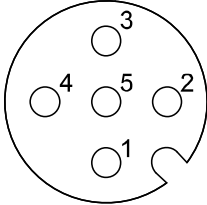

No.	Designation	Description
1	SV24 V	+24 V for solenoid valve
2	SV0 V	0 V for solenoid valve
3	SI24 V	+24 V for SI unit operation
4	SI0 V	0 V for SI unit operation
5	-	Unused

The M12 connector cable has two types, SPEEDCON compatible and non-compatible. If both plug and socket sides have connectors for SPEEDCON, the cable can be inserted and connected by turning it a 1/2 of a rotation, leading to reduction in work hour.  
A non-compatible connector can be connected to a compatible connector as well as an M12.

Power-supply line for solenoid valve and power-supply line for SI unit operation are isolated.  
Be sure to supply power, respectively.  
Either single-source power or two different power supplies can be used.

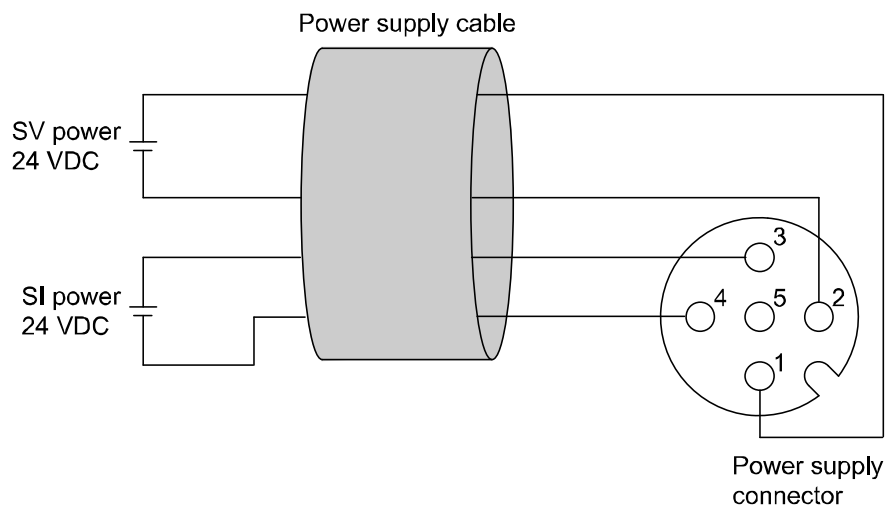

A. Two different power supply

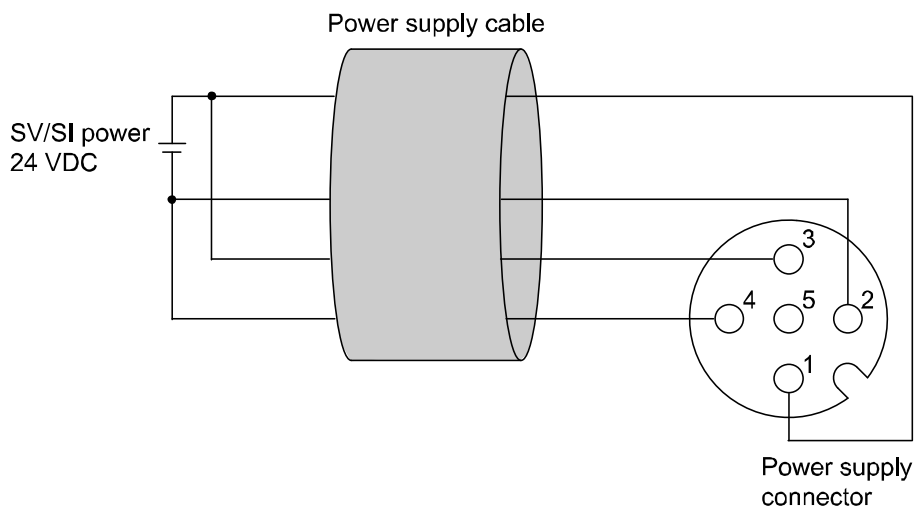

B. Single-source power supply

\*: Pay attention not to exceed the tolerance range of power supply voltage.

○FE terminal

Connect the FE terminal to ground.

Resistance to ground should be 100 ohms or less.

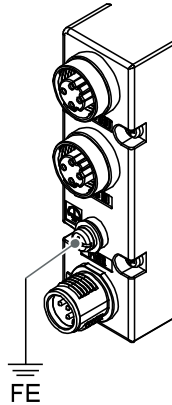

## LED Indication and Settings

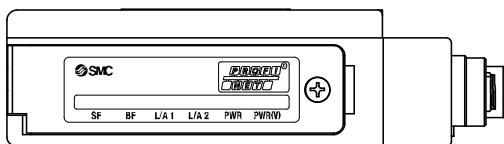

### LED indication

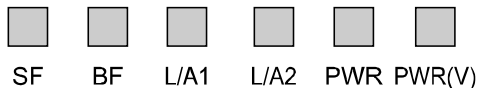

LED	LED Status	Description
SF	<input type="checkbox"/> OFF	Operating normally
	<input checked="" type="checkbox"/> Red ON	<ul style="list-style-type: none"> <li>•SI unit-related diagnostic error is detected (load power for the valve is not supplied or outside tolerance range)</li> <li>•The configuration information registered in the master and the number of output points does not match (BF flashing).</li> </ul>
BF	<input type="checkbox"/> OFF	Operating normally
	<input checked="" type="checkbox"/> Red flashing	<ul style="list-style-type: none"> <li>•PROFINET communication is not established.</li> <li>•IP address and device name are duplicated.</li> <li>•The configuration information registered in the master and the profile of the SI unit does not match.</li> </ul>
	<input checked="" type="checkbox"/> Red ON	Both BUS IN and BUS OUT are not linked.
L/A1	<input checked="" type="checkbox"/> Green ON	BUS IN side: Link
	<input type="checkbox"/> Green OFF	BUS IN side: No Link
	<input checked="" type="checkbox"/> Yellow flashing	BUS IN side: Activity
	<input type="checkbox"/> Yellow OFF	BUS IN side: No Activity
L/A2	<input checked="" type="checkbox"/> Green ON	BUS OUT side: Link
	<input type="checkbox"/> Green OFF	BUS OUT side: No Link
	<input checked="" type="checkbox"/> Yellow flashing	BUS OUT side: Activity
	<input type="checkbox"/> Yellow OFF	BUS OUT side: No Activity
PWR	<input checked="" type="checkbox"/> Green ON	SI unit operating voltage is supplied
	<input type="checkbox"/> OFF	SI unit operating voltage is not supplied
PWR(V)	<input checked="" type="checkbox"/> Green ON	Load voltage for the valve is supplied
	<input type="checkbox"/> OFF	Load voltage for the valve is not supplied or is outside the tolerance range (19 V or less)



## ■ Configuration

An applicable GSD file is required to configure the SI unit in the PROFINET network.  
Please download the latest GSD file from the SMC website (URL <http://www.smcworld.com>).

### GSD file

	Model No.	GSD file
1	EX260-SPN1/-SPN2	GSDML-V2.3-SMC-EX260-*****.xml
2	EX260-SPN3/-SPN4	

The network configuration procedure using the SIEMENS STEP7 version V5.5 master software is described below.

### ○ GSD file installation

The GSD file must be installed into the STEP7 system.  
Execute "Options" – "Install GSD File" from the HW Configuration window.

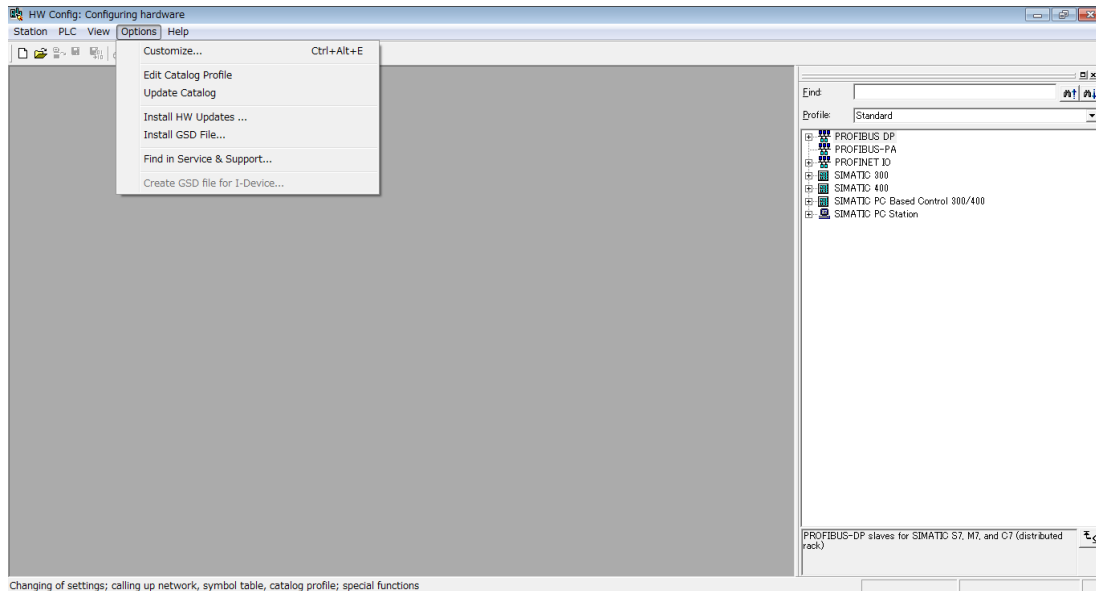

STEP7 software is manufactured by and a registered trademark of Siemens AG.

Browse and select the GSD file stored on the PC.

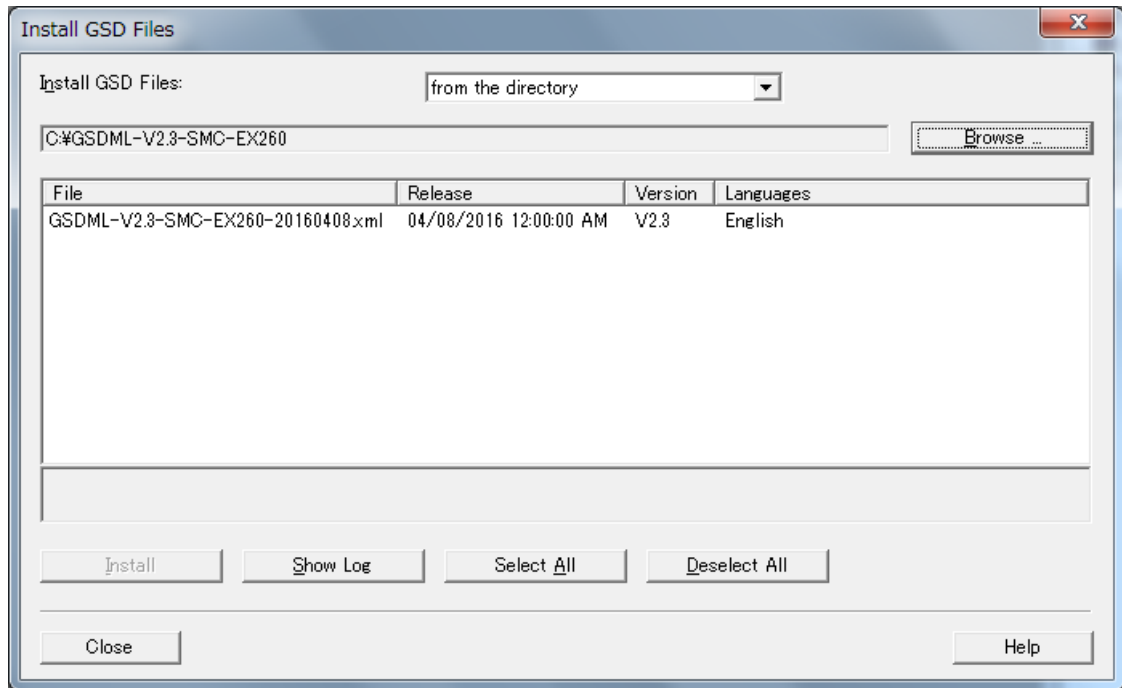

o Device name assignment

Connect the SI unit and execute "PLC" – "Edit Ethernet Node" from the HW Configuration window.

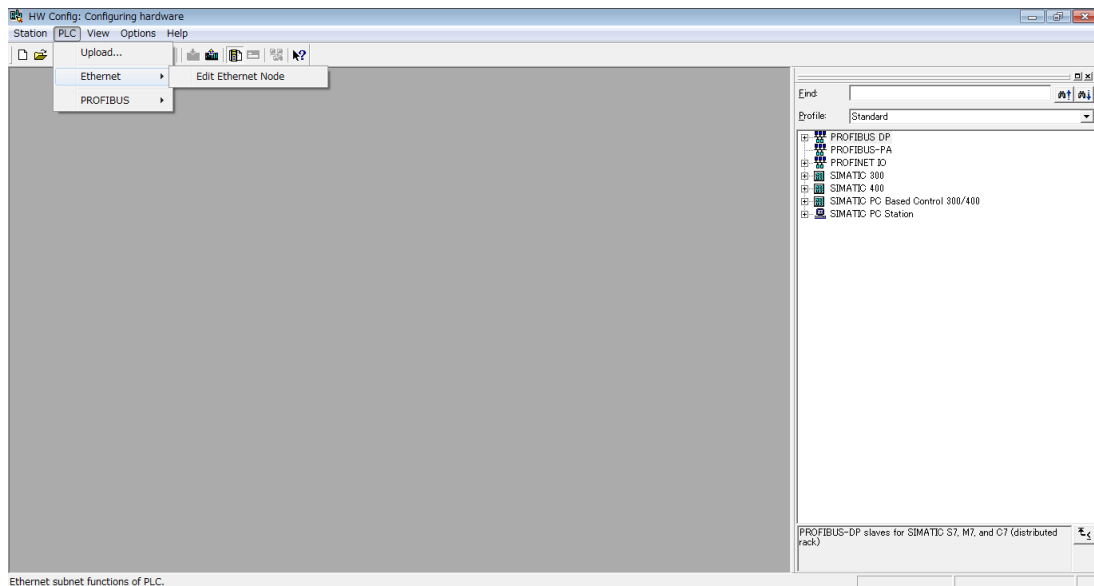

Enter the MAC address if it is known, or execute "Browse" and select the MAC address of the connected SI unit.

After entering the MAC address, assign the Device name.

**Edit Ethernet Node**

Ethernet node

Nodes accessible online

MAC address:

Set IP configuration

Use IP parameters

IP address:  Gateway

Subnet mask:   Do not use router

Obtain IP address from a DHCP server  Use router

Address:

Identified by

Client ID  MAC address  Device name

Client ID:

Assign device name

Device name:

Reset to factory settings

o Remote I/O configuration

Drag and drop the folder for the "EX260-SPN1/2" or "EX260-SPN3/4" from the HW catalogue, and place it on the PROFINET line on the PN master.

- EX260-SPN1/2: SI unit with 32 outputs, EX260-SPN1 or EX260-SPN2  
This SI unit can be used with both firmware version 1.0.0 and 2.1.1 \*1, but the MRP function is not available.
- EX260-SPN1/2 MRP: SI unit with 32 outputs and MRP function, EX260-SPN1 or EX260-SPN2  
This SI unit can be used with firmware version 2.1.1 \*1.  
This SI unit cannot be used with firmware version 1.0.0.
- EX260-SPN3/4: SI unit with 16 outputs, EX260-SPN3 or EX260-SPN4  
This SI unit can be used with both firmware version 1.0.0 and 2.1.1 \*1, but the MRP function is not available.
- EX260-SPN3/4 MRP: SI unit with 16 outputs and MRP function, EX260-SPN3 or EX260-SPN4  
This SI unit can be used with firmware version 2.1.1 \*1.  
This SI unit cannot be used with firmware version 1.0.0.

Select either of the above.

\*1: MRP function is supported in the firmware version released from August 2016 onward (Firmware version 2.1.1).

If the connected SI unit and the selected folder EX260-SPN1/2 or EX260-SPN3/4 do not match, an error will occur due to a mismatch in the number of outputs for slot 1.

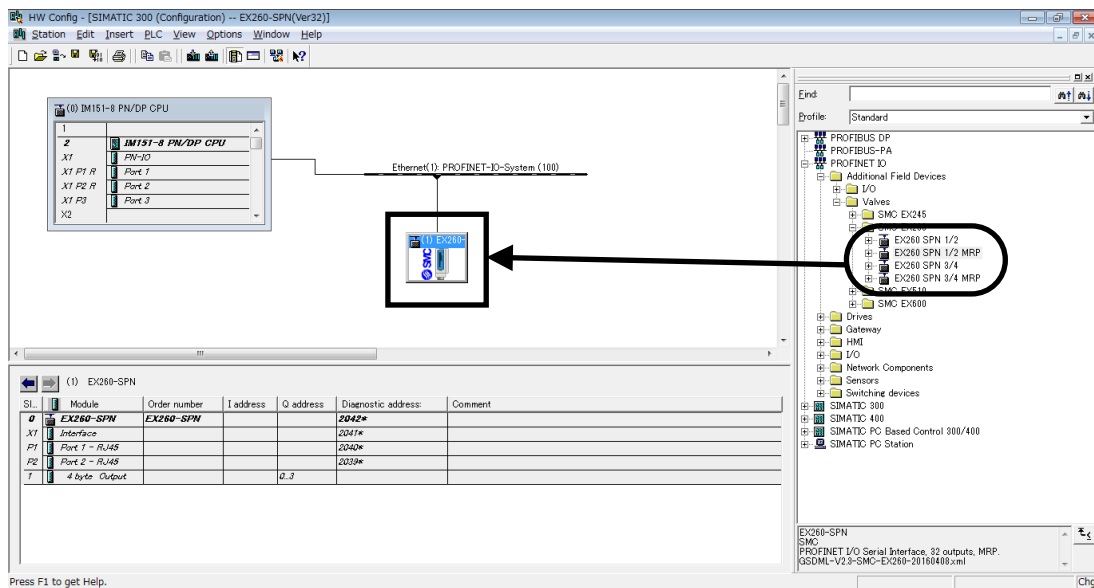

Double click the EX260 icon or right click on the icon and execute "Object property".

Edit the Device name.

"EX260-SPN (EX260-SPN-1, EX260-SPN-2, and so on)" should be entered in the Device name box for each EX260-SPN1/2 or EX260-SPN3/4 set with the hardware configuration.

The same name must be used for the connected SI unit device name (page 18) and the device name set in the hardware configuration. If the device names do not match, the connected SI unit will have a communication failure.

Properties - EX260-SPN

General

Short description: EX260-SPN  
PROFINET I/O Serial Interface, 32 outputs, MRP.

Order no./ firmware: EX260-SPN  
Family: SMC EX260

Device name: EX260-SPN

GSD file: GSDML-V2.3-SMC-EX260-20160408.xml  
Change Release Number...

Node in PROFINET IO system

Device number: 1 PROFINET-IO-System (100)

IP address: 192.168.0.1 Ethernet...

Assign IP address via IO controller

Comment:

OK Cancel Help

○Diagnostic parameters

The diagnostic parameters of the EX260-SPN1/2 (32 outputs) are as follows:

Name	Range of values	Default	Description
Valve Power	Enable Disable	Disable	If the solenoid valve supply voltage is 19 V or less, it is possible to send an error state to the master.
Output 0	Hold Force to ON Force to OFF	Force to OFF	When a bus fault occurs, the output state can be set to either: •Maintain the output state immediately before the bus fault was generated. •Force the output ON •Force the output OFF
Output 1	Hold Force to ON Force to OFF	Force to OFF	
:	:	:	
Output31	Hold Force to ON Force to OFF	Force to OFF	

The diagnostic parameters of the EX260-SPN3/4 (16 outputs) are as follows:

Name	Range of values	Default	Description
Valve Power	Enable Disable	Disable	If the solenoid valve supply voltage is 19 V or less, it is possible to send an error state to the master.
Output 0	Hold Force to ON Force to OFF	Force to OFF	When a bus fault occurs, the output state can be set to either: •Maintain the output state immediately before the bus fault was generated. •Force the output ON •Force the output OFF
Output 1	Hold Force to ON Force to OFF	Force to OFF	
:	:	:	
Output15	Hold Force to ON Force to OFF	Force to OFF	

○Diagnostics information

Channel Error Type

Value (hexadecimal)	Description	Error message
W#16#0011	Vendor-specific Power supply failure	Power supply failure



oFSU (Fast Start Up) function

The EX260-SPN supports the FSU function.

The connected master controller must also support the FSU function in order to enable the EX260-SPN FSU function.

•Configuration of the controller to enable the FSU function

Double click the PROFINET port of the controller which is connected to the EX260-SPN to enable the FSU function.

Select "Options" – "TP/ITP 100 Mbps full duplex"and check "Disable autonegotiation".

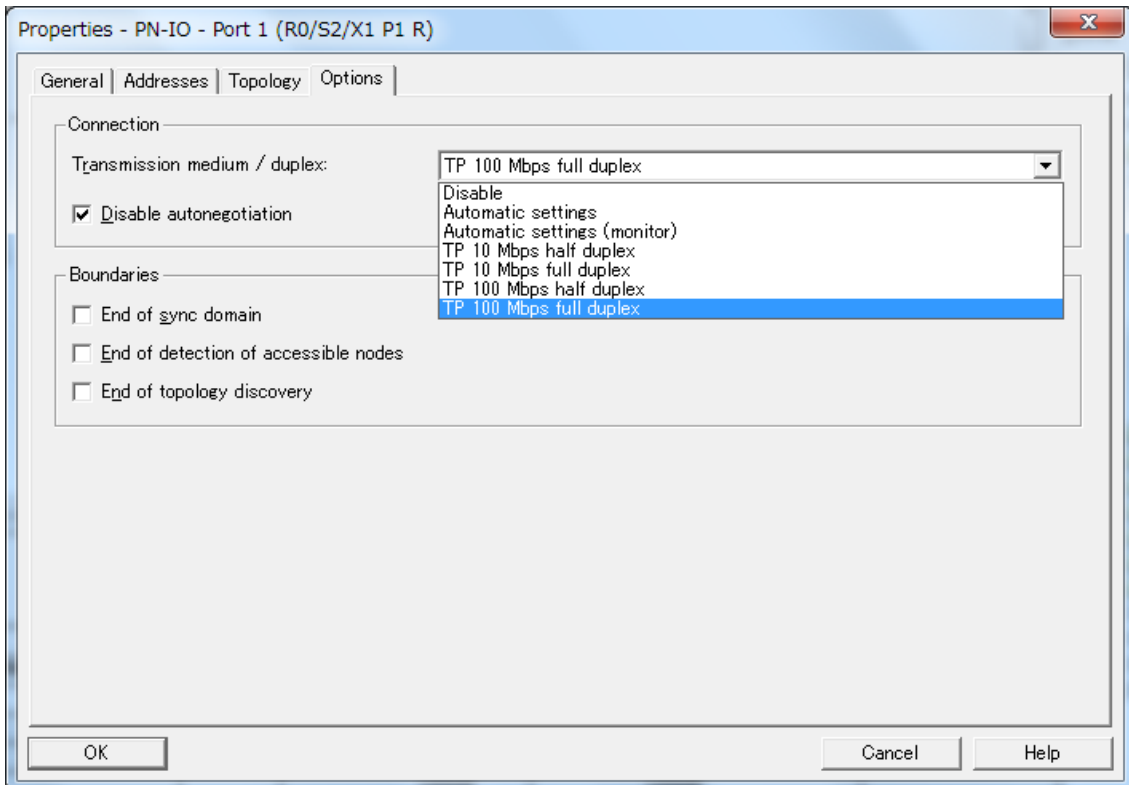



•Configuration of the EX260-SPN to enable the FSU function

Select the EX260-SPN icon from the dialogue of the HW configuration window.

Double click the Slot X1 Interface and in the "General" window check "Prioritized startup".

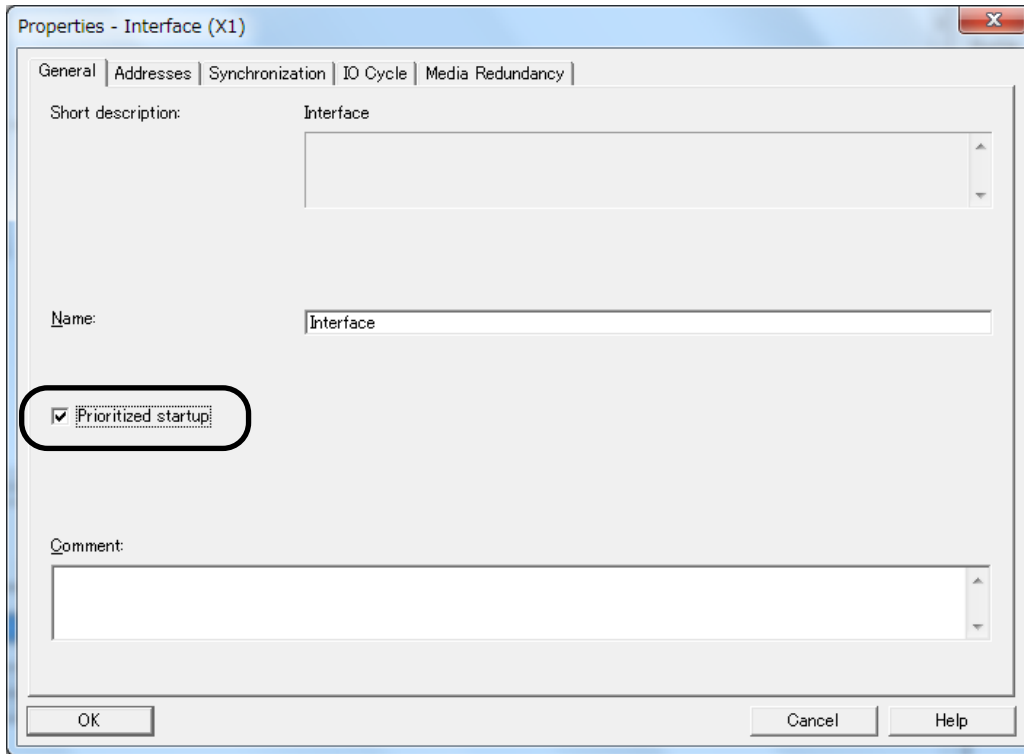

Double click the port (P1 (BUS IN) or P2 (BUS OUT)) which enables the EX260-SPN FSU function. Select "Options" – "TP/ITP 100 Mbps full duplex" and check "Disable autonegotiation".

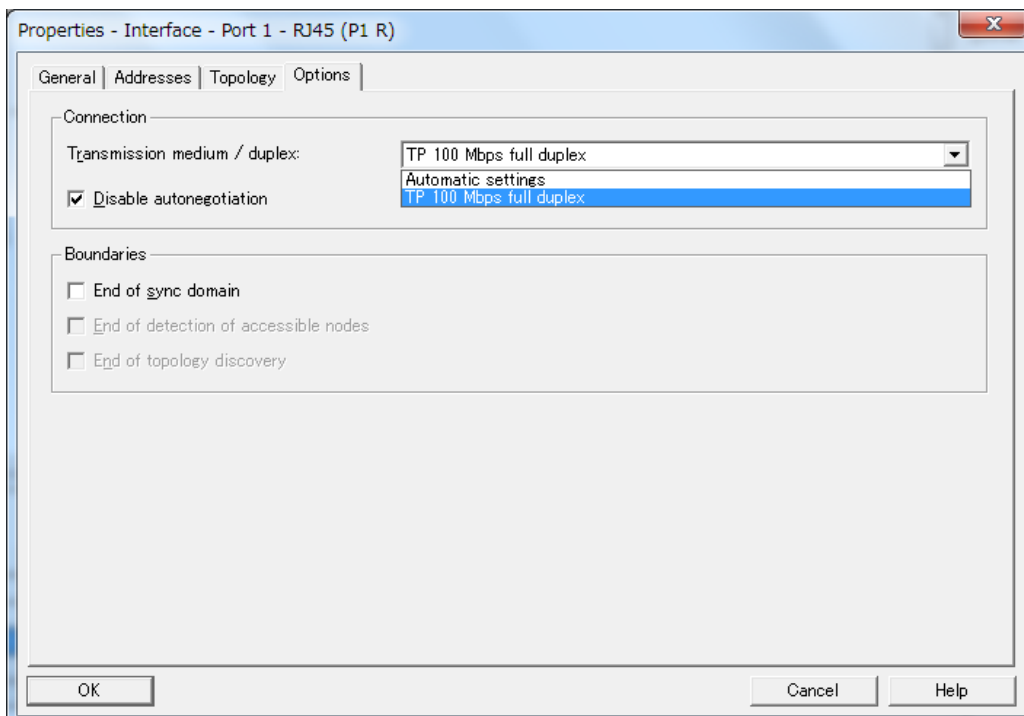

○Output number assignment  
Output data

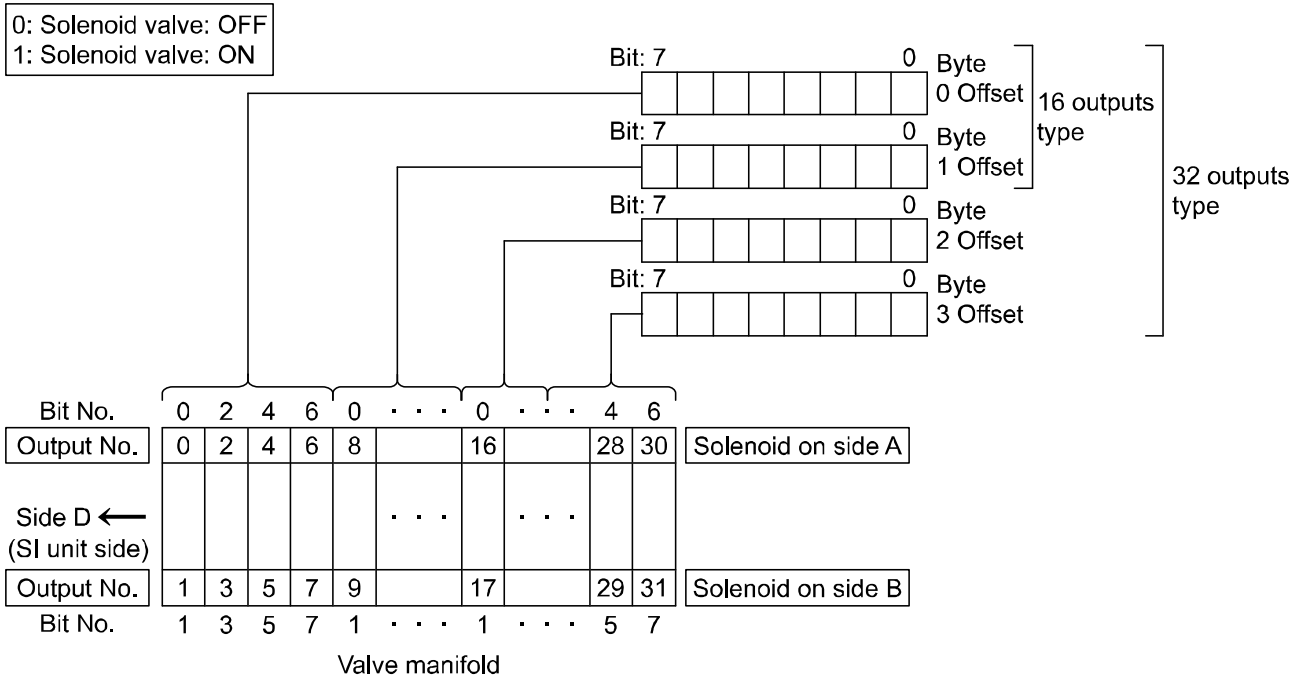

- \*: The output numbering refers to the solenoid position on the manifold and starts at zero.
- \*: Standard wiring of the manifold is for double-solenoid valves and the output number starts at the A side and then B side in that order as shown in the figure a.  
If a single-solenoid valve is mounted on the standard wiring manifold, the output number for the B side valve is skipped.
- \*: Custom wiring for mixed mounting single-solenoid valves and double-solenoid-valves can be specified with a Wiring Specification Sheet. Example wiring is shown in the figure b.
- \*: Bit status "0" and "1" in the data corresponds to solenoid valve status OFF and ON (0: OFF, 1: ON), and the output number starts at zero from LSB (least significant bit).

fig.a

	No.	Station	No.
Double	4	3	5
Single	2	2	3 free
Double	0	1	1

fig.b

	No.	Station	No.
Double	3	3	4
Single	2	2	-
Double	0	1	1

# Troubleshooting and Maintenance

## ○ Troubleshooting chart

When any malfunction is observed, it is recommended to perform the following troubleshooting.

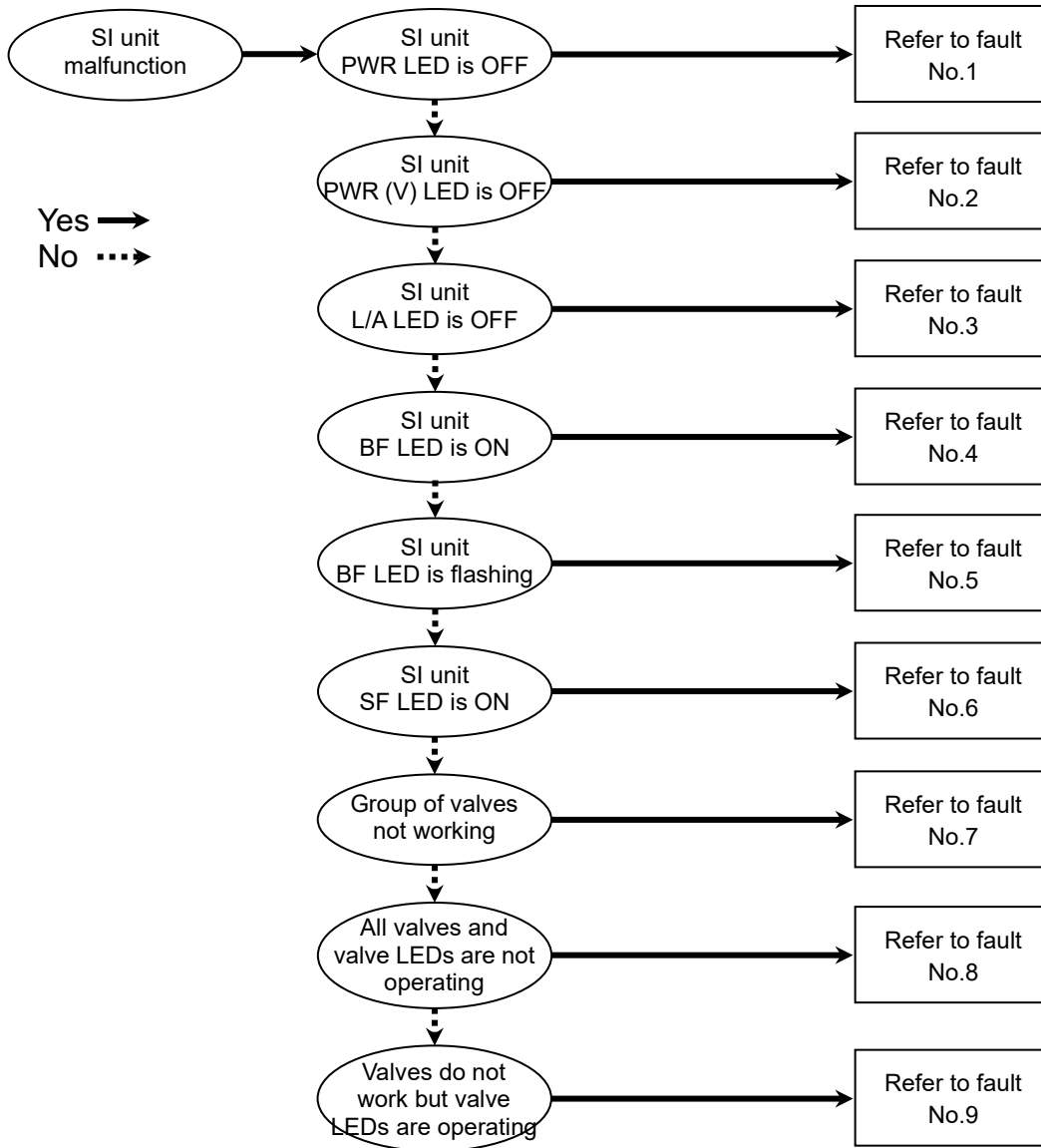

## Troubleshooting table

### Fault No.1

Fault	Probable cause	Recommended error handling	Recommended action
SI unit PWR LED is OFF	Defective power cable wiring for SI unit operation	Check the condition of the power cable wiring to the SI unit.	Re-tighten the power cable. (Replace the cable if it is broken)
	SI unit operating voltage is not supplied	Check the condition of the supply voltage to the SI unit.	Correct the power cable wiring layout.  Supply 24 VDC $\pm$ 10% to the SI unit.

### Fault No.2

Fault	Probable cause	Recommended error handling	Recommended action
SI unit PWR (V) LED is OFF	Defective power cable wiring for the solenoid valve	Check the condition of the power cable wiring for the valve.	Re-tighten the power cable. (Replace the cable if it is broken)
	Load voltage for the valve is not supplied	Check the condition of the supply voltage for the valve.	Correct the power cable wiring layout.  Supply 24 VDC +10%/-5% to the valves.

### Fault No.3

Fault	Probable cause	Recommended error handling	Recommended action
SI unit L/A LED is OFF	PROFINET communication error between the SI unit and the upstream PROFINET device.	Check the condition of the upstream PROFINET device.	Supply power to the upstream PROFINET device.
		Check the BUS IN side communication cable connections and check for broken wires.	Tighten the communication cable connection. (Replace the cable if it is broken)
		Check that there are no high voltage cables or equipment that generates noise around the communication cable and SI unit.	Take measures to keep the communication cable and SI unit away from noise sources.

### Fault No. 4

Fault	Possible cause	Investigation method	Countermeasures
SI unit BF LED is ON red	No Link on Port1 and Port2	Check the communication cable connections and check for broken wires.	Tighten the communication cable connection. (if there is a broken wire, replace the cable)
		Check that there is no high voltage cable or equipment that generates noise around the communication cable and SI unit.	Take measures to keep the communication cable and SI unit away from noise sources.

Fault No.5

Fault	Probable cause	Recommended error handling	Recommended action
SI unit BF LED is flashing	PROFINET communication is abnormal (Bus Fault).	Check the communication cable connections and check for broken wires.	Tighten the communication cable connection. (Replace the cable if it is broken)
		Check that the configuration information registered in the PN master matches the profile of the SI unit.	Configure the SI unit in the PN master software.
		Check that the IP address and Device name of the SI unit are not duplicated.	Configure the SI unit in the PN master software.
		Check that there is no high voltage cable or equipment that generates noise around the communication cable and SI unit.	Take measures to keep the communication cable and SI unit away from noise sources.

Fault No.6

Fault	Probable cause	Recommended error handling	Recommended action
SI unit SF LED is ON	Diagnostic error	Check that the diagnostic parameter for Valve Power is "Enabled" and that the solenoid valve power is supplied.	Supply 24 VDC +10%/-5% to the valves.
	Configuration error	The configuration information registered in the master and the number of output points do not match.	Check the PLC configuration setting.

Fault No.7

Fault	Probable cause	Recommended error handling	Recommended action
Group of valves not working	Too many valves	<p>Check if solenoid count does not exceed the allowable number. This depends on the SI unit model and valve series.</p> <p>Allowable solenoid number by valve series:            SY/SV/S0700 series: 32 points            VQC series: 24 points</p>	Keep the number of mounted solenoid valves within specification.

Fault No.8

Fault	Probable cause	Recommended error handling	Recommended action
All valves and valve LEDs are not operating	Poor connection between SI unit and valve manifold	Check if there are any loose screws making the connection between the SI unit and the valve manifold.	Tighten the screws with the specified tightening torque (i.e. 0.6 N•m) and make sure there is no gap between the SI unit and the valve manifold.
	Mismatch polarity between solenoid valve and SI unit output	Check if the solenoid valve common specification matches the output polarity of the SI unit.	Match polarity between solenoid valve and SI unit output.
	Defective solenoid valve	Follow the troubleshooting for the solenoid valve.	Same as left.

Fault No.9

Fault	Probable cause	Recommended error handling	Recommended action
Valves do not work but valve LEDs are operating	Mismatch polarity between solenoid valve and SI unit output	Check if the solenoid valve common specification matches the output polarity of the SI unit.	Match polarity between solenoid valve and SI unit output.

○Maintenance

Replacement of the SI unit

- Remove the M3 hexagon screws from the SI unit and release the SI unit from the valve manifold.
- Replace the SI unit.
- Tighten the screws with the specified tightening torque. (0.6 N•m)

Precautions for maintenance

- (1) Be sure to switch off the power.
- (2) Check there is no foreign matter inside the SI unit.
- (3) Check there is no damage and no foreign matter on the gasket.
- (4) Be sure to tighten the screws with the specified torque.

If the SI unit is not assembled properly, inside PCBs may be damaged or liquid and/or dust may enter into the unit.

○Assembly and disassembly of the SI unit

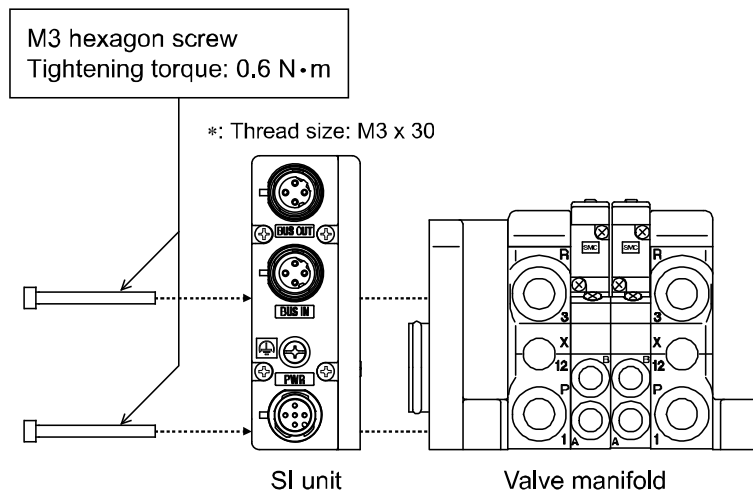

# Specifications

## ■ Specifications

### General specifications

Item	Specifications
Ambient temperature	-10 to +50 °C
Ambient humidity	35 to 85%RH (No condensate)
Ambient temperature for storage	-20 to +60 °C
Withstand voltage	500 VAC applied for 1 minute
Insulation resistance	500 VDC, 10 MΩ or more
Operating atmosphere	No corrosive gas
Enclosure	IP67
Weight	200 g or less
Standard	UL/CSA, CE/UKCA marked

### Electrical specifications

Item		Specifications	
Current consumption in power supply voltage range	Current consumption of controller power supply	21.6 to 26.4 VDC 0.1 A max.	
	Solenoid valve power supply	22.8 to 26.4 VDC 2.0 A or less, according to the solenoid valve station specification	
Solenoid valve connecting specification	Output type	EX260-SPN1/-SPN3	PNP (negative common) / source
		EX260-SPN2/-SPN4	NPN (positive common) / sink
	Connected load	Solenoid valve with surge voltage suppressor of 24 VDC and 1.0 W or less (manufactured by SMC)	
	Insulation type	Photo coupler insulation type	
	Residual voltage	0.4 VDC or less	

### Network communication specifications

Item		Specifications
Protocol		PROFINET IO (PROFINET RT)
Transmission medium		Standard Ethernet cable (CAT5 or more) (100BASE-TX)
Transmission speed		100 Mbps
Number of outputs	EX260-SPN1/-SPN2	32 outputs
	EX260-SPN3/-SPN4	16 outputs
Vendor ID		0083 hex
Device ID		0001 hex
Conformance class		Class C(Only for IRT switch function) *1
Applicable function		FSU (Fast Start Up) MRP (Media Redundancy Protocol) *1

\*1: The MRP function is supported in the firmware version released from August 2016 onward (Firmware version 2.1.1).



### Connectable valve series

Valve Series	
SY series	SY3000, SY5000
VQC series	VQC1000, VQC2000, VQC4000
SV series	SV1000, SV2000, SV3000 (10 type tie-rod base)
S0700 series	S0700

\*: The valve manifolds that can be connected are the same as those connectable to EX250 series.

## ■Dimensions

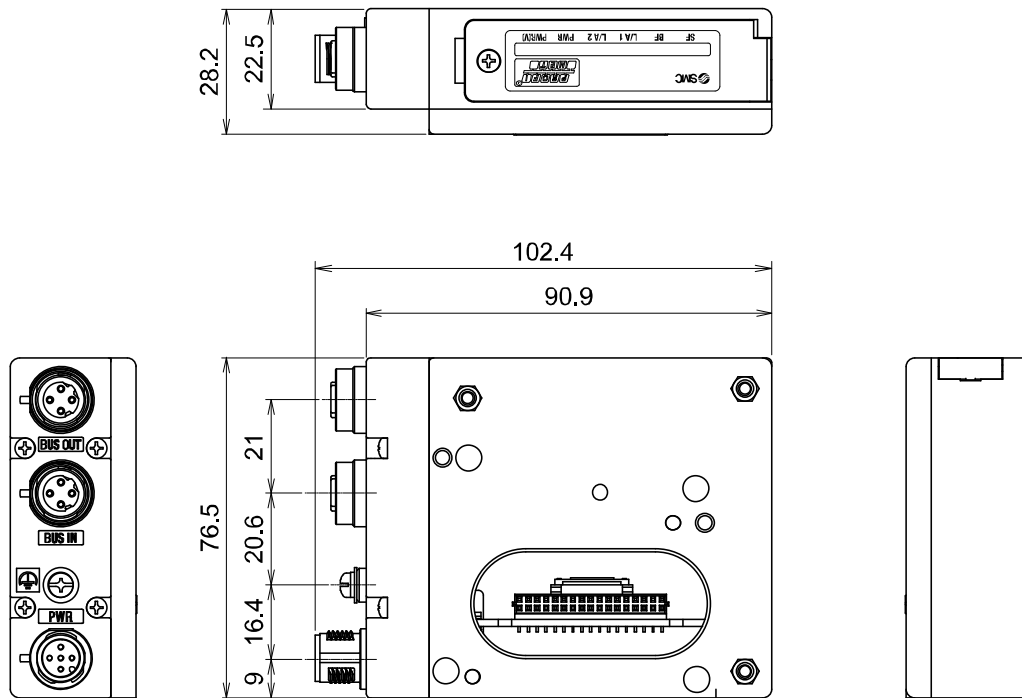

- If a fieldwireable connector is used for the power supply connection, and the SI unit is installed directly to a valve manifold, the cable connector's outer diameter should be  $\phi 16$  mm or less. If it is a larger diameter, the connector will interfere with the mounting surface. Recommended cables are specified in the accessories section, on page 34.

## Accessories

### Fieldbus interface connector

#### (1) Cable with communication connector (SPEEDCON)

Part number: PCA-1446566

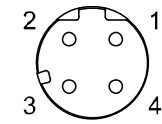

Plug connector  
pin assignment  
D-coded

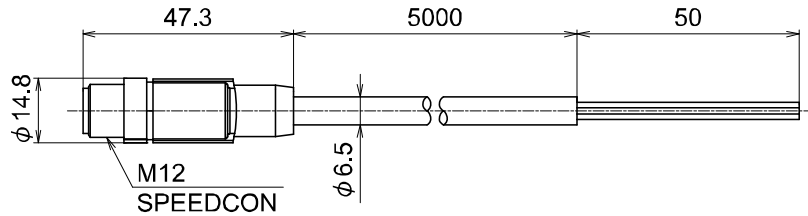

Item	Specifications
Connector	M12 Straight (SPEEDCON)
Cable length	5000 mm
Cable O.D.	$\phi 6.5$ mm
Nominal cross section	AWG22
Wire diameter (Including insulator)	1.5 mm
Min. bending radius (Fixed)	19.5 mm

Pin No.	Cable colour: Signal
1	Yellow : TD+
2	White : RD+
3	Orange: TD-
4	Blue : RD-

#### (2) Fieldwireable connector

Part number: PCA-1446553

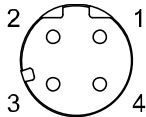

Plug connector  
pin assignment  
D-coded

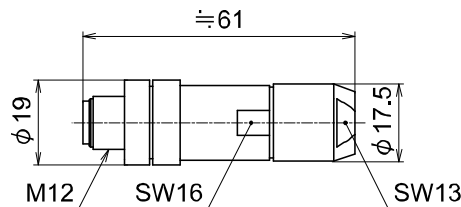

#### Applicable cable

Item	Specifications
Cable O.D.	$\phi 4.0$ to $8.0$ mm
Electric wire cross section (Twist line)	AWG26 to 22

Pin No.	Colour on the feed holes	Cable colour	Signal
1	Orange/ White	YE=Yellow or OGWH=Orange/ White	TD+
2	Green/ White	WH=White or GNWH=Green/ White	RD+
3	Orange	OG=Orange	TD-
4	Green	BU=Blue or GN=Green	RD-

(3) Cable with communication connector

Part number: EX9-AC010EN-PSRJ

● Cable length (L)

01	1000 [mm]
02	2000 [mm]
03	3000 [mm]
05	5000 [mm]
10	10000 [mm]

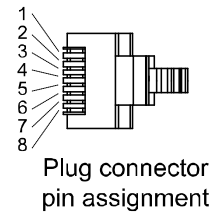
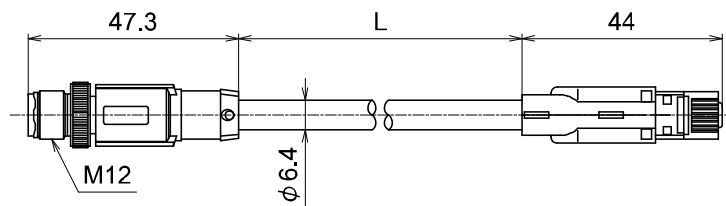
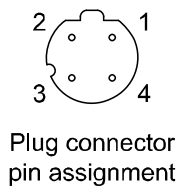

Item	Specifications
Connector	M12 Straight ↔ RJ45
Cable O.D.	φ6.4 mm
Nominal cross section	AWG26
Min. bending radius (Fixed)	26 mm

(4) Seal cap

Part number: EX9-AWTS

This cap is used to protect the M12 connector opening when the connector is not used. When the "BUS OUT" connector is not used, the seal cap can keep the SI unit under IP67 rated protection.

(One seal cap will be attached to the SI unit when shipped from factory.)

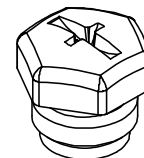

Description	Part No.	Specification
Seal cap	EX9-AWTS	For M12 connector socket: 10 pcs.

- Power supply connector
- (1) Cable with power supply connector

Part number: EX500-AP010-S

Connector specifications

S	Straight
A	Angle

Cable length (L)

1	1000 [mm]
5	5000 [mm]

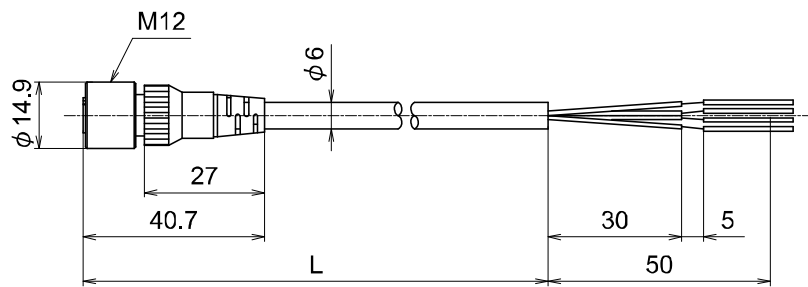

EX500-AP0#0-S

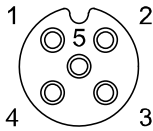

Socket connector  
pin assignment  
A-coded (Normal key)

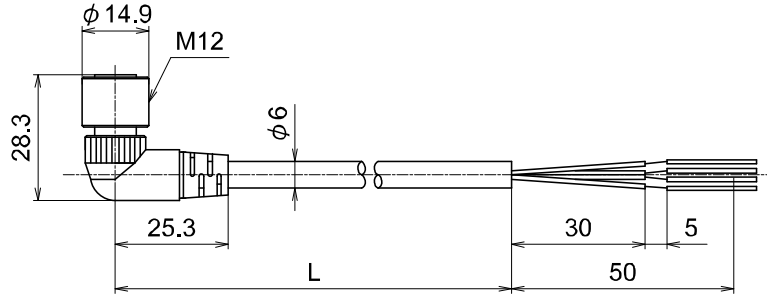

EX500-AP0#0-A

Item	Specifications
Cable O.D.	φ6 mm
Nominal cross section	AWG22
Wire diameter (Including insulator)	1.5 mm
Min. bending radius (Fixed)	40 mm

Pin No.	Cable colour: Signal
1	Brown: 24 VDC (For solenoid valve)
2	White : 0 V (For solenoid valve)
3	Blue : 24 VDC (For control)
4	Black : 0 V (For control)
5	Gray : Not connected

(2) Cable with power supply connector (SPEEDCON)

Part number: PCA-1401804

• Cable length (L)

4	1500 [mm]
5	3000 [mm]
6	5000 [mm]

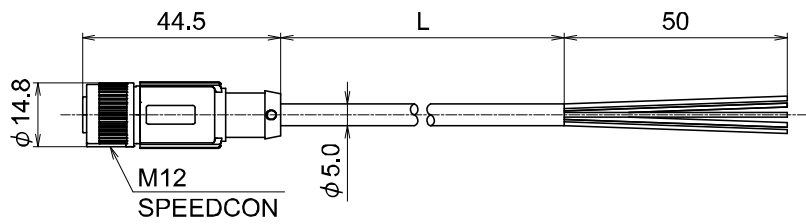
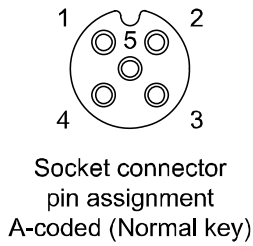

Item	Specifications
Connector	M12 Straight (SPEEDCON)
Cable O.D.	φ5 mm
Nominal cross section	AWG22
Wire diameter (Including insulator)	1.27 mm
Min. bending radius (Fixed)	21.7 mm

Pin No.	Cable colour: Signal
1	Brown: 24 VDC (For solenoid valve)
2	White : 0 V (For solenoid valve)
3	Blue : 24 VDC (For control)
4	Black : 0 V (For control)
5	Green/Yellow: Not connected

#### Revision history

A: Revision  
B: Revision  
C: Addition of specification Version 2.3.  
[September 2016]  
D: Contents revised in several places.  
[April 2017]  
E: Contents revised in several places. [June 2022]  
F: Contents revised in several places [May 2024]

## SMC Corporation

Tel: + 81 3 5207 8249 Fax: +81 3 5298 5362

URL <https://www.smcworld.com>

---

Note: Specifications are subject to change without prior notice and any obligation on the part of the manufacturer.  
© SMC Corporation All Rights Reserved

