



Operation Manual

PRODUCT NAME

SI unit for PROFIBUS DP

MODEL / Series / Product Number

EX260 Series

SMC Corporation

Table of Contents

Safety Instructions	2
Model Indication and How to Order	8
Summary of Product elements	9
Installation and Wiring	11
Installation	11
Wiring	12
LED Indication and Settings	17
Troubleshooting and Maintenance	25
Specifications	29
Specifications	29
Dimensions	31
Accessories	32



Safety Instructions

These safety instructions are intended to prevent hazardous situations and/or equipment damage. These instructions indicate the level of potential hazard with the labels of “**Caution**,” “**Warning**” or “**Danger**.” They are all important notes for safety and must be followed in addition to International Standards (ISO/IEC)^{*1)}, and other safety regulations.

*1) ISO 4414: Pneumatic fluid power - General rules and safety requirements for systems and their components
ISO 4413: Hydraulic fluid power - General rules and safety requirements for systems and their components
IEC 60204-1: Safety of machinery - Electrical equipment of machines - Part 1: General requirements
ISO 10218-1: Robots and robotic devices - Safety requirements for industrial robots - Part 1: Robots
etc.



Danger

Danger indicates a hazard with a high level of risk which, if not avoided, will result in death or serious injury.



Warning

Warning indicates a hazard with a medium level of risk which, if not avoided, could result in death or serious injury.



Caution

Caution indicates a hazard with a low level of risk which, if not avoided, could result in minor or moderate injury.

Warning

1. The compatibility of the product is the responsibility of the person who designs the equipment or decides its specifications.

Since the product specified here is used under various operating conditions, its compatibility with specific equipment must be decided by the person who designs the equipment or decides its specifications based on necessary analysis and test results. The expected performance and safety assurance of the equipment will be the responsibility of the person who has determined its compatibility with the product. This person should also continuously review all specifications of the product referring to its latest catalog information, with a view to giving due consideration to any possibility of equipment failure when configuring the equipment.

2. Only personnel with appropriate training should operate machinery and equipment.

The product specified here may become unsafe if handled incorrectly. The assembly, operation and maintenance of machines or equipment including our products must be performed by an operator who is appropriately trained and experienced.

3. Do not service or attempt to remove product and machinery/equipment until safety is confirmed.

1. The inspection and maintenance of machinery/equipment should only be performed after measures to prevent falling or runaway of the driven objects have been confirmed.
2. When the product is to be removed, confirm that the safety measures as mentioned above are implemented and the power from any appropriate source is cut, and read and understand the specific product precautions of all relevant products carefully.
3. Before machinery/equipment is restarted, take measures to prevent unexpected operation and malfunction.

4. Our products cannot be used beyond their specifications. Our products are not developed, designed, and manufactured to be used under the following conditions or environments. Use under such conditions or environments is not covered.

1. Conditions and environments outside of the given specifications, or use outdoors or in a place exposed to direct sunlight.
2. Use for nuclear power, railways, aviation, space equipment, ships, vehicles, military application, equipment affecting human life, body, and property, fuel equipment, entertainment equipment, emergency shut-off circuits, press clutches, brake circuits, safety equipment, etc., and use for applications that do not conform to standard specifications such as catalogs and operation manuals.
3. Use for interlock circuits, except for use with double interlock such as installing a mechanical protection function in case of failure. Please periodically inspect the product to confirm that the product is operating properly.



Safety Instructions

Caution

We develop, design, and manufacture our products to be used for automatic control equipment, and provide them for peaceful use in manufacturing industries.

Use in non-manufacturing industries is not covered.

Products we manufacture and sell cannot be used for the purpose of transactions or certification specified in the Measurement Act.

The new Measurement Act prohibits use of any unit other than SI units in Japan.

Limited warranty and Disclaimer/Compliance Requirements

The product used is subject to the following “Limited warranty and Disclaimer” and “Compliance Requirements”.

Read and accept them before using the product.

Limited warranty and Disclaimer

1. The warranty period of the product is 1 year in service or 1.5 years after the product is delivered, whichever is first.*2)
Also, the product may have specified durability, running distance or replacement parts. Please consult your nearest sales branch.
2. For any failure or damage reported within the warranty period which is clearly our responsibility, a replacement product or necessary parts will be provided.
This limited warranty applies only to our product independently, and not to any other damage incurred due to the failure of the product.
3. Prior to using SMC products, please read and understand the warranty terms and disclaimers noted in the specified catalog for the particular products.

***2) Vacuum pads are excluded from this 1 year warranty.**

A vacuum pad is a consumable part, so it is warranted for a year after it is delivered.

Also, even within the warranty period, the wear of a product due to the use of the vacuum pad or failure due to the deterioration of rubber material are not covered by the limited warranty

Compliance Requirements

1. The use of SMC products with production equipment for the manufacture of weapons of mass destruction (WMD) or any other weapon is strictly prohibited.
2. The exports of SMC products or technology from one country to another are governed by the relevant security laws and regulations of the countries involved in the transaction. Prior to the shipment of a SMC product to another country, assure that all local rules governing that export are known and followed.

Operator

- ◆ This operation manual is intended for those who have knowledge of machinery using pneumatic equipment, and have sufficient knowledge of assembly, operation and maintenance of such equipment. Only those persons are allowed to perform assembly, operation and maintenance.
- ◆ Read and understand this operation manual carefully before assembling, operating or providing maintenance to the product.

■ Safety Instructions

Warning

- Do not disassemble, modify (including changing the printed circuit board) or repair.
An injury or failure can result.
- Do not operate the product outside of the specifications.
Do not use for flammable or harmful fluids.
Fire, malfunction, or damage to the product can result.
Verify the specifications before use.
- Do not operate in an atmosphere containing flammable or explosive gases.
Fire or an explosion can result.
This product is not designed to be explosion proof.
- If using the product in an interlocking circuit:
 - Provide a double interlocking system, for example a mechanical system.
 - Check the product regularly for proper operation.Otherwise malfunction can result, causing an accident.
- The following instructions must be followed during maintenance:
 - Turn off the power supply.
 - Stop the air supply, exhaust the residual pressure and verify that the air is released before performing maintenance.Otherwise an injury can result.

Caution

- After maintenance is complete, perform appropriate functional inspections.
Stop operation if the equipment does not function properly.
Safety cannot be assured in the case of unexpected malfunction.
- Provide grounding to assure the noise resistance of the Serial System.
Individual grounding should be provided close to the product with a short cable.

■NOTE

- Follow the instructions given below when designing, selecting and handling the product.
- The instructions on design and selection (installation, wiring, environment, adjustment, operation, maintenance, etc.) described below must also be followed.
 - *Product specifications
 - When conformity to UL is required, the SI unit should be used with a UL1310 Class 2 power supply.
 - The SI unit is a UL approved product only if they have a  mark on the body.
 - Use the specified voltage.
Otherwise failure or malfunction can result.
 - Reserve a space for maintenance.
Allow sufficient space for maintenance when designing the system.
 - Do not remove any nameplates or labels.
This can lead to incorrect maintenance, or misreading of the operation manual, which could cause damage or malfunction to the product.
It may also result in non-conformity to safety standards.

●Product handling

*Installation

- Do not drop, hit or apply excessive shock to the fieldbus system.
Otherwise damage to the product can result, causing malfunction.
- Tighten to the specified tightening torque.
If the tightening torque is exceeded the mounting screws may be broken.
IP67 protection cannot be guaranteed if the screws are not tightened to the specified torque.
- Never mount a product in a location that will be used as a foothold.
The product may be damaged if excessive force is applied by stepping or climbing onto it.

*Wiring

- Avoid repeatedly bending or stretching the cables, or placing heavy load on them.
Repetitive bending stress or tensile stress can cause breakage of the cable.
- Wire correctly.
Incorrect wiring can break the product.
- Do not perform wiring while the power is on.
Otherwise damage to the fieldbus system and/or I/O device can result, causing malfunction.
- Do not route wires and cables together with power or high voltage cables.
Otherwise the fieldbus system and/or I/O device can malfunction due to interference of noise and surge voltage from power and high voltage cables to the signal line.
Route the wires (piping) of the fieldbus system and/or I/O device separately from power or high voltage cables.
- Confirm proper insulation of wiring.
Poor insulation (interference from another circuit, poor insulation between terminals, etc.) can lead to excess voltage or current being applied to the product, causing damage.
- Take appropriate measures against noise, such as using a noise filter, when the fieldbus system is incorporated into equipment.
Otherwise noise can cause malfunction.

*Environment

- Select the proper type of protection according to the environment of operation.
IP67 protection is achieved when the following conditions are met.
 - (1) The units are connected properly with fieldbus cable with M12 connector and power cable with M12 (M8) connector.
 - (2) Suitable mounting of each unit and manifold valve.

If using in an environment that is exposed to water splashes, please take measures such as using a cover.
- Do not use in a place where the product could be splashed by oil or chemicals.
If the product is to be used in an environment containing oils or chemicals such as coolant or cleaning solvent, even for a short time, it may be adversely affected (damage, malfunction etc.).
- Do not use the product in an environment where corrosive gases or fluids could be splashed.
Otherwise damage to the product and malfunction can result.
- Do not use in an area where surges are generated.
If there is equipment which generates a large amount of surge (solenoid type lifter, high frequency induction furnace, motor, etc.) close to the fieldbus system, this may cause deterioration or breakage of the internal circuit of the fieldbus system. Avoid sources of surge generation and crossed lines.
- When a surge-generating load such as a relay or solenoid is driven directly, use an fieldbus system with a built-in surge absorbing element.
Direct drive of a load generating surge voltage can damage the fieldbus system.
- The product is CE/UKCA marked, but not immune to lightning strikes. Take measures against lightning strikes in the system.
- Prevent foreign matter such as remnant of wires from entering the fieldbus system to avoid failure and malfunction.

- Mount the product in a place that is not exposed to excessive vibration or impact.
Otherwise failure or malfunction can result.
- Do not use the product in an environment that is exposed to temperature cycle.
Heat cycles other than ordinary changes in temperature can adversely affect the inside of the product.
- Do not expose the product to direct sunlight.
If using in a location directly exposed to sunlight, shade the product from the sunlight.
Otherwise failure or malfunction can result.
- Keep within the specified ambient temperature range.
Otherwise malfunction can result.
- Do not operate close to a heat source, or in a location exposed to radiant heat.
Otherwise malfunction can result.

*Adjustment and Operation

- Set the switches by using a sharp-pointed screwdriver etc.
It may damage set switches.
- Perform settings suitable for the operating conditions.
Incorrect setting can cause operation failure.
For details of each setting, refer to page 18 to 20 of this manual.
- Please refer to the PLC manufacturer's manual etc. for details of programming and addresses.
For the PLC protocol and programming refer to the relevant manufacturer's documentation.

*Maintenance

- Turn off the power supply, stop the supplied air, exhaust the residual pressure and verify the release of air before performing maintenance.
There is a risk of unexpected malfunction.
- Perform regular maintenance and inspections.
There is a risk of unexpected malfunction.
- After maintenance is complete, perform appropriate functional inspections.
Stop operation if the equipment does not function properly.
Otherwise safety is not assured due to an unexpected malfunction or incorrect operation.
- Do not use solvents such as benzene, thinner etc. to clean the each unit.
They could damage the surface of the body and erase the markings on the body.
Use a soft cloth to remove stains.
For heavy stains, use a cloth soaked with diluted neutral detergent and fully squeezed, then wipe up the stains again with a dry cloth.

Model Indication and How to Order

EX260-SPR 1

- Connector type, output specification

1	M12 connector, 32 outputs, PNP (negative common) / source
2	M12 connector, 32 outputs, NPN (positive common) / sink
3	M12 connector, 16 outputs, PNP (negative common) / source
4	M12 connector, 16 outputs, NPN (positive common) / sink
5	D-sub connector, 32 outputs, PNP (negative common) / source
6	D-sub connector, 32 outputs, NPN (positive common) / sink
7	D-sub connector, 16 outputs, PNP (negative common) / source
8	D-sub connector, 16 outputs, NPN (positive common) / sink

- Fieldbus

PR	PROFIBUS DP
----	-------------

Summary of Product elements

<EX260-SPR1/-SPR2/-SPR3/-SPR4>

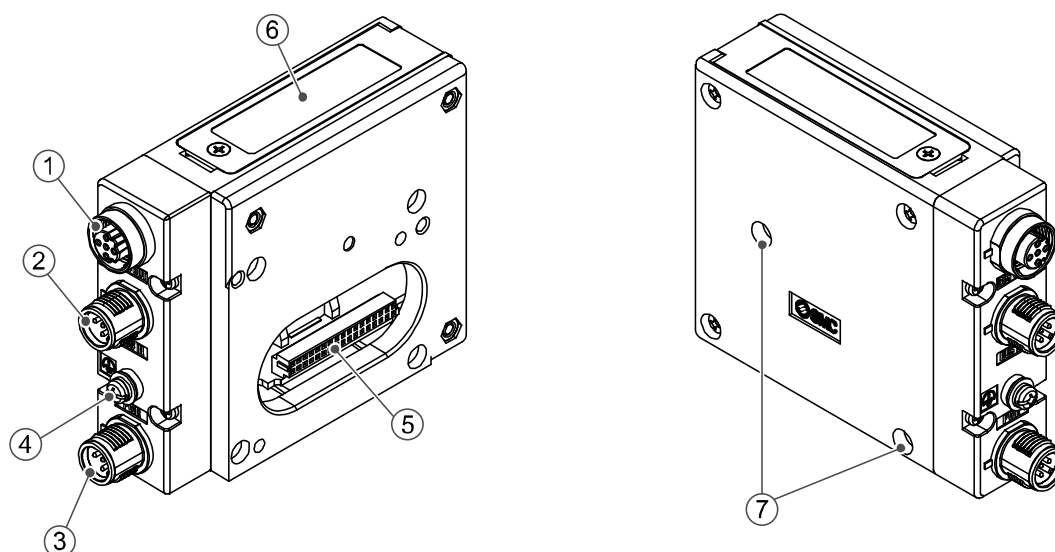

No.	Element	Description
1	Fieldbus interface connector (BUS OUT)	PROFIBUS DP connection. *1 (M12 5-pin socket, B-coded)
2	Fieldbus interface connector (BUS IN)	PROFIBUS DP connection. *1 (M12 5-pin plug, B-coded)
3	Power supply connector	Power supply with load voltage for valves and operating voltage for SI unit. *1 (M12 5-pin plug, A-coded)
4	FE terminal	Functional earth. (M3 screw)
5	Output connector	Output signal interface for valve manifold.
6	LED and switch	LED display to indicate the status of the SI unit. *2 Switches for setting of node address and operating mode. *2
7	Mounting hole	Mounting hole for connection to the valve manifold.

Accessories

Hexagon socket head cap screw	2 pcs. M3 x 30 screw for connection to the valve manifold.
Seal cap	1 pc. seal cap for unused fieldbus interface connector (BUS OUT).

*1: For details of suitable cables refer to the Accessories section on page 32.

*2: Refer to page 17 for the LED Indication and Settings.

<EX260-SPR5/-SPR6/-SPR7/-SPR8>

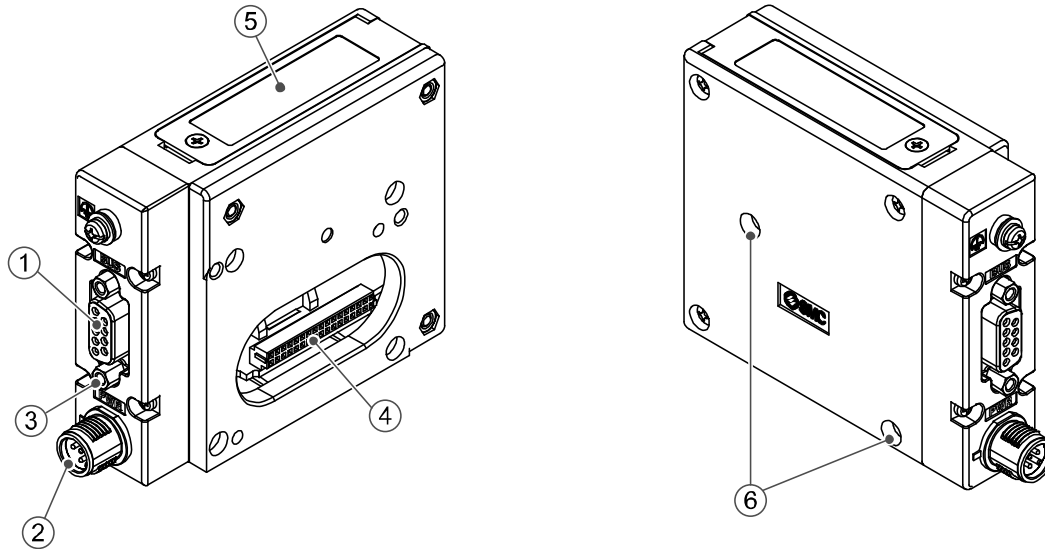

No.	Element	Description
1	Fieldbus interface connector	PROFIBUS DP connection. *1 (D-sub 9-pin socket)
2	Power supply connector	Power supply with load voltage for valves and operating voltage for SI unit. *1 (M12 5-pin plug, A-coded)
3	FE terminal	Functional earth. (M3 screw)
4	Output connector	Output signal interface for valve manifold.
5	LED and switch	LED display to indicate the status of the SI unit. *2 Switches for setting of node address and operating mode. *2
6	Mounting hole	Mounting hole for connection to the valve manifold.

Accessories

Hexagon socket head cap screw	2 pcs. M3 x 30 screw for connection to the valve manifold.
-------------------------------	--

*1: For details of suitable cables refer to the Accessories section on page 32.

*2: Refer to page 17 for the LED Indication and Settings.

Installation and Wiring

■ Installation

Connect valve manifold to the SI unit.

• Dimensions for installation

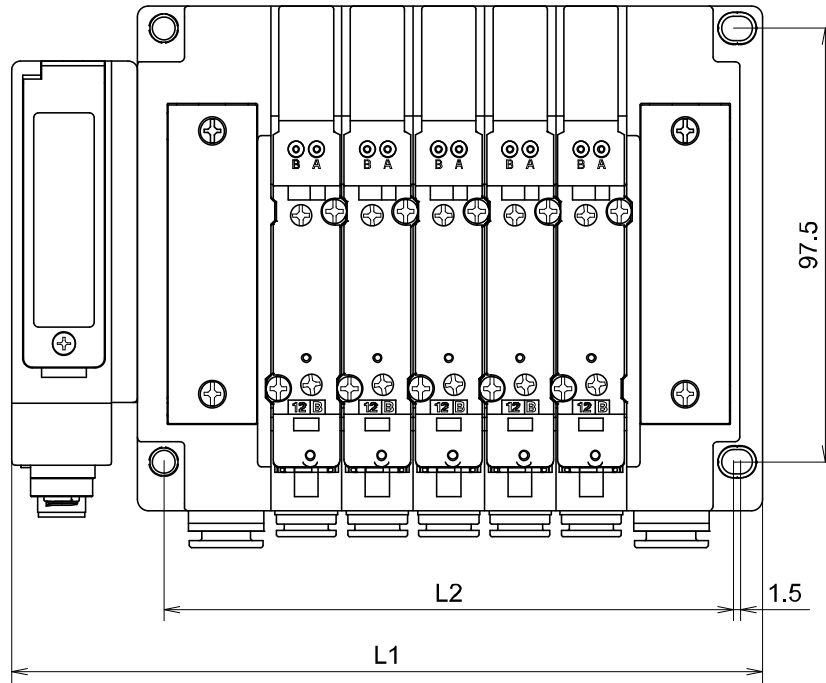

n: number of valve stations

L \ n	1	2	3	4	5	6	7	8	
L1		120.7	136.7	152.7	168.7	184.7	200.7	216.7	
L2		80	96	112	128	144	160	176	
L \ n	9	10	11	12	13	14	15	16	
L1		232.7	248.7	264.7	280.7	296.7	312.7	328.7	344.7
L2		192	208	224	240	256	272	288	304

(mm)

The above table shows dimensions as an example for the SY5000 series valve manifold.

Connectable valve manifolds are the same as for EX250 series SI unit.

Refer to the EX250 series valve manifold section in the valve catalogue for valve manifold dimensions.

■Wiring

Select the appropriate cables to mate with the connectors mounted on the SI unit.
Refer to Accessories (page 32).

- Fieldbus interface connector layout
<EX260-SPR1/-SPR2/-SPR3/-SPR4>

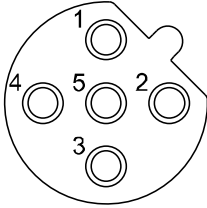

BUS OUT: M12 5-pin socket, B-coded (SPEEDCON)

No.	Designation	Description
1	-	Unused
2	RXD/TXD-N	Receive / transmit data, negative
3	-	Unused
4	RXD/TXD-P	Receive / transmit data, positive
5	-	Unused

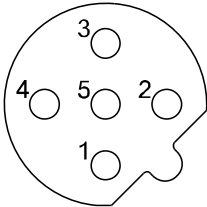

BUS IN: M12 5-pin plug, B-coded (SPEEDCON)

No.	Designation	Description
1	-	Unused
2	RXD/TXD-N	Receive / transmit data, negative
3	-	Unused
4	RXD/TXD-P	Receive / transmit data, positive
5	-	Unused

The M12 connector cable has two types, SPEEDCON compatible and non-compatible. If both plug and socket sides have connectors for SPEEDCON, the cable can be inserted and connected by turning it a 1/2 of a rotation, leading to reduction in work hour.
A non-compatible connector can be connected to a compatible connector as well as an M12.

BUS IN and BUS OUT fieldbus interface connectors are connected inside the SI unit for a daisy-chaining structure as shown in the circuit below.

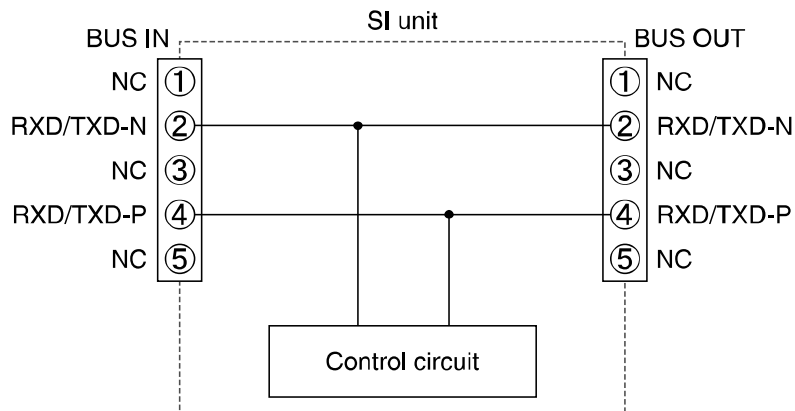

Note

- Be sure to fit a seal cap on any unused connectors.
Proper use of the seal cap enables the enclosure to achieve IP67 specification.

*: Refer to page 33 for the seal cap.

<EX260-SPR5/-SPR6/-SPR7/-SPR8>

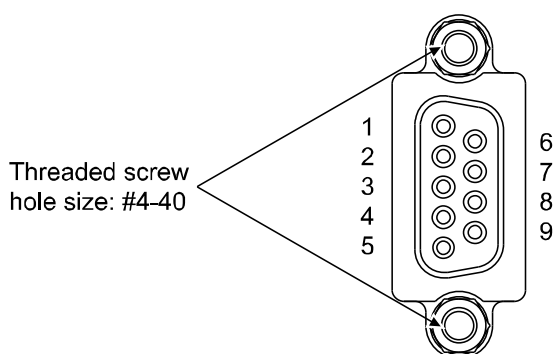

BUS: D-sub 9-pin socket

No.	Designation	Description
1	-	Unused
2	-	Unused
3	RXD/TXD-P	Receive / transmit data, positive
4	-	Unused
5	DGND	Data ground (reference potential to VP)
6	VP	Power supply plus (P5V)
7	-	Unused
8	RXD/TXD-N	Receive / transmit data, negative
9	-	Unused

Use the PROFIBUS DP connector with bus cable.
(e.g.: 6ES7 972-0BA12-0XA0, manufactured by Siemens)

○PROFIBUS DP bus cable

A shielded twisted pair cable for PROFIBUS DP should be used.
The maximum cable length depends on the transmission speed and the cable type used.

<PROFIBUS DP bus cable specification>

Cable: Shielded twisted pair cable (Type-A cable)

Impedance	135 to 165 Ω (3 to 20 MHz)
Capacitance between conductors	Less than 30 pF/m
Conductor resistance	110 Ω /km or less
Wire diameter	0.64 mm or more
Conductor area	0.34 mm ² or more

•Transmission speed and maximum cable length

Transmission speed [kbps]	9.6	19.2	45.45	93.75	187.5	500	1500	12000
Cable length (m)	1200				1000	400	200	100

○Power supply connector layout

PWR: M12 5-pin plug, A-coded (SPEEDCON)

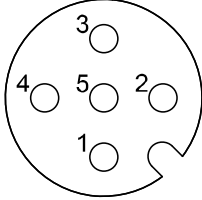

No.	Designation	Description
1	SV24 V	+24 V for solenoid valve
2	SV0 V	0 V for solenoid valve
3	SI24 V	+24 V for SI unit operation
4	SI0 V	0 V for SI unit operation
5	-	Unused

The M12 connector cable has two types, SPEEDCON compatible and non-compatible. If both plug and socket sides have connectors for SPEEDCON, the cable can be inserted and connected by turning it a 1/2 of a rotation, leading to reduction in work hour.
A non-compatible connector can be connected to a compatible connector as well as an M12.

Power-supply line for solenoid valve and power-supply line for SI unit operation are isolated.
 Be sure to supply power, respectively.
 Either single-source power or two different power supplies can be used.

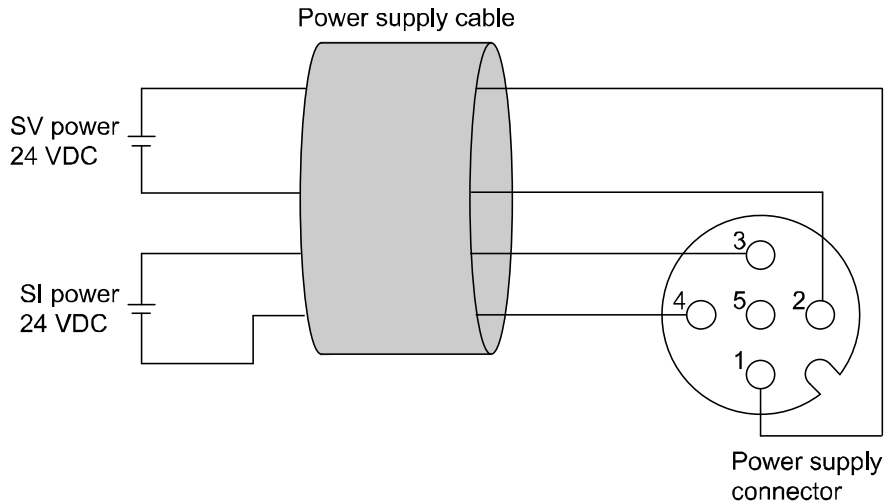

A. Two different power supply

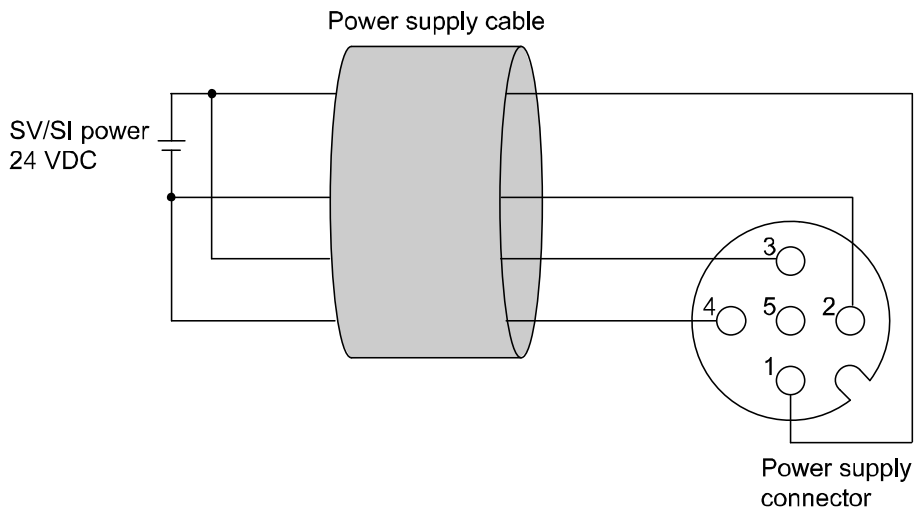

B. Single-source power supply

*: Pay attention not to exceed the tolerance range of power supply voltage.

○FE terminal

Connect the FE terminal to ground.

Resistance to ground should be 100 ohms or less.

<EX260-SPR1/-SPR2/-SPR3/-SPR4>

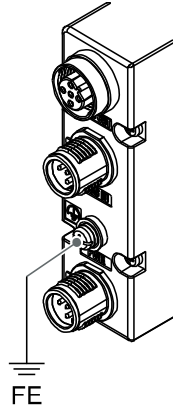

<EX260-SPR5/-SPR6/-SPR7/-SPR8>

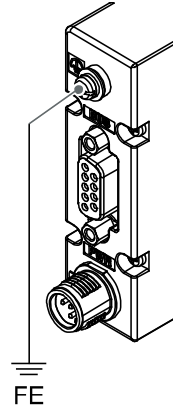

LED Indication and Settings

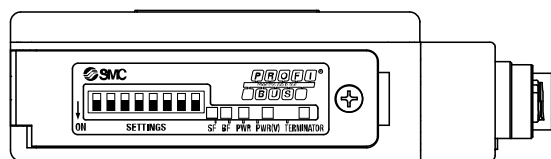

LED indication

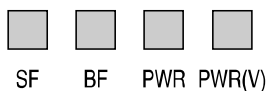

LED	Description
SF	System fault
BF	BUS fault
PWR	Turns ON in green when SI unit operating voltage is supplied
PWR(V)	Turns ON in green when load voltage for the valve is supplied. Turns OFF when load voltage for the valve is not supplied or outside tolerance range. (19 V or less)

<Indication of communication status>

SF status	BF status	Description
<input type="checkbox"/> OFF	<input type="checkbox"/> OFF	No fault. Communication connection to the master is established
<input type="checkbox"/> OFF	<input checked="" type="checkbox"/> Red ON	SI unit can not detect a transmission rate and the connection to the DP master has failed
<input type="checkbox"/> OFF	<input checked="" type="checkbox"/> Red flashing	SI unit has detected the transmission rate, but is not addressed by the DP master
<input checked="" type="checkbox"/> Red ON	<input type="checkbox"/> OFF	SI unit-related diagnostic error is detected (load power for the valve is not supplied or outside tolerance range)
<input checked="" type="checkbox"/> Red ON	<input checked="" type="checkbox"/> Red ON	SI unit PROFIBUS DP address outside range
<input checked="" type="checkbox"/> Red ON	<input checked="" type="checkbox"/> Red flashing	The configuration data sent from the DP master to the SI unit does not agree with the SI unit configuration

○PROFIBUS DP address setting and Fail safe setting (SETTINGS)

Set the PROFIBUS DP node address and fail safe mode, i.e. reaction of outputs to the communication error, of the SI unit using the 8-element switch.

Note

1. To set with switch, use a small blade screwdriver to flip the switches
2. Be sure to switch off the power before setting the switches.
3. Be sure to set with the switch before use.

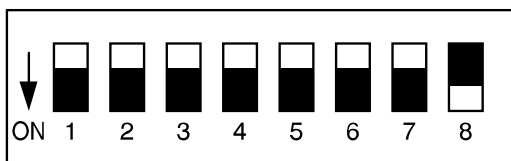

0: OFF 1: ON

Switch No.		No. 1	No. 2	No. 3	No. 4	No. 5	No. 6	No. 7	No. 8
ADDRESS		-	64	32	16	8	4	2	1
	1		0	0	0	0	0	0	1
	2		0	0	0	0	0	1	0
	3		0	0	0	0	0	1	1
	4		0	0	0	0	1	0	0
	:		:	:	:	:	:	:	:
	125		1	1	1	1	1	0	1
OUTPUT STATE	CLEAR	0							
	HOLD	1							

<PROFIBUS DP address setting (ADDRESS)>

The PROFIBUS DP address is binary coded and can be set from 1 to 125 using the 8-element switch.

*: Factory default setting is Address 1.

<Fail safe setting (OUTPUT STATE)>

Set the reaction of outputs to the communication error.

CLEAR: Clear all outputs.

HOLD: Hold the last state before communication error.

*: Factory default setting is CLEAR.

○Terminator

A bus termination is required at both ends of the PROFIBUS DP bus segment.

<EX260-SPR1/-SPR2/-SPR3/-SPR4>

The bus termination switch is built-in to EX260-SPR1/-SPR2/-SPR3/-SPR4.
Switch it ON if the SI unit is at the end of the fieldbus segment.

*: Factory default setting is OFF.

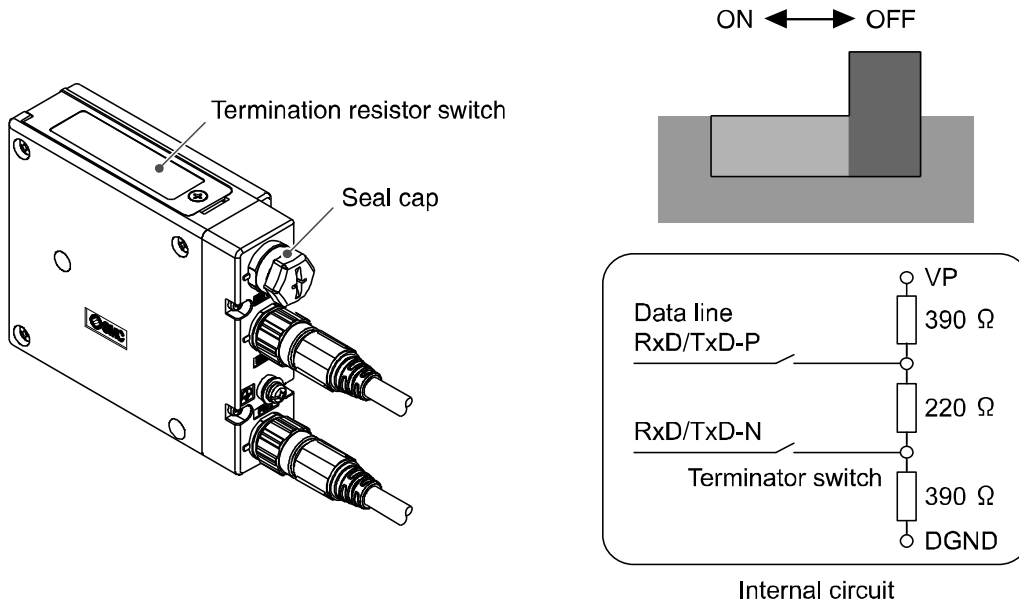

Note

- Be sure to fit a seal cap on any unused connectors.
 - Proper use of the seal cap enables the enclosure to achieve IP67 specification.
- *: Refer to page 33 for the seal cap.

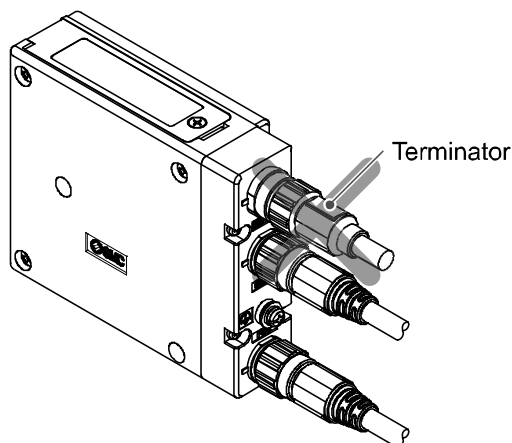

Note

An external termination resistor should not be used.
If an external termination resistor is used, the termination resistor value in the SI unit will be outside the specified range. A network communication error may occur.

<EX260-SPR5/-SPR6/-SPR7/-SPR8>

EX260-SPR5/-SPR6/-SPR7/-SPR8 do not have a built-in termination resistor.

Termination is required on the outside of the SI unit. A termination switch built-in to the PROFIBUS DP D-sub connector may be used.

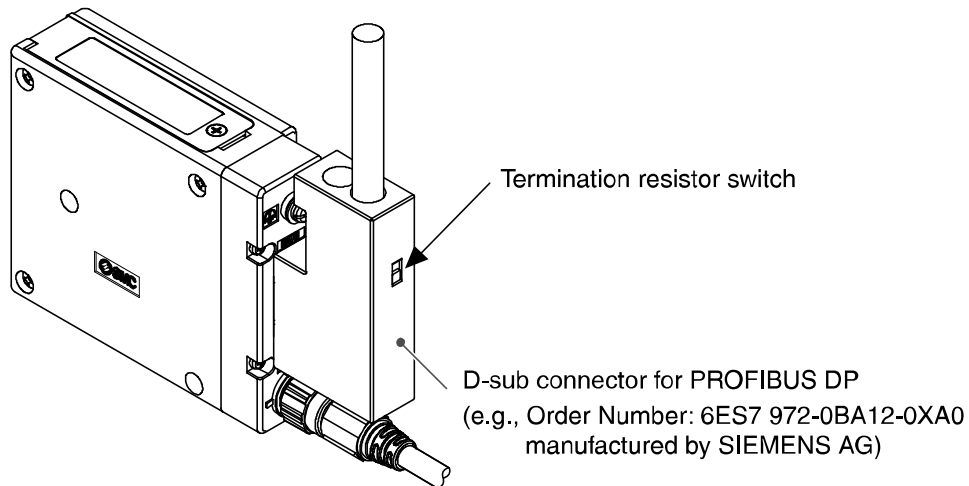

○ Configuration

In order to configure the SI unit in the PROFIBUS DP network, the appropriate device master file (GSD file) for the SI unit will be required.

The current GSD file can be found on the SMC website (URL <http://www.smcworld.com>).

GSD file

	Part number	GSD file
1	EX260-SPR1/-SPR2	Smc_1430.gsd
2	EX260-SPR3/-SPR4	Smc_1431.gsd
3	EX260-SPR5/-SPR6	Smc_1432.gsd
4	EX260-SPR7/-SPR8	Smc_1433.gsd

The following sections describe as an example the main configuration steps with the STEP7 software.

- (1) Copy the GSD file for the SI unit (Smc_143*.gsd) into the directory on your PC.
- (2) Start up STEP7, and execute “Options” – “Install GSD Files” from the HW Config tools.
- (3) Open “View” and “Catalog”, then an icon “Valves” is added underneath PROFIBUS DP – Additional Field Devices. Drag and drop “EX260-SPR” under the icon “Valves”, then the icon will be added into the PROFIBUS DP line.
- (4) Download the setting into the PLC.
Click the icon (a) “Save and Compile” and compile.
After compiling is completed, click the icon (b) “Download to Module” and download.

Now the configuration is complete.

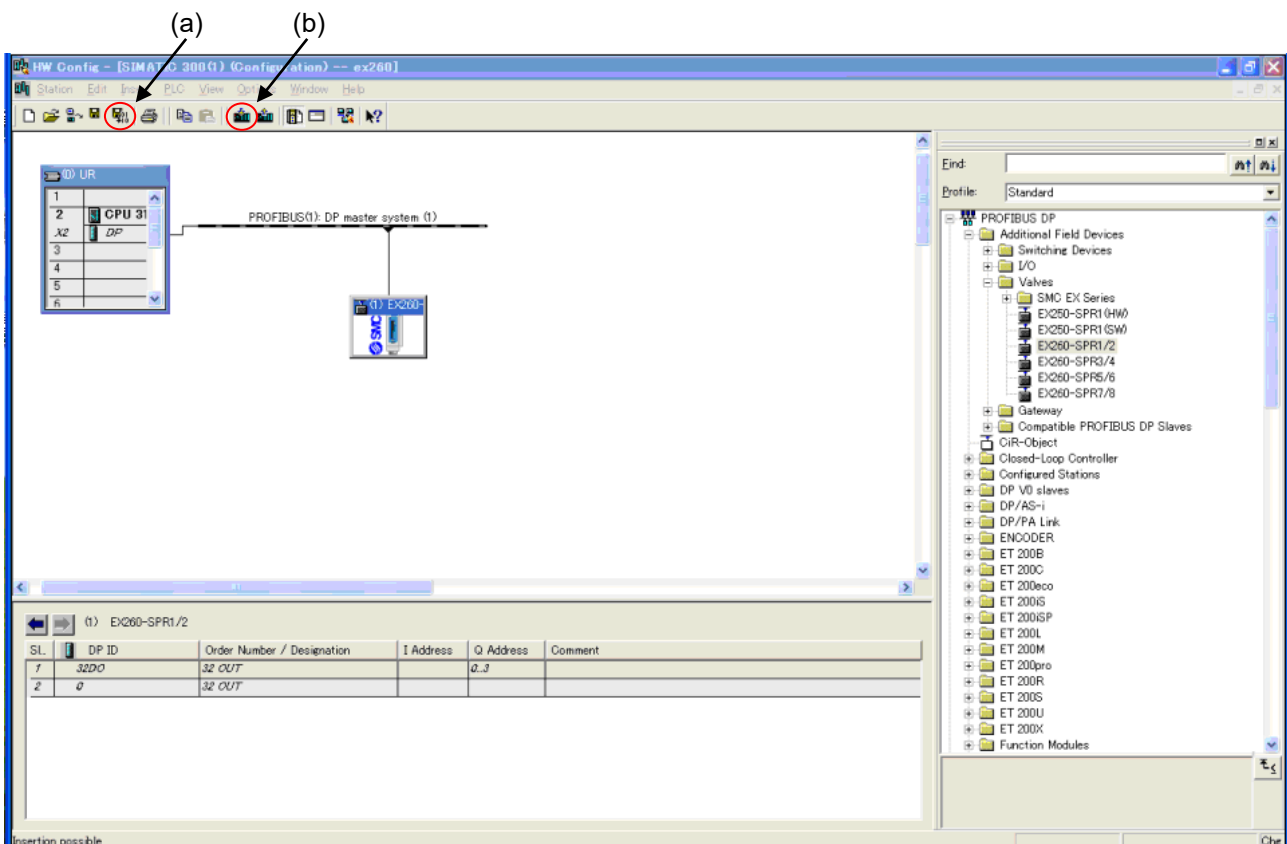

STEP7 software is manufactured by Siemens AG. STEP7 is a registered trademark for Siemens AG.

○Output number assignment
Output data

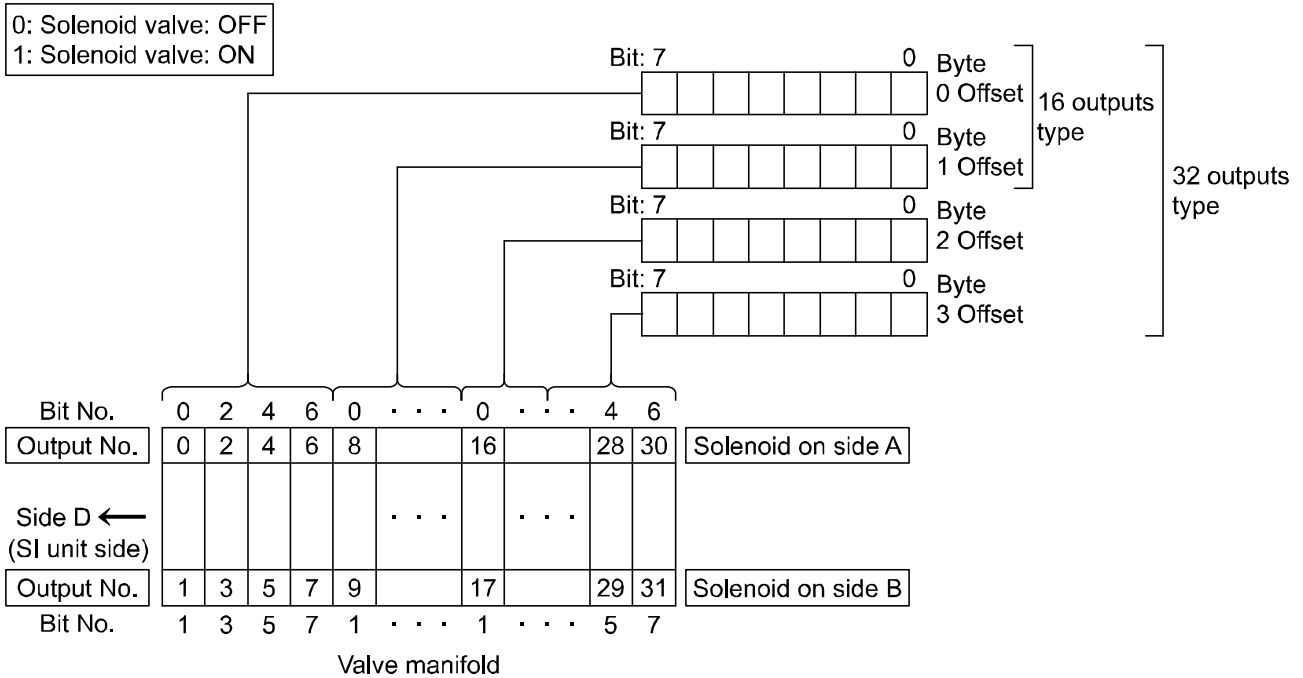

- *: The output number refers to the solenoid position on the manifold and starts at zero.
- *: Standard wiring on the manifold is for double-solenoid valves and output number starts A side and B side in that order as shown in the figure a.
If you mount a single-solenoid valve on the standard wiring manifold, output number for B side valve is skipped.
- *: Custom wiring for mixed mounting single-solenoid valves and double-solenoid-valves can be specified with a Wiring Specification Sheet. Example wiring is shown in the figure b.
- *: Bit status "0" and "1" on a data corresponds solenoid valve status ON and OFF (0: OFF, 1: ON), and output number starts at zero from LSB (least significant bit).

fig.a

	No.	Station	No.	
Double	4	3	5	
Single	2	2	3	free
Double	0	1	1	

fig.b

	No.	Station	No.
Double	3	3	4
Single	2	2	-
Double	0	1	1

Byte1: Station Status 2

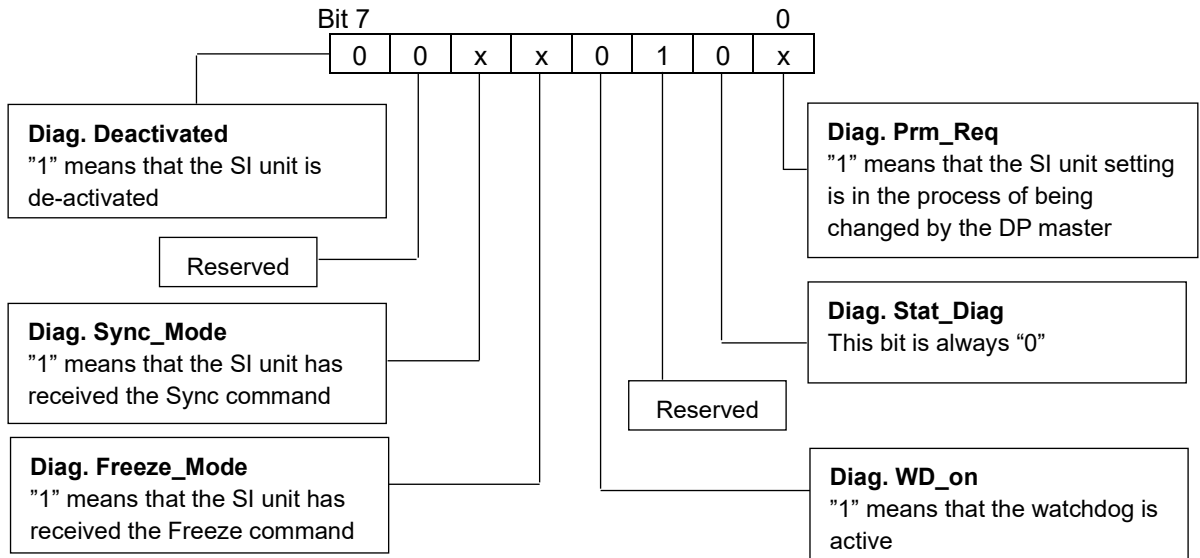

Byte2: Station Status 3

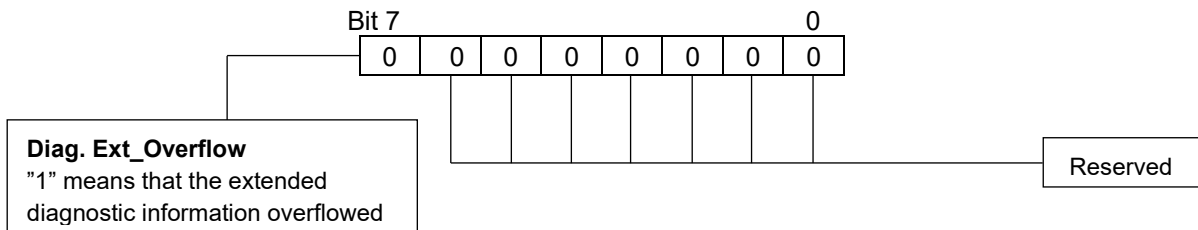

Byte3: Diag.Master_Add
Shows the DP master address.

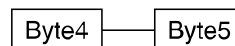

Byte4, 5: Ident_Number
Shows the SI unit address.



Byte6: Diag.Header
Shows the supported byte count of the extended diagnostic data. (two bytes fixed)

Byte7: SI unit status information

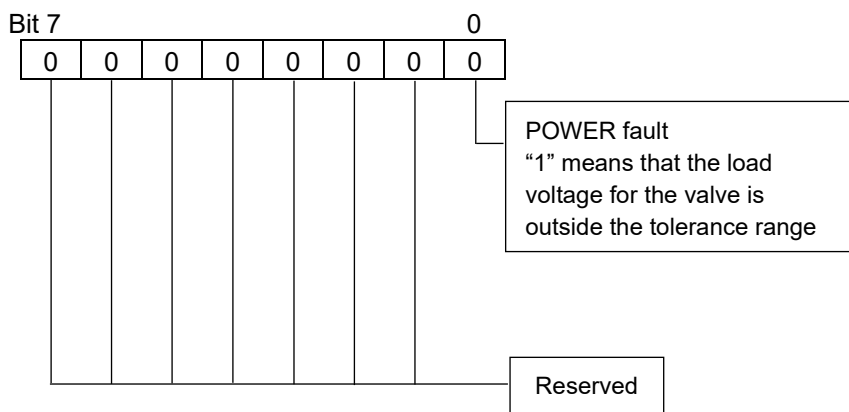

Troubleshooting and Maintenance

○ Troubleshooting chart

When any malfunction is observed, it is recommended to perform the following troubleshooting.

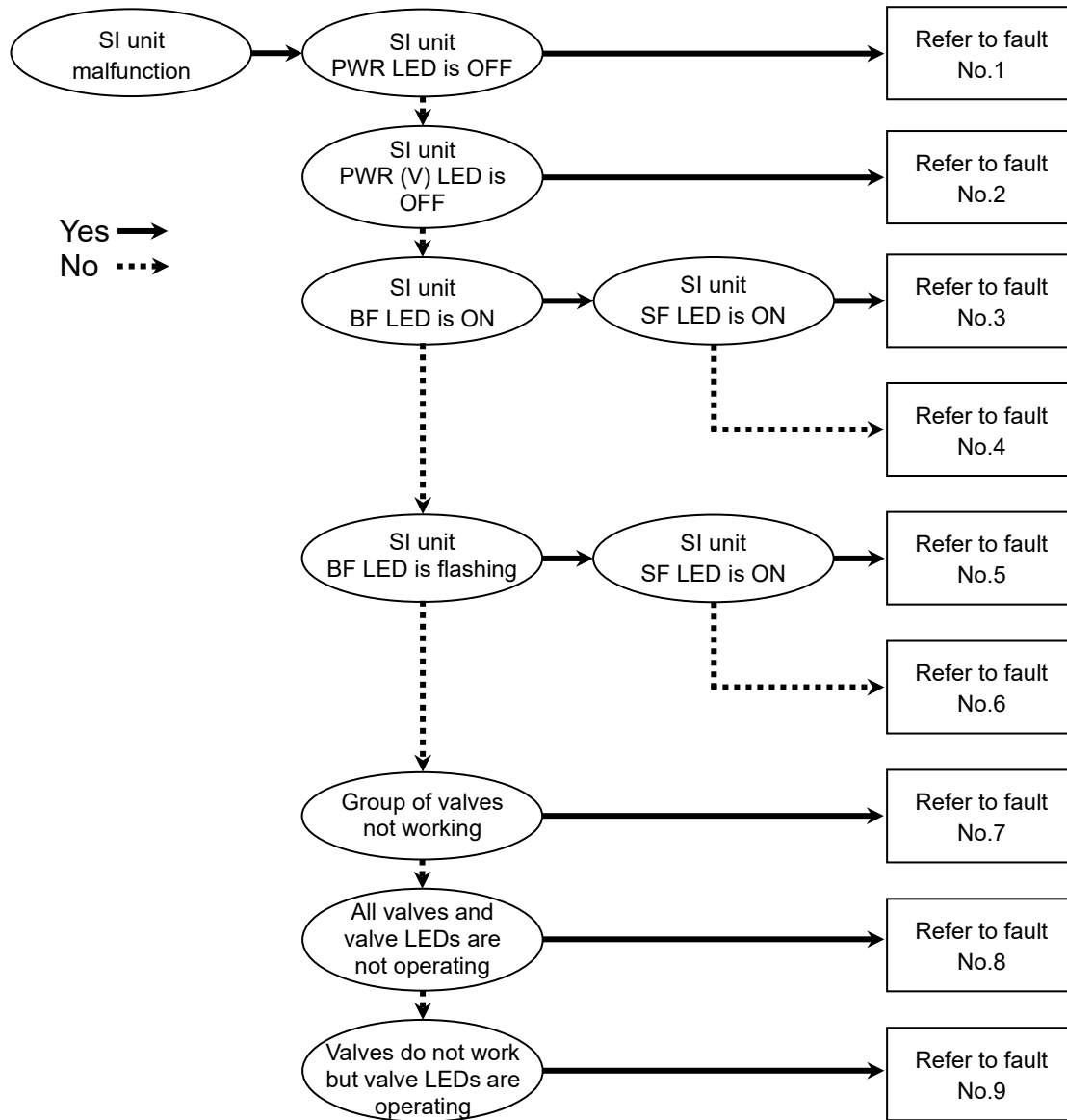

Troubleshooting table

Fault No.1

Fault	Probable cause	Recommended error handling	Recommended action
SI unit PWR LED is OFF	Defective power cable wiring for SI unit operation	Check the condition of the power cable wiring to the SI unit.	Re-tighten the power cable. (Replace the cable if it is broken)
			Correct the power cable wiring layout.
	SI unit operating voltage is not supplied	Check the condition of the supply voltage to the SI unit.	Supply 24 VDC \pm 10% to the SI unit.

Fault No.2

Fault	Probable cause	Recommended error handling	Recommended action
SI unit PWR(V) LED is OFF	Defective power cable wiring for the solenoid valve	Check the condition of the power cable wiring for the valve.	Re-tighten the power cable. (Replace the cable if it is broken)
			Correct the power cable wiring layout.
	Load voltage for the valve is not supplied	Check the condition of the supply voltage for the valve.	Supply 24 VDC +10%/-5% to the valve.

Fault No.3

Fault	Probable cause	Recommended error handling	Recommended action
SI unit BF LED is ON SF LED is ON	Invalid PROFIBUS address on the SI unit	Check the PROFIBUS address setting on the SI unit.	Set the valid PROFIBUS address (1 to 125) on the SI unit.

Fault No.4

Fault	Probable cause	Recommended error handling	Recommended action
SI unit BF LED is ON SF LED is OFF	The connection to the DP master has failed.	Check the condition of the bus cable wiring, and there is no broken bus cable.	Re-tighten the bus cable. (Replace the cable if it is broken)
		Check that the bus cable length is within specification. Check that the bus termination is correctly installed at both ends of PROFIBUS DP bus segment. Check that the certified PROFIBUS cable is used.	Configure bus cables as specified by PROFIBUS DP specification.
		Check that there is no noise source or high voltage line around the bus cables.	Keep noise sources away from bus cable.

Fault No.5

Fault	Probable cause	Recommended error handling	Recommended action
SI unit BF LED is flashing SF LED is ON	Invalid configuration data	Check if the configured setup to the SI unit by DP master match the actual setup of the SI unit.	Configure the SI unit by DP master using valid GSD file.

Fault No.6

Fault	Probable cause	Recommended error handling	Recommended action
SI unit BF LED is flashing SF LED OFF	Missing configuration	Check if the configured SI unit address on the DP master match the actual SI unit address.	Match the actual SI unit address with the configured SI unit address on the DP master.

Fault No.7

Fault	Probable cause	Recommended error handling	Recommended action
Group of valves not working	Too many valves	Check if solenoid count does not exceed the allowable number. This depends on the SI unit model and valve series. Allowable solenoid number by valve series: SY/SV series: 32 points VQC/S0700 series: 24 points	Keep the number of mounted solenoid valves within specification.

Fault No.8

Fault	Probable cause	Recommended error handling	Recommended action
All valves and valve LEDs are not operating	Poor connection between SI unit and valve manifold	Check if there are any loose screws making the connection between the SI unit and the valve manifold	Tighten the screws with the specified tightening torque (i.e.: 0.6 N•m) and make sure there is no gap between the SI unit and the valve manifold.
	Mismatch polarity between solenoid valve and SI unit output	Check if the solenoid valve common specification matches the output polarity of the SI unit.	Match polarity between solenoid valve and SI unit output.
	Defective solenoid valve	Follow the troubleshooting for the solenoid valve.	Same as left.

Fault No.9

Fault	Probable cause	Recommended error handling	Recommended action
Valves do not work but valve LEDs are operating	Mismatch polarity between solenoid valve and SI unit output	Check if the solenoid valve common specification match the output polarity of the SI unit.	Match polarity between solenoid valve and SI unit output.

○Maintenance

Replacement of the SI unit

- Remove the M3 hexagon screws from the SI unit and release the SI unit from the valve manifold.
- Replace the SI unit.
- Tighten the screws with the specified tightening torque. (0.6 N·m)

Precautions for maintenance

- (1) Be sure to switch off the power.
- (2) Check there is no foreign matter inside the SI unit.
- (3) Check there is no damage and no foreign matter stuck to the gasket.
- (4) Be sure to tighten the screws with the specified torque.

If the SI unit is not assembled properly, inside PCBs may be damaged or liquid and/or dust may enter into the unit.

○Assembly and disassembly of the SI unit

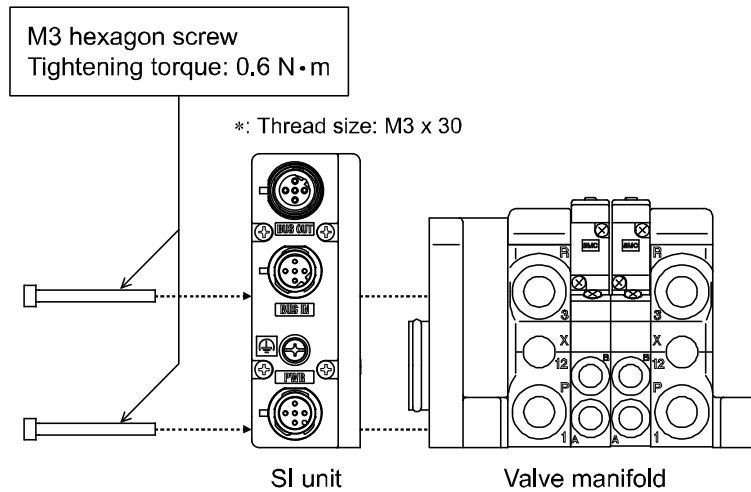

Specifications

■ Specifications

General specifications

Item	Specifications
Ambient temperature	-10 to +50 °C
Ambient humidity	35 to 85%RH (No condensate)
Ambient temperature for storage	-20 to +60 °C
Withstand voltage	500 VAC applied for 1 minute
Insulation resistance	500 VDC, 10 MΩ or more
Operating atmosphere	No corrosive gas
Enclosure	EX260-SPR1/-SPR2/-SPR3/-SPR4: IP67 EX260-SPR5/-SPR6/-SPR7/-SPR8: IP40
Weight	200 g or less
Standard	UL/CSA, CE/UKCA marked

Electrical specifications

Item		Specifications
Current consumption in power supply voltage range	Current consumption of control power supply	21.6 to 26.4 VDC * 0.1 A max.
	Solenoid valve power supply	22.8 to 26.4 VDC * 2.0 A or less, according to the solenoid valve station specification
Solenoid valve connecting specification	Output type	EX260-SPR1/-SPR3/-SPR5/-SPR7 PNP (negative common) / source
		EX260-SPR2/-SPR4/-SPR6/-SPR8 NPN (positive common) / sink
	Connected load	Solenoid valve with surge voltage suppressor of 24 VDC and 1.5 W or less (manufactured by SMC)
	Insulation type	Photo coupler insulation type
	Residual voltage	0.4 VDC or less

*: When conformity to UL is required, the SI unit should be used with a UL1310 Class 2 power supply.

Network communication specifications

Item		Specifications
Protocol		PROFIBUS DP (EN50170, EN50254)
Transmission speed		9.6, 19.2, 45.45, 93.75, 187.5, 500, 1500, 3000, 6000, 12000 (kbps)
Device type		DP slave
Number of outputs	EX260-SPR1/-SPR2/-SPR5/-SPR6	32 outputs
	EX260-SPR3/-SPR4/-SPR7/-SPR8	16 outputs
Configuration file	EX260-SPR1/-SPR2	Smc_1430.gsd
	EX260-SPR3/-SPR4	Smc_1431.gsd
	EX260-SPR5/-SPR6	Smc_1432.gsd
	EX260-SPR7/-SPR8	Smc_1433.gsd

Connectable valve series

Valve series	
SY series	SY3000, SY5000, SY7000
VQC series	VQC1000, VQC2000, VQC4000
SV series	SV1000, SV2000, SV3000 (10 type tie-rod base)
S0700 series	S0700

*: The valve manifolds that can be connected are the same as those connectable to EX250 series.

■Dimensions

•EX260-SPR1/-SPR2/-SPR3/-SPR4

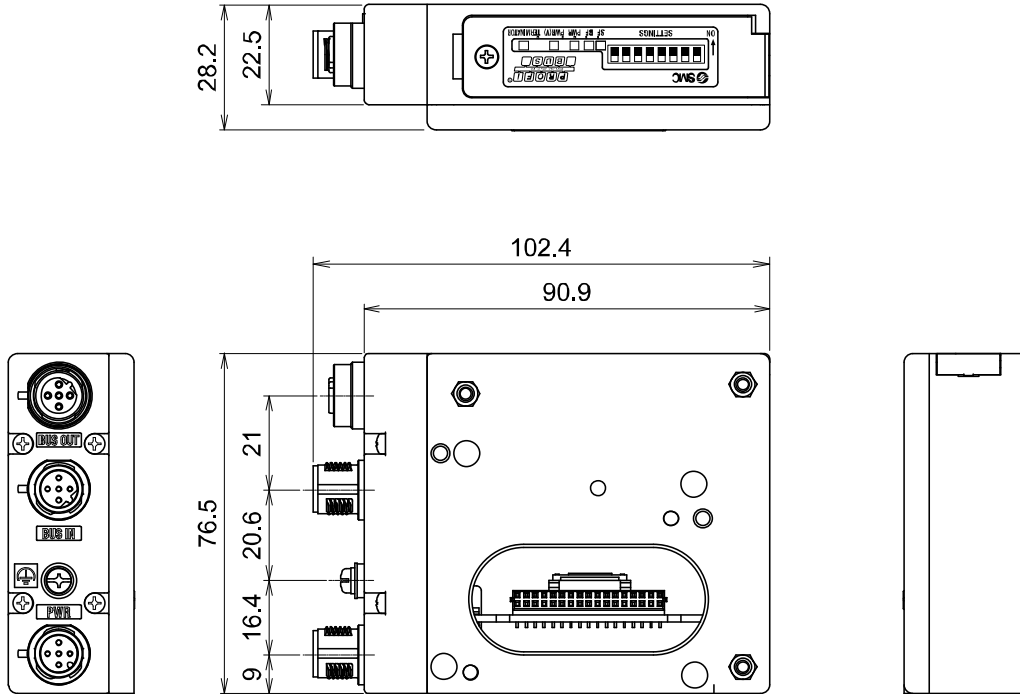

•EX260-SPR5/-SPR6/-SPR7/-SPR8

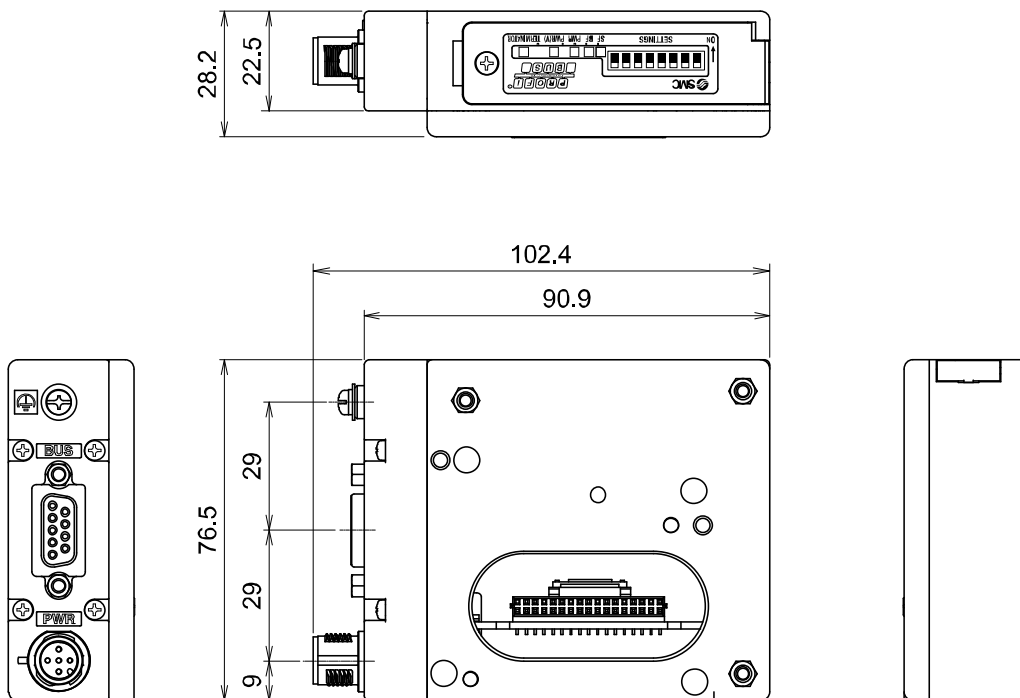

- If a fieldwireable connector is used for the power supply connection, and the SI unit is installed directly to a valve manifold, the cable connector's outer diameter should be $\phi 16$ mm or less. If it is a larger diameter, the connector will interfere with the mounting surface. Recommended cables are specified in the accessories section, on page 32.

Accessories

•EX260-SPR1/-SPR2/-SPR3/-SPR4

○Fieldbus interface connector (BUS OUT)

(1) Cable with communication connector for PROFIBUS DP (SPEEDCON)

Part number: PCA-1557691

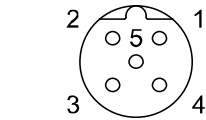

Plug connector
pin assignment
B-coded (Reverse key)

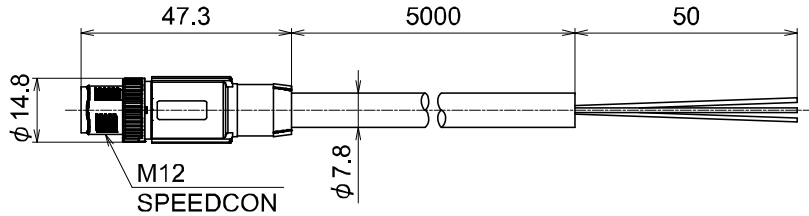

Item	Specifications
Connector	M12 Straight (SPEEDCON)
Cable length	5000 mm
Cable O.D.	φ7.8 mm
Nominal cross section	AWG22
Wire diameter (Including insulator)	2.55 mm
Min. bending radius (Fixed)	78 mm

Pin No.	Cable colour: Signal
1	: Unused
2	Green: RXD/TXD-N
3	: Unused
4	Red : RXD/TXD-P
5	: Unused

(2) Fieldwireable connector for PROFIBUS DP (SPEEDCON)

Part number: PCA-1075530

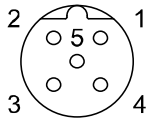

Plug connector
pin assignment
B-coded (Reverse key)

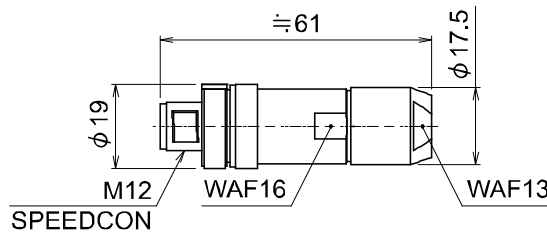

Applicable cable

Item	Specifications
Cable O.D.	φ4.0 to 8.0 mm
Electric wire cross section (Twist line)	AWG26 to 20

Pin No.	Cable color: Signal
1	: Unused
2	Green: RXD/TXD-N
3	: Unused
4	Red :RXD/TXD-P
5	: Unused

(3) Seal cap

Part number: EX9-AWTS

The cap is used to protect the M12 connector opening when the connector is not used on the EX260-SPR1/-SPR2/-SPR3/-SPR4.

When the "BUS OUT" connector is not used, the seal cap can keep the SI unit under IP67 rated protection.

(One seal cap will be attached to the SI unit EX260-SPR1/-SPR2/-SPR3/-SPR4 when shipped from factory.)

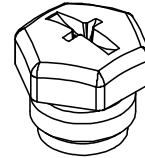

Description	Part No.	Specification
Seal cap	EX9-AWTS	For M12 connector socket: 10 pcs.

○Fieldbus interface connector (BUS IN)

(1) Cable with communication connector for PROFIBUS DP (SPEEDCON)

Part number: PCA-1557688

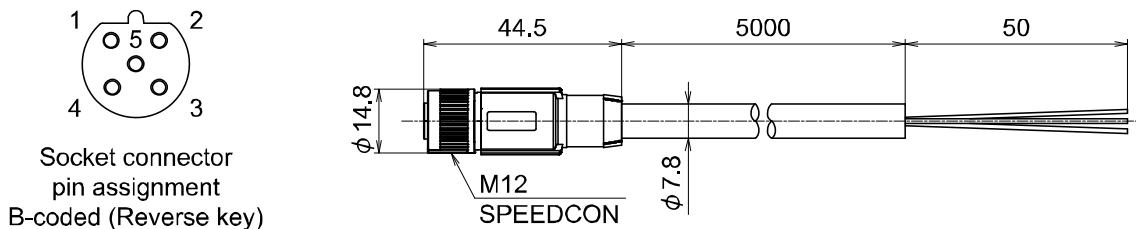

Item	Specifications
Connector	M12 Straight (SPEEDCON)
Cable length	5000 mm
Cable O.D.	φ7.8 mm
Nominal cross section	AWG22
Wire diameter (Including insulator)	2.55 mm
Min. bending radius (Fixed)	78 mm

Pin No.	Cable colour: Signal
1	: Unused
2	Green: RXD/TXD-N
3	: Unused
4	Red : RXD/TXD-P
5	: Unused

(2) Fieldwireable connector for PROFIBUS DP (SPEEDCON)

Part number: PCA-1075531

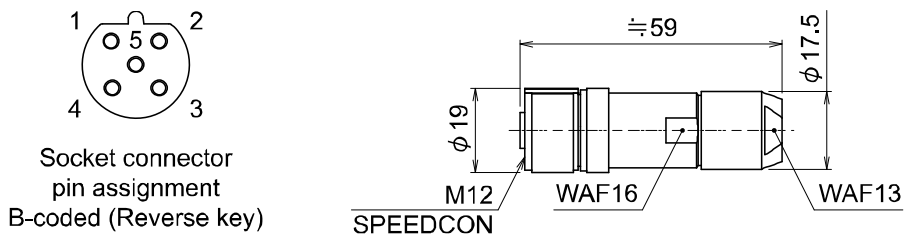

Applicable cable

Item	Specifications
Cable O.D.	φ4.0 to 8.0 mm
Electric wire cross section (Twist line)	AWG26 to 20

Pin No.	Cable colour: Signal
1	: Unused
2	Green: RXD/TXD-N
3	: Unused
4	Red : RXD/TXD-P
5	: Unused

•EX260-SPR5/-SPR6/-SPR7/-SPR8

SI unit connector	Compatible connector			
	Description	Part number	Specifications	Manufacturer
Fieldbus interface connector (BUS)	D-sub connector	6ES7 972-0BA12-0XA0	RS485 BUS connector	SIEMENS

- Power supply connector
- (1) Cable with power supply connector

Part number: EX500-AP010-S

Connector specifications

S	Straight
A	Angle

Cable length (L)

1	1000 [mm]
5	5000 [mm]

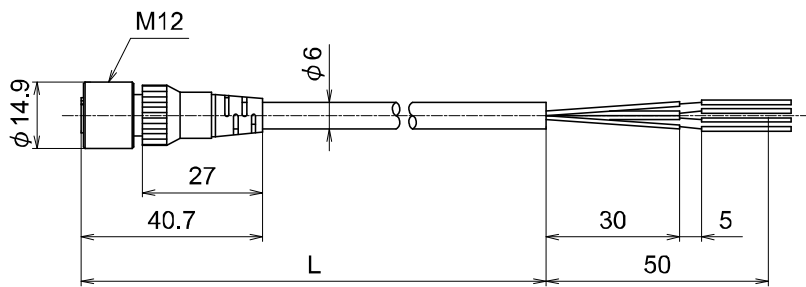

EX500-AP0#0-S

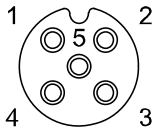

Socket connector
pin assignment
A-coded (Normal key)

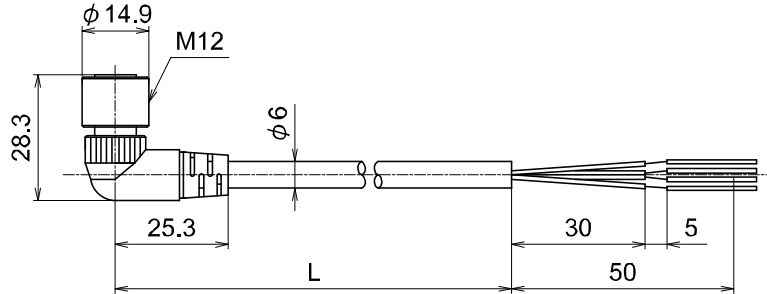

EX500-AP0#0-A

Item	Specifications
Cable O.D.	φ6 mm
Nominal cross section	AWG22
Wire diameter (Including insulator)	1.5 mm
Min. bending radius (Fixed)	40 mm

Pin No.	Cable colour: Signal
1	Brown: 24 VDC (For solenoid valve)
2	White : 0 V (For solenoid valve)
3	Blue : 24 VDC (For control)
4	Black : 0 V (For control)
5	Gray : Not connected

(2) Cable with power supply connector (SPEEDCON)

Part number: PCA-1401804

• Cable length (L)

4	1500 [mm]
5	3000 [mm]
6	5000 [mm]

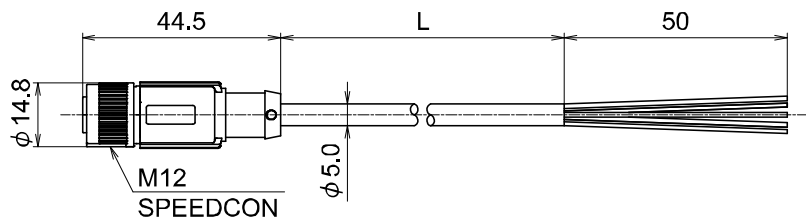
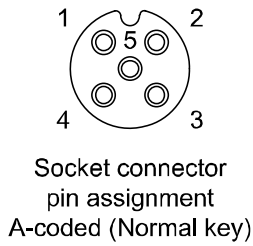

Item	Specifications
Connector	M12 Straight (SPEEDCON)
Cable O.D.	φ5 mm
Nominal cross section	AWG22
Wire diameter (Including insulator)	1.27 mm
Min. bending radius (Fixed)	21.7 mm

Pin No.	Cable colour: Signal
1	Brown: 24 VDC (For solenoid valve)
2	White : 0 V (For solenoid valve)
3	Blue : 24 VDC (For control)
4	Black : 0 V (For control)
5	Green/Yellow: Not connected

Revision history

A: Revise some wording
B: Revision
C: Revision
D: Limited warranty and Disclaimer are added.
E: Contents revised in several places.
F: Contents are added. [July 2016]
G: Contents are added. [June 2022]
H: Contents revised in several places [May 2024]

SMC Corporation

Tel: + 81 3 5207 8249 Fax: +81 3 5298 5362

URL <https://www.smcworld.com>

Note: Specifications are subject to change without prior notice and any obligation on the part of the manufacturer.
© SMC Corporation All Rights Reserved



No.EX※※-OMN0009-H