



Operation Manual

PRODUCT NAME

SI unit for DeviceNet[®]

MODEL / Series / Product Number

EX260-SDN#

SMC Corporation

Table of Contents

Safety Instructions	2
Model Indication and How to Order	8
Summary of Product elements	9
Installation and Wiring	10
Installation	10
Wiring	11
LED Indication and Settings	15
DeviceNet® Objects	20
Troubleshooting and Maintenance	28
Specification	33
Specifications	33
Dimensions	35
Accessories	36



Safety Instructions

These safety instructions are intended to prevent hazardous situations and/or equipment damage. These instructions indicate the level of potential hazard with the labels of “**Caution**,” “**Warning**” or “**Danger**.” They are all important notes for safety and must be followed in addition to International Standards (ISO/IEC)*1), and other safety regulations.

*1) ISO 4414: Pneumatic fluid power - General rules and safety requirements for systems and their components
ISO 4413: Hydraulic fluid power - General rules and safety requirements for systems and their components
IEC 60204-1: Safety of machinery - Electrical equipment of machines - Part 1: General requirements
ISO 10218-1: Robots and robotic devices - Safety requirements for industrial robots - Part 1: Robots
etc.



Danger

Danger indicates a hazard with a high level of risk which, if not avoided, will result in death or serious injury.



Warning

Warning indicates a hazard with a medium level of risk which, if not avoided, could result in death or serious injury.



Caution

Caution indicates a hazard with a low level of risk which, if not avoided, could result in minor or moderate injury.

Warning

1. The compatibility of the product is the responsibility of the person who designs the equipment or decides its specifications.

Since the product specified here is used under various operating conditions, its compatibility with specific equipment must be decided by the person who designs the equipment or decides its specifications based on necessary analysis and test results. The expected performance and safety assurance of the equipment will be the responsibility of the person who has determined its compatibility with the product. This person should also continuously review all specifications of the product referring to its latest catalog information, with a view to giving due consideration to any possibility of equipment failure when configuring the equipment.

2. Only personnel with appropriate training should operate machinery and equipment.

The product specified here may become unsafe if handled incorrectly. The assembly, operation and maintenance of machines or equipment including our products must be performed by an operator who is appropriately trained and experienced.

3. Do not service or attempt to remove product and machinery/equipment until safety is confirmed.

1. The inspection and maintenance of machinery/equipment should only be performed after measures to prevent falling or runaway of the driven objects have been confirmed.

2. When the product is to be removed, confirm that the safety measures as mentioned above are implemented and the power from any appropriate source is cut, and read and understand the specific product precautions of all relevant products carefully.

3. Before machinery/equipment is restarted, take measures to prevent unexpected operation and malfunction.

4. Our products cannot be used beyond their specifications. Our products are not developed, designed, and manufactured to be used under the following conditions or environments. Use under such conditions or environments is not covered.

1. Conditions and environments outside of the given specifications, or use outdoors or in a place exposed to direct sunlight.

2. Use for nuclear power, railways, aviation, space equipment, ships, vehicles, military application, equipment affecting human life, body, and property, fuel equipment, entertainment equipment, emergency shut-off circuits, press clutches, brake circuits, safety equipment, etc., and use for applications that do not conform to standard specifications such as catalogs and operation manuals.

3. Use for interlock circuits, except for use with double interlock such as installing a mechanical protection function in case of failure. Please periodically inspect the product to confirm that the product is operating properly.



Safety Instructions

Caution

We develop, design, and manufacture our products to be used for automatic control equipment, and provide them for peaceful use in manufacturing industries.

Use in non-manufacturing industries is not covered.

Products we manufacture and sell cannot be used for the purpose of transactions or certification specified in the Measurement Act.

The new Measurement Act prohibits use of any unit other than SI units in Japan.

Limited warranty and Disclaimer/Compliance Requirements

The product used is subject to the following “Limited warranty and Disclaimer” and “Compliance Requirements”.

Read and accept them before using the product.

Limited warranty and Disclaimer

1. The warranty period of the product is 1 year in service or 1.5 years after the product is delivered, whichever is first.*2)

Also, the product may have specified durability, running distance or replacement parts. Please consult your nearest sales branch.

2. For any failure or damage reported within the warranty period which is clearly our responsibility, a replacement product or necessary parts will be provided.

This limited warranty applies only to our product independently, and not to any other damage incurred due to the failure of the product.

3. Prior to using SMC products, please read and understand the warranty terms and disclaimers noted in the specified catalog for the particular products.

***2) Vacuum pads are excluded from this 1 year warranty.**

A vacuum pad is a consumable part, so it is warranted for a year after it is delivered.

Also, even within the warranty period, the wear of a product due to the use of the vacuum pad or failure due to the deterioration of rubber material are not covered by the limited warranty

Compliance Requirements

1. The use of SMC products with production equipment for the manufacture of weapons of mass destruction (WMD) or any other weapon is strictly prohibited.

2. The exports of SMC products or technology from one country to another are governed by the relevant security laws and regulations of the countries involved in the transaction. Prior to the shipment of a SMC product to another country, assure that all local rules governing that export are known and followed.

Operator

- ◆ This operation manual is intended for those who have knowledge of machinery using pneumatic equipment, and have sufficient knowledge of assembly, operation and maintenance of such equipment. Only those persons are allowed to perform assembly, operation and maintenance.
- ◆ Read and understand this operation manual carefully before assembling, operating or providing maintenance to the product.

■ Safety Instructions

Warning

- Do not disassemble, modify (including changing the printed circuit board) or repair.
An injury or failure can result.
- Do not operate the product outside of the specifications.
Do not use for flammable or harmful fluids.
Fire, malfunction, or damage to the product can result.
Verify the specifications before use.
- Do not operate in an atmosphere containing flammable or explosive gases.
Fire or an explosion can result.
This product is not designed to be explosion proof.
- If using the product in an interlocking circuit:
 - Provide a double interlocking system, for example a mechanical system.
 - Check the product regularly for proper operation.Otherwise malfunction can result, causing an accident.
- The following instructions must be followed during maintenance:
 - Turn off the power supply.
 - Stop the air supply, exhaust the residual pressure and verify that the air is released before performing maintenance.Otherwise an injury can result.

Caution

- After maintenance is complete, perform appropriate functional inspections.
Stop operation if the equipment does not function properly.
Safety cannot be assured in the case of unexpected malfunction.
- Provide grounding to assure the noise resistance of the Serial System.
Individual grounding should be provided close to the product with a short cable.

■NOTE

- Follow the instructions given below when designing, selecting and handling the product.
- The instructions on design and selection (installation, wiring, environment, adjustment, operation, maintenance, etc.) described below must also be followed.
 - *Product specifications
 - When conformity to UL is required, the SI unit should be used with a UL1310 Class 2 power supply.
 - The SI unit is a UL approved product only if they have a  mark on the body.
 - Use the specified voltage.
Otherwise failure or malfunction can result.
 - Reserve a space for maintenance.
Allow sufficient space for maintenance when designing the system.
 - Do not remove any nameplates or labels.
This can lead to incorrect maintenance, or misreading of the operation manual, which could cause damage or malfunction to the product.
It may also result in non-conformity to safety standards.

•Product handling

*Installation

- Do not drop, hit or apply excessive shock to the fieldbus system.
Otherwise damage to the product can result, causing malfunction.
- Tighten to the specified tightening torque.
If the tightening torque is exceeded the mounting screws may be broken.
IP67 protection cannot be guaranteed if the screws are not tightened to the specified torque.
- Never mount a product in a location that will be used as a foothold.
The product may be damaged if excessive force is applied by stepping or climbing onto it.

*Wiring

- Avoid repeatedly bending or stretching the cables, or placing heavy load on them.
Repetitive bending stress or tensile stress can cause breakage of the cable.
- Wire correctly.
Incorrect wiring can break the product.
- Do not perform wiring while the power is on.
Otherwise damage to the fieldbus system and/or I/O device can result, causing malfunction.
- Do not route wires and cables together with power or high voltage cables.
Otherwise the fieldbus system and/or I/O device can malfunction due to interference of noise and surge voltage from power and high voltage cables to the signal line.
Route the wires (piping) of the fieldbus system and/or I/O device separately from power or high voltage cables.
- Confirm proper insulation of wiring.
Poor insulation (interference from another circuit, poor insulation between terminals, etc.) can lead to excess voltage or current being applied to the product, causing damage.
- Take appropriate measures against noise, such as using a noise filter, when the fieldbus system is incorporated into equipment.
Otherwise noise can cause malfunction.

*Environment

- Select the proper type of protection according to the environment of operation.
IP67 protection is achieved when the following conditions are met.
 - (1) The units are connected properly with fieldbus cable with M12 connector and power cable with M12 (M8) connector.
 - (2) Suitable mounting of each unit and manifold valve.If using in an environment that is exposed to water splashes, please take measures such as using a cover.
- Do not use in a place where the product could be splashed by oil or chemicals.
If the product is to be used in an environment containing oils or chemicals such as coolant or cleaning solvent, even for a short time, it may be adversely affected (damage, malfunction etc.).
- Do not use the product in an environment where corrosive gases or fluids could be splashed.
Otherwise damage to the product and malfunction can result.
- Do not use in an area where surges are generated.
If there is equipment which generates a large amount of surge (solenoid type lifter, high frequency induction furnace, motor, etc.) close to the fieldbus system, this may cause deterioration or breakage of the internal circuit of the fieldbus system. Avoid sources of surge generation and crossed lines.
- When a surge-generating load such as a relay or solenoid is driven directly, use an fieldbus system with a built-in surge absorbing element.
Direct drive of a load generating surge voltage can damage the fieldbus system.
- The product is CE/UKCA marked, but not immune to lightning strikes. Take measures against lightning strikes in the system.
- Prevent foreign matter such as remnant of wires from entering the fieldbus system to avoid failure and malfunction.

- Mount the product in a place that is not exposed to excessive vibration or impact.
Otherwise failure or malfunction can result.
- Do not use the product in an environment that is exposed to temperature cycle.
Heat cycles other than ordinary changes in temperature can adversely affect the inside of the product.
- Do not expose the product to direct sunlight.
If using in a location directly exposed to sunlight, shade the product from the sunlight.
Otherwise failure or malfunction can result.
- Keep within the specified ambient temperature range.
Otherwise malfunction can result.
- Do not operate close to a heat source, or in a location exposed to radiant heat.
Otherwise malfunction can result.

*Adjustment and Operation

- Set the switches by using a sharp-pointed screwdriver etc.
It may damage set switches.
- Perform settings suitable for the operating conditions.
Incorrect setting can cause operation failure.
For details of each setting, refer to page 16 to 17 of this manual.
- Please refer to the PLC manufacturer's manual etc. for details of programming and addresses.
For the PLC protocol and programming refer to the relevant manufacturer's documentation.

*Maintenance

- Turn off the power supply, stop the supplied air, exhaust the residual pressure and verify the release of air before performing maintenance.
There is a risk of unexpected malfunction.
- Perform regular maintenance and inspections.
There is a risk of unexpected malfunction.
- After maintenance is complete, perform appropriate functional inspections.
Stop operation if the equipment does not function properly.
Otherwise safety is not assured due to an unexpected malfunction or incorrect operation.
- Do not use solvents such as benzene, thinner etc. to clean the each unit.
They could damage the surface of the body and erase the markings on the body.
Use a soft cloth to remove stains.
For heavy stains, use a cloth soaked with diluted neutral detergent and fully squeezed, then wipe up the stains again with a dry cloth.

Model Indication and How to Order

EX260-SDN 1

- Connector type, output specification

1	M12 connector, 32 outputs, PNP (negative common) / source
2	M12 connector, 32 outputs, NPN (positive common) / sink
3	M12 connector, 16 outputs, PNP (negative common) / source
4	M12 connector, 16 outputs, NPN (positive common) / sink

- Fieldbus

DN	DeviceNet®
----	------------

Summary of Product elements

<EX260-SDN1/-SDN2/-SDN3/-SDN4>

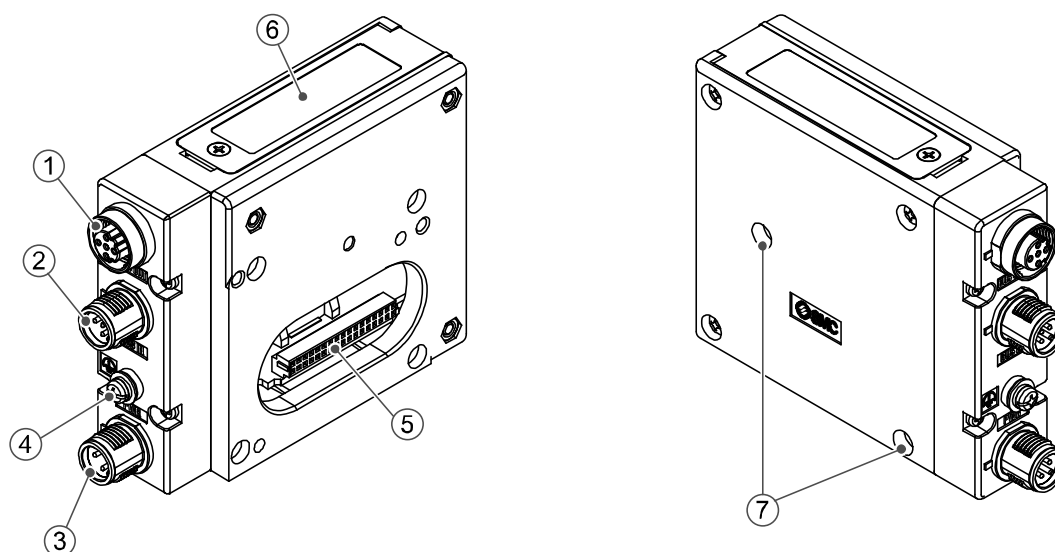

No.	Element	Description
1	Fieldbus interface connector (BUS OUT)	DeviceNet® connection. *1 (M12 5-pin socket, A-coded)
2	Fieldbus interface connector (BUS IN)	DeviceNet® connection. *1 (M12 5-pin plug A-coded)
3	Power supply connector	Power supply with load voltage for valves. *1 (M12 4-pin plug, A-coded)
4	FE terminal	Functional earth. (M3 screw)
5	Output connector	Output signal interface for valve manifold.
6	LED and switch	LED display to indicate the status of the SI unit *2 Switches for setting of node address and operating mode. *2
7	Mounting hole	Mounting hole for connection to the valve manifold.

Accessories

Hexagon socket head cap screw	2 pcs. M3 x 30 screw for connection to the valve manifold.
Seal cap	1 pc. seal cap for unused fieldbus interface connector (BUS OUT).

*1: For details of suitable cables refer to the Accessories section on page 36.

*2: Refer to page 15 for the LED Indication and Settings.

Installation and Wiring

■ Installation

Connect valve manifold to the SI unit.

• Dimensions for installation

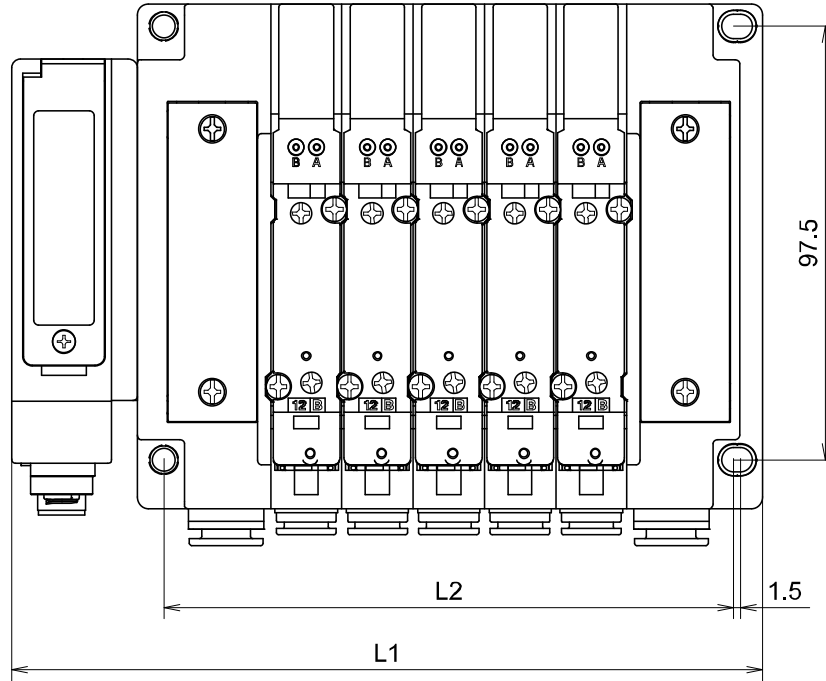

n: number of valve stations

L \ n	1	2	3	4	5	6	7	8	
L1		120.7	136.7	152.7	168.7	184.7	200.7	216.7	
L2		80	96	112	128	144	160	176	
L \ n	9	10	11	12	13	14	15	16	
L1		232.7	248.7	264.7	280.7	296.7	312.7	328.7	344.7
L2		192	208	224	240	256	272	288	304

(mm)

The above table shows dimensions as an example for the SY5000 series valve manifold. Refer to the valve manifold section in the valve catalogue for valve manifold dimensions.

■Wiring

Select the appropriate cables to mate with the connectors mounted on the SI unit.
Refer to Accessories (page 36).

○Fieldbus interface connector layout

The bus connector layout for DeviceNet® is as follows.

BUS OUT: M12 5-pin socket, A-coded (SPEEDCON)

BUS IN: M12 5-pin plug, A-coded (SPEEDCON)

No.	Designation	Contact layout	
		BUS IN	BUS OUT
1	DRAIN		
2	V+		
3	V-		
4	CAN_H		
5	CAN_L		

The M12 connector cable has two types, SPEEDCON compatible and non-compatible. If both plug and socket sides have connectors for SPEEDCON, the cable can be inserted and connected by turning it a 1/2 of a rotation, leading to reduction in work hour.

A non-compatible connector can be connected to a compatible connector as well as an M12.

The BUS IN and BUS OUT communication connectors are connected inside the SI unit as shown in the circuit diagram below.

The DeviceNet® BUS OUT connector is provided as an option and can be used to connect subsequent slaves to the network.

*: It is possible to connect to the next SI unit using the BUS OUT connector; however this is not recommended in the DeviceNet® specifications. A DeviCE/Net® tap and drop cable is the preferred option.

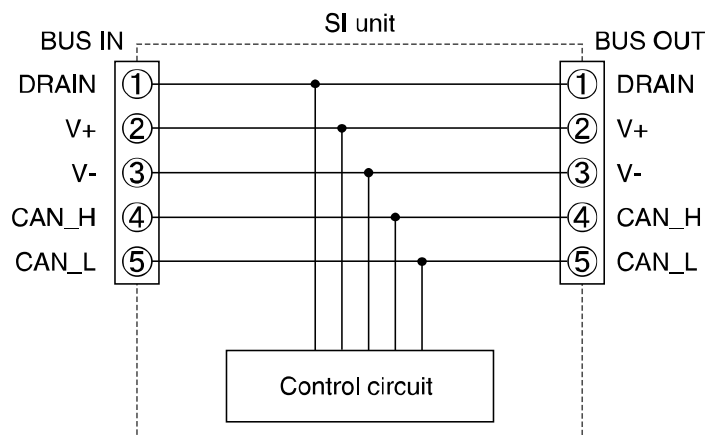

Note

- Connect terminating resistors to both ends of the DeviceNet® trunk line.
- Be sure to fit a seal cap on any unused connectors.
Proper use of the seal cap enables the enclosure to achieve IP67 specification.

*: Refer to page 37 for the seal cap.

○DeviceNet® communication cable

A shielded twisted pair cable for DeviceNet® should be used.

The max. cable length depends on the transmission speed and the cable type used.

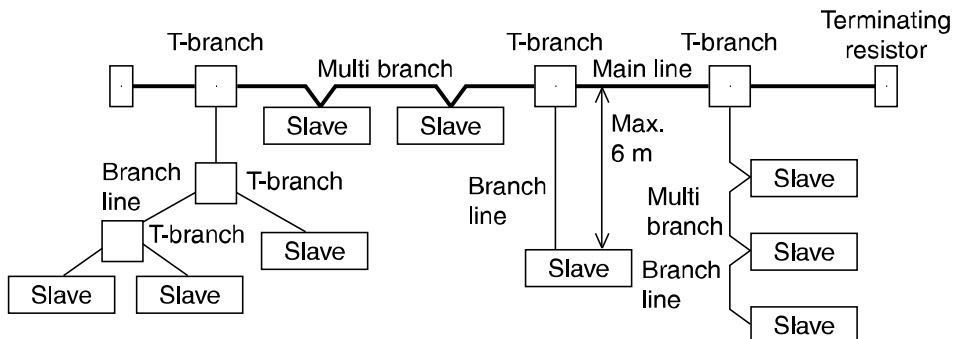

<DeviceNet® bus cable specification>

Item	Thick line		Thin line	
	Signal	Power	Signal	Power
Conductor area	0.82 mm ²	1.65 mm ²	0.20 mm ²	0.33 mm ²
Color	Blue, White	Red, Black	Blue, White	Red, Black
Impedance	120 Ω ±10% (1 MHz)	-	120 Ω ±10% (1 MHz)	-
Propagation delay	1.36 ns/ft (max.)	-	1.36 ns/ft (max.)	-
Attenuation rate	0.13 db / 100 ft@125 KHz (max.) 0.25 db / 100 ft@500 KHz (max.) 0.36 db / 100 ft@1 MHz (max.)	-	0.29 db / 100 ft@125 KHz (max.) 0.50 db / 100 ft@500 KHz (max.) 0.70 db / 100 ft@1 MHz (max.)	-
Conductor resistance	6.9 Ω / 1000 ft (max.)	3.6 Ω / 1000 ft (max.)	28 Ω / 1000 ft (max.)	17.5 Ω / 1000 ft (max.)

<Transmission speed [kbps] and max. bus cable length>

Bus cable type	Baud rate	Total main line length	Branch line length	Total main and branch line length
Thick	500 kbps	100 m max.	6 m max.	39 m max.
	250 kbps	250 m max.		78 m max.
	125 kbps	500 m max.		156 m max.
Thin	Common	100 m max.	-	-
Terminating resistor		121 Ω / (1/2 W)		

○Power supply connector layout

The power supply connector for the solenoid valve voltage is as follows.

PWR: M12 4-pin plug, A-coded (SPEEDCON)

No.	Designation	Contact layout
1	-	
2	+24 V for solenoid valve	
3	-	
4	0 V for solenoid valve	

*: Recommended mating M12 5-pin socket, part no. EX500-AP0#0-# and PCA-1401804. (Refer to page 39)

The M12 connector cable has two types, SPEEDCON compatible and non-compatible. If both plug and socket sides have connectors for SPEEDCON, the cable can be inserted and connected by turning it a 1/2 of a rotation, leading to reduction in work hour.

A non-compatible connector can be connected to a compatible connector as well as an M12.

Power-supply line for solenoid valve and power-supply line for SI unit operation are isolated.

Be sure to supply power, respectively.

Either single-source power or two different power supplies can be used.

A. Dual power supply

Current consumption of controller
power supply BUS IN

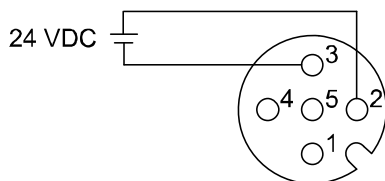

Solenoid valve
power supply

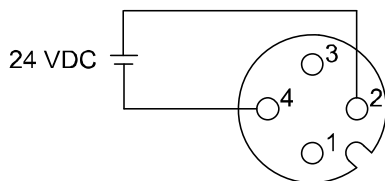

B. Single power supply

Current consumption of controller
power supply BUS IN

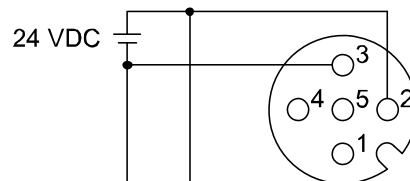

Solenoid valve
power supply

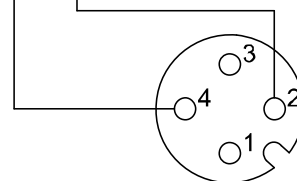

*: Pay attention not to exceed the tolerance range of power supply voltage.

○FE terminal

Connect the FE terminal to ground.

Resistance to ground should be 100 ohms or less.

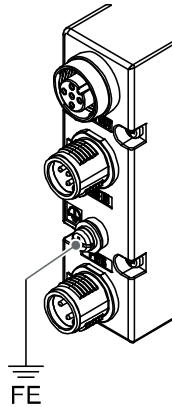

LED Indication and Settings

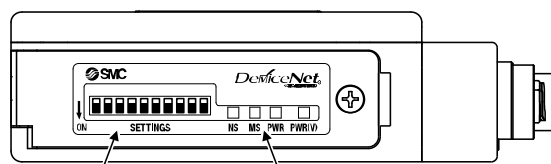

Switch for setting of the address and the baud rate

LED indication

oLED indication

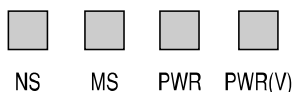

LED	Description
NS	Network status. (See the table below for details)
MS	SI unit status. (See the table below for details)
PWR	Turns ON in green when network power is supplied.
PWR(V)	Turns ON in green when load voltage for the valve is supplied. Turns OFF when load voltage for the valve is not supplied or outside tolerance range. (19 V or less)

NS status	MS status	Description
<input checked="" type="checkbox"/> Green ON	<input checked="" type="checkbox"/> Green ON	On-line status, The device has connections in the established state.
<input type="checkbox"/> OFF	<input checked="" type="checkbox"/> Green ON	Off-line status, The device has not completed the Dup_MAC ID test yet.
<input checked="" type="checkbox"/> Green flashing	<input checked="" type="checkbox"/> Green ON	On-line status, The device has no connections in the established state.
<input type="checkbox"/> OFF	<input checked="" type="checkbox"/> Red ON	Off-line status, Watchdog timer error.
<input type="checkbox"/> OFF	<input checked="" type="checkbox"/> Red flashing	Wrong switch setting, Parameter writing error.
<input checked="" type="checkbox"/> Red ON	<input checked="" type="checkbox"/> Green ON	Bus-off status, Duplicate MAC ID.
<input checked="" type="checkbox"/> Red flashing	<input checked="" type="checkbox"/> Green ON	I/O Connection is in the Timed-Out state.
<input type="checkbox"/> OFF	<input type="checkbox"/> OFF	No network power present.

○Switch setting

Set the DeviceNet® node address (MAC ID), DeviceNet® communication speed and fail safe mode, i.e. reaction of outputs to the communication error, of the SI unit using the 10-element switch.

Note

1. To set with switch, use a small blade screwdriver to flip the switches
2. Be sure to switch off the power before setting the switches.
3. Be sure to set with the switch before use.

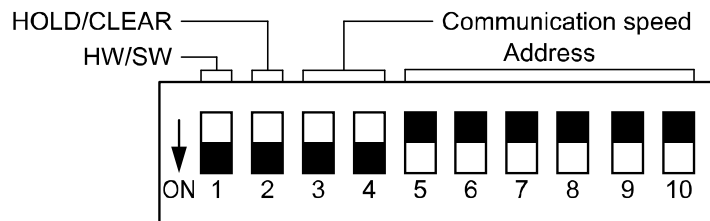

•Address setting (switch No. 5 to 10)

The DeviceNet® address (MAC ID) is binary coded and can be set from 0 to 63.

*: Factory default setting is 63.

0: OFF 1: ON

Switch No.	No.5	No.6	No.7	No.8	No.9	No.10
	32	16	8	4	2	1
MAC ID	0	0	0	0	0	0
	1	0	0	0	0	1
	2	0	0	0	1	0
	:	:	:	:	:	:
	62	1	1	1	1	0
	63	1	1	1	1	1

•Communication speed setting (switches No. 3 to 4)

The DeviceNet® communication speed is binary coded and can be set to 125 kbps, 250 kbps and 500 kbps.

*: Factory default setting is 125 kbps.

0: OFF 1: ON

Switch No.	No.3	No.4	
Communication speed	125 kbps	0	0
	250 kbps	0	1
	500 kbps	1	0
	-	1	1

•HOLD/CLEAR setting (switch No.2)

Set the reaction of outputs to the communication error. (All outputs will be set under the same conditions)

*: Factory default setting is CLEAR.

0: OFF 1: ON

Switch No.	No.2	Description	
HOLD/CLEAR	CLEAR	0	Clear all outputs.
	HOLD	1	Hold the last state before communication error.

*: Each output can be set individually over the network.

•HW/SW mode setting (switch No.1)

Modifications to the address and speed can be made locally or over the network.

Local setting: Hardware mode (referred to as "HW mode")

Network setting: Software mode (referred to as "SW mode")

*: Factory default setting is "HW mode".

0: OFF 1: ON

Switch No.		No.1	Description
HW/SW	HW	0	Set the address and speed locally using the SI unit switches.
	SW	1	Set the address and speed over the DeviceNet® network. * (Switch setting is invalid)

*: Refer to Setting over the DeviceNet® network section for the setting method through the network.

○Setting over the DeviceNet® network

The DeviceNet® node address (MAC ID), DeviceNet® communication speed and fail safe mode, i.e. reaction of outputs to the communication error, of the SI unit can be set over the DeviceNet® network in accordance with the procedure below.

•Node address setting, communication speed setting

1) Set the switch No. 1 of the 10-element switch to ON (SW mode).

2) Change the instance/attribute value in the DeviceNet® Class as follows.

Class	Instance	attribute	Description	Value
03h (DeviceNet®)	01h	01h	MAC ID (Node address)	0 to 63
	01h	02h	Baud_Rate (Communication speed)	0: 125 kbps 1: 250 kbps 2: 500 kbps

*: The MAC ID and communication speed set by SW mode on the SI unit will be saved and still valid after the DeviceNet® has been switched off.

When DeviceNet® power is applied to the SI unit in HW mode, the MAC ID and communication speed set by Software mode is no longer valid and the switch setting is valid instead.

•Setting of the reaction of outputs to the communication error

1) Set the value of the following instance/ attribute to 1.

Class	Instance	attribute	Description	Value
64h (SMC)	01h	68h	Hold Clear Timeout	0: Switch setting valid
				1: EEPROM set value Valid

2) Set the fault action and fault values in the following instances.

There are two types of fault setting method, one is the individual setting per point with the Discrete Output Point (DOP) Object and the other is the batch setting with Assembly Object.

Individual setting per point:

Fault setting	Class	Instance	Description	Value
Fault action	09h (DOP)	n (Output number + 1)	05h	0: Fault value 1: Output held
Fault value			06h	0: CLEAR 1: SET

*: For details, refer to the DeviceNet[®] Objects section.

Batch setting for all outputs:

Fault setting	Class	Instance	Description	Value
Fault action	04h (Assembly)	66h	03h	0: Fault value 1: Output held
Fault value		65h	03h	0: CLEAR 1: SET

*: For details, refer to the DeviceNet[®] Objects section.

○Diagnostic information

The status of the load voltage for the valve is mapped in the input data using the vendor specific area of the Assembly Object instance

*: For details about Assembly Object, refer to the DeviceNet[®] Objects section.

Function	Description
Valve power supply voltage monitoring	Check if the load power for the valve is not supplied or outside tolerance range. (19V or less)

Data format of the diagnostic information is as follows. (Other than bit 2, the value is always fixed to zero)

Assembly Object Instance Data format (vendor specific)

ID	Byte offset	Bit							
		7	6	5	4	3	2	1	0
105 (Diagnostic Status)	+0	0	0	0	0	0	X	0	0

SOLV Status
 0: Valve power supply voltage is normal
 1: Valve power supply voltage is abnormal

○Output number assignment
Output data

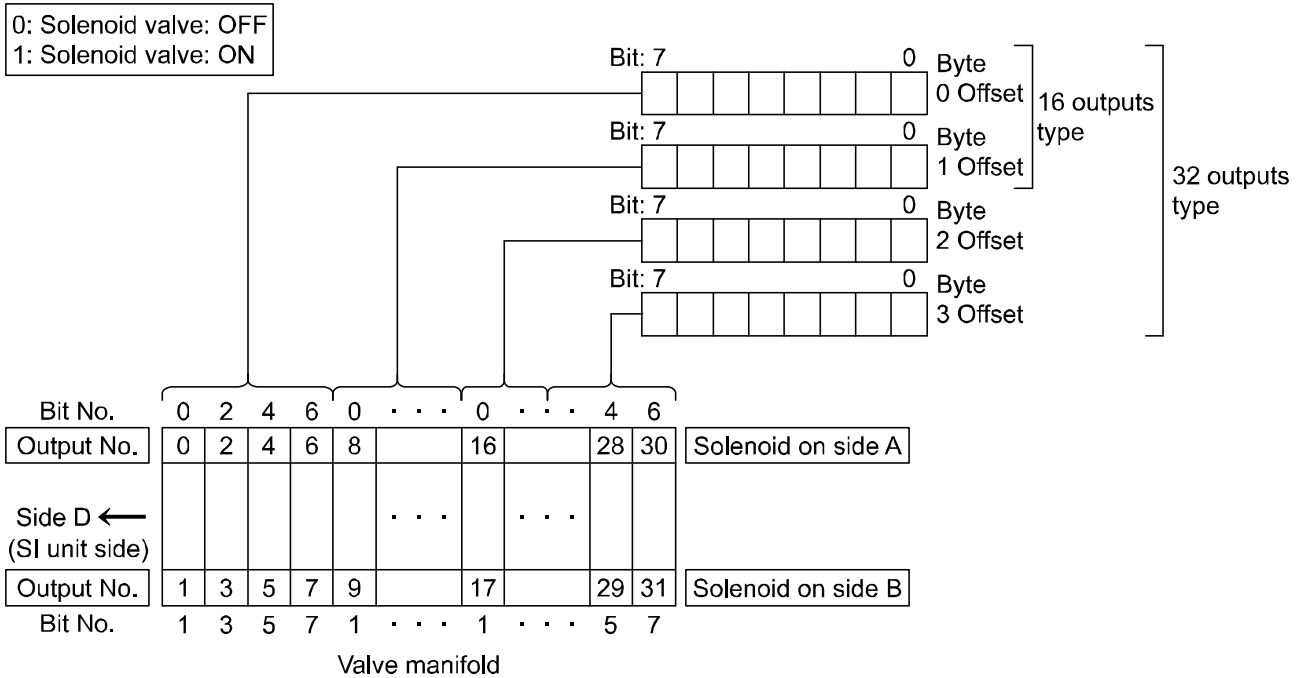

- *: The output number refers to the solenoid position on the manifold and starts at zero.
- *: Standard wiring on the manifold is for double-solenoid valves and output number starts A side and B side in that order as shown in the figure a.
If you mount a single-solenoid valve on the standard wiring manifold, output number for B side valve is skipped.
- *: Custom wiring for mixed mounting single-solenoid valves and double-solenoid-valves can be specified with a Wiring Specification Sheet. Example wiring is shown in the figure b.
- *: Bit status "0" and "1" on a data corresponds solenoid valve status ON and OFF (0: OFF, 1: ON), and output number starts at zero from LSB (least significant bit).

fig.a

	No.	Station	No.
Double	4	3	5
Single	2	2	3 free
Double	0	1	1

fig.b

	No.	Station	No.
Double	3	3	4
Single	2	2	-
Double	0	1	1

DeviceNet® Objects

EX260 SI unit supports the following DeviceNet® object classes and device type is Pneumatic Valves.

*: xxh means hexadecimal number.

Class code	Object class
01h	Identity
02h	Message Router
03h	DeviceNet®
04h	Assembly
05h	DeviceNet® Connection
09h	Discrete Output Point
0Fh	Parameter
64h	SMC SI (SMC Specific)

1. Identity Object (Class ID: 01h)

1-1. Class attribute

ID	Access rule	Description	Value
-	-	-	-

1-2. Class common service

Service code	Service name
-	-

1-3. Instance attribute

ID	Access rule	Description	Value
1	Get	Vender ID	07h
2	Get	Device Type	1Bh
3	Get	Product Code	*1
4	Get	Revision	Per unit
5	Get	Status	-
6	Get	Serial Number	Per unit
7	Get	Product Name	*1

*1: The table below shows the product codes and product names corresponding to the SI unit type.

SI unit	Product Code	Product Name (ASCII)
EX260-SDN1	92h	EX260-SDN1
EX260-SDN2	98h	EX260-SDN2
EX260-SDN3	96h	EX260-SDN3
EX260-SDN4	99h	EX260-SDN4

1-4. Instance common service

Service code	Description
05h	Reset
0Eh	Get_Attribute_Single

1-5. Specific service

None.

2. Message Router Object (Class ID: 02h)

2-1. Class attribute

ID	Access rule	Description	Value
-	-	-	-

2-2. Class common service

Service code	Description
-	-

2-3. Instance attribute

ID	Access rule	Description	Value
-	-	-	-

2-4. Instance common service

Service code	Description
-	-

2-5. Specific service

None.

3. DeviceNet® Object (Class ID: 03h)

3-1. Class attribute

ID	Access rule	Description	Value
1	Get	revision	2

3-2. Class common service

Service code	Description
0Eh	Get_Attribute_Single

3-3. Instance attribute

ID	Access rule	Description	Value
1	Get/Set *1	MAC ID	0-63
2	Get/Set *1	Baud Rate	0-2
3	Get/Set	Bus Off Interrupt (BOI)	0-1
4	Get/Set	Bus Off Counter	0-255
5	Get	Allocation Information	-
6	Get	MAC ID Switch Changed	0-1
7	Get	Baud Rate Switch Changed	0-1
8	Get	MAC ID Switch Value	0-63
9	Get	Baud Rate Switch Value	0-2
10	Set	Quick Connect	0-1

*1: "Set" is available in SW mode.

3-4. Instance common service

Service code	Description
0Eh	Get_Attribute_Single
10h	Set_Attribute_Single

3-5. Specific service

Service code	Description
4Bh	Allocate_Master/Slave_Connection_set
4Ch	Release_Group_2_Identifier_Set

4. Assembly Object (Class ID: 04h)

4-1. Class attribute

ID	Access rule	Description	Value
1	Get	revision	2

4-2. Class common service

Service code	Service name
-	-

4-3. Instance attribute

ID	Access rule	Description
3	Get/Set *1	Data

*1: If the instance type is input, the access rule will be Get.

4-4. Solenoid Output Assembly Instance

ID	Type	Description	Byte
35	Output	16 Solenoid Output Points	2
37	Output	32 Solenoid Output Points	4

The data format is shown below.

ID	Byte offset	Data							
		bit7				bit0			
35	+0	OUT7	OUT6	OUT5	OUT4	OUT3	OUT2	OUT1	OUT0
	+1	OUT15	OUT14	OUT13	OUT12	OUT11	OUT10	OUT9	OUT8
37	+0	OUT7	OUT6	OUT5	OUT4	OUT3	OUT2	OUT1	OUT0
	+1	OUT15	OUT14	OUT13	OUT12	OUT11	OUT10	OUT9	OUT8
	+2	OUT23	OUT22	OUT21	OUT20	OUT19	OUT18	OUT17	OUT16
	+3	OUT31	OUT30	OUT29	OUT28	OUT27	OUT26	OUT25	OUT24

4-5. Vendor specific instance (Fault/Idle package setting/ diagnostic data)

ID	Type	Description	Byte
101	Output	Discrete Output Point Fault Value	4 *1
102	Output	Discrete Output Point Fault Action	4 *1
103	Output	Discrete Output Point Idle Value	4 *1
104	Output	Discrete Output Point Idle Action	4 *1
105	Input	Diagnostic Status	1 *2

*1: Regardless of the setting of the solenoid output assembly, the number of bytes will be 4.

For 16-output, the last 2 bytes will be dummy values.

*2: For information about "Diagnostic Status", refer to "Diagnostic information" on page 18 of this operation manual.

The data format is shown below.

ID	Byte offset	Data							
		bit7				bit0			
101	+0	FV7	FV6	FV5	FV4	FV3	FV2	FV1	FV0
	+1	FV15	FV14	FV13	FV12	FV11	FV10	FV9	FV8
	+2	FV23	FV22	FV21	FV20	FV19	FV18	FV17	FV16
	+3	FV31	FV30	FV29	FV28	FV27	FV26	FV25	FV24
102	+0	FA7	FA6	FA5	FA4	FA3	FA2	FA1	FA0
	+1	FA15	FA14	FA13	FA12	FA11	FA10	FA9	FA8
	+2	FA23	FA22	FA21	FA20	FA19	FA18	FA17	FA16
	+3	FA31	FA30	FA29	FA28	FA27	FA26	FA25	FA24
103	+0	IV7	IV6	IV5	IV4	IV3	IV2	IV1	IV0
	+1	IV15	IV14	IV13	IV12	IV11	IV10	IV9	IV8
	+2	IV23	IV22	IV21	IV20	IV19	IV18	IV17	IV16
	+3	IV31	IV30	IV29	IV28	IV27	IV26	IV25	IV24
104	+0	IA7	IA6	IA5	IA4	IA3	IA2	IA1	IA0
	+1	IA15	IA14	IA13	IA12	IA11	IA10	IA9	IA8
	+2	IA23	IA22	IA21	IA20	IA19	IA18	IA17	IA16
	+3	IA31	IA30	IA29	IA28	IA27	IA26	IA25	IA24
105	+0	0	0	0	0	0	SOLV	0	0

*: FV: Fault Value, FA: Fault Action, IV: Idle Value, IA: Idle Action.

4-6. Instance common service

Service code	Description
0Eh	Get_Attribute_Single
10h	Set_Attribute_Single

4-7. Specific service

None.

5. DeviceNet® Connection Object (Class ID: 05h)

5-1. Class attribute

ID	Access rule	Description	Value
-	-	-	-

5-2. Class common service

Service code	Description
-	-

5-3. Instance attribute1 (Explicit message)

ID	Access rule	Description	Value
1	Get	State	03h
2	Get	Instance_type	00h
3	Get	TransportClass_trigger	83h
4	Get	DeviceNet®_produced_connection_id	-
5	Get	DeviceNet®_consumed_connection_id	-
6	Get	DeviceNet®_initial_comm_characteristics	21h
7	Get	Produced_connection_size	FFFFh
8	Get	Consumed_connection_size	FFFFh
9	Get/Set	Expected_packet_rate	-
12	Get/Set	Watchdog_timeout_action	-
13	Get	Produced_connection_path_length	0
14	Get	Produced_connection_path	None
15	Get	Consumed_connection_path_length	0
16	Get	Consumed_connection_path	None
17	Get	Production_inhibit_time	0

5-4. Instance attribute2 (I/O: Poll message)

ID	Access rule	Description	Value
1	Get	State	01h
2	Get	Instance_type	01h
3	Get	TransportClass_trigger	82h
4	Get	DeviceNet®_produced_connection_id	-
5	Get	DeviceNet®_consumed_connection_id	-
6	Get	DeviceNet®_initial_comm_characteristics	01h
7	Get	Produced_connection_size	00h
8	Get	Consumed_connection_size	04 h: EX260-SDN1, EX260-SDN2 02 h: EX260-SDN3, EX260-SDN4
9	Get/Set	Expected_packet_rate	-
12	Get/Set	Watchdog_timeout_action	-
13	Get	Produced_connection_path_length	0
14	Get	Produced_connection_path	None
15	Get	Consumed_connection_path_length	6
16	Get	Consumed_connection_path	20h 04h 24h xxh 30h 03h xx can be either 25 or 23 25: EX260-SDN1, EX260-SDN2 23: EX260-SDN3, EX260-SDN4
17	Get	Production_inhibit_time	0

5-5. Instance common service

Service code	Description
0Eh	Get_Attribute_Single
10h	Set_Attribute_Single

6. Discrete Output Point Object (Class ID: 09h)

6-1. Class attribute

ID	Access rule	Description	Value
2	Get	Max Instance	32

6-2. Class common service

Service code	Description
0Eh	Get_Attribute_Single

6-3. Instance attribute

ID	Access rule	Description	Value
3	Get/Set	Value	0: OFF 1: ON
4	Get	Status	0: OK 1: Check valve power supply
5	Get/Set *1	Fault Action	0: Fault value 1: Output held
6	Get/Set *1	Fault Value	0: CLEAR 1: SET
7	Get/Set *1	Idle Action	0: Idle value 1: Output held
8	Get/Set *1	Idle Value	0: CLEAR 1: SET

*1: Hold the data in EEPROM.

6-4. Instance common service

Service code	Description
0Eh	Get_Attribute_Single
10h	Set_Attribute_Single

6-5 Specific service

None.

7. Parameter Object (Class ID: 0Fh)

7-1. Class attribute

ID	Access rule	Description	Value
2	Get	Max Instance	4
8	Get	Parameter Class Descriptor	9
9	Get	Configuration Assembly Instance	0

7-2. Class common service

Service code	Description
0Eh	Get_Attribute_Single

7-3. Instance attribute1: SOLV Status

ID	Access rule	Description	Value
1	Get	Parameter Value	0: Valve power supply voltage is normal 1: Valve power supply voltage is abnormal
2	Get	Link Path Size	6
3	Get	Link Path	20h 64h 24h 01h 30h 64h
4	Get	Descriptor	3Ch
5	Get	Data Type	C1h
6	Get	Data Size	1

7-4. Instance attribute2: SOLV Fuse Status

ID	Access rule	Description	Value
1	Get	Parameter Value	0: Valve power supply fuse is normal 1: Valve power supply fuse is broken *1
2	Get	Link Path Size	6
3	Get	Link Path	20h 64h 24h 01h 30h 65h
4	Get	Descriptor	3Ch
5	Get	Data Type	C1h
6	Get	Data Size	1

*1: This product does not have a function that monitors the valve power supply fuse. The value is always 0.

7-5. Instance attribute3: Hold Clear Timeout

ID	Access rule	Description	Value
1	Get/Set	Parameter Value	0: DIP-SW valid 1: EEPROM valid
2	Get	Link Path Size	6
3	Get	Link Path	20h 64h 24h 01h 30h 68h
4	Get	Descriptor	0Ch
5	Get	Data Type	C1h
6	Get	Data Size	1

7-6. Instance attribute4: EEPROM Status

ID	Access rule	Description	Value
1	Get	Parameter Value	0: Normal 1: There is a check sum error. 2: Error related to previous write cycle
2	Get	Link Path Size	6
3	Get	Link Path	20h 64h 24h 01h 30h 6Dh
4	Get	Descriptor	3Ch
5	Get	Data Type	C6h
6	Get	Data Size	1

7-7. Instance common service

Service code	Description
0Eh	Get_Attribute_Single
10h	Set_Attribute_Single

8. SMC SI Object (Class ID: 64h)

8-1. Class attribute

ID	Access rule	Description	Value
-	-	-	-

8-2. Class common service

Service code	Service name
-	-

8-3. Instance attribute

ID	Access rule	Description	Value
100	Get	SOLV Status	0: Valve power supply voltage is normal 1: Valve power supply voltage is abnormal
101	Get	SOLV Fuse Status	0: Valve power supply fuse is normal 1: Valve power supply fuse is broken *1
104	Get/Set	Hold Clear Timeout	0: DIP-SW valid (Default) 1: EEPROM valid
109	Get	EEPROM Status	0: Normal (Default) 1: There is a check sum error 2: Error related to previous write cycle

*1: This product does not have a function that monitors the valve power supply fuse. The value is always 0.

8-4. Instance common service

Service code	Description
0Eh	Get_Attribute_Single
10h	Set_Attribute_Single

8-5. Specific service

None.

Troubleshooting and Maintenance

○ Troubleshooting chart

When any malfunction is observed, it is recommended to perform the following troubleshooting.

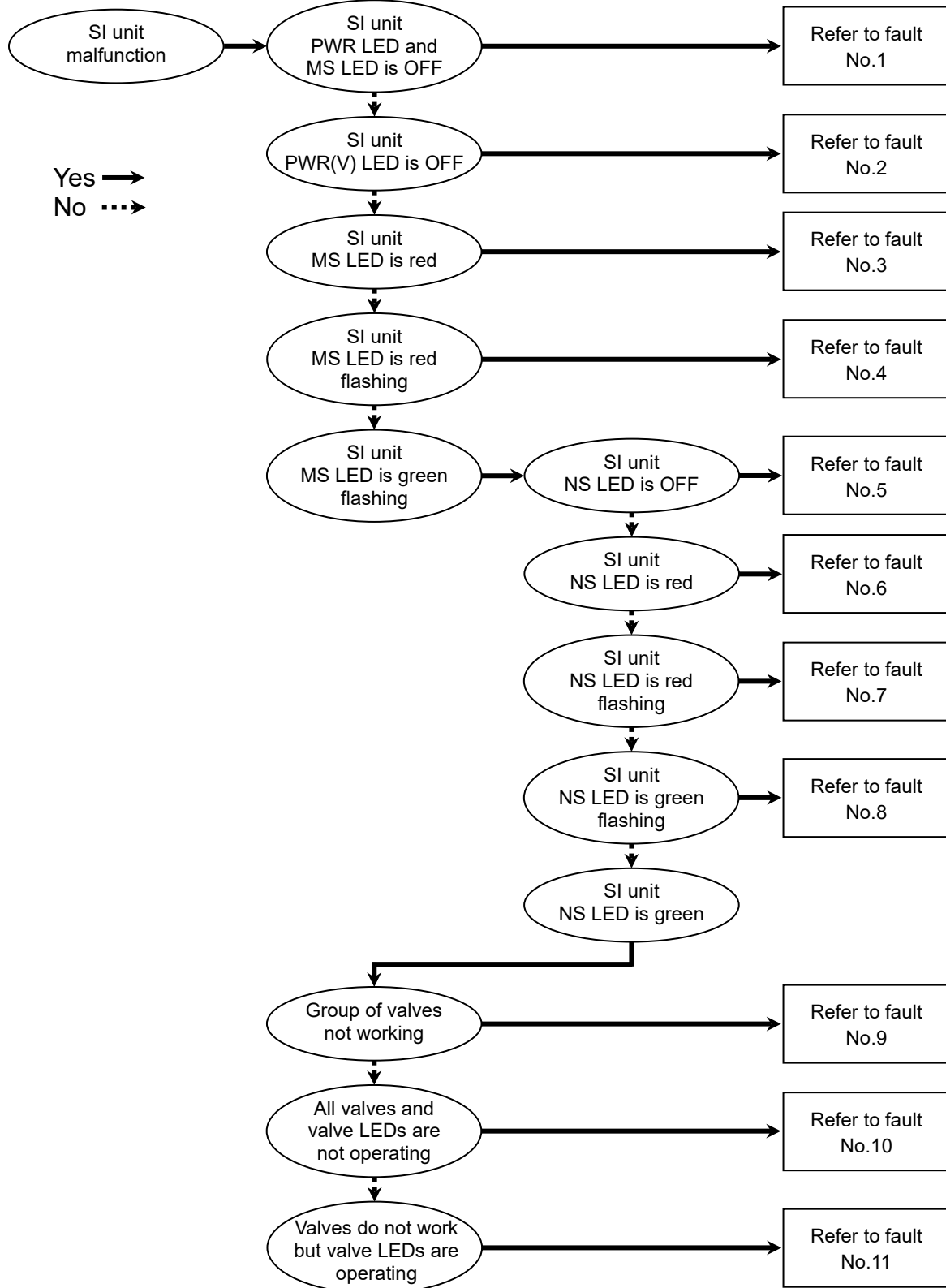

Troubleshooting table

Fault No.1

Fault	Probable cause	Recommended error handling	Recommended action
SI unit PWR LED and MS LED is OFF	Defective DeviceNet® cable	Check the DeviceNet® cable connection.	Re-tighten the DeviceNet® cable. (Replace the cable if it is broken)
	DeviceNet® power is not supplied	Check the DeviceNet® power.	Correct the DeviceNet® power wiring layout. Supply 11 to 25 VDC to the DeviceNet® power.

Fault No.2

Fault	Probable cause	Recommended error handling	Recommended action
SI unit PWR(V) LED is OFF	Defective power cable wiring for the solenoid valve	Check the condition of the power cable wiring for the valve.	Re-tighten the power cable. (Replace the cable if it is broken)
	Load voltage for the valve is not supplied	Check the condition of the supply voltage for the valve.	Correct the power cable wiring layout. Supply 24 VDC +10%/-5% to the valve.

Fault No.3

Fault	Probable cause	Recommended error handling	Recommended action
SI unit MS LED is red	SI unit fault	SI unit is damaged.	Replace the SI unit.

Fault No.4

Fault	Probable cause	Recommended error handling	Recommended action
SI unit MS LED is red flashing	EEPROM error	EEPROM writing error.	Send the reset service to reset the SI unit. (Sending data: Service code 5, class ID 1, instance 1, value 1)
	Invalid switch setting	Check if the switch setting for MAC ID or communication speed switch has been changed while the unit power is ON.	Change the address communication speed switch with the unit power off.

Fault No.5

Fault	Probable cause	Recommended error handling	Recommended action
SI unit MS LED is green and NS LED is OFF	DeviceNet® master malfunction	Check the condition of the DeviceNet® master.	Refer to the Operation Manual of the DeviceNet® master.

Fault No.6

Fault	Probable cause	Recommended error handling	Recommended action
SI unit MS LED is green, and NS LED is red	Duplicate MAC ID	Check the MAC ID is not duplicated with the other slave units.	Set MAC ID to the SI unit correctly.
	Bus off detection	Check if the communication speed setting on the SI unit matches the speed setting on the DeviceNet® master.	Set same speed setting with DeviceNet® master.
		Check if the DeviceNet® cable length is within specification (trunk line and drop line).	Configure DeviceNet® cable as specified by DeviceNet® specification.
		Check the DeviceNet® communication cable is not broken and there is no loose connection. Check that no repetitive bending stress or pulling force is being applied to the cable.	Connect the DeviceNet® communication cable correctly.
		Check the terminating resistor (121 Ω) is installed at both ends of the trunk line.	Install the terminating resistor (121 Ω) properly.
		Check that there is no noise source or high voltage line around the DeviceNet® cables and power cables.	Keep noise sources away from DeviceNet® cables and power cables.

Fault No.7

Fault	Probable cause	Recommended error handling	Recommended action
SI unit MS LED is green, and NS LED is red flashing	Communication connection timeout	Check if the DeviceNet® cable length is within specification (trunk line and drop line).	Configure DeviceNet® cable as specified by DeviceNet® specification.
		Check the DeviceNet® communication cable is not broken and there is no loose connection. Check that no repetitive bending stress or pulling force is being applied to the cable.	Connect the DeviceNet® communication cable correctly.
		Check the terminating resistor (121 Ω) is installed at both ends of the trunk line.	Install the terminating resistor (121 Ω) properly.
		Check that there is no noise source or high voltage line around the DeviceNet® cables and power cables.	Keep noise sources away from DeviceNet® cables and power cables.

Fault No.8

Fault	Probable cause	Recommended error handling	Recommended action
SI unit MS LED is green, and NS LED is green flashing	Connection stand-by	Check the condition of DeviceNet® master. Check the I/O area of the slave unit is not over the area permitted by the master unit.	Refer to the Operation Manual of the DeviceNet® master.

Fault No.9

Fault	Probable cause	Recommended error handling	Recommended action
Group of valves not working	Too many valves	<p>Check if solenoid count does not exceed the allowable number. It depends on SI unit model and valve series.</p> <p>Allowable solenoid number by valve series: SY/SV series: 32 points VQC/S0700 series: 24 points</p>	Keep the number of mounting solenoid valves within specification.

Fault No.10

Fault	Probable cause	Recommended error handling	Recommended action
All valves and valve LEDs are not operating	Poor connection between SI unit and valve manifold	Check if there are any loose screws making the connection between the SI unit and the valve manifold.	Tighten the screws with the specified tightening torque (i.e. 0.6 N•m) and make sure there is no gap between the SI unit and the valve manifold.
	Mismatch polarity between solenoid valve and SI unit output	Check if the solenoid valve common specification matches the output polarity of the SI unit.	Match polarity between solenoid valve and SI unit output
	Defective solenoid valve	Follow the troubleshooting for the solenoid valve.	Same as left.

Fault No.11

Fault	Probable cause	Recommended error handling	Recommended action
Valves do not work but valve LEDs are operating	Mismatch polarity between solenoid valve and SI unit output	Check if the solenoid valve common specification matches the output polarity of the SI unit.	Match polarity between solenoid valve and SI unit output.

○Maintenance

Replacement of the SI unit

- Remove the M3 hexagon screws from the SI unit and release the SI unit from the valve manifold.
- Replace the SI unit.
- Tighten the screws with the specified tightening torque. (0.6 N•m)

Precautions for maintenance

- (1) Be sure to switch off the power.
- (2) Check there is no foreign matter inside the SI unit.
- (3) Check there is no damage and no foreign matter stuck to the gasket.
- (4) Be sure to tighten the screw with the specified torque

If the SI unit is not assembled properly, inside PCBs may be damaged or liquid and/or dust may enter into the unit.

○Assembly and disassembly of the SI unit

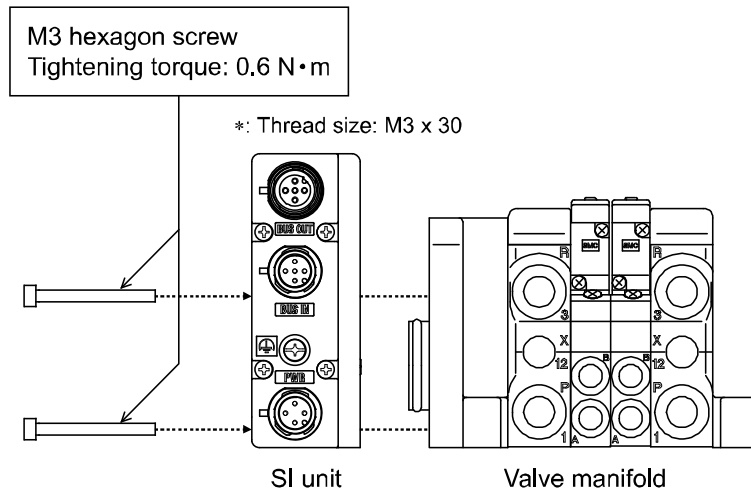

Specification

■ Specifications

General specifications

Item	Specifications
Ambient temperature	-10 to +50 °C
Ambient humidity	35 to 85%RH (No condensate)
Ambient temperature for storage	-20 to +60 °C
Withstand voltage	500 VAC applied for 1 minute
Insulation resistance	500 VDC, 10 MΩ or more
Enclosure	IP67
Weight	200 g or less
Standard	UL/CSA, CE/UKCA marked

Electrical specifications

Item		Specifications	
Current consumption in power supply voltage range	Current consumption of controller power supply	11 to 25 VDC 0.1 A max.	
	Solenoid valve power supply	22.8 to 26.4 VDC 2.0 A or less, according to the solenoid valve station specification	
Solenoid valve connecting specification	Output type	EX260-SDN1/-SDN3	PNP (negative common) / source
		EX260-SDN2/-SDN4	NPN (positive common) / sink
	Number of outputs	EX260-SDN1/-SDN2	32 outputs
		EX260-SDN3/-SDN4	16 outputs
	Connected load	Solenoid valve with surge voltage suppressor of 24 VDC and 1.5 W or less (manufactured by SMC)	
	Output setting at the time of communication error	Output HOLD/CLEAR	
	Insulation type	Photo coupler insulation type	
Residual voltage	0.4 VDC or less		

Network communication specifications

Item	Specifications
Protocol	DeviceNet® Volume 1 (Edition 3.5) Volume 3 (Edition 1.5)
Slave type	Group 2 Only Server
Device type	1Bh (Pneumatic Valve)
Product code	92h: EX260-SDN1 98h: EX260-SDN2 96h: EX260-SDN3 99h: EX260-SDN4
Vender ID	7h (SMC Corp.)
Applicable message	Duplicate MAC ID Check Message Unconnected Explicit Message Explicit Message Poll I/O Message (Predefined M/S connection set)
Node address setting range	0 to 63
Data rate	125 kbps / 250 kbps / 500 kbps
Setting file	EDS file (Please download from SMC website)
Occupied area (Number inputs / outputs)	EX260-SDN1/-SDN2: 0/32 EX260-SDN3/-SDN4: 0/16

Connectable valve series

Valve series	
SY series	SY3000, SY5000, SY7000
VQC series	VQC1000, VQC2000, VQC4000
SV series	SV1000, SV2000, SV3000 (10 type tie-rod base)
S0700 series	S0700

■Dimensions

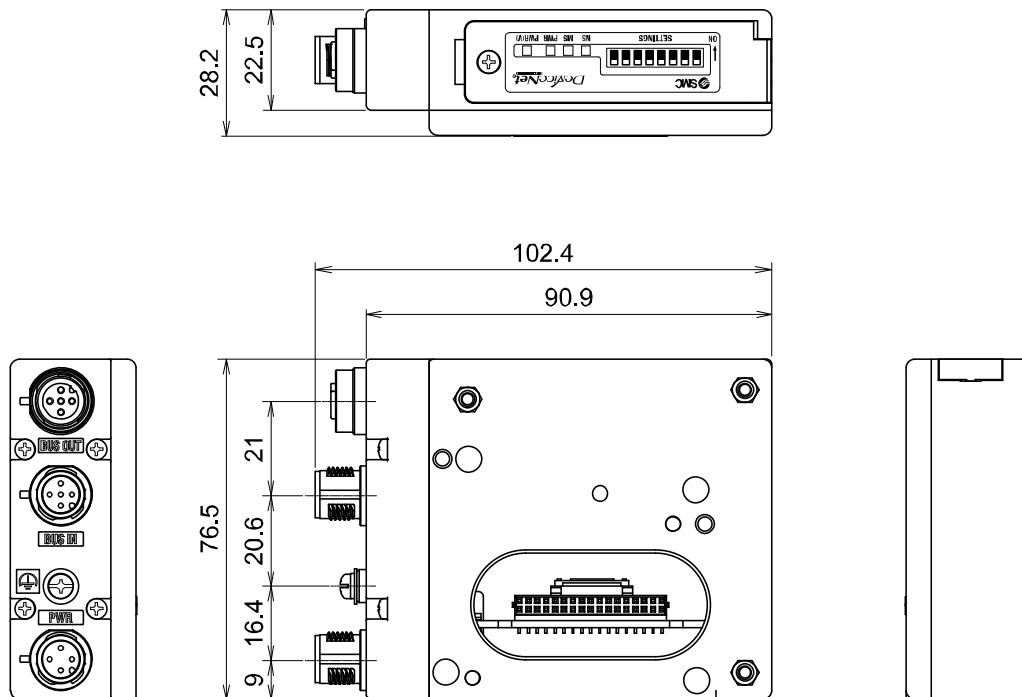

- If a fieldwireable connector is used for the power supply connection, and the SI unit is installed directly to a valve manifold, the cable connector's outer diameter should be $\phi 16$ mm or less. If it is a larger diameter, the connector will interfere with the mounting surface. Recommended cables are specified in the accessories section, on page 36.

Accessories

Fieldbus interface connector (OUT)

(1) Cable with communication connector (SPEEDCON)

Part number: PCA-1557646

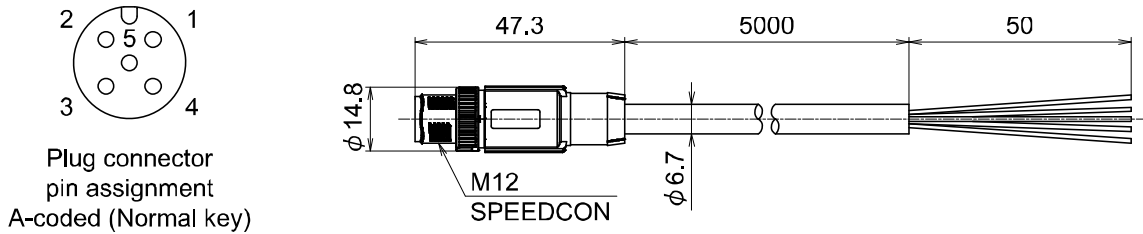

Item		Specifications
Connector		M12 Straight (SPEEDCON)
Cable length		5000 mm
Cable O.D.		φ6.7 mm
Nominal cross section	Power pair	AWG22
	Data pair	AWG24
Wire diameter (Including insulator)	Power pair	1.4 mm
	Data pair	2.05 mm
Min. bending radius (Fixed)		67 mm

Pin No.	Cable colour: Signal
1	: DRAIN
2	Red : V+
3	Black : V-
4	White: CAN H
5	Blue : CAN L

(2) Fieldwireable connector (SPEEDCON)

Part number: PCA-1075528

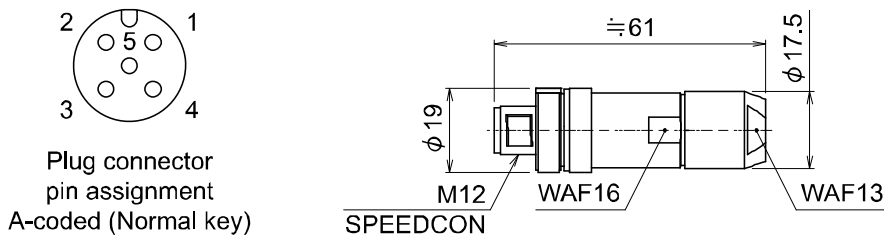

Applicable cable

Item	Specifications
Cable O.D.	φ4.0 to 8.0 mm
Electric wire cross section (Twist line)	AWG26 to 20

Pin No.	Cable colour: Signal
1	: DRAIN
2	Red : V+
3	Black : V-
4	White: CAN H
5	Blue : CAN L

(3) Terminating resistor for DeviceNet®

Part number: PCA-1557675

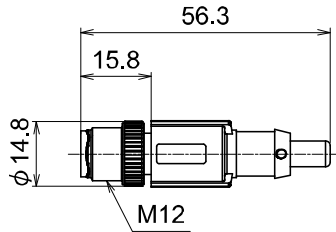
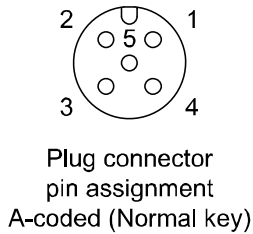

(4) Seal cap

Part number: EX9-AWTS

This cap is used to protect the M12 connector opening when the connector is not used. When the "BUS OUT" connector is not used, the seal cap can keep the SI unit under IP67 rated protection.

(One seal cap will be attached to the SI unit when shipped from factory.)

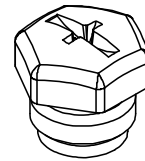

Description	Part No.	Specification
Seal cap	EX9-AWTS	For M12 connector socket: 10 pcs.

○Fieldbus interface connector (IN)

(1) Cable with communication connector (SPEEDCON)

Part number: PCA-1557633

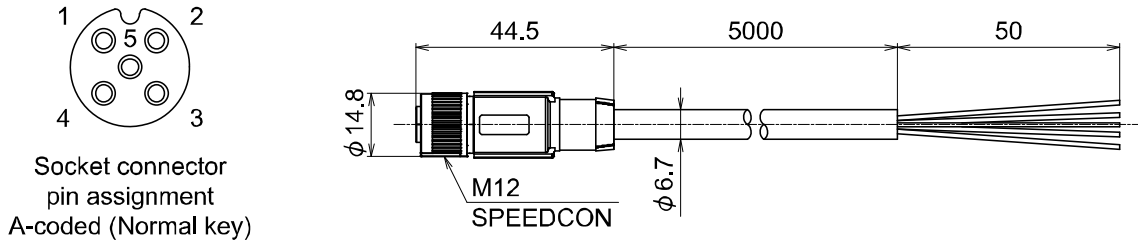

Item		Specifications
Connector		M12 Straight (SPEEDCON)
Cable length		5000 m
Cable O.D.		φ6.7 mm
Nominal cross section	Power pair	AWG22
	Data pair	AWG24
Wire diameter (Including insulator)	Power pair	1.4 mm
	Data pair	2.05 mm
Min. bending radius (Fixed)		67 mm

Pin No.	Cable colour: Signal
1	: DRAIN
2	Red : V+
3	Black : V-
4	White: CAN H
5	Blue : CAN L

(2) Fieldwireable connector (SPEEDCON)

Part number: PCA-1075529

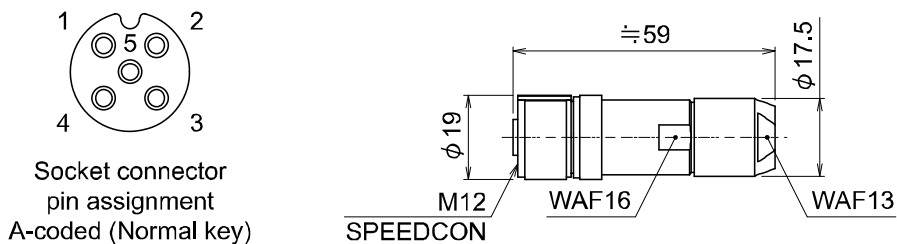

Applicable cable

Item	Specifications
Cable O.D.	φ4.0 to 8.0 mm
Electric wire cross section (Twist line)	AWG26 to 20

Pin No.	Cable colour: Signal
1	: DRAIN
2	Red : V+
3	Black : V-
4	White: CAN H
5	Blue : CAN L

○Power supply connector

(1) Cable with power supply connector

Part number: EX500-AP010-S

Connector specifications

S	Straight
A	Angle

Cable length (L)

1	1000 [mm]
5	5000 [mm]

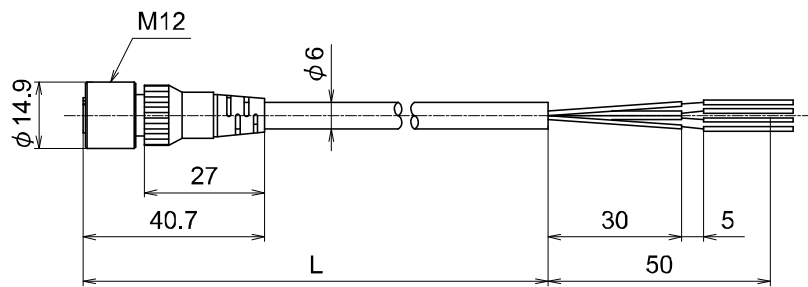

EX500-AP0#0-S

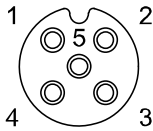

Socket connector
pin assignment
A-coded (Normal key)

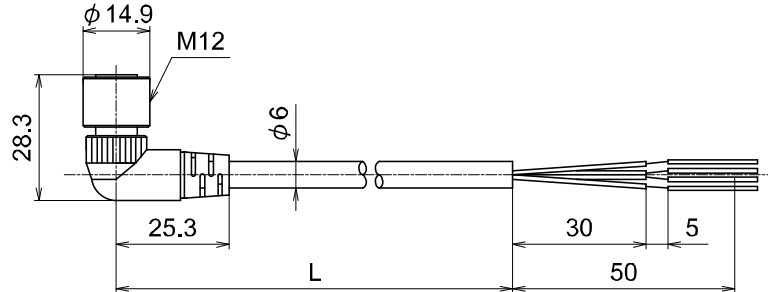

EX500-AP0#0-A

Item	Specifications
Cable O.D.	φ6 mm
Nominal cross section	AWG22
Wire diameter (Including insulator)	1.5 mm
Min. bending radius (Fixed)	40 mm

Pin No.	Cable colour: Signal
1	Brown: Not connected
2	White : 24 VDC (For solenoid valve)
3	Blue : Not connected
4	Black : 0 V(For solenoid valve)
5	Gray : Not connected

(2) Cable with power supply connector (SPEEDCON)

Part number: PCA-1401804

• Cable length (L)

4	1500 [mm]
5	3000 [mm]
6	5000 [mm]

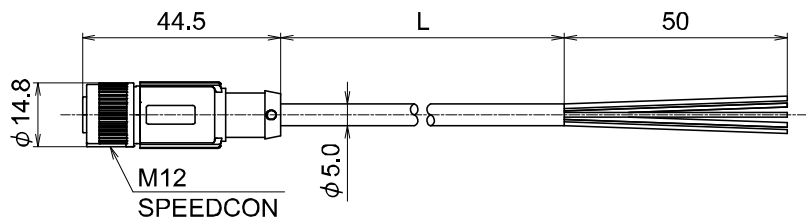
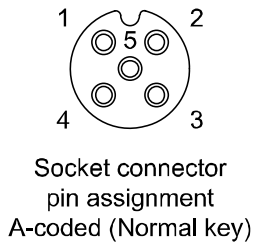

Item	Specifications
Connector	M12 Straight (SPEEDCON)
Cable O.D.	$\phi 5$ mm
Nominal cross section	AWG22
Wire diameter (Including insulator)	1.27 mm
Min. bending radius (Fixed)	21.7 mm

Pin No.	Cable colour: Signal
1	Brown: Not connected
2	White : 24 VDC (For solenoid valve)
3	Blue : Not connected
4	Black : 0 V (For solenoid valve)
5	Green/Yellow: Not connected

Revision history

A: Revise some wording.
B: Revision.
C: Revision.
D: Limited warranty and Disclaimer are added.
E: Modified errors in text.
F: Revision.
G: Contents are added. [July 2016]
H: Contents revised in several places.
[December 2021]
I: Contents are added. [June 2022]
J: Contents revised in several places [May 2024]

SMC Corporation

Tel: + 81 3 5207 8249 Fax: +81 3 5298 5362

URL <https://www.smcworld.com>

Note: Specifications are subject to change without prior notice and any obligation on the part of the manufacturer.
© SMC Corporation All Rights Reserved

