



Operation Manual

PRODUCT NAME

SI unit
(☑ IO-Link device)

MODEL / Series / Product Number

EX260-SIL1

SMC Corporation

Table of Contents

Safety Instructions	2
Model Indication and How to Order	8
Summary of Product elements	9
Summary of product function	10
Installation and Wiring	11
Installation	11
Wiring	12
LED Indication, Settings and State Monitoring	13
LED indication	13
Switch setting (Process data size / Data transmission rate setting)	13
Parameter settings and state monitoring	14
IODD file	14
Data Storage	14
Parameter data	14
Output number layout / Process data	23
Input number layout / Process data	26
Troubleshooting and Maintenance	27
Specification	32
Specifications	32
Dimensions	34



Safety Instructions

These safety instructions are intended to prevent hazardous situations and/or equipment damage. These instructions indicate the level of potential hazard with the labels of “**Caution**,” “**Warning**” or “**Danger**.” They are all important notes for safety and must be followed in addition to International Standards (ISO/IEC)^{*1}, and other safety regulations.

*1) ISO 4414: Pneumatic fluid power - General rules and safety requirements for systems and their components
ISO 4413: Hydraulic fluid power - General rules and safety requirements for systems and their components
IEC 60204-1: Safety of machinery - Electrical equipment of machines - Part 1: General requirements
ISO 10218-1: Robots and robotic devices - Safety requirements for industrial robots - Part 1: Robots
etc.

	Danger	Danger indicates a hazard with a high level of risk which, if not avoided, will result in death or serious injury.
	Warning	Warning indicates a hazard with a medium level of risk which, if not avoided, could result in death or serious injury.
	Caution	Caution indicates a hazard with a low level of risk which, if not avoided, could result in minor or moderate injury.

Warning

- 1. The compatibility of the product is the responsibility of the person who designs the equipment or decides its specifications.**
Since the product specified here is used under various operating conditions, its compatibility with specific equipment must be decided by the person who designs the equipment or decides its specifications based on necessary analysis and test results. The expected performance and safety assurance of the equipment will be the responsibility of the person who has determined its compatibility with the product. This person should also continuously review all specifications of the product referring to its latest catalog information, with a view to giving due consideration to any possibility of equipment failure when configuring the equipment.
- 2. Only personnel with appropriate training should operate machinery and equipment.**
The product specified here may become unsafe if handled incorrectly. The assembly, operation and maintenance of machines or equipment including our products must be performed by an operator who is appropriately trained and experienced.
- 3. Do not service or attempt to remove product and machinery/equipment until safety is confirmed.**
 1. The inspection and maintenance of machinery/equipment should only be performed after measures to prevent falling or runaway of the driven objects have been confirmed.
 2. When the product is to be removed, confirm that the safety measures as mentioned above are implemented and the power from any appropriate source is cut, and read and understand the specific product precautions of all relevant products carefully.
 3. Before machinery/equipment is restarted, take measures to prevent unexpected operation and malfunction.
- 4. Our products cannot be used beyond their specifications. Our products are not developed, designed, and manufactured to be used under the following conditions or environments. Use under such conditions or environments is not covered.**
 1. Conditions and environments outside of the given specifications, or use outdoors or in a place exposed to direct sunlight.
 2. Use for nuclear power, railways, aviation, space equipment, ships, vehicles, military application, equipment affecting human life, body, and property, fuel equipment, entertainment equipment, emergency shut-off circuits, press clutches, brake circuits, safety equipment, etc., and use for applications that do not conform to standard specifications such as catalogs and operation manuals.
 3. Use for interlock circuits, except for use with double interlock such as installing a mechanical protection function in case of failure. Please periodically inspect the product to confirm that the product is operating properly.



Safety Instructions

Caution

We develop, design, and manufacture our products to be used for automatic control equipment, and provide them for peaceful use in manufacturing industries.

Use in non-manufacturing industries is not covered.

Products we manufacture and sell cannot be used for the purpose of transactions or certification specified in the Measurement Act.

The new Measurement Act prohibits use of any unit other than SI units in Japan.

Limited warranty and Disclaimer/Compliance Requirements

The product used is subject to the following “Limited warranty and Disclaimer” and “Compliance Requirements”.

Read and accept them before using the product.

Limited warranty and Disclaimer

1. The warranty period of the product is 1 year in service or 1.5 years after the product is delivered, whichever is first.*2)
Also, the product may have specified durability, running distance or replacement parts. Please consult your nearest sales branch.
2. For any failure or damage reported within the warranty period which is clearly our responsibility, a replacement product or necessary parts will be provided.
This limited warranty applies only to our product independently, and not to any other damage incurred due to the failure of the product.
3. Prior to using SMC products, please read and understand the warranty terms and disclaimers noted in the specified catalog for the particular products.

***2) Vacuum pads are excluded from this 1 year warranty.**

A vacuum pad is a consumable part, so it is warranted for a year after it is delivered.

Also, even within the warranty period, the wear of a product due to the use of the vacuum pad or failure due to the deterioration of rubber material are not covered by the limited warranty

Compliance Requirements

1. The use of SMC products with production equipment for the manufacture of weapons of mass destruction (WMD) or any other weapon is strictly prohibited.
2. The exports of SMC products or technology from one country to another are governed by the relevant security laws and regulations of the countries involved in the transaction. Prior to the shipment of a SMC product to another country, assure that all local rules governing that export are known and followed.

Operator

- ◆ This operation manual is intended for those who have knowledge of machinery using pneumatic equipment, and have sufficient knowledge of assembly, operation and maintenance of such equipment. Only those persons are allowed to perform assembly, operation and maintenance.
- ◆ Read and understand this operation manual carefully before assembling, operating or providing maintenance to the product.

■ Safety Instructions

Warning

- Do not disassemble, modify (including changing the printed circuit board) or repair.
An injury or failure can result.
- Do not operate the product outside of the specifications.
Do not use for flammable or harmful fluids.
Fire, malfunction, or damage to the product can result.
Verify the specifications before use.
- Do not operate in an atmosphere containing flammable or explosive gases.
Fire or an explosion can result.
This product is not designed to be explosion proof.
- If using the product in an interlocking circuit:
 - Provide a double interlocking system, for example a mechanical system.
 - Check the product regularly for proper operation.Otherwise malfunction can result, causing an accident.
- The following instructions must be followed during maintenance:
 - Turn off the power supply.
 - Stop the air supply, exhaust the residual pressure and verify that the air is released before performing maintenance.Otherwise an injury can result.

Caution

- After maintenance is complete, perform appropriate functional inspections.
Stop operation if the equipment does not function properly.
Safety cannot be assured in the case of unexpected malfunction.
- Provide grounding to assure the noise resistance of the Serial System.
Individual grounding should be provided close to the product with a short cable.

■NOTE

Follow the instructions given below when designing, selecting and handling the product.

- The instructions on design and selection (installation, wiring, environment, adjustment, operation, maintenance, etc.) described below must also be followed.

Product specifications

- When conformity to UL is required, the SI unit should be used with a UL1310 Class 2 power supply.
- The SI unit is a UL approved product only if they have a  mark on the body.
- Use the specified voltage.

Otherwise failure or malfunction can result.

- Reserve a space for maintenance.

Allow sufficient space for maintenance when designing the system.

- Do not remove any nameplates or labels.

This can lead to incorrect maintenance, or misreading of the operation manual, which could cause damage or malfunction to the product.

It may also result in non-conformity to safety standards.

•Product handling

*Installation

- Do not drop, hit or apply excessive shock to the fieldbus system.
Otherwise damage to the product can result, causing malfunction.
- Tighten to the specified tightening torque.
If the tightening torque is exceeded the mounting screws may be broken.
IP67 protection cannot be guaranteed if the screws are not tightened to the specified torque.
- Never mount a product in a location that will be used as a foothold.
The product may be damaged if excessive force is applied by stepping or climbing onto it.

*Wiring

- Avoid repeatedly bending or stretching the cables, or placing heavy load on them.
Repetitive bending stress or tensile stress can cause breakage of the cable.
- Wire correctly.
Incorrect wiring can break the product.
- Do not perform wiring while the power is on.
Otherwise damage to the fieldbus system and/or I/O device can result, causing malfunction.
- Do not route wires and cables together with power or high voltage cables.
Otherwise the fieldbus system and/or I/O device can malfunction due to interference of noise and surge voltage from power and high voltage cables to the signal line.
Route the wires (piping) of the fieldbus system and/or I/O device separately from power or high voltage cables.
- Confirm proper insulation of wiring.
Poor insulation (interference from another circuit, poor insulation between terminals, etc.) can lead to excess voltage or current being applied to the product, causing damage.
- Take appropriate measures against noise, such as using a noise filter, when the fieldbus system is incorporated into equipment.
Otherwise noise can cause malfunction.
- Separate the power line for output devices from the power line for control.
Otherwise noise or induced surge voltage can cause malfunction.

*Environment

- Select the proper type of protection according to the environment of operation.
IP67 protection is achieved when the following conditions are met.
(1) The units are connected properly with fieldbus cable with M12 connector and power cable with M12 (M8) connector.
(2) Suitable mounting of each unit and manifold valve.
If using in an environment that is exposed to water splashes, please take measures such as using a cover.
- Do not use in a place where the product could be splashed by oil or chemicals.
If the product is to be used in an environment containing oils or chemicals such as coolant or cleaning solvent, even for a short time, it may be adversely affected (damage, malfunction etc.).
- Do not use the product in an environment where corrosive gases or fluids could be splashed.
Otherwise damage to the product and malfunction can result.
- Do not use in an area where surges are generated.
If there is equipment which generates a large amount of surge (solenoid type lifter, high frequency induction furnace, motor, etc.) close to the fieldbus system, this may cause deterioration or breakage of the internal circuit of the fieldbus system. Avoid sources of surge generation and crossed lines.
- When a surge-generating load such as a relay or solenoid is driven directly, use an fieldbus system with a built-in surge absorbing element.
Direct drive of a load generating surge voltage can damage the fieldbus system.
- The product is CE/UKCA marked, but not immune to lightning strikes. Take measures against lightning strikes in the system.
- Prevent foreign matter such as remnant of wires from entering the fieldbus system to avoid failure and malfunction.

- Mount the product in a place that is not exposed to excessive vibration or impact.
Otherwise failure or malfunction can result.
- Do not use the product in an environment that is exposed to temperature cycle.
Heat cycles other than ordinary changes in temperature can adversely affect the inside of the product.
- Do not expose the product to direct sunlight.
If using in a location directly exposed to sunlight, shade the product from the sunlight.
Otherwise failure or malfunction can result.
- Keep within the specified ambient temperature range.
Otherwise malfunction can result.
- Do not operate close to a heat source, or in a location exposed to radiant heat.
Otherwise malfunction can result.

*Adjustment and Operation

- Perform settings suitable for the operating conditions.
Incorrect setting can cause operation failure.
- Please refer to the PLC manufacturer's manual etc. for details of programming and addresses.
For the PLC protocol and programming refer to the relevant manufacturer's documentation.
- The surface on the product may be hot.

*Maintenance

- Turn off the power supply, stop the supplied air, exhaust the residual pressure and verify the release of air before performing maintenance.
There is a risk of unexpected malfunction.
- Perform regular maintenance and inspections.
There is a risk of unexpected malfunction.
- After maintenance is complete, perform appropriate functional inspections.
Stop operation if the equipment does not function properly.
Otherwise safety is not assured due to an unexpected malfunction or incorrect operation.
- Do not use solvents such as benzene, thinner etc. to clean the each unit.
They could damage the surface of the body and erase the markings on the body.
Use a soft cloth to remove stains.
For heavy stains, use a cloth soaked with diluted neutral detergent and fully squeezed, then wipe up the stains again with a dry cloth.

Model Indication and How to Order

EX260-SIL 1

• Connector type, output specification

1

M12 connector, 32 outputs, PNP (negative common) / source

• Fieldbus

IL

IO-Link *

*: IO-Link is the first standardized IO technology worldwide (IEC 61131-9) for the communication with sensors and also actuators and it is being disseminated under a dedicated word mark/logo,  **IO-Link**

Summary of Product elements

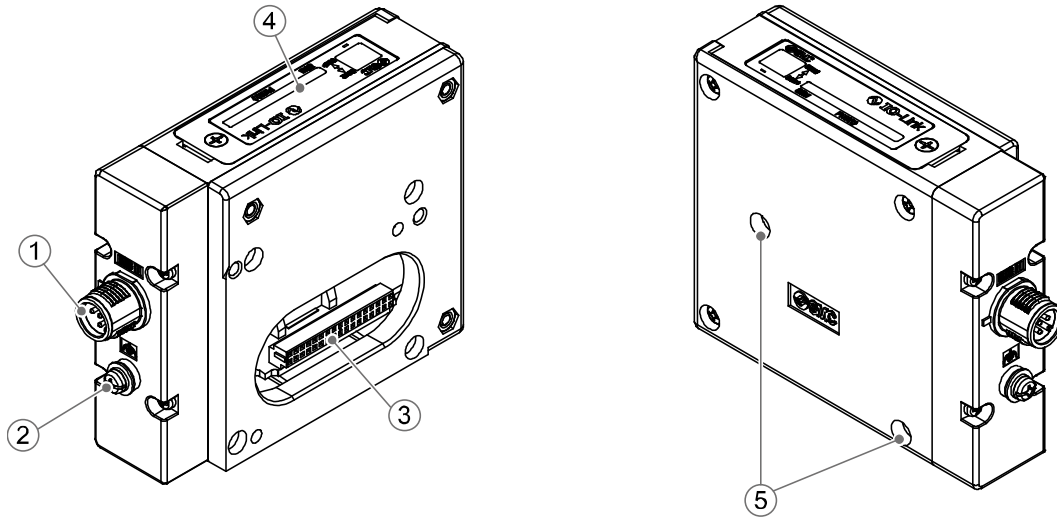

No.	Element	Description
1	IO-Link communication/ power supply connector	IO-Link communication interface for connection (Port Class B) including power supply for solenoid valves (M12 5-pin plug, A-coded)
2	FE terminal	Functional earth (M3 screw)
3	Output connector	Output signal interface for solenoid valve manifold
4	LED and switch	LED display to indicate the state of the SI unit * Switch for setting of data transmission rate (COM2 or COM3)
5	Mounting hole	Mounting hole for connection to the solenoid valve manifold

*: Refer to page 13 for the LED Indication, Settings and State Monitoring.

Accessories

Hexagon socket head cap screw	2 pcs. M3 x 30 screw for connection to the solenoid valve manifold
-------------------------------	--

■ Summary of product function

● I/O function

This device can control 32 outputs for solenoid valve control and check device stats using cyclic data communication via IO-Link system.

● Fault action

Output action at a communication fault can be set by parameter, either Clear Output, Force Output or Hold Last State.

● Output switching counter

This device can count the number of output switching cycles on each single output and the count value can be automatically stored in the device every hour or automatically* in the SI unit when the IO-Link power is turned off.

*: Depending on the situation of the voltage change at power OFF, it may not be possible to save.

● Device condition (diagnosis) monitoring

This device can provide information about the device condition (diagnosis) over the IO-Link.

- This device can detect various error state, such as internal hardware fault and output open/short circuit.
- This device can detect various warning state, such as solenoid power over-run/under-run and device temperature over-run.
- Also, the device can notify when the output switching count reaches the upper limit value set by the user arbitrarily.

● Data Storage function

Data Storage is a function which enables a consistent and up-to-date set of device parameters to be stored in the Master. The main purpose of the IO-Link Data Storage mechanism is to ease the replacement of defect devices without using configuration, parameterization, or other tools.

When the user has assigned parameter values with the help of engineering tools, they are downloaded into the device and become active parameters. Upon a system command, these parameters are uploaded (copied) into the Data Storage within the Master.

The stored (saved) set of back-up parameters overwrite the active parameters (e.g. factory settings) within the compatible replacement device.

Data Storage provides three different "Backup Levels" of parameters to be defined on the Master port using engineering tools, Commissioning ("Disable"), Production ("Backup/Restore") and Production ("Restore"). "Backup" means that upload is enabled and "Restore" means that download is enabled.

Installation and Wiring

■ Installation

Connect solenoid valve manifold to the SI unit.

● Dimensions for installation

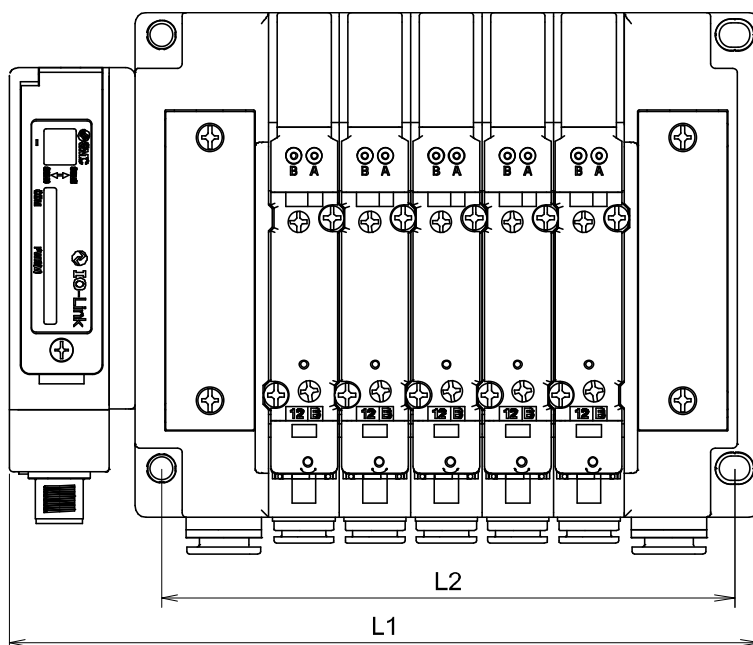

n: number of solenoid valve stations

L \ n	1	2	3	4	5	6	7	8
L1		120.7	136.7	152.7	168.7	184.7	200.7	216.7
L2		80	96	112	128	144	160	176
L \ n	9	10	11	12	13	14	15	16
L1	232.7	248.7	264.7	280.7	296.7	312.7	328.7	344.7
L2	192	208	224	240	256	272	288	304

(mm)

The above table shows dimensions as an example for the SY5000 series solenoid valve manifold.

■Wiring

Select the appropriate cables to mate with the connectors mounted on the SI unit.

- IO-Link communication and power supply connector layout (Port Class B)

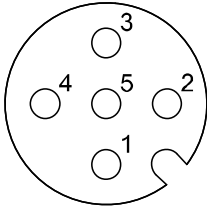

BUS IN: M12 5-pin plug, A-coded

No.	Designation	Description
1	L+	+24 V for SI unit
2	SV24 V	+24 V for solenoid valve
3	L-	0 V for SI unit
4	C/Q	IO-Link communication line
5	SV0 V	0 V for solenoid valve

- FE terminal

Connect the FE terminal to ground.

Resistance to ground should be 100 ohms or less.

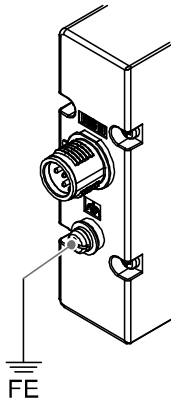

LED Indication, Settings and State Monitoring

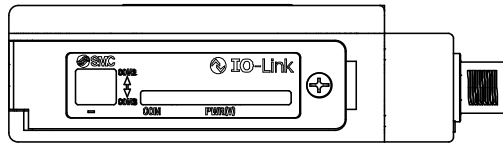

■LED indication



LED	LED State	Description
COM	<input checked="" type="checkbox"/> Green ON	Power ON, IO-Link communication inactive
	<input type="checkbox"/> Green OFF	Power OFF
	<input checked="" type="checkbox"/> Flashing Green	IO-Link communication active
PWR(V)	<input checked="" type="checkbox"/> Green ON	Power for the solenoid valve is supplied
	<input type="checkbox"/> OFF	Power for the solenoid valve is not supplied or outside the tolerance range (19 V or less)

■Switch setting (Process data size / Data transmission rate setting)

The switch should only be set with the power supply turned off.

Open the cover and set the DIP switch with a small flat blade screwdriver.

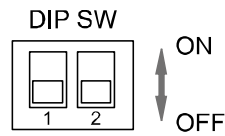

Data transmission rate

COM2/COM3	No.2	Description
COM2	ON	COM2 (38.4 kbps)
COM3	OFF	COM3 (230.4 kbps)

*: Default setting is COM3 (OFF).

Process data size

No.1	Process data size
ON	2 bytes input/4 bytes output (2 bytes input: Device Status)
OFF	0 byte input/4 bytes output

*: Default setting is 0 byte input/4 bytes output (OFF).

*: The appropriate IODD file depends on each setting such as data transmission rate and process data size.

Refer to the following IODD file list for details (page 14).

■Parameter settings and state monitoring

●IODD file

An IODD (I/O Device Description) is a file that provides all the necessary properties to establish communication and the necessary parameters and their boundaries to establish the desired function of a sensor or actuator.

It is the set of files of the main IODD file and image files such as a vendor logo, device picture and device icon.

The corresponding IODD files of each product are as follows.

	Product Number	Data Transmission rate	Process data size	IODD File *
1	EX260-SIL1	COM3 (230.4 kbps)	0 byte input/4 bytes output	SMC-EX260-SIL1_04_3-yyyyymmdd-IODD1.1
2		COM2 (38.4 kbps)		SMC-EX260-SIL1_04_2-yyyyymmdd-IODD1.1
3		COM3 (230.4 kbps)	2 bytes input/4 bytes output (2 bytes input: Device State)	SMC-EX260-SIL1_24_3-yyyyymmdd-IODD1.1
4		COM2 (38.4 kbps)		SMC-EX260-SIL1_24_2-yyyyymmdd-IODD1.1

*: "yyyyymmdd" in the file name indicates data of file creation, where yyyy is the year, mm is the month and dd is the day.

●Data Storage

Data Storage is function which enables a consistent and up-to-date set of device parameters to be stored in the Master.

When a single parameter (Index and Subindex) is changed and the changed parameters need to be uploaded (copied) to the Master, a SystemCommand "ParamDownloadStore" needs to be sent to the SI unit by the user to back up the parameters.

When entire parameters are set in the SI unit using "block parameter" from the IO-Link Tool, a SystemCommand "ParamDownloadStore" will be sent automatically as a part of the block parameter transmission sequence (the user does not need to execute that SystemCommand).

The stored (saved) set of back-up parameters can overwrite the active parameters (e.g. factory settings) within a compatible replacement SI unit.

●Service data

The following table defines the parameters with read or write access, the so-called Direct Parameter Page with a simplified access method and the ISDU parameter for complex parameters and commands.

Direct Parameter Page 1

DPP1 Address	Access	Parameter Name	Value
0x07	R	Vendor ID	131
0x08			
0x09	R	Device ID	344: EX260-SIL1 (for in/out 0/4 bytes COM3)
0x0A			345: EX260-SIL1 (for in/out 0/4 bytes COM2)
0x0B			346: EX260-SIL1 (for in/out 2/4 bytes COM3) 347: EX260-SIL1 (for in/out 2/4 bytes COM2)

ISDU Parameters

ISDU		Access *1	Parameter Name	Data Storage *2	Value
Index (dec)	Sub-Index				
0x0002 (2)	0	W	SystemCommand	N	Refer to page 16 "Coding of System Command" for details
0x000C (12)	0	R/W	Device Access Locks	N	Refer to page 17 "Device Access Locks" for details
0x0010 (16)	0	R	Vendor Name	N	SMC Corporation
0x0011 (17)	0	R	Vendor Text	N	www.smcworld.com
0x0012 (18)	0	R	Product Name	N	EX260-SIL1_in/out_0/4 byte_COM3 (It depends on switch setting *3)
0x0013 (19)	0	R	Product ID	N	EX260-SIL1
0x0014 (20)	0	R	Product Text	N	SI unit
0x0015 (21)	0	R	Serial Number	N	"xxxxxxxx" *4
0x0016 (22)	0	R	Hardware Revision	N	HW-Vx.y *5
0x0017 (23)	0	R	Software Revision	N	FW-Vx.y *5
0x0018 (24)	0	R/W	Application Specific Tag	Y	"*****" *****" *6
0x0024 (36)	0	R	Device State	N	Refer to page 17 "Device State parameter" for details
0x0025 (37)	1..8	R	Detailed Device State	N	Refer to page 17 "Detailed Device State parameter" for details

*1: Where "R" is Read and "W" is Write.

*2: Where "Y" means "included in DataStorage" and "N" means "Not included in Data Storage"

*3: EX260-SIL1_in/out_0/4 byte_COM3
EX260-SIL1_in/out_0/4 byte_COM2
EX260-SIL1_in/out_2/4 byte_COM3
EX260-SIL1_in/out_2/4 byte_COM2

*4: The data type is a character string with a fixed length of 8 octets.

*5: Where "x" is the major revision number, "y" is the minor revision number.

*6: The data type is a character string with a length from 16 to 32 octets.

Coding of SystemCommand (index 2)

For ParamDownloadStore, Device reset, Application reset, Restore factory settings or Output switching count value reset, the ISDU Index 0x002 (SystemCommand) should be used.

The buttons, a command interface to the SI unit, labelled with the following command name (except ParamDownloadStore) are displayed in the IO-Link Tool. Each command is sent to the SI unit when the button is clicked.

The coding of SystemCommand is specified in the following table.

Command (dec)	Command name	Definition
0x05 (5)	ParamDownloadStore	Backup instruction of parameter data SI unit initiates a new Data Storage upload to the Master
0x80 (128)	Device reset	SI unit to perform a "warm start". SI unit is reset to an initial state such as power-on
0x81 (129)	Application reset	All outputs switching count value are cleared
0x82 (130)	Restore factory settings	All parameter values are restored to factory default setting and all output count values are cleared
0xA0 (160)	OUT0 count value reset	Output 0 count value is cleared
0xA1 (161)	OUT1 count value reset	Output 1 count value is cleared
0xA2 (162)	OUT2 count value reset	Output 2 count value is cleared
⋮	⋮	⋮
0xAA (170)	OUT10 count value reset	Output 10 count value is cleared
⋮	⋮	⋮
0xAF (175)	OUT15 count value reset	Output 15 count value is cleared
⋮	⋮	⋮
0xBE (190)	OUT30 count value reset	Output 30 count value is cleared
0xBF (191)	OUT31 count value reset	Output 31 count value is cleared

Device Access Locks (index 12)

For Device Access Locks, the following Device locking possibilities are specified.

Value	Definition
0	unlocked
1	parameter (write) access locked
2	data storage locked
3	parameter (write) access locked and data storage locked

Parameter (write) access:

If the "Parameter (write) access" bit is set in the SI unit, write access to all SI unit parameters over the IO-Link communication is inhibited for all read/write parameters of the SI unit except the parameter Device Access Locks. The SI unit responds with the negative service response - access denied - to a write access, if the parameter access is locked.

Read access is not affected.

Note that the parameter (write) access lock does not block downloads of the Data Storage mechanism.

Data Storage:

If the "Data storage" bit is set in the SI unit, the Data Storage mechanism of the SI unit is disabled. In this case, the SI unit responds with a negative service response – access denied - to a write access.

Read access to its Data Storage Index is not affected.

Device State parameter (index 36)

For Device state, the following Device conditions are specified.

Value	State definition	Details
0	In normal operation	-
1	Maintenance-Required	Output Switching counter value over-run
2	Out-of-Specification	Solenoid power voltage over-run Solenoid power voltage under-run
3	Functional-Check	N/A
4	Failure	- SI unit hardware fault - SI unit other internal fault - Output short circuit - Output open circuit

Detailed Device State parameter (index 37)

For Detailed Device state, the following events are specified.

Sub-index	Event definition	Event category		Event code
		Definition	Value	
1	SI unit hardware fault	Error	0xF4	0x5000
2	Non volatile memory loss	Error	0xF4	0x5011
3	Output short circuit	Error	0xF4	0x7710
4	Output open circuit	Error	0xF4	0x1810
5	Solenoid power supply voltage over-run	Warning	0xE4	0x1820
6	Solenoid power supply voltage under-run	Warning	0xE4	0x1821
7	SI unit internal temperature over-run	Warning	0xE4	0x4210
8	Output switching count value over-run	Notification	0xD4	0x1830

Application Specific Parameters

Index (dec)	Sub-index	Access *1	Parameter name	Data type	Default	Data Storage *2	Description
0x54 (84)	1,2,3,4	R/W	Output Fault Action	U8	{0,0,0,0}	Y	Determine how the SI unit output act when a IO-Link communication fault (individual setting from OUT0 to OUT31) 0: Output Fault Value parameter setting value 1: hold last state
0x55 (85)	1,2,3,4	R/W	Output Fault Value	U8	{0,0,0,0}	Y	If the Output Fault Action parameter is set to 0, the output of the SI unit responds with a user-defined fault value when a communication fault. (individual setting from OUT0 to OUT31) 0: Clear Output (Set 0) 1: Force Output (Set 1)
0x44 (68)	1..32	R	Output Switching Counts	U32	{0,0...}	N	Count the number of switching times of each output. The count value is saved*3 every hour, or automatically*4 in the SI unit when the IO-Link power is turned off. When the counter reaches the maximum value 4,294,967,295, this value is retained and it does not return to zero.
0x56 (86)	1,2,3,4	R/W	Output Open Circuit Detection	U8	{0,0,0,0}	Y	Enable / disable Output Open Circuit Detection (individual setting from OUT0 to OUT31) 0: disable 1: enable
0x57 (87)	1,2,3,4	R	Output Open Circuit State	U8	{0,0,0,0}	N	Output state for open circuit (individual state from OUT0 to OUT31) 0: normal 1: open circuit

Application Specific Parameters (continue)

Index (dec)	Sub-index	Access *1	Parameter name	Data type	Default	Data Storage *2	Description
0x58 (88)	1, 2, 3, 4	R	Output Short Circuit State	U8	{0, 0, 0, 0}	N	Output state for short circuit (individual state from OUT0 to OUT31) 0: normal 1: short circuit
0x4C (76)	1..32	R/W	Output Switching Counts Set Point	U32	{4294967295, .., 4294967295}	Y	Set count threshold of output switching count (Setting range: 0 to 4294967295) When the count value reaches the set value, a notification event "Output switching count value over-run" is generated.
0x4D (77)	1, 2, 3, 4	R	Output Switching Counts State	U8	{0, 0, 0, 0}	N	Output state for switching counts threshold exceeded (individual state from OUT0 to OUT31) 0: normal 1: exceed

*1: "R" is Read and "W" is Write.

*2: "Y" means "included in Data Storage" and "N" means "Not included in Data Storage"

*3: Output switching is counted under the following condition.

- Output is switched from low to high, or
- Solenoid valve power is switched from OFF to ON while output is ON

When the SI unit is in an error state such as Device hardware fault, Output open/short circuit or solenoid power over-run/under-run, output switching will not be counted.

*4: Depending on the situation of the voltage change at power OFF, it may not be possible to save.

*5: Refer to the table below for the symbol.

Symbol	Data type (IO-Link Standard)	Data length Bit[byte]	Description
U8	UIntegerT	8[1]	unsigned integer
U32		32[4]	

Structure of Output Fault Action / Output Fault Value Parameter (index 84, 85)

Set the output (output 0 to output 31) at a IO-Link communication fault with two indexes.

For each output assignment, bit 0 corresponds to output 0 and bit 1 corresponds to output 1 by sub index.

Set the values below 2 bits for all outputs.

Index 84 Output Fault Action	Index 85 Output Fault Value	Output setting state at a communication fault
0	0	Clear Output (set 0)
0	1	Force Output (set 1)
1	x	Hold Last State

An example of setting is shown below.

Sub-Index	Output	Output setting	Bit No.	Index 84 Output Fault Action								Index 85 Output Fault Value									
				Value	7	6	5	4	3	2	1	0	Value	7	6	5	4	3	2	1	0
1	0-7	All clear output	Output No.	-	7	6	5	4	3	2	1	0	-	7	6	5	4	3	2	1	0
			Setting value	00	0	0	0	0	0	0	0	0	0	0	00	0	0	0	0	0	0
2	8-15	All hold last state	Output No.	-	15	14	13	12	11	10	9	8	-	15	14	13	12	11	10	9	8
			Setting value	FF	1	1	1	1	1	1	1	1	1	00	0	0	0	0	0	0	0
3	16-23	All force output	Output No.	-	23	22	21	20	19	18	17	16	-	23	22	21	20	19	18	17	16
			Setting value	00	0	0	0	0	0	0	0	0	0	FF	1	1	1	1	1	1	1
4	24-31	Output 24-27: Force output	Output No.	-	31	30	29	28	27	26	25	24	-	31	30	29	28	27	26	25	24
		Output 28-31: Hold last state	Setting value	F0	1	1	1	1	0	0	0	0	0F	0	0	0	0	1	1	1	1

Structure of Output Switching Counts (index 68)

The output switching count parameter consists of thirty-two sub-indices that represent bit fields with a size of 32 bits each. Sub-index 1 corresponds to output line 0 cycle count, Sub-index 2 to output line 1 cycle count and so on.

The following shows an example of switching cycle count value 10.000.000 cycles according to the transmission method of the upper communication.

10.000.000(dec) = 80 96 98 00 (hex) (little endian)

10.000.000(dec) = 00 98 96 80 (hex) (big endian)

*: For details of conditions that output switching count, refer to note out of the table in page 19.

Structure of Output Open Circuit Detection Parameter (index 86)

Determine enable/disable of the open circuit detecting function of each output (output 0 to output 31) by four 8-bit long sub-index.

Bit 0 in the bit field corresponds to Output 0, Bit 1 to Output 1 and so on.

An example of setting is shown below.

Sub-Index	Output	Output Open Circuit Detection	Bit No.	Output Open Circuit Detection								
				Value	7	6	5	4	3	2	1	0
1	0-7	All disable	Output No.	-	7	6	5	4	3	2	1	0
			Setting value	00	0	0	0	0	0	0	0	0
2	8-15	All enable	Output No.	-	15	14	13	12	11	10	9	8
			Setting value	FF	1	1	1	1	1	1	1	1
3	16-23	All disable	Output No.	-	23	22	21	20	19	18	17	16
			Setting value	00	0	0	0	0	0	0	0	0
4	24-31	Output 24-27: disable Output 28-31: enable	Output No.	-	31	30	29	28	27	26	25	24
			Setting value	F0	1	1	1	1	0	0	0	0

Structure of Output Open Circuit State Parameter (index 87)

The output state for open circuit of each output (output 0 to output 31) is indicated by four 8-bit long sub index.

An example of state is shown below.

Sub-Index	Output	Output Open Circuit State	Bit No.	Output Open Circuit State								
				Value	7	6	5	4	3	2	1	0
1	0-7	All output normal	Output No.	-	7	6	5	4	3	2	1	0
			State value	00	0	0	0	0	0	0	0	0
2	8-15	All output open circuit	Output No.	-	15	14	13	12	11	10	9	8
			State value	FF	1	1	1	1	1	1	1	1
3	16-23	All output normal	Output No.	-	23	22	21	20	19	18	17	16
			State value	00	0	0	0	0	0	0	0	0
4	24-31	Output 24-27: normal Output 28-31: open circuit	Output No.	-	31	30	29	28	27	26	25	24
			State value	F0	1	1	1	1	0	0	0	0

Structure of Output Short Circuit State Parameter (index 88)

The output state for short circuit of each output (output 0 to output 31) is indicated by four 8-bit long sub index.

An example of state is shown below.

Sub-Index	Output	Output Short Circuit State	Bit No.	Output Short Circuit State								
				Value	7	6	5	4	3	2	1	0
1	0-7	All output normal	Output No.	-	7	6	5	4	3	2	1	0
			State value	00	0	0	0	0	0	0	0	0
2	8-15	All output short circuit	Output No.	-	15	14	13	12	11	10	9	8
			State value	FF	1	1	1	1	1	1	1	1
3	16-23	All output normal	Output No.	-	23	22	21	20	19	18	17	16
			State value	00	0	0	0	0	0	0	0	0
4	24-31	Output 24-27: normal Output 28-31: short circuit	Output No.	-	31	30	29	28	27	26	25	24
			State value	F0	1	1	1	1	0	0	0	0

Structure of Output Switching Counts Set Point (index 76)

Set count threshold of output switching count of each output (output 0 to output 31) with 32 bit length respectively.

Sub index 1 corresponds to output 0, sub index 2 corresponds to output 1 and so on.

For each output, the threshold can be set up to 4,294,967,295 (0xFFFFFFFF).

When the count value reaches the set value, a notification event "Output switching count value over-run" is generated.

An example of setting is shown below.

The following shows an example of a switching count set point with 50.000.000 cycles according to the transmission method of the upper communication.

50.000.000(dec) = 80 F0 FA 02 (hex) (little endian)

50.000.000(dec) = 02 FA F0 80 (hex) (big endian)

Structure of Output Switching Counts State (index 77)

The output state for switching counts threshold exceeded of each output (output 0 to output 31) is indicated by four 8-bit long sub index.

An example of setting is shown below.

Sub-Index	Output	Output switching counts threshold exceeded state	Bit No.	Output Open Circuit State								
				Value	7	6	5	4	3	2	1	0
1	0-7	All output normal	Output No.	-	7	6	5	4	3	2	1	0
			State value	00	0	0	0	0	0	0	0	0
2	8-15	All output exceeded	Output No.	-	15	14	13	12	11	10	9	8
			State value	FF	1	1	1	1	1	1	1	1
3	16-23	All output normal	Output No.	-	23	22	21	20	19	18	17	16
			State value	00	0	0	0	0	0	0	0	0
4	24-31	Output 24-27: normal Output 28-31: exceeded	Output No.	-	31	30	29	28	27	26	25	24
			State value	F0	1	1	1	1	0	0	0	0

■ Output number layout / Process data

The process data of this product is designed with byte array base data type, so the byte order when solenoid output is allocated on the PLC memory is based on the endian type of the transmission format of the IO-Link master gateway upper communication, either big endian format or little endian format.

The following illustration shows the byte order in each case.

For the fieldbus / Industrial Ethernet with the big endian transmission format

(e.g. Profibus-DP, ProfiNet)

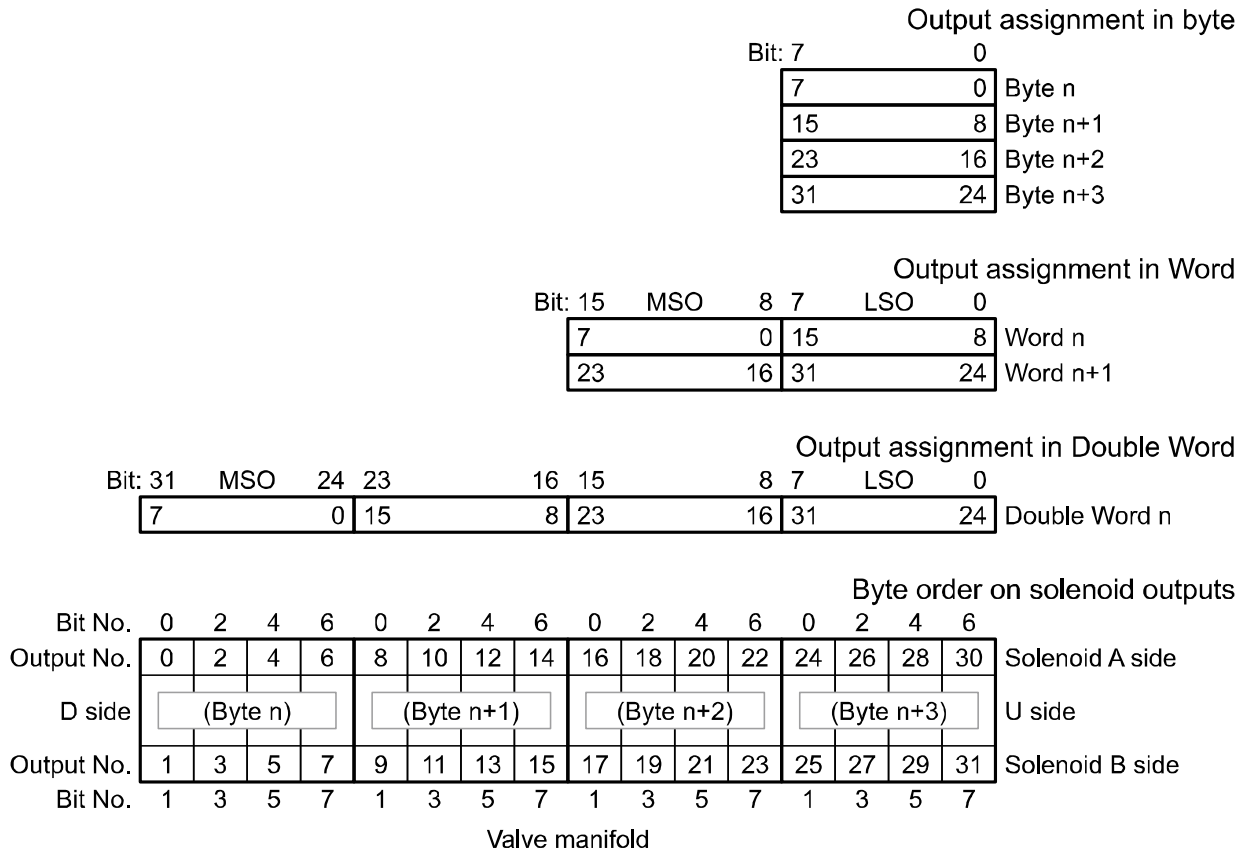

For the fieldbus / Industrial Ethernet with the little endian transmission format
(e.g. EtherNet/IP, EtherCAT, CC-Link IE)

Output assignment in byte

Bit: 7	0	
7	0	Byte n
15	8	Byte n+1
23	16	Byte n+2
31	24	Byte n+3

Output assignment in Word

Bit: 15	MSO	8	7	LSO	0	
15		8	7		0	Word n
31		24	23		16	Word n+1

Output assignment in Double Word

Bit: 31	MSO	24	23	16	15	8	7	LSO	0	
31		24	23	16	15	8	7		0	Double Word n

Byte order on solenoid outputs

Bit No.	0	2	4	6	0	2	4	6	0	2	4	6	0	2	4	6	
Output No.	0	2	4	6	8	10	12	14	16	18	20	22	24	26	28	30	Solenoid A side
D side	(Byte n)				(Byte n+1)				(Byte n+2)				(Byte n+3)				U side
Output No.	1	3	5	7	9	11	13	15	17	19	21	23	25	27	29	31	Solenoid B side
Bit No.	1	3	5	7	1	3	5	7	1	3	5	7	1	3	5	7	

Valve manifold

The output numbering refers to the solenoid position on the manifold and starts at zero.

Standard wiring of the manifold is for a double-solenoid valve. The output number starts at the A side and then B side in that order as shown in figure a.

If a single-solenoid valve is mounted on the standard wiring manifold, the output number for the B side solenoid valve is skipped.

Custom wiring for the mixed mounting single-solenoid valves and the double-solenoid-valves can be specified with a Wiring Specification Sheet. Example wiring is shown in figure b.

Bit state "0" and "1" in the data corresponds to solenoid valve state OFF and ON (0: OFF, 1: ON), and the output number starts at zero from LSB (least significant bit).

fig.a

	No.	Station	No.	
Double	4	3	5	
Single	2	2	3	free
Double	0	1	1	

fig.b

	No.	Station	No.
Double	3	3	4
Single	2	2	-
Double	0	1	1

■ Input number layout / Process data

In this product, Device State can be added to input data by the switch setting (Page 13).

(Refer to the table below)

Bit offset			Index 36 (Device State)		
2	1	0	value	State definition	Details
0	0	0	0	In normal operation	-
0	0	1	1	Maintenance required	Output switching counter value over-run
0	1	0	2	Out of specification	Solenoid power voltage over-run Solenoid power voltage under-run
0	1	1	3	Function check	N/A
1	0	0	4	Failure	- SI unit hardware fault - SI unit other internal fault - Output short circuit - Output open circuit

Bit offset	15	14	13	12	11	10	9	8	7	6	5	4	3	2	1	0
Item	Reserved							Reserved				Device State				

•The process data of this product is byte array type.

The above mapping in word data format is for the case where the transmission order of the upper communication is little endian.

Please note that the byte order will change in case of big endian.

Refer to the table below for the Endian type of the major upper communication.

Endian type	Upper communication protocol
Big-Endian type	Such as PROFIBUS and PROFINET
Little-Endian type	Such as EtherNET/IP, EtherCAT and CC-Link IE Field.

Troubleshooting and Maintenance

○ Troubleshooting chart

When any malfunction is observed, it is recommended to perform the following troubleshooting.

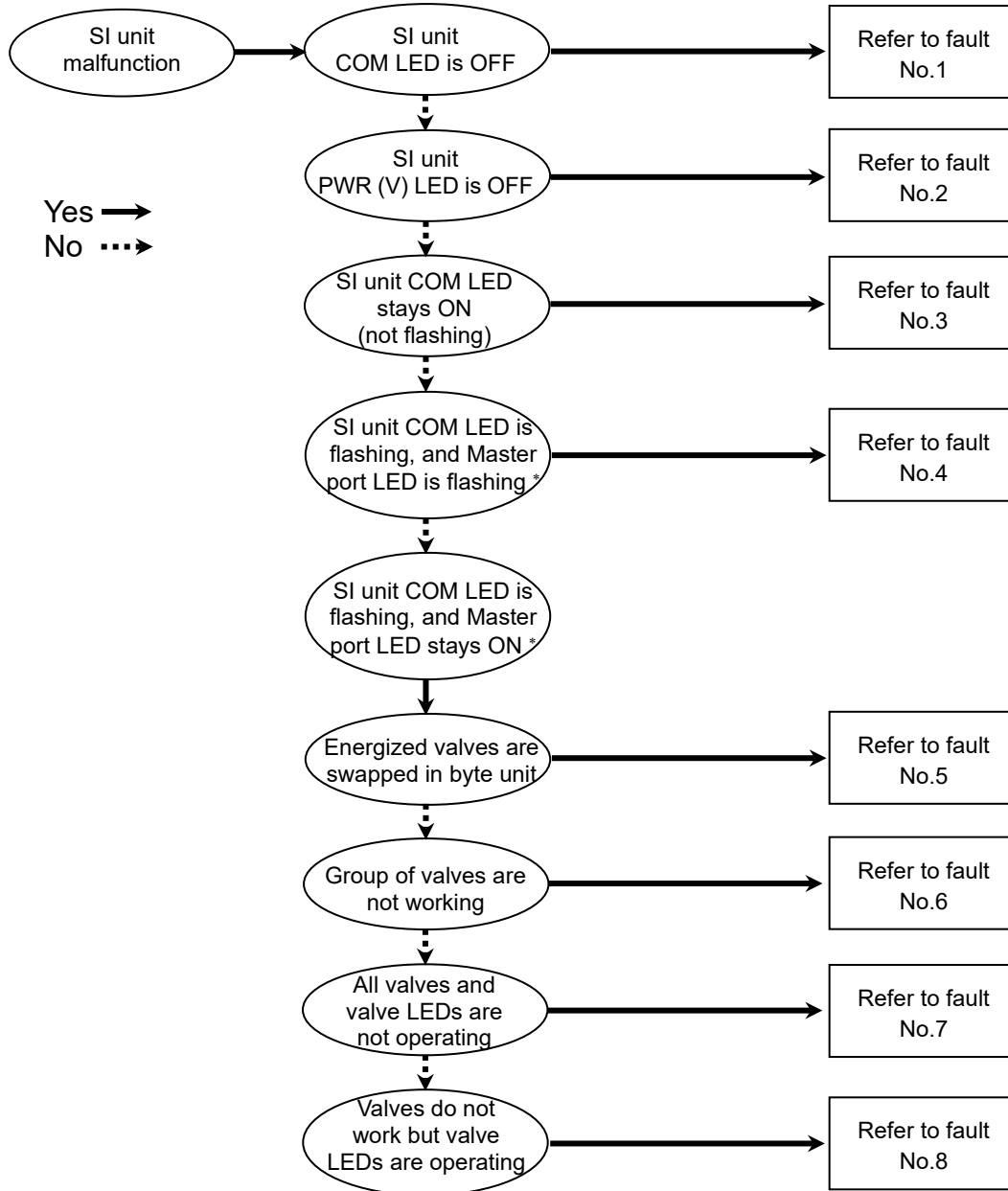

*: Depending on the master, the behavior of the port LED may be different. For details, please check the specifications of your master.

○ Troubleshooting table

Fault No.1

Fault	Probable cause	Recommended error handling	Recommended action
SI unit COM LED is OFF	Defective IO-Link cable wiring for SI unit operation	Check the condition of the IO-Link cable wiring to the SI unit.	Re-tighten the IO-Link cable. (Replace the cable if it is broken)
			Correct the IO-Link cable wiring layout.
	SI unit operating voltage is not supplied from the IO-Link Master	Check the condition of the supply voltage on the IO-Link Master.	Supply 20 VDC to 30 VDC to the IO-Link Master.

Fault No.2

Fault	Probable cause	Recommended error handling	Recommended action
SI unit PWR (V) LED is OFF	Defective power cable wiring for the solenoid valve	Check the condition of the power cable wiring for the valve.	Re-tighten the power cable. (Replace the cable if it is broken)
			Correct the power cable wiring layout.
	Load voltage for the valve is not supplied	Check the condition of the supply voltage for the valve.	Supply 24 VDC +10%/-5% to the valves.

Fault No.3

Fault	Probable cause	Recommended error handling	Recommended action
SI unit COM LED stays ON (not flashing)	IO-Link communication is inactive	If the Master port LED in which the SI unit is connected is flashing Green, * Check the IO-Link cable connection.	Make sure there is no broken wire between the Master and the SI unit. (Replace the cable if it is broken)
			Correct the IO-Link wiring layout. Tighten the IO-Link connector correctly.
		If the Master port LED in which the SI unit is connected is OFF, * Check the IO-Link port configuration on the Master.	Configure pin 4 to IO-Link for the IO-Link port of the IO-Link master. Configure process data length properly for the IO-Link port of the IO-Link master. (Process data length of IO-Link port of the master should be larger than that of the connected SI unit)

*: Depending on the master, the behavior of the port LED may be different. For details, please check the specifications of your master.

Fault No.4

Fault	Probable cause	Recommended error handling	Recommended action
SI unit COM LED is flashing, and Master port LED is flashing *	Master port has rejected the SI unit due to incompatible Device identification	If the inspection level of the Master port in which the SI unit is connected is TYPE_COMP, Check the Device ID of the SI unit.	Connect the SI unit with a Device ID that matches the ID configured in the Master port.
		If the inspection level of the Master port in which the SI unit is connected is IDENTICAL, Check the Serial Number of the SI unit.	Connect the SI unit with a Serial Number that matches the Serial Number configured in the Master port.
	IO-Link communication is active, but not in Operate mode	Check the parameter setting of the Data Storage Device Access Locks in the SI unit and the parameter setting of the Data Storage Backup Level in the Master.	Unlock the parameter for Data Storage Device Access Locks in the SI unit, or Disable the parameter for Data Storage Download of the Master port.

*: Depending on the master, the behavior of the port LED may be different. For details, please check the specifications of your master.

Fault No.5

Fault	Probable cause	Recommended error handling	Recommended action
Energized valves are swapped in the byte unit	Incorrect output assignment of the PLC programming	Check the PLC type of string Words in memory, either big endian type or little endian type.	Assign the output on the PLC programming based on an endian type of PLC memory. Refer to page 23 and 24 of this document for details.

Fault No.6

Fault	Probable cause	Recommended error handling	Recommended action
Group of valves not working	Too many valves	Check if solenoid count does not exceed the allowable number. This depends on the SI unit model and valve series. Allowable solenoid number by valve series: SY/JSY series: 32 points VQC series: 24 points	Keep the number of mounted solenoid valves within specification.

Fault No.7

Fault	Probable cause	Recommended error handling	Recommended action
All valves and valve LEDs are not operating	Poor connection between SI unit and valve manifold	Check if there are any loose screws making the connection between the SI unit and the valve manifold.	Tighten the screws with the specified tightening torque (i.e. 0.6 N•m) and make sure there is no gap between the SI unit and the valve manifold.
	Mismatch polarity between solenoid valve and SI unit output	Check if the solenoid valve common specification matches the output polarity of the SI unit.	Match polarity between solenoid valve and SI unit output.
	Defective solenoid valve	Follow the troubleshooting for the solenoid valve.	Same as left.

Fault No.8

Fault	Probable cause	Recommended error handling	Recommended action
Valves do not work but valve LEDs are operating	Mismatch polarity between solenoid valve and SI unit output	Check if the solenoid valve common specification matches the output polarity of the SI unit.	Match polarity between solenoid valve and SI unit output.

■ Maintenance

Replacement of the SI unit

- Remove the M3 hexagon screws from the SI unit and release the SI unit from the solenoid valve manifold.
- Replace the SI unit.
- Tighten the screws with the specified tightening torque. (0.6 N•m)

Precautions for maintenance

- (1) Be sure to switch off the power.
- (2) Check there is no foreign matter inside the SI unit.
- (3) Check there is no damage and no foreign matter on the gasket.
- (4) Be sure to tighten the screws with the specified torque.

If the SI unit is not assembled properly, inside PCBs may be damaged or liquid and/or dust may enter into the unit.

○ Assembly and disassembly of the SI unit

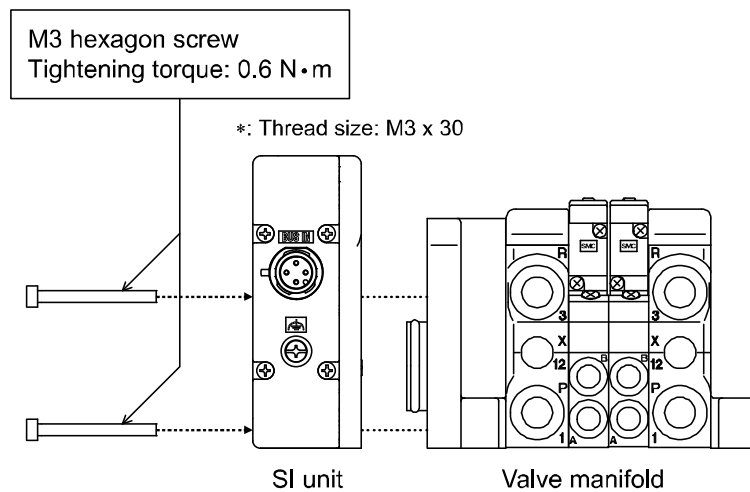

Specification

■ Specifications

General specifications

Item	Specifications
Ambient temperature	-10 to +50 °C
Ambient humidity	35 to 85%RH (No condensate)
Ambient temperature for storage	-20 to +60 °C
Withstand voltage	500 VAC applied for 1 minute
Insulation resistance	500 VDC, 10 MΩ or more
Operating atmosphere	No corrosive gas
Enclosure	IP67
Weight	200 g or less
Standards	UL/CSA, CE/UKCA marked

Electrical specifications

Item	Specifications
Current consumption in power supply voltage range	SI unit power supply 18 to 30 VDC 0.1 A max.
	Solenoid valve power supply 22.8 to 26.4 VDC 2.0 A or less according to the solenoid valve station specification
Solenoid valve connecting specification	Output type PNP (negative common) / source
	Connected load Solenoid valve with surge voltage suppressor of 24 VDC and 1.5 W or less (manufactured by SMC)
	Insulation Power supply for SI unit – Power Supply for solenoid valve
	Residual voltage 0.4 VDC or less

IO-Link communication specifications

Item		Specifications
Protocol		IO-Link version 1.1
Data transmission rate		230.4 Kbps (COM3) or 38.4 kbps (COM2) selectable
Process data minimum cycle time	EX260-SIL1 (in/out 0/4 bytes, COM3)	0.8 ms
	EX260-SIL1 (in/out 0/4 bytes, COM2)	3.4 ms
	EX260-SIL1 (in/out 2/4 bytes, COM3)	1 ms
	EX260-SIL1 (in/out 2/4 bytes, COM2)	5 ms
Process data length		0 byte input/4 bytes output 2 bytes input/4 bytes output (2 bytes input: Device State) (selectable)
Number of outputs		32 outputs
Vendor ID		83 hex
Device ID	EX260-SIL1 (in/out 0/4 bytes, COM3)	158 hex
	EX260-SIL1 (in/out 0/4 bytes, COM2)	159 hex
	EX260-SIL1 (in/out 2/4 bytes, COM3)	15A hex
	EX260-SIL1 (in/out 2/4 bytes, COM2)	15B hex

Applicable solenoid valve series

Solenoid valve series	
SY series	SY3000, SY5000, SY7000
JSY series	JSY1000, JSY3000, JSY5000
VQC series	VQC1000, VQC2000, VQC4000, VQC5000

■Dimensions

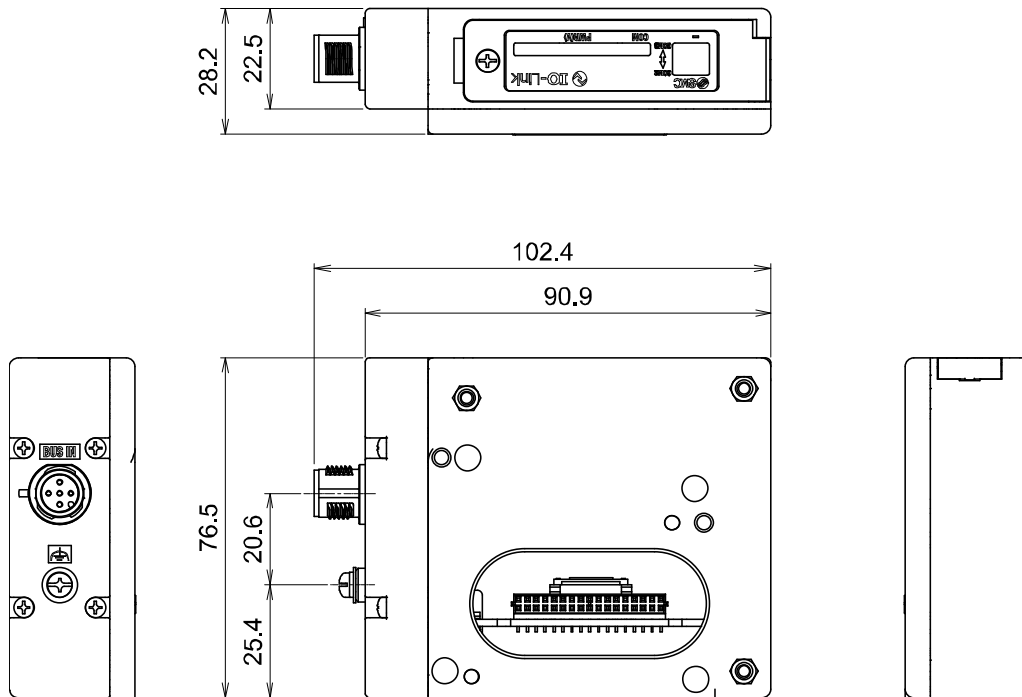

- If a fieldwireable connector is used for the power supply connection, and the SI unit is installed directly to a solenoid valve manifold, the connector should be $\phi 16$ mm or less.
If the connector is a larger diameter it will interfere with the clamping face.

Revision history
A: Contents revised in several places. [June 2022]
B: Contents revised in several places [May 2024]

SMC Corporation

Tel: + 81 3 5207 8249 Fax: +81 3 5298 5362
URL <https://www.smcworld.com>

Note: Specifications are subject to change without prior notice and any obligation on the part of the manufacturer.
© SMC Corporation All Rights Reserved

