



Operation Manual

Solenoid Valve

PRODUCT NAME

25A-JSY1000/3000 Series
(Non Plug-in)

MODEL/ Series

SMC Corporation

Contents

Contents	1
Safety Instructions	2,3
Design / Selection	4, 5
Mounting	5
Piping	6
Wiring	6
Lubrication	7
Air Supply	7
Operating Environment	7
Maintenance	8
Precautions	8
Specific Product Precautions	9 to 13
Valve Construction	14,15
Trouble shooting	16,17



Safety Instructions

These safety instructions are intended to prevent hazardous situations and/or equipment damage. These instructions indicate the level of potential hazard with the labels of "Caution," "Warning" or "Danger." They are all important notes for safety and must be followed in addition to International Standards (ISO/IEC)*1), and other safety regulations.

- *1) ISO 4414: Pneumatic fluid power -- General rules relating to systems.
- ISO 4413: Hydraulic fluid power -- General rules relating to systems.
- IEC 60204-1: Safety of machinery -- Electrical equipment of machines .(Part 1: General requirements)
- ISO 10218: Manipulating industrial robots -Safety.
- etc.

	Caution	Caution indicates a hazard with a low level of risk which, if not avoided, could result in minor or moderate injury.
	Warning	Warning indicates a hazard with a medium level of risk which, if not avoided, could result in death or serious injury.
	Danger	Danger indicates a hazard with a high level of risk which, if not avoided, will result in death or serious injury.

Warning

1. The compatibility of the product is the responsibility of the person who designs the equipment or decides its specifications.

Since the product specified here is used under various operating conditions, its compatibility with specific equipment must be decided by the person who designs the equipment or decides its specifications based on necessary analysis and test results.

The expected performance and safety assurance of the equipment will be the responsibility of the person who has determined its compatibility with the product.

This person should also continuously review all specifications of the product referring to its latest catalog information, with a view to giving due consideration to any possibility of equipment failure when configuring the equipment.

2. Only personnel with appropriate training should operate machinery and equipment.

The product specified here may become unsafe if handled incorrectly.

The assembly, operation and maintenance of machines or equipment including our products must be performed by an operator who is appropriately trained and experienced.

3. Do not service or attempt to remove product and machinery/equipment until safety is confirmed.

1. The inspection and maintenance of machinery/equipment should only be performed after measures to prevent falling or runaway of the driven objects have been confirmed.

2. When the product is to be removed, confirm that the safety measures as mentioned above are implemented and the power from any appropriate source is cut, and read and understand the specific product precautions of all relevant products carefully.

3. Before machinery/equipment is restarted, take measures to prevent unexpected operation and malfunction.

4. Contact SMC beforehand and take special consideration of safety measures if the product is to be used in any of the following conditions.

1. Conditions and environments outside of the given specifications, or use outdoors or in a place exposed to direct sunlight.

2. Installation on equipment in conjunction with atomic energy, railways, air navigation, space, shipping, vehicles, military, medical treatment, combustion and recreation, or equipment in contact with food and beverages, emergency stop circuits, clutch and brake circuits in press applications, safety equipment or other applications unsuitable for the standard specifications described in the product catalog.

3. An application which could have negative effects on people, property, or animals requiring special safety analysis.

4. Use in an interlock circuit, which requires the provision of double interlock for possible failure by using a mechanical protective function, and periodical checks to confirm proper operation.



Safety Instructions

Caution

The product is provided for use in manufacturing industries.

The product herein described is basically provided for peaceful use in manufacturing industries.

If considering using the product in other industries, consult SMC beforehand and exchange specifications or a contract if necessary.

If anything is unclear, contact your nearest sales branch.

Limited warranty and Disclaimer/Compliance Requirements

The product used is subject to the following "Limited warranty and Disclaimer" and "Compliance Requirements".

Read and accept them before using the product.

Limited warranty and Disclaimer

1. The warranty period of the product is 1 year in service or 1.5 years after the product is delivered, whichever is first. *2)

Also, the product may have specified durability, running distance or replacement parts. Please consult your nearest sales branch.

2. For any failure or damage reported within the warranty period which is clearly our responsibility, a replacement product or necessary parts will be provided.

This limited warranty applies only to our product independently, and not to any other damage incurred due to the failure of the product.

3. Prior to using SMC products, please read and understand the warranty terms and disclaimers noted in the specified catalog for the particular products.

*2) Vacuum pads are excluded from this 1 year warranty.

A vacuum pad is a consumable part, so it is warranted for a year after it is delivered.

Also, even within the warranty period, the wear of a product due to the use of the vacuum pad or failure due to the deterioration of rubber material are not covered by the limited warranty.

Compliance Requirements

1. The use of SMC products with production equipment for the manufacture of weapons of mass destruction (WMD) or any other weapon is strictly prohibited.

2. The exports of SMC products or technology from one country to another are governed by the relevant security laws and regulation of the countries involved in the transaction. Prior to the shipment of a SMC product to another country, assure that all local rules governing that export are known and followed.

Caution

SMC products are not intended for use as instruments for legal metrology.

Measurement instruments that SMC manufactures or sells have not been qualified by type approval tests relevant to the metrology (measurement) laws of each country.

Therefore, SMC products cannot be used for business or certification ordained by the metrology (measurement) laws of each country.



Precautions for 5 Port Solenoid Valve 1

Be sure to read before handling. Refer to main text for detailed precautions on every series.

Design / Selection

Warning

1. Confirm the specifications

Products represented in this instruction manual are designed only for use in compressed air systems (including vacuum). Do not operate at pressures or temperatures, etc., beyond the range of specifications, as this can cause damage or malfunction.

We do not guarantee against any damage if the product is used outside of the specification range.

2. Actuator drive

When an actuator, such as a cylinder, is to be driven using a valve, take appropriate measures (such as the installation of a cover or the restricting of access to the product) to prevent potential danger caused by actuator operation.

3. Intermediate stops

For 3-position closed center, it is difficult to make the piston stop at the required position accurately due to the compressibility of air.

Furthermore, since valves and cylinders are not guaranteed for zero air leakage, it may not be possible to hold a stopped position for an extended period of time.

4. Effect of back pressure when using a manifold.

Use caution when valves are used on a manifold because actuator may malfunction due to back-pressure. Especially when using a 3-position exhaust center valve or a single acting cylinder, take appropriate measures to prevent the malfunction by using it with an individual exhaust manifold.

5. Holding pressure (including vacuum).

Since the valve are subject to air leakage, they cannot be used for applications such as holding pressure (including vacuum) in a pressure vessel.

6. Not suitable for use as an emergency shut-off valve, etc.

The valves listed in this instruction manual are not designed for safety applications such as an emergency shutoff valve. If the valves are used for the mentioned applications, additional safety measures should be adopted.

7. Release of residual pressure

For maintenance and inspection purposes install a system for releasing residual pressure. Especially in the case of 3-position closed center valve, ensure that the residual pressure between the valve and the cylinder is released.

8. Operation in a vacuum condition

When a valve is used for switching a vacuum, take measures to install a suction filter or similar to prevent external dust or other foreign matter from entering inside the valve.

In addition, at the time of vacuum adsorption, be sure to supply a constant supply of vacuum. Failure to do so may result in foreign matter sticking to the adsorption pad or air leakage, causing the workpiece to drop.

9. Regarding a vacuum switch valves and vacuum release valves

If a non-vacuum valve is installed in the middle of a piping system that contains a vacuum, the vacuum condition will not be maintained. Use a valve designed for use under vacuum conditions.

10. Double solenoid type

When using the double solenoid type for the first time, actuators may travel in an unexpected direction depending on the switching position of the valve. Implement measures to prevent any danger from occurring when operating the actuator.

11. Ventilation

Provide ventilation when using a valve in a confined area, such as in a closed control panel. For example, install a ventilation opening, etc. in order to prevent pressure from increasing inside of the confined area and to release the heat generated by the valve.

12. Extended periods of continuous energization

- If a valve will be continuously energized for an extended period of time, the temperature of the valve will increase due to the heat generated by the coil assembly.

This will likely adversely affect the performance of the valve and any nearby peripheral equipment.

Therefore, if the valve is to be energized for periods of longer than 30 minutes at a time or if during the hours of operation the energized period per day is longer than the de-energized period, we advise using a valve with specifications listed below.

- Pilot operated: A 0.4 W or lower valve, such as the SY/JSY series, or a valve with a power-saving circuit
- Direct operated: A continuous duty type valve such as the VK series or the VT series If conflicting instructions are given in the "Specific Product Precautions" or on the "How to Order Valves" page, give them priority.

13. Do not disassemble the product or make any modifications, including additional machining.

Doing so may cause human injury and/or an accident.

14. Resumption after a long period of holding time

When resuming operation after a long period of holding time, there are cases in which, regardless of whether the product is in an ON or OFF state, there is a delay in the initial response time due to adhesion.

Conducting several cycles of running-in operation will solve this problem. Please consider implementing this before resumption.

Caution

1. Precautions for 2-position double solenoid valves

If a double solenoid valve is operated with momentary energization, it should be energized for at least 0.1 seconds. However, depending on the piping conditions, the cylinder may malfunction even when the double solenoid valve is energized for 0.1 seconds or longer. In this case, energize the double solenoid valve until the cylinder is exhausted completely.

2. Leakage voltage

Take note that the leakage voltage will increase when a resistor is used in parallel with a switching element or when a C-R circuit (surge voltage suppressor) is used for protecting a switching device because of the leakage voltage passing through the C-R circuit.

The suppressor residual leakage voltage should be as 3% or less of the rated voltage.

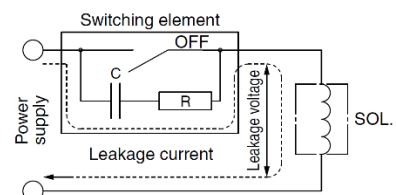



25A-JSY1000/3000 Series

Precautions for 5 Port Solenoid Valve 2

Be sure to read before handling. Refer to main text for detailed precautions on every series.

Design / Selection

⚠ Caution

3. Surge voltage suppressor

- 1) The surge voltage suppressor built into the valve is intended to protect the output contacts so that the surge generated inside valve does not adversely affect the output contacts. Therefore, if an overvoltage or overcurrent is received from an external peripheral device, the surge voltage protection element inside the valve is overloaded, causing the element to break. In the worst case, the breakage causes the electric circuit to enter short-circuit status. If energizing continues while in this state, a large current flows. This may cause secondary damage to the output circuit, external peripheral device, or valve, and may also cause a fire. So, take appropriate protective measures, such as the installation of an overcurrent protection circuit in the power supply or a drive circuit to maintain a sufficient level of safety.
- 2) If a surge protection circuit contains nonstandard diodes, such as Zener diodes or varistor, a residual voltage that is in proportion to the protective circuit and the rated voltage will remain. Therefore, take into consideration the surge voltage protection of the controller. In the case of diodes, the residual voltage is approximately 1V.

4. Surge voltage intrusion

With non-polar type solenoid valves, at times of sudden interruption of the loading power supply, such as emergency shutdown, surge voltage intrusion may be generated from loading equipment with a large capacity (power consumption), and a solenoid valve in a de-energized state may switch over (see Figure 1).

When installing a breaker circuit for the loading power supply, consider using a solenoid valve with polarity (with polarity protection diode), or install a surge absorption diode between the loading equipment COM line and the output equipment COM line (see Figure 2).

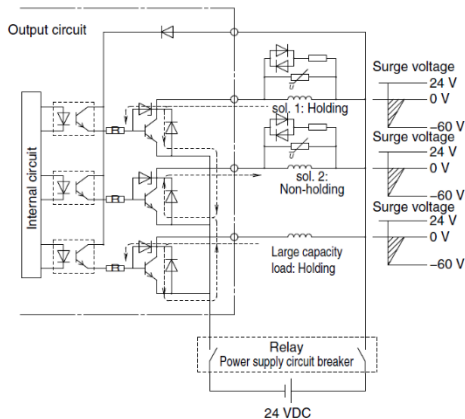

Figure 1. Surge intrusion circuit example (NPN outlet example)

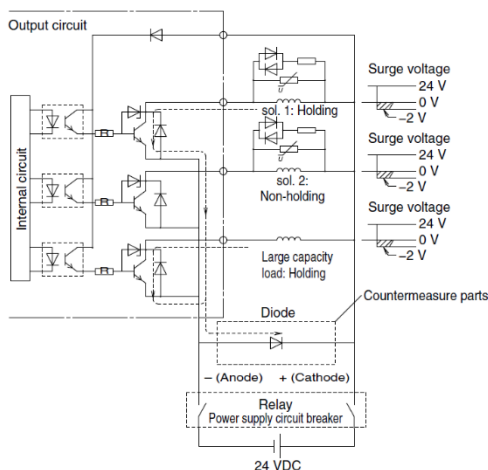

Figure 2. Surge intrusion countermeasure example (NPN outlet example)

5. Operation in low temperature conditions

It is possible to operate a valve in extreme temperatures, as low as -10°C . Take appropriate measures to avoid the freezing of drainage, moisture, etc., in low temperatures.

6. Operation for air blowing

When using a solenoid valve for air blowing, use an external pilot type. Use caution because the pressure drop caused by the air blowing can have an effect on the internal pilot type valve when internal pilot type valves and external pilot type valves are used on the same manifold.

Additionally, when compressed air within the pressure range of the established specifications is supplied to the external pilot type valve's port, and a double solenoid valve is used for air blowing, the solenoids should be energized when air is being blown.

7. Mounting orientation

Mounting orientation is universal.

8. Initial lubrication of main valve

The initial lubricant (Grease) has already been applied to the main valve.

9. For the pilot EXH (PE) port

If the solenoid valve and the manifold's pilot EXH (PE) port is restricted extremely or blocked, abnormal operation of the solenoid valve may occur.

Mounting

⚠ Warning

1. Operation manual

Install the products and operate them only after reading the operation manual carefully and understanding its contents. Also, keep the manual where it can be referred to as necessary.

2. Ensure sufficient space for maintenance activities.

When installing the products, allow access for maintenance and inspection.

3. Tighten threads with the proper tightening torque.

When installing the products, follow the listed torque specifications.

4. If air leakage increases or equipment does not operated properly, stop operation.

Check mounting conditions when air and power supplies are connected. Initial function and leakage tests should be performed after installation.

5. Painting and coating

Warnings or specifications printed on or affixed to the product should not be erased, removed or covered up.

Also, applying paint to resinous parts may have an adverse effect due to the solvent in the paint.



Precautions for 5 Port Solenoid Valve 3

Be sure to read before handling. Refer to main text for detailed precautions on every series.

Piping

⚠ Caution

1. Refer to the Fittings and Tubing Precautions for handling one-touch fittings.

2. Preparation before piping

Before piping is connected, it should be thoroughly blown out with air (flushing) or washed to remove chips, cutting oil, and other debris from inside the pipe.

3. Winding of sealant tape

When screwing piping or fittings into ports, ensure that chips from the pipe threads or sealing material do not enter the piping. Also, if sealant tape is used, leave 1 thread ridge exposed at the end of the threads.

4. Closed center and double check valve types

For the closed center or double check valve types, check the piping to prevent air leakage from the piping between the valve and the cylinder.

5. Connection of piping and fittings

When screwing piping or fittings into the valve, tighten them as follows.

1) When using SMC's M3 or M5 fittings, follow the procedures below to tighten them.

● Connection thread: M3

First, tighten by hand, then use a suitable wrench to tighten the hexagonal portion of the body an additional 1/4 turn. The reference value for the tightening torque is 0.4 to 0.5 N·m.

● Connection thread: M5

First, tighten by hand, then use a suitable wrench to tighten the hexagonal portion of the body an additional 1/6 to 1/4 turn.

The reference value for the tightening torque is 1 to 1.5 N·m.

* Excessive tightening may damage the thread portion or deform the gasket and cause air leakage. Insufficient tightening may loosen the threads or cause air leakage.

● When using a fitting other than an SMC fitting, follow the instructions given by the fitting manufacturer.

Follow the fitting maker instructions.

2) For a fitting with sealant R or NPT, first, tighten it by hand, then use a suitable wrench to tighten the hexagonal portion of the body an additional two or three turns. For the tightening torque, refer to the table below.

Connection thread size (R, NPT)	Proper tightening torque (N·m)
1/16	2 to 3
1/8	3 to 5
1/4	8 to 12
3/8	15 to 20

3) If the fitting is tightened with excessive torque, a large amount of sealant will seep out. Remove the excess sealant.

4) Insufficient tightening may cause seal failure or loosen the threads.

5) For reuse

(1) Normally, fittings with a sealant can be reused up to 2 to 3 times.

(2) To prevent air leakage through the sealant, remove any loose sealant stuck to the fitting by blowing air over the threaded portion.

(3) If the sealant no longer provides effective sealing, wind sealing tape over the sealant before reusing. Do not use any form of sealant other than the tape type of sealant.

(4) Once the fitting has been tightened, backing it out to its original position often causes the sealant to become defective. Air leakage will occur.

6. Uni thread fittings

1) First, tighten the threaded portion by hand, then use a suitable wrench to tighten the hexagonal portion of the body further at wrench tightening angle shown below. For the reference value for the tightening torque, refer to the table below.

Connection Female Thread: Rc, NPT, NPTF

Uni thread size	Wrench tightening angle after tightened by hand (deg)	Tightening torque (N·m)
1/8	30 to 60	3 to 5
1/4	30 to 60	8 to 12
3/8	15 to 45	14 to 16

Connection Female Thread: G

Uni thread size	Wrench tightening angle after tightened by hand (deg)	Tightening torque (N·m)
1/8	30 to 45	3 to 4
1/4	15 to 30	4 to 5
3/8	15 to 30	8 to 9

2) The gasket can be reused up to 6 to 10 times. It can be replaced easily when it has sustained damage. A broken gasket can be removed by holding it and then turning it in the same direction as loosening the thread. If the gasket is difficult to remove, cut it with nippers, etc. In such a case, use caution not to scratch the seat face because the seat face of the fitting's 45° gasket is the sealing face.

7. Piping to products

When piping to a product, avoid mistakes regarding the supply port, etc.

Wiring

⚠ Warning

1. The solenoid valve is an electrical product. For safety, install an appropriate fuse and circuit breaker before use.

⚠ Caution

1. Polarity

When connecting power to a solenoid valve with a DC specification and equipped with a light or surge voltage suppressor, check for polarity. If there is polarity, take note of the following.

No diode to protect polarity.

If a mistake is made regarding the polarity, damage may occur to the diode in the valve, the switching element in a control device or power supply equipment, etc.

With diode to protect polarity.

If polarity connection is wrong, the valve will not operate.

2. Applied voltage

When electric power is connected to a solenoid valve, be careful to apply the proper voltage. Improper voltage may cause malfunction or coil damage.

3. Check the connections.

Check if the connections are correct after completing all wiring.



Precautions for 5 Port Solenoid Valve 4

Be sure to read before handling. Refer to main text for detailed precautions on every series.

Lubrication

Warning

1. Lubrication

- 1) The valve has been lubricated for life by the factory and does not require any further.
- 2) If a lubricant is used in the system, use class 1 (no additives) and class 2 (with additives) ISO VG32 turbine oil. For details about lubricant manufacturers' brands, refer to the SMC website. Once lubricant is utilized within the system, since the original lubricant applied within the product during manufacturing will be washed away, please continue to supply lubrication to the system. Without continued lubrication, malfunctions could occur.
If turbine oil is used, refer to the Safety Data Sheet (SDS) of the oil.

2. Lubrication amount

If the lubrication amount is excessive, the oil may accumulate inside the pilot valve, causing malfunction or response delay. So, do not apply a large amount of oil. When a large amount of oil needs to be applied, use an external pilot type to put the supply air on the pilot valve side in the non-lube state. This prevents the accumulation of oil inside the pilot valve.

Air Supply

Warning

1. Type of fluids

Be sure to use compressed air for the fluid.

2. When there is a large amount of drainage.

Compressed air containing a large amount of drainage can cause malfunction of pneumatic equipment. An air dryer or water separator should be installed upstream from filters.

3. Drain flushing

If condensation in the drain bowl is not emptied on a regular basis, the bowl will overflow and allow the condensation to enter the compressed air lines. It causes malfunction of pneumatic equipment. If the drain bowl is difficult to check and remove, installation of a drain bowl with an auto drain option is recommended.

For compressed air quality, refer to SMC's Best Pneumatics catalog.

4. Use clean air

Do not use compressed air that contains chemicals, synthetic oils including organic solvents, salt or corrosive gasses, etc., as it can cause damage or malfunction.

Caution

1. Install an air filter.

Install an air filter upstream near the valve. Select an air filter with a filtration size of 5 µm or smaller.

2. Take measures to ensure air quality, such as by installing an aftercooler, air dryer, or water separator.

Compressed air that contains a large amount of drainage can cause the malfunction of pneumatic equipment, such as valves. Therefore, take appropriate measures to ensure air quality, such as by providing an aftercooler, air dryer, or water separator.

3. If an excessive amount of carbon powder is present, install a mist separator on the upstream side of the valve.

If excessive carbon dust is generated by the compressor, it may adhere to the inside of a valve and cause it to malfunction.

For compressed air quality, refer to the SMC Best Pneumatics catalog.

Operating Environment

Warning

1. Do not use in an atmosphere containing corrosive gases, chemicals, sea water, water, water steam, or where there is direct contact with any of these.
2. Do not use in an environment where flammable gas or explosive gas exists. Usage may cause a fire or explosion. The products do not have an explosion proof construction.
3. Do not use in a place subject to heavy vibration and/or shock.
4. The valve should not be exposed to prolonged sunlight. Use a protective cover. Note that the valve is not for outdoor use.
5. Remove any sources of excessive heat.
6. If it is used in an environment where there is possible contact with oil, weld spatter, etc., exercise preventive measures.
7. When the solenoid valve is mounted in a control panel or it's energized for a long period of time, make sure the ambient temperature is within the specifications of the valve.

Caution

1. Temperature of ambient environment

Use the valve within the range of the ambient temperature specification of each valve. In addition, pay attention when using the valve in environments where the temperature changes drastically.

2. Humidity of ambient environment

- When using the valve in environments with low humidity, take measures to prevent static.
- If the humidity rises, take measures to prevent the adhesion of water droplets on the valve.



25A-JSY1000/3000 Series

Precautions for 5 Port Solenoid Valve 5

Be sure to read before handling. Refer to main text for detailed precautions on every series.

Maintenance

Warning

- 1. Perform maintenance and inspection according to the procedures indicated in the operation manual.**

If handled improperly, human injury and/or malfunction or damage of machinery and equipment may occur.
- 2. Removal of equipment, and supply/exhaust of compressed air**

Before components are removed, first confirm that measures are in place to prevent workpieces from dropping, run-away equipment, etc. Then, cut off the supply air and electric power, and exhaust all air pressure from the system using the residual pressure release function.

For the 3-position closed center, exhaust the residual pressure between the valve and the cylinder. When the equipment is operated after remounting or replacement, first confirm that measures are in place to prevent the lurching of actuators, etc. Then, confirm that the equipment is operating normally. In particular, when a 2-position double solenoid valve is used, releasing residual pressure rapidly may cause the spool valve to malfunction, depending on the piping conditions, or the connected actuator to operate.
- 3. Low-frequency operation**

Valves should be operated at least once every 30 days to prevent malfunction. (Use caution regarding the air supply.)
- 4. Manual override**

When a manual override is operated, connected equipment will be actuated.

Operate only after safety is confirmed
- 5. If the volume of air leakage increases or the valve does not operate normally, do not use the valve.**

Perform periodic maintenance on the valve to confirm the operating condition and check for any air leakage.

Caution

- 1. Drain flushing**

Remove drainage from the air filters regularly.
- 2. Lubrication**

In the case of rubber seals, once lubrication has been started, it must be continued.

Use class 1 (no additives) and class 2 (with additives) ISO VG32 turbine oil. For details about lubricant manufacturers' brands, refer to the SMC website. If other lubricant oil is used, it may cause a malfunction.
- 3. Manual override operation**

When switching a double solenoid valve via the manual override operation, instantaneous operation may cause the malfunction of the cylinder. It is recommended that the manual override be held until the cylinder reaches the stroke end position.

Precautions

Caution

■ Change of material

For the 25A- series, there is a restriction on the use of copper and zinc as main components in the metal materials used. Keep in mind that the aluminum alloy, aluminum die cast, and some of the stainless steel materials contain traces of copper (Cu) and/or zinc (Zn) as an additive element.

However, copper is used in some parts—the coils of solenoid valves, the circuit boards, connector pins, and lead wires of electrical equipment and auto switches, and the motors, cables, and drivers of electric ctuators—whose materials cannot be easily changed to alternative materials.



25A-JSY1000/3000 series

Specific Product Precautions 1

Be sure to read this before handling.

Environment

Warning

Do not use valves in atmospheres of corrosive gases, chemicals, sea water, water, water vapor, or where there is direct contact with any of these.

Valve Mounting

Caution

Mount it so that there is no slippage or deformation in gaskets, and tighten with the tightening torque as shown on the below.

Series	Thread size	Tightening torque
25A-JSY1000	M1.4	0.06 N·m
25A-JSY3000	M2	0.16 N·m

Manual Override

Warning

- Do not apply excessive torque when turning the manual override. [0.05 N·m]
When locking the manual override, be sure to push it down before turning. Turning without first pushing it down can cause damage to the manual override and other trouble such as air leakage, etc.
- Manual override is used to switch the main valve without inputting an electrical signal for the valve. Connected actuator is started by manual operation. Use the manual override after confirming that there is no danger.

Non-locking push type

Push down on the manual override button until it stops.

25A-JSY1000 series

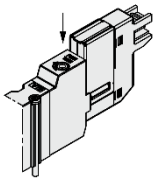

25A-JSY3000 series

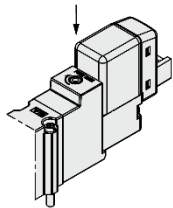

Caution

Push-turn locking slotted type [D type]

Push down on the manual override with a small flat head screwdriver until it stops, and then turn it 90° clockwise. The manual override is then locked. To release it, turn it counterclockwise. If it is not turned, it can be operated the same way as the nonlocking push type.

25A-JSY1000 series

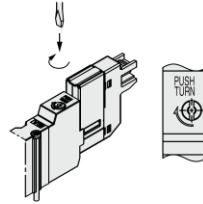

Locked position

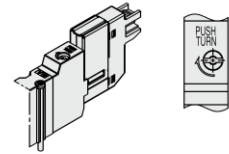

25A-JSY3000 series

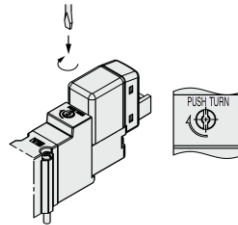

Locked position

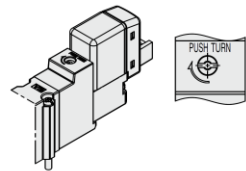

Push-turn locking lever type [E type]

Push down on the manual override by finger until it stops, and then turn it 90° clockwise. The manual override is then locked. To release it, turn it counterclockwise. If it is not turned, it can be operated the same way as the nonlocking push type.

25A-JSY1000 series

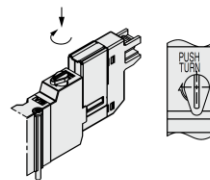

Locked position

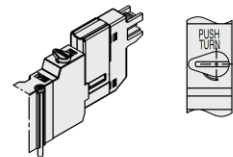

Carefully check the manual override projection amount.
Max. (at OFF): 3.2 mm

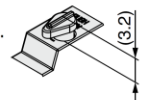

25A-JSY3000 series

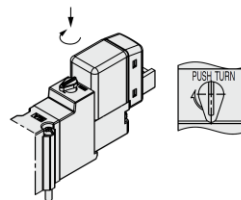

Locked position

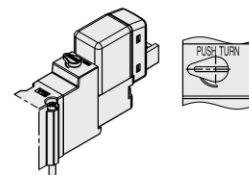

Carefully check the manual override projection amount.
Max. (at OFF): 3.2 mm

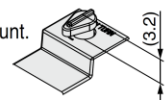



25A-JSY1000/3000 series Specific Product Precautions 2

Be sure to read this before handling.

Used as a 3-Port Valve

⚠ Caution

■ **In case of using a 5-port valve as a 3-port valve**
The 25A-JSY1000/3000 series can be used as normally closed (N.C.) or normally open (N.O.) 3-port valves by closing one of the cylinder ports 4(A) or 2(B) with a plug. However, they should be used with the exhaust ports kept open.

Plug position	B port	A port
Type of actuation	N.C.	N.O.
Number of solenoids	Single	(A)4 2(B) (EA)5 1 3(EB) (P)
	Double	(A)4 2(B) (EA)5 1 3(EB) (P)

How to Use Plug Connector

⚠ Caution

1. Attaching and detaching connectors

- To attach a connector, hold the lever and connector unit between your fingers and insert straight onto the pins of the solenoid valve so that the lever's pawl is pushed into the groove and locks.
- To detach a connector, remove the pawl from the groove by pushing the lever downward with your thumb, and pull the connector straight out.

For 25A-JSY1000

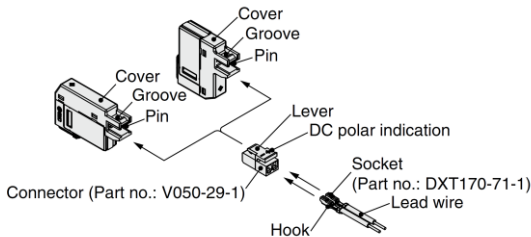

* In order not to damage the connector and cover, do not pull the lead wire excessively (with a force of 10 N or more).

For 25A-JSY3000

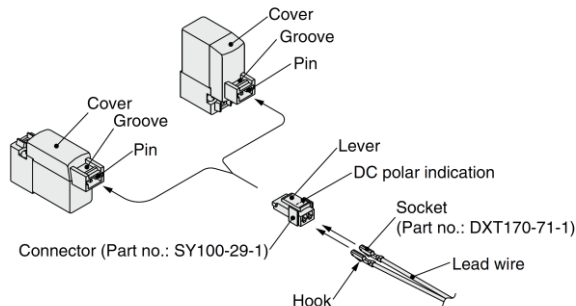

* In order not to damage the connector and cover, do not pull the lead wire excessively (with a force of 30 N or more).

2. Crimping connection of lead wire and socket

Strip 3.2 to 3.7 mm at the end of lead wires, insert the end of the core wires evenly into the sockets, and then crimp it by a crimping tool. When this is done, take care that the coverings of the lead wires do not enter the core wire crimping area.

(Crimping tools are available for rent at SMC. Part No.DXT170-75-1)

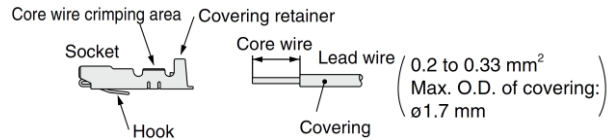

3. Attaching and detaching lead wires with sockets

• Attaching

Insert the sockets into the square holes of the connector (⊕, ⊖ indication), and continue to push the sockets all the way in until they lock by hooking into the seats in the connector.

(When they are pushed in, their hooks open and they are locked automatically.)

Then confirm that they are locked by pulling lightly on the lead wires.

• Detaching

To detach a socket from a connector, pull out the lead wire while pressing the socket's hook with a stick having a thin tip (approx. 1 mm).

If the socket will be used again, first spread the hook outward.

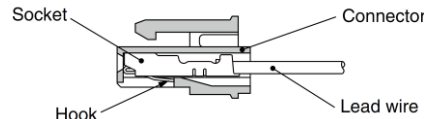



25A-JSY1000/3000 series Specific Product Precautions 3

Be sure to read this before handling.

Plug Connector

How to Order

■ For 25A-JSY1000

V050-30-□A-□

● Rated voltage

Symbol	Rated voltage	Lead wire color
4	DC	Red, Black
Nil	Without lead wire*1	

*1 With connector and 2 of sockets only

● Lead wire length

Symbol	Lead wire length
Nil	300 mm
6	600 mm
10	1000 mm
20	2000 mm
30	3000 mm
50	5000 mm

■ For 25A-JSY3000

SY100-30-□A-□

● Rated voltage

Symbol	Rated voltage	Lead wire color
4	DC	Red, Black
Nil	Without lead wire*1	

*1 With connector and 2 of sockets only

● Lead wire length

Symbol	Lead wire length
Nil	300 mm
6	600 mm
10	1000 mm
20	2000 mm
30	3000 mm
50	5000 mm

How to Order

Specify the plug connector part number together with the part number for the plug connector type solenoid valve without connector.

<Example> Lead wire length 2000 mm

For DC
25A-JSY3140-5LOZ
SY100-30-4A-20

Surge Voltage Suppressor

⚠ Caution

<For DC>

L/M Plug Connector

■ Polar type (For 25A-JSY3000)

With light/surge voltage suppressor (□Z)

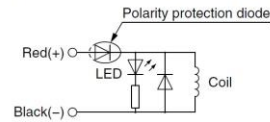

- Connect in accordance with the +, - polarity indication.
- When wiring is done at the factory, positive (+) is red and negative (-) is black.

■ With power saving circuit (25A-JSY3000 Made to Order)

Power consumption is decreased to approx. 1/2.5 to 1/4 of the amount consumed at startup by reducing the wattage required to hold the valve in an energized state. (Effective energizing time is over 62 ms at 24 VDC.)

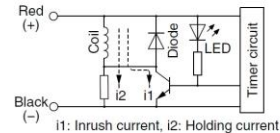

The circuit shown above reduces the power consumption for holding in order to save energy. Refer to the electrical power waveform as shown below.

<Electrical power waveform with power saving circuit>

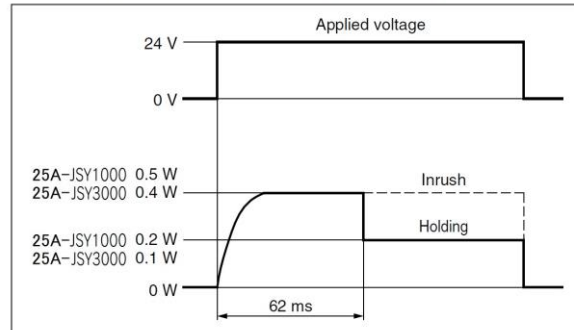

- Be careful not to reverse the polarity, since a diode to prevent the reversed current is not provided for the power saving circuit.
- Since the voltage will drop by approx. 0.5 V due to the transistor, pay attention to the allowable voltage fluctuation. (For details, refer to the solenoid specifications of each type of valve.)



25A-JSY1000/3000 series Specific Product Precautions 4

Be sure to read this before handling.

Continuous Duty

⚠ Caution

If a valve is energized continuously for long periods of time, the rise in temperature due to heat-up of the coil assembly may cause a decline in solenoid valve performance, reduce service life, or have adverse effects on peripheral equipment. If the valve is energized continuously for long periods of time, be sure to use a valve with power saving circuit. In particular, if three or more adjacent stations on the manifold are energized simultaneously for extended periods of time or if the valves on A side and B side are energized simultaneously for long periods of time, take special care as the temperature rise will be greater.

Energization of a 2-Position Double Solenoid Valve

⚠ Caution

To avoid operation failure, do not energize the A side and B side of 2-position double solenoid valve at the same time.

How to Replace One-touch Fittings

⚠ Caution

By replacing One-touch fittings of manifold base, it is possible to change the connection diameter of the 4(A), 2(B), 1(P), 3/5(E) ports.

When replacing the One-touch fittings, remove the clip or the plate before pulling the One-touch fittings off. Mount the One-touch fittings by following the removal procedure in reverse.

Use caution as it may cause air leakage if the clip and the plate are not inserted securely enough when they are switched. Refer to page 18 for part numbers of One-touch fittings. Fitting direction is specified when the fittings below are used. Assemble the fitting so that the D-cut surfaces of the fitting face sideways.

Fitting part no.:

- 25A-KQSY10-C4-X1336 (25A-JSY1000)
- 25A-KQSY11-C6-X1336 (25A-JSY1000)
- 25A-KQSY30-C8-X1336 (25A-JSY3000)

■ Metal base

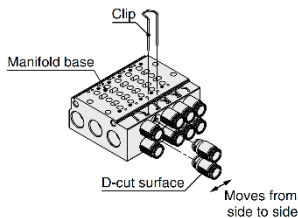

* It is not possible to replace C4 fittings with C6 fittings for the 25A-JSY1000 series.

One-touch Fittings

⚠ Caution

■ Tube attachment/detachment for One-touch fittings

1) Tube attachment

1. Take a tube having no flaws on its periphery and cut it off at a right angle. When cutting the tube, use tube cutters TK-1, 2 or 3. Do not use pliers, nippers or scissors, etc. If cutting is done with tools other than tube cutters, the tube may be cut diagonally or become flattened, etc., making a secure installation impossible, and causing problems such as the tube pulling out after installation or air leakage. Allow some extra length in the tube.
2. Grasp the tube and push it in slowly, inserting it securely all the way into the fitting.
3. After inserting the tube, pull on it lightly to confirm that it will not come out. If it is not installed securely all the way into the fitting, this can cause problems such as air leakage or the tube pulling out.

2) Tube detachment

1. Push in the release button sufficiently, pushing its collar equally around the circumference.
2. Pull out the tube while holding down the release button so that it does not come out. If the release button is not pressed down sufficiently, there will be increased bite on the tube and it will become more difficult to pull it out.
3. When the removed tube is to be used again, cut off the portion which has been chewed before reusing it. If the chewed portion of the tube is used as is, this can cause trouble such as air leakage or difficulty in removing the tube.

Applicable Fittings: KQ2H, KQ2S, M Series

Series	Model	Piping port	Port size	Fitting	Applicable tubing O.D.					
					ø2	ø4	ø6	ø8	ø10	ø12
25A-JSY1000	25A-JJ5SY1-40 Manifold base	1P, 5EA 3EB	1/8	KQ2H						
				KQ2S						
		4A, 2B	M5	KQ2H						
				KQ2S						
			M3	KQ2H						
				KQ2S						

Series	Model	Piping port	Port size	Fitting	Applicable tubing O.D.					
					ø2	ø4	ø6	ø8	ø10	ø12
25A-JSY3000	25A-JJ5SY3-40 Manifold base	1P, 5EA 3EB	1/4	KQ2H						
				KQ2S						
		4A, 2B	1/8	KQ2H						
				KQ2S						
			M5	KQ2H						
				KQ2S						



25A-JSY1000/3000 series

Specific Product Precautions 5

Be sure to read this before handling.

Other Tube Brands

Caution

When using other than SMC brand tube, confirm that the following specifications are satisfied with respect to the tube outside diameter tolerance.

- | | |
|----------------------|---------------------------------------|
| 1) Nylon tube | within ± 0.1 mm |
| 2) Soft nylon tube | within ± 0.1 mm |
| 3) Polyurethane tube | within $+0.15$ mm
within -0.2 mm |

Do not use tube which do not meet these outside diameter tolerances. It may not be possible to connect them, or they may cause other trouble, such as air leakage or the tube pulling out after connection.

Fixation of DIN Rail Mounting Type Manifolds

Caution

1. When the manifold is fixed with bolts on a mounting surface etc., it can be operated just by fixing on both ends of the DIN rail if the bottom surface of the DIN rail is entirely in contact with the mounting surface when mounted horizontally. However, if it is used with other mounting or with side or reverse mounting, fix the DIN rail with bolts at regular intervals. As a guide, insert bolts in 2 locations for 2-5 stations, 3 locations for 6-10 stations, 4 locations for 11-15 stations, and 5 locations for 16-20 stations.
2. When using the manifold with DIN rail in an environment where any vibration or impact is applied to it, the DIN rail itself may be broken. In particular, if the installation surface vibrates when mounting the manifold on the wall or if a load is directly applied to the manifold, the DIN rail may be broken, causing the manifold to drop. When any vibration, impact, or load is applied to the manifold, be sure to use the direct mounting manifold. the direct mounting manifold.

Installation

Caution

Even though the inlet pressure is within the operating pressure range, when the piping diameter is restricted due to size reduction of supply port (P), the flow will be insufficient. In this case, the valve does not switch completely and the cylinder may malfunction.

Valve construction

Rubber Seal

2-position single

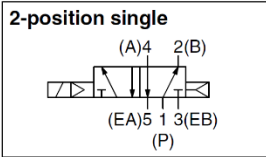
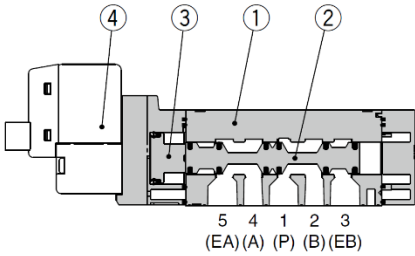

2-position double

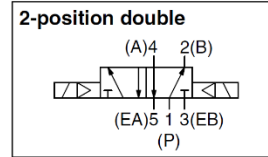
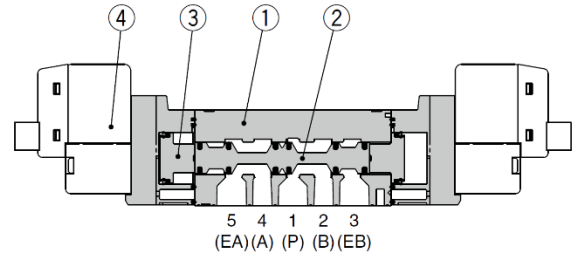

3-position closed center/exhaust center/pressure center

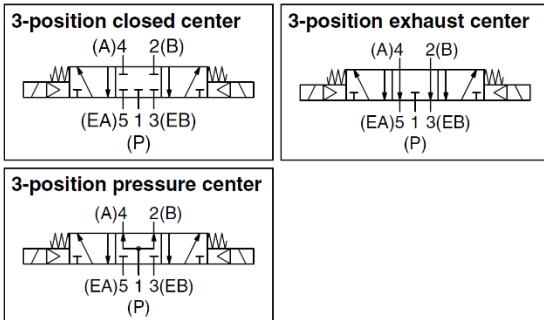
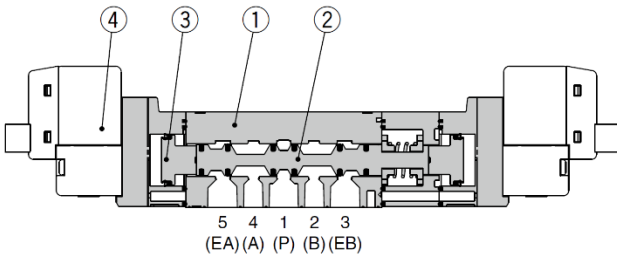

4-position dual 3-port valve

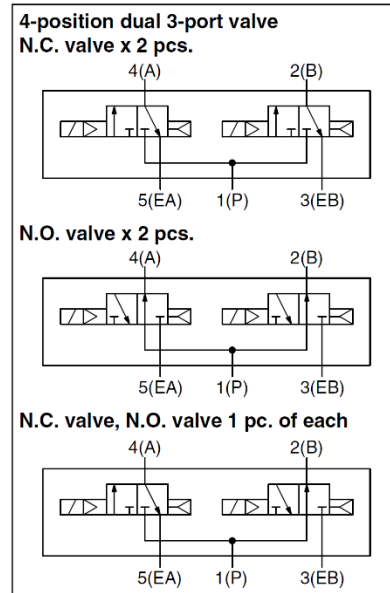
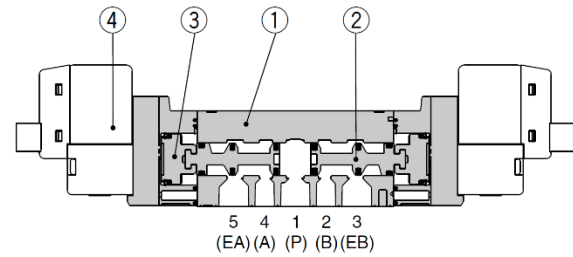

Component Parts

No.	Description	Material
1	Body	Aluminum die-casted
2	Spool valve	Aluminum/HNBR (4-position solenoid valve: Resin/HNBR)
3	Piston	Resin
4	Pilot valve assembly	—

25A-JSY1000/3000 Series Manifold Options

Blanking plate assembly

(With two mounting screws)

Used when valve additions are expected or for maintenance. A structure is in place on the blanking plate to prevent the mounting screws from sliding.

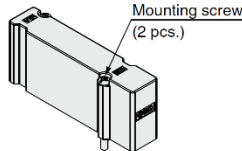

How to Order Blanking Plate Assembly

25A-JSY **3** 1M-26-1A

Series

1	JSY1000
3	JSY3000

Valve Mounting Screw Part No.

Description	Part no.		Note
	25A-JJ5SY1	25A-JJ5SY3	
Round head combination screw	25A-JSY11V-23-4A	25A-JSY31V-23-4A	Part numbers shown on the left are for 10 valves. (20 pcs.)

One-touch Fittings Part Nos.

		Port size	25A-JSY1000	25A-JSY3000
A, B port	Metric size	ø4 One-touch fitting (Straight type)	25A-KQSY10-C4-X1336	25A-KQSY30-C4
		ø6 One-touch fitting (Straight type)	25A-KQSY11-C6-X1336	25A-KQSY30-C6
		ø8 One-touch fitting (Straight type)	—	25A-KQSY30-C8-X1336

How to Order Individual SUP/EXH Spacer Assembly

One-touch fitting
Straight type

25A-JSY **3** 1M-**38**-1A-**C6**

Series

1	JSY1000
3	JSY3000

Spacer type

38	Individual SUP spacer
39	Individual EXH spacer

Port size (Metric)

Symbol	P, E port	JSY1000	JSY3000
C4	ø4 One-touch fitting	●	—
C6	ø6 One-touch fitting	—	●

Part numbers of mounting screw
(2 pcs. of each)

JSY1000: 25A-JSY11V-23-5A
JSY3000: 25A-JSY31V-23-5A

How to Order Pilot Valves

For 25A-JSY3000

25A-V111 **5** **L** **Z**

Coil type

Nil	Standard
T	With power-saving circuit (Made to Order)

Light/surge voltage suppressor

Z	With light/surge voltage suppressor
---	-------------------------------------

Electrical entry

Symbol	Electrical entry	Notes
L	L plug connector	With lead wire
LO	L plug connector	Without connector
M	M plug connector	With lead wire
MO	M plug connector	Without connector

Rated voltage

5	24 VDC
---	--------

* For the 25A-JSY1000, the pilot valve is the same as that of the standard model.

TROUBLE SHOOTING

Trouble		Possible cause	Countermeasures
Malfunction No air changeover.	<div style="border: 1px solid black; border-radius: 10px; padding: 5px; width: fit-content;"> The valve operates when the manual override button is pushed? </div> <p style="text-align: center;">No →</p> <p style="text-align: center;">Yes</p>	1) Operation failure or sticking of the main valve. ● Foreign matter from the piping and air source got caught in the main valve, causing a malfunction. ● Malfunction occurred due to sticking such as swelling of the rubber part of the main valve.	<ul style="list-style-type: none"> - Replace the valve. - Clean the air supply. - If incorrect oil has been used for lubrication, remove the oil by air blow. - If there is a large amount of condensate or condensate cannot be removed completely, mount an auto drain or install a dryer and replace the valve.
		2) Pressure drop Air source pressure is reduced and minimum operating pressure of the valve was not reached, causing an operation failure.	<ul style="list-style-type: none"> - Adjust the pressure within the specification range for the valve.
		3) Excessive oil supply Due to excessive lubrication, oil accumulated inside the valve, causing malfunction.	<ul style="list-style-type: none"> - Reduce the amount of lubrication to the amount at which the oil does not splash from the exhaust port [5/3 (EA/EB)].
	<div style="border: 1px solid black; border-radius: 10px; padding: 5px; width: fit-content;"> Energized? Is valve switched? </div> <p style="text-align: center;">No →</p> <p style="text-align: center;">Yes</p>	1) Non-conformance of electric system - Incorrect wiring - Fuse blown out, lead wire broken - Incorrect contact at the contact and connection - Sequencer non-conformance - Supply voltage insufficient	<ul style="list-style-type: none"> - Check all parts and replace the part, if necessary. - Check the supply voltage.
		2) Drop of supply voltage Operation failure of the valve due to voltage drop.	<ul style="list-style-type: none"> - Check the supply voltage. Take corrective action if voltage drop is confirmed.
		3) Non-conformance of the installed pilot valve - Broken wire in the coil or burnout (High supply voltage, incorrect coil specification, entry of water)	<ul style="list-style-type: none"> - Replace the valve. - Protect the valve especially the coil to prevent being exposed to water.
	<p style="text-align: center;">→</p>	1) Leakage current Operation failure of the valve occurred due to residual voltage. (Valve is not turned OFF)	<ul style="list-style-type: none"> - Check the residual voltage. - Keep the residual voltage at 3% of the rated voltage or less.
		2) Non-conformance of the installed pilot valve - Foreign matter is caught in the moving part of the valve (or pilot valve). - Swelling of rubber parts inside the valve (or pilot valve)	<ul style="list-style-type: none"> - Clean the air supply. - Eliminate foreign matter with air blow. - Replace the valve when actions above do not improve the condition.

Trouble	For valve non-conformance, take following countermeasures referring to trouble.	Possible causes	Countermeasures
Response failure Valve and actuator become slow.	The valve is slow. Actuators including cylinder become slow.	1) Leakage voltage When the valve is turned off, it became slow due to the leakage voltage.	-Check the leakage voltage. -Keep the leakage voltage at 3% of the rated voltage or less.
		2) Clogging of the filter and silencer Filter or silencer is clogged, or exhaust port [5/3 (EA/EB)] is blocked.	- Replace the filter. - Replace the silencer. - Do not block the valve exhaust port.
		3) Operation failure or sticking of the main valve. Foreign matter from the piping and air source got caught in the main valve of the valve, causing a delay. Malfunction occurred due to sticking such as swelling of the rubber part of the main valve.	- Replace the valve. - Check for abnormalities in devices other than valves. - Clean the air supply. - If incorrect oil has been used for lubrication, remove the oil by air blow. - If there is a large amount of condensate or condensate cannot be removed completely, mount an auto drain or install a dryer and replace the valve.
Air leakage	Find and check the air leakage point. 1. Leakage between valve and base. (Base mounted type) Leakage between body and PE plate. (Body ported type) 2. Air leakage from output [2(B),4(A)] port and exhaust [5 (EA),3(EB)] port. 3. Air leakage from the pilot valve air exhaust port (PE port). (External pilot type)	1) Valve mounting screw is loose	-Tighten the mounting screw. Proper tightening torque - M1.4 : 0.06N · m - M2 : 0.16N · m
		2) Damage or displacement of the gasket	- If gasket is scratched, replace the gasket.
		3) Foreign matter caught in the gasket seat	- Eliminate foreign matter with air blow. -If gasket is scratched, replace the gasket.
		1) Valve mounting screw is loose	-Tighten the mounting screw. Proper tightening torque - M1.4 : 0.06N · m - M2 : 0.16N · m - If gasket is scratched, replace the gasket.
		2) Internal air leakage increased because foreign matter get caught in the main valve.	- Replace the valve. - Clean the air supply.
		3) Sealing failure of the actuator (cylinder)	- Refer to the operation manual of the actuator for details.
		1) Foreign matter is caught in the pilot valve armature.	- Replace the valve. - Clean the air supply.

If the countermeasures above are not effective, there may be a trouble with the valve. Stop using the valve immediately.

If any of the examples below are applicable, there may be an internal trouble with the valve. Stop using the valve immediately.

- ① It was used with a voltage other than the rated voltage.
- ② The supplied oil was not the specified type.
- ③ Lubrication was stopped during operation. OR lubrication was interrupted temporarily.
- ④ Severe impact was applied.
- ⑤ Foreign matter such as condensate or dust has entered into the product.
- ⑥ Other than the cases mentioned above, any usage which falls under the precautions in this operation manual.

※ If the product has failed, then please return the valve without any modifications.

Revision history

A	RENEWAL	2022.2
B	Corrected notes on manual operation.	2024.5
C	Corrected notes and added fittings size.	2024.10

SMC Corporation

4-14-1, Sotokanda, Chiyoda-ku, Tokyo 101-0021 JAPAN

Tel: + 81 3 5207 8249 Fax: +81 3 5298 5362

URL <https://www.smcworld.com>

Note: Specifications are subject to change without prior notice and any obligation on the part of the manufacturer.

© 2022 SMC Corporation All Rights Reserved

No.JSY3000V-OMZ0004-C