

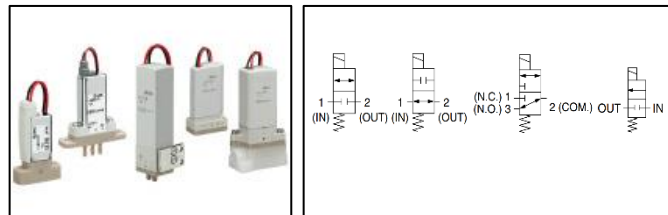

ORIGINAL INSTRUCTIONS

Instruction Manual

2/3 Port Solenoid valve for Chemical Liquids
LVM Series



The intended use of this product is for the control of the downstream fluid supply.

1 Safety Instructions

Be sure to read the "Handling Precautions for SMC Products", "Product Catalogue" and the "Operation Manual" on the SMC website before handling this product:

<https://www.smcworld.com/pl/en-ip> <https://www.smc.eu/en-eu/safety-instructions>

These safety instructions are intended to prevent hazardous situations and/or equipment damage. These instructions indicate the level of potential hazard with the labels of "Caution," "Warning" or "Danger." They are all important notes for safety and must be followed in addition to International Standards (ISO/IEC), and other safety regulations.

Danger	Danger indicates a hazard with a high level of risk which, if not avoided, will result in death or serious injury.
Warning	Warning indicates a hazard with a medium level of risk which, if not avoided, could result in death or serious injury.
Caution	Caution indicates a hazard with a low level of risk which, if not avoided, could result in minor or moderate injury.

Warning

- Always ensure compliance with relevant safety laws and standards.
- All work must be carried out in a safe manner by a qualified person in compliance with applicable national regulations.

Caution

- The product is provided for use in manufacturing industries only. This product must not be used in residential areas.

2 Specifications

2.1 General Specifications LVM07

Model	Base mounted	
	LVM07R6	
Valve Construction	Direct operated rocker Type	
Valve type	N.C.	
Number of ports	2	
Fluid ¹⁾	Air, Water, DI water, Diluent, Cleaning fluid	
Operating pressure range	-75 kPa to 0.1 MPa	
Orifice diameter	0.8 mm	
Response time ⁵⁾	10 ms or less	
Leakage	Zero leakage (at water pressure)	
Proof pressure ²⁾	0.15 MPa	
Ambient Temperature ⁶⁾	0 to 50°C	
Fluid Temperature ⁶⁾	0 to 50°C (No Freezing)	
Valve chamber volume ³⁾	8 µL	
Mounting orientation ⁴⁾	Free	

2 Specification - continued

Enclosure	IP40 or equivalent		
Weight	7 g		
Rated Voltage	12, 24 VDC		
Voltage fluctuation ⁷⁾	±10% of rated voltage		
Type of coil insulation	Class B		
Power Consumption (When rated voltage is 24V)	Standard ^{*)}		
	With power saving	Inrush	2.8 W (0.12 A)
		Holding	0.8 W
Coil switching noise ⁸⁾	50 dB		

Table 1

* The LVM07R6 (standard type) requires power saving control. Implement power saving control according to Figure 1

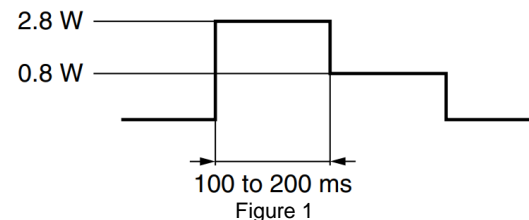

2.1 General Specifications LVM09/090

Model	Body Ported		
	LVM09R1	LVM09R2	
Valve construction	Direct operated rocker type		
Valve type	N.C.	N.O.	
Number of ports	2		
Fluid ¹⁾	Air, Water, DI water, Diluent, Cleaning fluid		
Operating pressure range	-75 kPa to 0.2 MPa		
Orifice diameter	1 mm		
Response time ⁵⁾	10 ms or less (air)		
Leakage	Zero leakage (at water pressure)		
Proof pressure ²⁾	0.3 MPa		
Ambient Temperature ⁶⁾	0 to 50°C		
Fluid Temperature ⁶⁾	0 to 50°C (No Freezing)		
Valve chamber volume ³⁾	18 µL		
Mounting orientation ⁴⁾	Free		
Enclosure	IP40 or equivalent		
Weight	22 g		
Rated Voltage	12, 24 VDC		
Voltage fluctuation ⁷⁾	±10% of rated voltage		
Type of coil insulation	Class B		
Power Consumption (When rated voltage is 24V)	Standard		
	Power Saving	Inrush	2 W (0.08 A)
		Holding	0.9 W
Coil switching noise ⁸⁾	50 dB		

Table 2

2 Specification - continued

Model	Base Mounted		
	LVM09R3	LVM09R4	LVM09R6
Valve construction	Direct operated rocker type		
Valve type	N.C.	N.O.	N.C.
Number of ports	2		
Fluid ¹⁾	Air, Water, DI water, Diluent, Cleaning fluid		
Operating pressure	-75 kPa to 0.2 MPa		
Orifice diameter	1.1 mm		
Response time ⁵⁾	10 ms or less (air)		
Leakage	Zero leakage (at water pressure)		
Proof pressure ²⁾	0.3 MPa		
Ambient Temperature ⁶⁾	0 to 50°C		
Fluid Temperature ⁶⁾	0 to 50°C (No Freezing)		
Valve chamber volume ³⁾	18 µL	29 µL	
Mounting orientation ⁴⁾	Free		
Enclosure	IP40 or equivalent		
Weight	20 g		
Rated Voltage	12, 24 VDC		
Voltage fluctuation ⁷⁾	±10% of rated voltage		
Type of coil insulation	Class B		
Power Consumption (When rated voltage is 24V)	Standard		
	Power Saving	Inrush	2 W (0.08 A)
		Holding	0.9 W
Coil switching noise ⁸⁾	50 dB		

Table 3

Model	Body ported	Base mounted	
	LVM092R	LVM095R	
Valve construction	Direct operated rocker type		
Valve type	Universal		
Number of ports	3		
Fluid ¹⁾	Air, Water, DI water, Diluent, Cleaning fluid		
Operating pressure	-75 kPa to 0.2 MPa		
Orifice diameter	1 mm	1.1 mm	
Response time ⁵⁾	10 ms or less (air)		
Leakage	Zero leakage (at water pressure)		
Proof pressure ²⁾	0.3 MPa		
Ambient Temperature ⁶⁾	0 to 50°C		
Fluid Temperature ⁶⁾	0 to 50°C (No Freezing)		
Valve chamber volume ³⁾	18 µL		
Mounting orientation ⁴⁾	Free		
Enclosure	IP40 or equivalent		
Weight	22 g	20 g	
Rated Voltage	12, 24 VDC		
Voltage fluctuation ⁷⁾	±10% of rated voltage		
Type of coil insulation	Class B		
Power Consumption (When rated voltage is 24V)	Standard		
	Power Saving	Inrush	2 W (0.08 A)
		Holding	0.9 W
Coil switching noise ⁸⁾	50 dB		

Table 4

2 Specification - continued

2.2 General Specifications LVM10/100

Model	Body Ported		
	LVM10R1	LVM10R2	
Valve construction	Direct operated rocker type		
Valve type	N.C.	N.O.	
Number of ports	2		
Fluid ¹⁾	Air, Water, DI water, Diluent, Cleaning fluid		
Operating pressure range	-75 kPa to 0.25 MPa		
Orifice diameter	1.4 mm		
Response time ⁵⁾	10 ms or less (air)		
Leakage	Zero leakage (at water pressure)		
Proof pressure ²⁾	0.38 MPa		
Ambient Temperature ⁶⁾	0 to 50°C		
Fluid Temperature ⁶⁾	0 to 50°C (No Freezing)		
Valve chamber volume ³⁾	20 µL		
Mounting orientation ⁴⁾	Free		
Enclosure	IP40 or equivalent		
Weight	34 g		
Rated Voltage	12, 24 VDC		
Voltage fluctuation ⁷⁾	±10% of rated voltage		
Type of coil insulation	Class B		
Power Consumption (When rated voltage is 24V)	Standard		
	Power Saving	Inrush	1.5 W (0.06 A)
		Holding	1 W
Coil switching noise ⁸⁾	50 dB		

Table 5

Model	Base mounted		
	LVM10R3	LVM10R4	LVM10R6
Valve construction	Direct operated rocker type		
Valve type	N.C.	N.O.	N.C.
Number of ports	2		
Fluid ¹⁾	Air, Water, DI water, Diluent, Cleaning fluid		
Operating pressure	-75 kPa to 0.25 MPa		
Orifice diameter	1.4 mm		
Response time ⁵⁾	10 ms or less (air)		
Leakage	Zero leakage (at water pressure)		
Proof pressure ²⁾	0.38 MPa		
Ambient Temperature ⁶⁾	0 to 50°C		
Fluid Temperature ⁶⁾	0 to 50°C (No Freezing)		
Valve chamber volume ³⁾	20 µL		
Mounting orientation ⁴⁾	Free		
Enclosure	IP40 or equivalent		
Weight	34 g (Without subplate) 42 g (With subplate)		
Rated Voltage	12, 24 VDC		
Voltage fluctuation ⁷⁾	±10% of rated voltage		
Type of coil insulation	Class B		
Power Consumption (When rated voltage is 24V)	Standard		
	Power Saving	Inrush	1.5 W (0.06A)
		Holding	1 W
Coil switching noise ⁸⁾	50 dB		

Table 6

2 Specification - continued

Model	Body ported		Base mounted	
	LVM102R		LVM105R	
Valve construction	Direct operated rocker type			
Valve type	Universal			
Number of ports	3			
Fluid ¹⁾	Air, Water, DI water, Diluent, Cleaning fluid			
Operating pressure	-75 kPa to 0.25 MPa			
Orifice diameter	1.4 mm			
Response time ⁵⁾	10 ms or less (air)			
Leakage	Zero leakage (at water pressure)			
Proof pressure ²⁾	0.38 MPa			
Ambient Temperature ⁶⁾	0 to 50°C			
Fluid Temperature ⁶⁾	0 to 50°C (No Freezing)			
Valve chamber volume ³⁾	20 µL			
Mounting orientation ⁴⁾	Free			
Enclosure	IP40 or equivalent			
Weight	34 g	34 g (Without subplate)		
		42 g (With subplate)		
Rated Voltage	12, 24 VDC			
Voltage fluctuation ⁷⁾	±10% of rated voltage			
Type of coil insulation	Class B			
Power Consumption (When rated voltage is 24V)	Standard	1.5 W (0.06 A)		
		2.5 W (0.1 A)		
	Power Saving	Inrush	2.5 W (0.1 A)	
		Holding	1 W	
Coil switching noise ⁸⁾	50 dB			

Table 7

2.3 General Specifications LVM11/13

Model	Body ported		Base mounted	
	LVM11		LVM13	
Valve construction	Direct operated poppet type			
Valve type	N.C.			
Number of ports	2			
Fluid ¹⁾	Air, Water, DI water, Diluent, Cleaning fluid			
Operating pressure	0 to 0.25 MPa			
Orifice diameter	1.5 mm			
Response time ⁵⁾	10 ms or less (air)			
Leakage	Zero leakage (at water pressure)			
Proof pressure ²⁾	0.38 MPa			
Ambient Temperature ⁶⁾	0 to 50°C			
Fluid Temperature ⁶⁾	0 to 50°C (No Freezing)			
Valve chamber volume ³⁾	11 µL	13 µL		
Mounting orientation ⁴⁾	Free			
Enclosure	IP40 or equivalent			
Weight	30 g			
Rated Voltage	12, 24 VDC			
Voltage fluctuation ⁷⁾	±10% of rated voltage			
Type of coil insulation	Class B			
Power Consumption (When rated voltage is 24V)	Power saving	2.5 W (0.1 A)		
		1 W		
	Inrush	2.5 W (0.1 A)		
		1 W		
Coil switching noise ⁸⁾	50 dB			

Table 8

2 Specification - continued

2.4 General Specifications LVM15/150

Model	Base mounted	
	LVM15R3	LVM15R4
Valve construction	Direct operated rocker type	
Valve type	N.C.	N.O.
Number of ports	2	
Fluid ¹⁾	Air, Water, DI water, Diluent, Cleaning fluid	
Operating pressure range	Standard	-75 kPa to 0.25 MPa
	High-pressure	Maximum 0.6 MPa [*]
Orifice diameter	Standard	1.6 mm
	High-pressure	1 mm
Response time ⁵⁾	15 ms or less (air)	
Leakage	Zero leakage (at water pressure)	
Proof pressure ²⁾	Standard	0.38 MPa
	High-pressure	0.9 MPa
Ambient Temperature ⁶⁾	0 to 50°C	
Fluid Temperature ⁶⁾	0 to 50°C (No Freezing)	
Valve chamber volume ³⁾	50 µL	
Mounting orientation ⁴⁾	Free	
Enclosure	IP40 or equivalent	
Weight	45 g (Without Subplate) 56 g (With subplate)	
Rated Voltage	12, 24 VDC	
Voltage fluctuation ⁷⁾	±10% of rated voltage	
Type of coil insulation	Class B	
Power Consumption (When rated voltage is 24V)	Inrush	5.5 W (0.23 A)
		1 W
	Holding	1 W
Coil switching noise ⁸⁾	60 dB	

Table 9

* The high-pressure type can also be used at -75 kPa. However, 0.6 MPa is the maximum pressure differential.

Model	Base mounted	
	LVM15R6	LVM155R
Valve construction	Direct operated rocker type	
Valve type	N.C.	Universal
Number of ports	2	3
Fluid ¹⁾	Air, Water, DI water, Diluent, Cleaning fluid	
Operating pressure range	Standard	-75 kPa to 0.25 MPa
	High-pressure	Maximum 0.6 MPa [*]
Orifice diameter	Standard	1.6 mm
	High-pressure	1 mm
Response time ⁵⁾	15 ms or less (air)	
Leakage	Zero leakage (at water pressure)	
Proof pressure ²⁾	Standard	0.38 MPa
	High-pressure	0.9 MPa
Ambient Temperature ⁶⁾	0 to 50°C	
Fluid Temperature ⁶⁾	0 to 50°C (No Freezing)	
Valve chamber volume ³⁾	60 µL	50 µL
Mounting orientation ⁴⁾	Free	
Enclosure	IP40 or equivalent	
Weight	45 g (Without Subplate) 56 g (With subplate)	
Rated Voltage	12, 24 VDC	
Voltage fluctuation ⁷⁾	±10% of rated voltage	
Type of coil insulation	Class B	
Power Consumption (When rated voltage is 24V)	Inrush	5.5 W (0.23 A)
		1 W
	Holding	1 W
Coil switching noise ⁸⁾	60 dB	

Table 10

* The high-pressure type can also be used at -75 kPa. However, 0.6 MPa is the maximum pressure differential.

2 Specification - continued

2.5 General Specifications LVM20/200

Model	Body ported			
	LVM20R1	LVM20R2	LVM20R2R	
Valve construction	Direct operated rocker type			
Valve type	N.C.	N.O.	Universal	
Number of ports	2		3	
Fluid ¹⁾	Air, Water, DI water, Diluent, Cleaning fluid			
Operating pressure range	-75 kPa to 0.25 MPa			
Orifice diameter	2 mm			
Response time ⁵⁾	20 ms or less (air)			
Leakage	Zero leakage (at water pressure)			
Proof pressure ²⁾	0.38 MPa			
Ambient Temperature ⁶⁾	0 to 50°C			
Fluid Temperature ⁶⁾	0 to 50°C (No Freezing)			
Valve chamber volume ³⁾	84 µL			
Mounting orientation ⁴⁾	Free			
Enclosure	IP40 or equivalent			
Weight	80g			
Rated voltage	12, 24 VDC			
Allowable voltage fluctuation ⁷⁾	±10% of rated voltage			
Type of Coil insulation	Class B			
Power Consumption (When rated voltage is 24V)	Standard	2.5 W (0.1 A)		
		4 W (0.17 A)		
	Power Saving	Inrush	4 W (0.17 A)	
		Holding	0.6 W	
Coil switching noise ⁸⁾	60 dB			

Table 11

Model	Base mounted			
	LVM20R3	LVM20R4	LVM205R	
Valve type	N.C.	N.O.	Universal	
Number of ports	2		3	
Fluid ¹⁾	Air, Water, DI water, Diluent, Cleaning fluid			
Operating pressure range	-75 kPa to 0.3 MPa			
Orifice diameter	2 mm			
Response time ⁵⁾	20 ms or less (air)			
Leakage	Zero leakage (at water pressure)			
Proof pressure ²⁾	0.45 MPa			
Ambient Temperature ⁶⁾	0 to 50°C			
Fluid Temperature ⁶⁾	0 to 50°C (No Freezing)			
Valve chamber volume ³⁾	84 µL			
Mounting orientation ⁴⁾	Free			
Enclosure	IP40 or equivalent			
Weight	80 g (Without subplate) 94 g (With subplate)			
Rated voltage	12, 24 VDC			
Allowable voltage fluctuation	±10% of rated voltage			
Type of coil insulation	Class B			
Power Consumption (When rated voltage is 24V)	Standard	2.5 W (0.1 A)		
		4 W (0.17 A)		
	Power Saving	Inrush	4 W (0.17 A)	
		Holding	0.6 W	
Coil switching noise ⁸⁾	60 dB			

Table 12

2 Specification - continued

2.6 General Specifications LVM30

Model	Body ported		Base mounted	
	LVM31		LVM33	
Valve construction	Direct operated poppet type			
Valve type	N.C.			
Number of ports	2			
Fluid ¹⁾	Air, Water, DI water, Diluent, Cleaning fluid			
Operating pressure range ⁹⁾	IN -> OUT: -90 kPa to 0.2 MPa OUT -> IN: 0 to 0.1 MPa			
Orifice diameter	5 mm			
Response time ⁵⁾	30 ms or less (air)			
Leakage	Zero leakage (at water pressure)			
Proof pressure ²⁾	0.3 MPa			
Ambient Temperature	0 to 50°C			
Fluid Temperature	0 to 50°C (No Freezing)			
Valve chamber volume ³⁾	500 µL	600 µL		
Mounting orientation ⁴⁾	Free			
Enclosure	IP40 or equivalent			
Weight	210g	200g		
Rated voltage	12, 24 VDC			
Allowable voltage fluctuation ⁷⁾	±10% of rated voltage			
Type of Coil insulation	Class B			
Power Consumption (When rated voltage is 24V)	Power Saving	Inrush	7.5 W (0.31 A)	
			2 W	
	Holding	2 W		
Coil switching noise ⁸⁾	80 dB			

Table 13

Notes:

- Select an appropriate fluid contact material according to the fluid to be used. Additionally, check the chemical resistance beforehand.
- Indicates the pressure which does not generate breakage or cracks after a one-minute airtight test
- Indicates the volume inside the valve chamber after the volume of the diaphragm is subtracted.
- When residual liquid needs to be taken into consideration, mounting in a vertical direction with the coil at the top is recommended. When residual liquid need not be taken into consideration, any mounting orientation is available.
- In compliance with JIS B 8419:2010 (Value at ambient and fluid temperatures of 25°C, rated voltage, max. operating pressure (air), and when the N.C. (IN) port is pressurized) The response time will vary depending on the supply pressure, fluid, piping conditions, and ambient temperature.
- When the diaphragm material is Kalrez®, the valve response time will be significantly longer at ambient and fluid temperatures of 15°C or less when compared to the valve response time at room temperature (≈ 25°C).
- When response time is prioritized, control the voltage so that there is no fluctuation below the rated voltage.
- The value is based on SMC's measurement conditions. The noise level will vary according to the actual conditions.
- When using IN → OUT, the pressure (back pressure) on the OUT side should be 0.1 MPa or less.

2 Specifications - continued

2.7 Flow characteristics

Model	Flow Characteristics			
	Water		Air	
	Kv	Cv	C	b
LVM07	0.004	0.005	0.02	0.2
LVM09	0.015	0.018	0.06	0.2
LVM10	0.025	0.03	0.1	0.2
LVM11/13	0.034	0.04	0.13	0.22
LVM15 [*]	0.034 [0.012]	0.04 [0.015]	0.13 [0.05]	0.22 [0.2]
LVM20	0.055	0.065	0.23	0.27
LVM31/33	0.36	0.42	1.64	0.23

* The [] indicates the values of the high-pressure type.

Warning

Special products might have specifications different from those shown in this section. Contact SMC for specific drawings.

3 Installation

3.1 Installation

Warning

- Do not install the product unless the safety instructions have been read and understood.

3.1.1 LVM07 Mounting interface

Recommended interface dimensions (mm)

When using a positioning pin for mounting please use $\phi 1.5$ mm and a height 2 mm or less
For option P, the size should be $\phi 1.5$ mm and the depth should be 2.3 mm or more

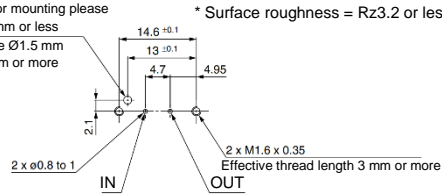
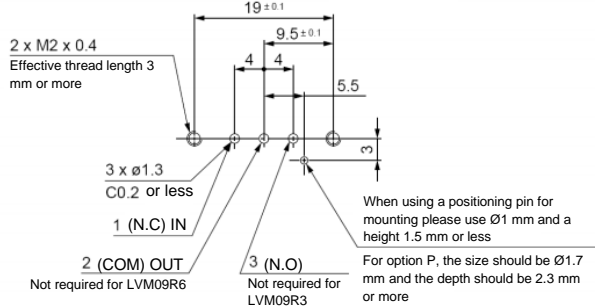

Figure 2

3.1.2 LVM09/090 Mounting interface

Recommended interface dimensions (mm)

* Surface roughness = $Rz3.2$ or less



LVM09R3, LVM095R, LVM09R6

* Surface roughness = $Rz3.2$ or less

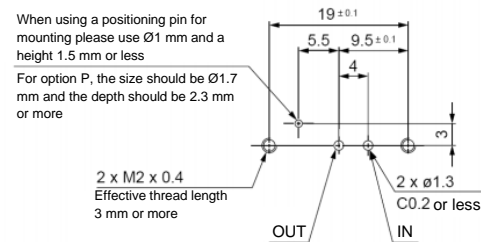

LVM09R4

Figure 3

3 Installation - continued

3.1.3 LVM10/100 Mounting interface

Recommended interface dimensions (mm)

* Surface roughness = $Rz3.2$ or less

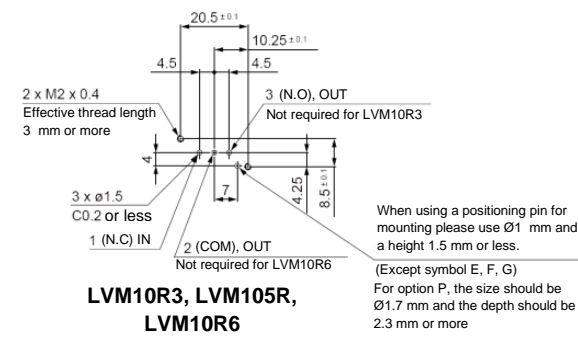

LVM10R3, LVM105R, LVM10R6

* Surface roughness = $Rz3.2$ or less

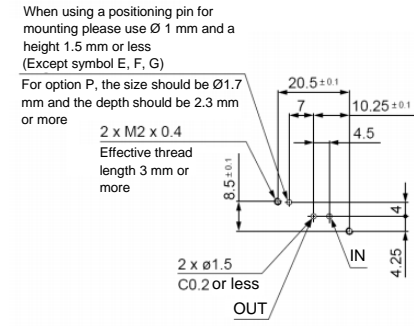

LVM10R4

Figure 4

3.1.4 LVM15/150 Mounting interface

Recommended interface dimensions (mm)

* Surface roughness = $Rz3.2$ or less

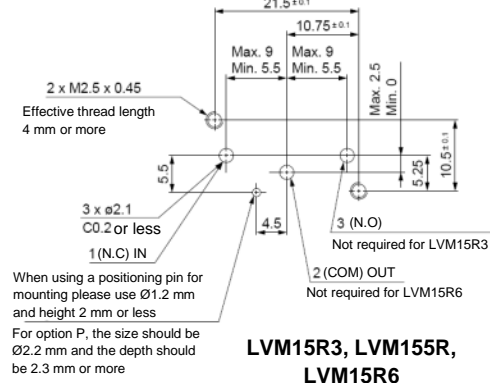

LVM15R3, LVM155R, LVM15R6

* Surface roughness = $Rz3.2$ or less

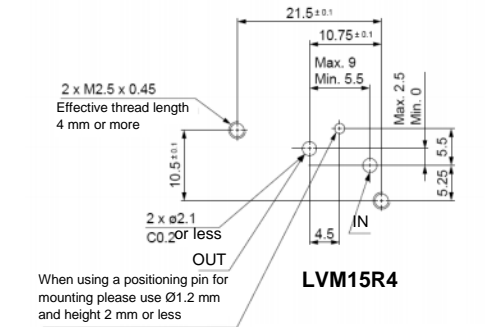

LVM15R4

Figure 5

3 Installation - continued

3.1.5 LVM20/200 Mounting interface

Recommended interface dimensions (mm)

* Surface roughness = $Rz3.2$ or less

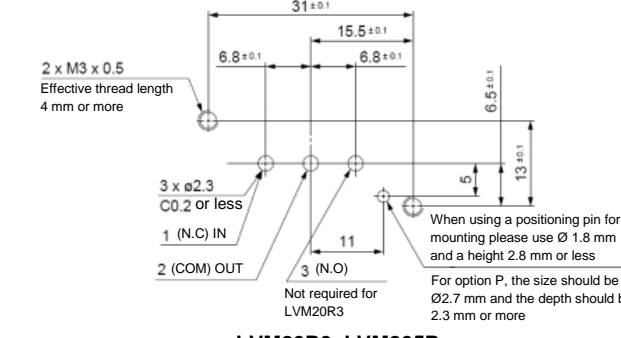

LVM20R3, LVM205R,

* Surface roughness = $Rz3.2$ or less

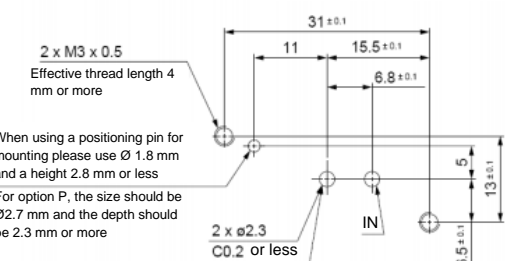

LVM20R4

Figure 6

3.1.6 LVM13 Mounting interface

Recommended interface dimensions (mm)

* Surface roughness = $Rz3.2$ or less

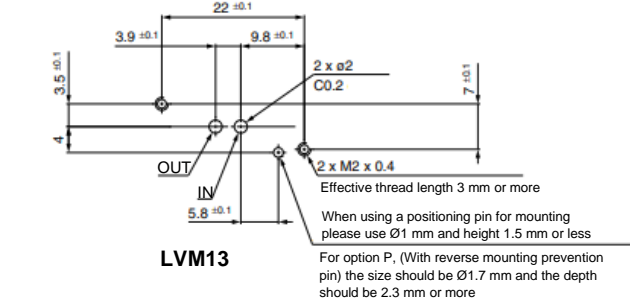

LVM13

Figure 7

3.1.7 LVM33 Mounting interface

Recommended interface dimensions (mm)

* Surface roughness = $Rz3.2$ or less

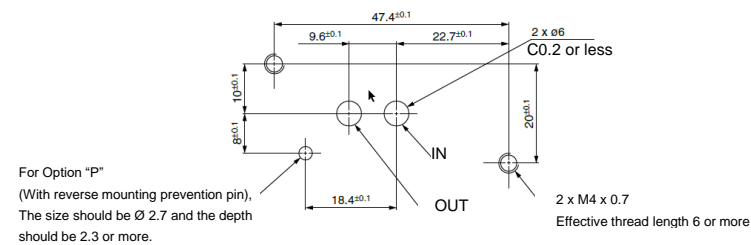

LVM33

Figure 8

3 Installation - continued

3.2 Environment

Warning

- Do not use in an environment where corrosive gases, chemicals, salt water or steam are present.
- Do not use in an explosive atmosphere.
- Do not expose to direct sunlight. Use a suitable protective cover.
- Do not mount in a location exposed to radiant heat that would result in temperatures exceeding the product's specifications.
- Do not install in a location subject to vibration or impact exceeding the product's specifications.

Impact resistance of the solenoid valve is 150 m/s². Vibration resistance of this solenoid is 30 m/s².

3.3 Piping

Caution

- Before piping is connected, it should be thoroughly blown out with air (flushing) or washed to remove chips, cutting oil, and other debris from inside the pipe.
- When installing piping or fittings, ensure sealant material does not enter inside the port. When using seal tape, leave sufficient space at the end of the thread to ensure that sealing tape does not enter the product.
- Preparation before piping**
Before piping is connected, it should be thoroughly blown out with air (flushing) or washed to remove chips, cutting oil, and other debris from inside the pipe.
- When tubing is connected to the body-ported solenoid valve, insert the tubing straight to the end of the tube inlet for a complete fit.**

Model	Tube inside diameter (I.D.)	Tube outside diameter (O.D.) (after mounting)
LVM09R1, 09R2, 09R2R	$\phi 1.9$ or less	$\phi 4.2$ or less
LVM10R1, 10R2, 10R2R	$\phi 2.5$ or less	$\phi 4.5$ or less
LVM20R1, 20R2, 20R2R	$\phi 3.1$ or less	$\phi 6.8$ or less

Table 14

The holding force varies by the tubing material. Be sure to confirm the holding force of each material before operation. After connecting the tubing, care should be taken not to put excessive force (tensile force, compression, bending, etc.) on the tubing. If an external force of 20 N or more is applied to the tube inlet, the inlet may become damaged, and leakage or breakage could occur.

- When the tubing is long or depending on the operating conditions, tubing may thrash about causing damage to the tube inlet of the solenoid valve, or the tubing to come off or deteriorate. In this case, secure the tubing to prevent its uncontrolled movement.
- When piping the fitting to the solenoid valve, the installation method and tightening torque value may vary depending on the seal structure (shape) or material of the fitting to be used. Check the methods and precautions recommended by the fitting manufacturer to be used and be sure to check for leakage.

3 Installation - continued

The table below shows the tightening method using KQ2 series

Model	Location	Thread size	Tightening method	Tightening torque [N.m]
LVM11	Body	M5	After tightening by hand, tighten 1/6 to 1/4 turn with a tightening tool.	PEEK: 0.5 to 0.7
LVM07R6, LVM09R3, 09R4, 09R6, 095R	Base mounted (With subplate)	M6 or 1/4-28UNF	After tightening by hand, tighten 1/6 to 1/4 turn with a tightening tool.	PEEK: 0.5 to 0.6
LVM10R3, 10R4, 10R6, 105R		M6 or 1/4-28UNF	After tightening by hand, tighten 1/6 to 1/4 turn with a tightening tool.	PVDF: 0.6 to 0.8 PFA: 0.2 to 0.25
LVM15R3, 15R4, 15R6, 155R		M6 or 1/4-28UNF	After tightening by hand, tighten 1/6 to 1/4 turn with a tightening tool.	PVDF: 0.6 to 0.8
LVM20R3, 20R4, 205R		Rc1/8 or NPT1/8	Tighten approximately 4 turns.	PVDF: 0.5 to 0.6
LVM31	Body	G1/8	After tightening by hand, tighten 1/4 to 5/12 turn with a tightening tool.	PEEK: 2.5 to 3.5
		G1/4	After tightening by hand, tighten 2 to 3 turn with a tightening tool.	PEEK: 6 to 8
NPT1/8		After tightening by hand, tighten 2 to 3 turn with a tightening tool.	PEEK: 1 to 3	
NPT1/4		After tightening by hand, tighten 2 to 3 turn with a tightening tool.	PEEK: 1.5 to 3.5	

Table 15

3.4 Mounting

Caution

- Always tighten threads with the proper tightening torque.

When mounting the solenoid valve, tighten it with the proper tightening torque shown below.

Location	Model	Thread size	Tightening Torque [N.m]
Base Mounting,	LVM07R6	M1.6	0.06 to 0.1
	LVM09R3, 09R4, 09R6, 095R	M2	0.1 to 0.14
	LVM13	M2	0.15 to 0.2
Body Mounting	LVM10R3, 10R4, 10R6, 105R	M2	0.15 to 0.2
	LVM15R3, 15R4, 15R6, 155R	M2.5	0.25 to 0.35
	LVM20R3, 20R4, 205R	M3	0.4 to 0.6
	LVM33	M4	0.7 to 0.9
Body ported Body bottom surface (see figure 9)	LVM31	M5	0.5 to 0.7

Table 16

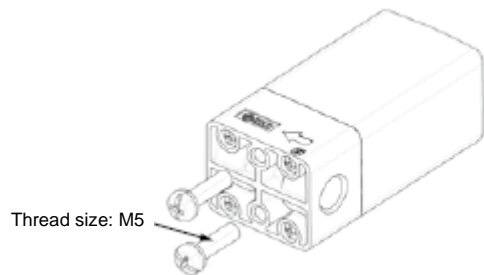

Figure 9

- Mount the solenoid valve on the horizontal surface.

3 Installation - continued

- Remove dust from the solenoid valve mounting surface completely. The surface roughness of the mounting surface should be Rz3.2 or less.
- When mounting the solenoid valves next to each other, the valve pitch should be the value or more shown in the table below.

Model	LVM07	LVM09/090	LVM13	LVM10/100	LVM15/150	LVM20/200	LVM33
Pitch	8	10.5	14	14	17	21	31

Table 17

Warning

- If air leakage increases or equipment does not operate properly, stop operation. After mounting, perform suitable function and leak tests to confirm that the mounting is correct.
- Since the body (orifice shape) is designed to eliminate residual liquid, mounting in a vertical direction with the coil at the top is recommended. When residual liquid need not be taken into consideration, any mounting orientation is available.

3.5 Electrical Connection

Caution

- Valves with power-saving circuits, LVM####(Y/Y1/HY), have polarity. Ensure correct electrical connections are made, see Figure 10.

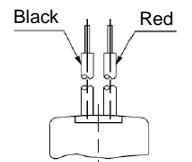

Lead wire colour
Red (+), Black (-)

Figure 10

- Avoid mis-wiring, as this can cause malfunction, damage and fire to the product.
- To prevent noise and surge in signal lines, keep all wiring separate from power lines and high voltage lines. Otherwise this can cause malfunction.
- When a surge from the solenoid affects the electrical circuitry, install a surge absorber, etc., in parallel with the solenoid. Or, adopt an option that comes with the surge voltage protection circuit.
- Use electrical circuits that do not generate chattering in their contacts.
- Use voltage that is within ±10% of the rated voltage. In cases with a DC power supply where responsiveness is important, control the voltage so that there is no fluctuation below the rated voltage.
- Generally use electrical wire with cross sectional area 0.5 to 1.25 mm².
- Do not bend or pull cables repeatedly.
- Connect the wires so that an external force greater than 10 N is not applied to the lead wire, otherwise the coil will burn.

3.6 How to use plug connectors

Caution

- Attaching Connectors**
Hold the lever and connector unit between your fingers and insert straight onto the pins of the solenoid valve so that the lever's pawl is pushed into the groove and locks.
- Detaching connectors**
Remove the pawl from the groove by pushing the lever downward with your thumb and pull the connector straight out.

3 Installation - continued

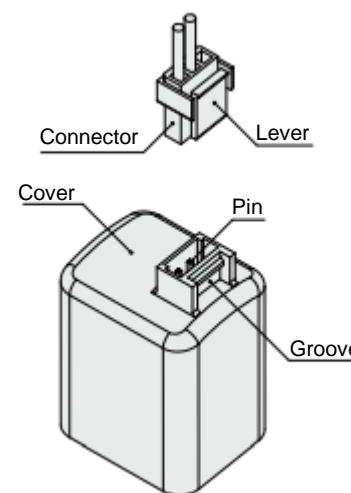

Figure 11

3.7 Valves with a power saving circuit (PWM built-in type)

Caution

- Valves with a power saving circuit (PWM circuit built-in type) perform the high-speed switching operation with the PWM control circuit inside the valve after the rated power has been applied for several tens of ms to reduce the power consumption. The problems shown below may occur in this type of valve due to the switch or drive circuit system used for the PWM control. Be sure to check the operation with the customer's machine sufficiently when selecting the product.

- If valve does not turn ON
 - If the PWM circuit built-in type valve is driven by a mechanical relay, etc., and chattering occurs during the several tens of ms necessary for the valve to reach its rated voltage, the valve may not turn ON correctly.
 - If a filter, etc., is connected between the power supply and the PWM circuit built-in type valve, the current necessary to drive the valve lowers due to the effects of the filter, and then the valve may not turn ON correctly.
- If Valve does not turn OFF
 - If the PWM circuit built-in type valve is driven by the photo coupler, the photo coupler cannot turn OFF and the valve is kept in an ON state. Therefore, take great care when using the photo coupler built-in SSR (solid state relay) or drive circuit.

4 Settings

4.1 Manual Override

Caution

- Ensure conditions are safe, since connected equipment will operate when manual override is performed.

Non-locking push type

- Push on the manual override button using a small-bladed screwdriver or a suitable tool until it stops ON.
- Hold this position for the duration of the check (ON position)
- Release the button and the override will re-set to OFF position.

4 Settings - continued

LVM10/100 Manual override position

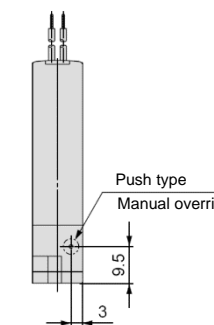

Figure 12

5 How to Order

Refer to drawings or catalogue for 'How to Order'.

6 Outline Dimensions (mm)

Refer to drawings or catalogue for outline dimensions.

7 Maintenance

7.1 General Maintenance

Caution

- Not following proper maintenance procedures could cause the product to malfunction and lead to equipment damage.
- If handled improperly, compressed air can be dangerous.
- Maintenance of pneumatic systems should be performed only by qualified personnel.
- Before performing maintenance, turn off the power supply and be sure to cut off the supply pressure. Confirm that the air is released to atmosphere.
- After installation and maintenance, apply operating pressure and power to the equipment, and perform appropriate functional and leakage tests to ensure the equipment is installed correctly.

- If any electrical connections are disturbed during maintenance, ensure they are reconnected correctly and that safety checks are carried out as required to maintain compliance with applicable national regulations.
- Do not make any modification to the product.
- Do not disassemble the product, unless required by installation or maintenance instructions.
- Before operating remove residual chemicals and completely replace with pure water, air etc.
- The installation should allow sufficient space for maintenance activities.

8 Limitations of Use

8.1 Limited warranty and Disclaimer/Compliance Requirements

Refer to Handling Precautions for SMC Products.

Warning

Fluid properties

- Be sure to confirm the compatibility between the component material and fluid.
- Liquid (Chemicals)**
Chemical fluids could crystallize or clot depending on its nature. Leakage will occur if a crystallized or clotted fluid is caught between the sealing parts. Take measures to clean such component if necessary.
- Water
Install a filter strainer of about 100 mesh on the inlet side of the piping.
- Air
Compressed air filtered with a filter with filtration rating of 5 µm or less, which is mounted on the inlet side of the piping, should be used.
- Confirm the specifications**
Do not exceed any of the specifications in section 2 of this document or the specific product catalogue.
- Fluid pressure range**
Fluid pressure should be within the allowable pressure range.

8 Limitations of Use - continued

- **Ambient environment**

Use within the allowable ambient temperature range.
Ensure the fluid does not touch the external surface of the product.

- **Low temperature environments**

When valve's diaphragm material is Kalrez® be aware that the valve changeover time becomes extremely long when the ambient and fluid temperature becomes 15°C or less as a reference when compared to the valve changeover time at room temperature (approx. 25°C).

- **Countermeasures against static electricity**

Take measures to prevent static electricity since some fluids can cause static electricity

- **Pressure (including vacuum) holding**

This product is not suitable for an application such as holding the pressure (including vacuum) inside a pressure vessel, because the valve has allowable leakage.

- **Cannot be used as an emergency shut-off valve etc.**

This product is not designed for safety applications such as an emergency shut-off valve. If the valves are used in this type of system, other reliable safety assurance measures should also be adopted.

- **Extended periods of continuous energization**

If solenoid valves are to be continuously energized for extended periods of time, use valves with power-saving circuit to minimise the amount of heat radiated by the coil.

Power-saving circuit waveform (Shown in Figure 13)

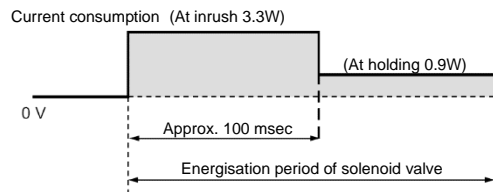

Figure 13

When a solenoid valve without a power-saving circuit is continuously energized for long periods of time its life and performance can deteriorate due to heat generated by the coil. The heat generated can also affect sensitive devices nearby. If continuous energisation is necessary, install a fan or take other measures to ensure valve surface temperature is kept below 70°C.

Table 18 shows reference values for continuously energized valve.

Series	LVM09/090	LVM10/100	LVM20/200
Period of continuous energisation	5 min. or less	30 min. or less	30 min. or less
Duty ratio	50% or less		
Ambient temperature	25°C or less		
Power-saving circuit	None		

Table 18

Duty ratio: ON time/(ON time + OFF time).

For the LVM15/150, power-saving circuit is standard.

Please use a fan or take other measures to disperse heat and keep temperatures within the specified range when mounting the solenoid valves inside control panels.

Be especially careful when using three or more adjacent valves with manifolds and keeping them continuously energized for extended periods, as this may result in dramatic increases in temperature.

⚠ Caution

8.2 EMC restrictions

8.2.1 Class and group description

- This product is group 1, class A equipment according to EN55011.
- Group 1 equipment does not intentionally generate radio-frequency energy in the range 9kHz to 400 GHz.

8 Limitations of Use - continued

- Class A equipment is equipment suitable for use in all locations other than those allocated in residential environments and those directly connected to a low voltage power supply network which supplies buildings used for domestic purposes.
- This equipment is not intended for use in residential environments and may not provide adequate protection to radio reception in such environments.

9 Product disposal

This product shall not be disposed of as municipal waste. Check your local regulations and guidelines to dispose of this product correctly, in order to reduce the impact on human health and the environment.

10 Return of Product

If the product to be returned is contaminated or is possibly contaminated with substances that are harmful to humans, for safety reasons, please contact SMC beforehand and then employ a specialist cleaning company to decontaminate the product. After the decontamination prescribed above has been carried out, submit a Product Return Request Sheet or the Detoxification/Decontamination Certificate to SMC and await SMC's approval and further instructions before attempting to return the item. Please refer to the International Chemical Safety Cards (ICSC) for a list of harmful substances.

11 Support / Importer / Manufacturer

Support: Please contact your distributor or importer in the country of purchase if you need assistance.

Importer: Address of importer in the country of purchase is listed at <https://www.smc.eu/en-eu/worldwide-addresses>

Manufacturer:

SMC Corporation

URL: <https://www.smcworld.com> (Global) <https://www.smc.eu> (Europe)
SMC Corporation, 1-5-5, Kyobashi, Chuo-ku, Tokyo 104-0031, Japan
Specifications are subject to change without prior notice from the manufacturer.
© SMC Corporation All Rights Reserved.
Template DKP50047-F-085J