

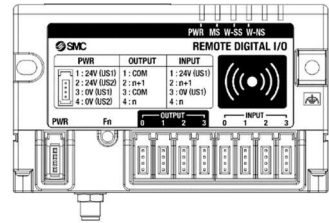

## Instruction Manual

**SMC Wireless System - Compact Remote  
Series EXW1-RDX# / -RDY# / -RDM#**

The intended use of this product is to provide a connection from the SMC wireless communication system to pneumatic devices.

### 1 Safety Instructions

These safety instructions are intended to prevent hazardous situations and/or equipment damage. These instructions indicate the level of potential hazard with the labels of "Caution," "Warning" or "Danger." They are all important notes for safety and must be followed in addition to International Standards (ISO/IEC)<sup>1)</sup>, and other safety regulations.

<sup>1)</sup>ISO 4414: Pneumatic fluid power — General rules and safety requirements for systems and their components.

ISO 4413: Hydraulic fluid power — General rules and safety requirements for systems and their components

IEC 60204-1: Safety of machinery - Electrical equipment of machines. Part 1: General requirements

ISO 10218-1: Robots and robotic devices - Safety requirements for industrial robots - Part 1: Robots

- Keep this manual in a safe place for future reference.
- Refer to the product catalogue, Operation Manual and Handling Precautions for SMC Products for additional information.

	<b>Danger</b> indicates a hazard with a high level of risk which, if not avoided, will result in death or serious injury.
	<b>Warning</b> indicates a hazard with a medium level of risk which, if not avoided, could result in death or serious injury.
	<b>Caution</b> indicates a hazard with a low level of risk which, if not avoided, could result in minor or moderate injury.

#### Warning

- **Always ensure compliance with relevant safety laws and standards.**  
All work must be carried out in a safe manner by a qualified person in compliance with applicable national regulations.

### 2 Specifications

#### 2.1 General specifications

Item	Specification
Enclosure rating	IP20
Ambient operating temperature	-10 to +50°C
Ambient storage temperature	-20 to +60°C
Ambient humidity	35 to 85% RH (no condensation)
Withstand voltage	500 VAC for 1 minute between external terminals (including the FE terminal) and enclosure screws
Insulation resistance	10 MΩ or more (500 VDC between external terminals (including the FE terminal) and enclosure screws)
Vibration resistance	EN61131-2 compliant: 5 ≤ f < 8.4 Hz 3.5 mm 8.4 ≤ f < 150 Hz 9.8 m/s <sup>2</sup>
Impact resistance	EN61131-2 compliant: 147 m/s <sup>2</sup> , 11 ms
Weight	130 g

### 2 Specifications (continued)

#### 2.2 Electrical specifications – EXW1-RDX# Input unit

Item	EXW1-RDXP#	EXW1-RDXN#	
US1 (for control / input) power supply voltage	24 VDC ±10%		
Current consumption	100 mA or less		
Inputs	Number of points	16 points (2 points / connector)	
	Output type	PNP      NPN	
	Connector type	e-CON (4 pins)	
	Max. supply current for sensor	0.3 A / connector, 2 A/unit	
	ON current	0.5 mA Typ.	
	OFF current	2 mA or less	
	ON voltage	11 V or more	
	OFF voltage	5 V or less	
	Short circuit protection	Included	

#### 2.3 Electrical specifications – EXW1-RDY# Output unit

Item	EXW1-RDYP#	EXW1-RDYN#	
US1 (for control / input) power supply voltage	24 VDC ±10%		
US2 (for output) power voltage	24 VDC ±10%		
Current consumption (US1)	100 mA or less		
Outputs	Number of points	16 points (2 points / connector)	
	Output type	PNP      NPN	
	Connector type	e-CON (4 pins)	
	Maximum load current	0.3 A / point, 2 A / unit	
	Short circuit protection	Included	

#### 2.4 Electrical specifications – EXW1-RDM# Input / Output unit

Item	EXW1-RDMP#	EXW1-RDMN#	
US1 (for control / input) power voltage drop	24 VDC ±10%		
US2 (for output) power voltage)	24 VDC ±10%		
Current consumption (US1)	100 mA or less		
Inputs	Number of points	8 points (2 points / connector)	
	Output type	PNP      NPN	
	Connector type	e-CON (4 pins)	
	Max. supply current for sensor	0.3 A / connector, 1 A / unit	
	ON current	0.5 mA Typ.	
	OFF current	2 mA or less	
	ON voltage	11 V or more	
	OFF voltage	5 V or less	
	Short circuit protection	Included	
Outputs	Number of points	8 points (2 points / connector)	
	Output type	PNP      NPN	
	Connector type	e-CON (4 pins)	
	Maximum load current	0.3 A / point, 2 A / unit	
Short circuit protection	Included		

### 2 Specifications (continued)

#### 2.5 Wireless Communication specifications

Item	Specifications
Protocol	SMC original protocol (SMC encryption)
Radio wave type (spread)	Frequency Hopping Spread Spectrum (FHSS)
Frequency band	2.4 GHz (2403 to 2481 MHz)
Frequency channel select function (F.C.S.)	Supported <sup>*1</sup>
Frequency channels	79 ch max. (Bandwidth: 1.0 MHz)
Communication speed	1 Mbps / 250 kbps <sup>*2</sup>
Communication distance	Up to 100 m line of sight (depending on the environment)
Radio Law certificates	Refer to the operation manual on the SMC website

\*1: The number of selectable frequency channels varies depending on the product number.

\*2: Select a protocol before performing pairing (V.2.0: 1 Mbps, V.1.0: 250 kbps). Different communication speeds are mutually incompatible.

#### 2.6 NFC Communication specifications

Item	Specifications
Communication standard	ISO / IEC14443B (Type-B)
Frequency	13.56 MHz
Communication speed	20 to 100 kHz (I2C)
Communication distance	Up to 1 cm

\* NFC component is a 13.56 MHz passive-type RFID tag.

### 3 Name and Function of parts (continued)

- Compact Remote Input / Output unit (EXW1-RDM#)

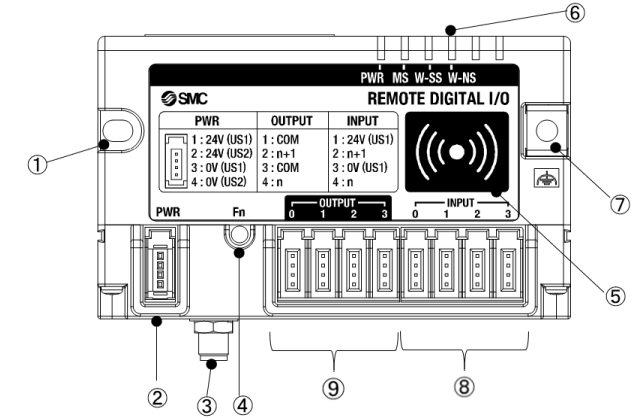

No.	Item	Description
1	Mounting holes	Mounting holes for compact wireless base (2 x M4).
2	PWR (Power connector)	Supplies power to the compact wireless Remote.
3	RF connector	SMA coaxial connector for external antenna (external antenna versions only).
4	Fn (Pairing button)	Press the button to select pairing mode.
5	NFC antenna area	Area in close contact with the NFC reader / writer ("o" marks the centre).
6	LED display	Indicates the status of the compact wireless Remote.
7	FE terminal and mounting hole (M4)	To be connected to Ground (for improved noise immunity).
8	Connector for Inputs	Connector for an input device. (PIN2, PIN4: input).
9	Connector for Outputs	Connector for an output device. (PIN2, PIN4: output).

### 3 Name and Function of parts

- Compact Remote Input unit (EXW1-RDX#)

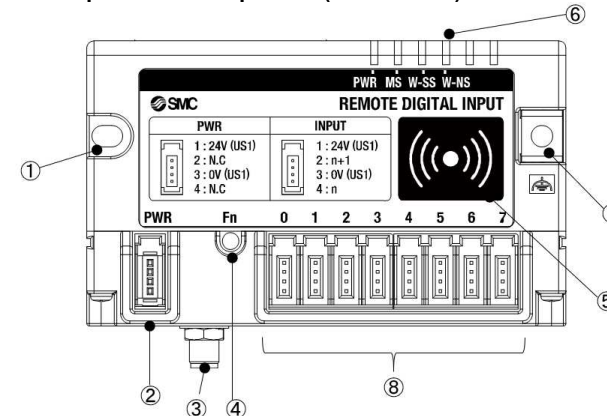

- Compact Remote Output unit (EXW1-RDY#)

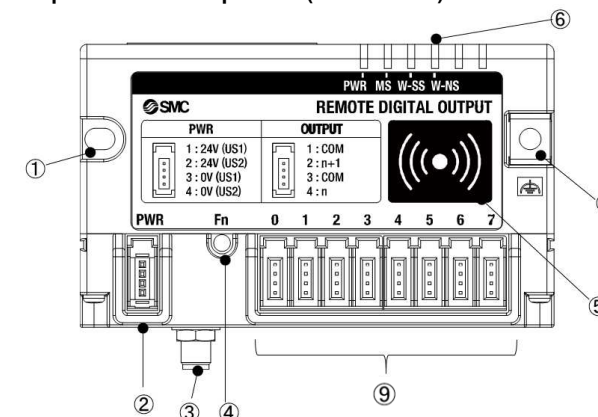

- Ground connection

The Ground connection to the FE terminal (M4 mounting hole) should be as close as possible to the product and the grounding wire should be as short as possible.

### 4 Installation

#### 4.1 Installation

#### Warning

- Do not install the product unless the safety instructions have been read and understood.

#### 4.2 Mounting

Mount the unit with M4 screws (not supplied) using the 2 mounting holes in the unit (Recommended torque: 0.8 ±10% N·m).

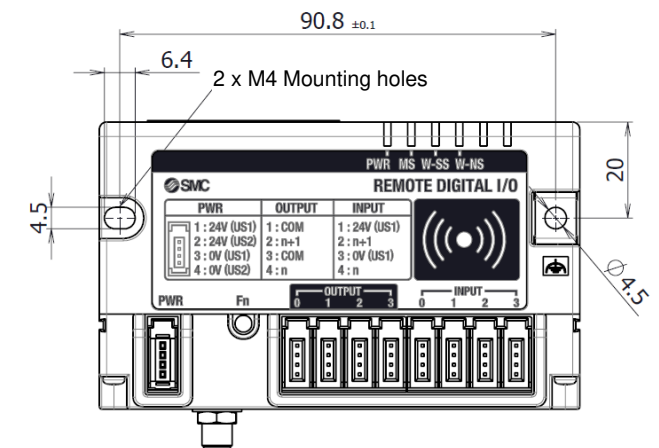

#### 4 Installation (continued)

##### 4.3 Environment

###### Warning

- Do not use in an environment where corrosive gases, chemicals, salt water or steam are present.
- Do not use in an explosive atmosphere.
- Do not expose to direct sunlight. Use a suitable protective cover.
- Do not install in a location subject to vibration or impact in excess of the product's specifications.
- Do not mount in a location exposed to radiant heat that would result in temperatures in excess of the product's specifications.

#### 5 Wiring

##### 5.1 Wiring Connections – EXW1-RDX# Input unit

###### Power supply connector

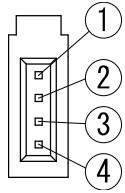

Pin number	Description
1	24V (US1)
2	N.C.
3	0V (US1)
4	N.C.

###### INPUT connector

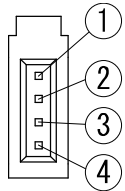

Pin number	Description
1	24V (US1)
2	n+1
3	0V (US1)
4	n

##### 5.2 Wiring Connections – EXW1-RDY# Output unit

###### Power supply connector

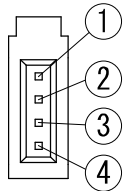

Pin number	Description
1	24V (US1)
2	24V (US2)
3	0V (US1)
4	0V (US2)

###### OUTPUT connector (PNP outputs)

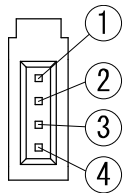

Pin number	Description
1	-COM (US2_0V)
2	n+1
3	-COM (US2_0V)
4	n

\* -COM is connected to 0V (US2) inside the product.

###### OUTPUT connector(NPN outputs)

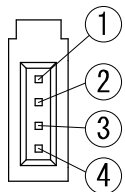

Pin number	Description
1	+COM (US2_24V)
2	n+1
3	+COM (US2_24V)
4	n

\* +COM is connected to 24V (US2) inside the product.

#### 5 Wiring (continued)

##### 5.3 Wiring Connections – EXW1-RDM# Input / Output unit

###### Power supply connector

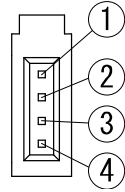

Pin number	Description
1	24V (US1)
2	24V (US2)
3	0V (US1)
4	0V (US2)

###### INPUT connector

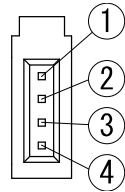

Pin number	Description
1	24V (US1)
2	n+1
3	0V (US1)
4	n

###### OUTPUT connector (PNP outputs)

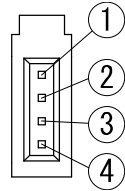

Pin number	Description
1	-COM (US2_0V)
2	n+1
3	-COM (US2_0V)
4	n

\* -COM is connected to 0V (US2) inside the product.

###### OUTPUT connector (NPN outputs)

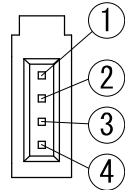

Pin number	Description
1	+COM (US2_24V)
2	n+1
3	+COM (US2_24V)
4	n

\* +COM is connected to 24V (US2) inside the product.

#### 6 Settings

##### Flow chart for using the wireless system.

To use SMC wireless units (Base and Remotes), they need to be set up using an NFC reader/writer and the I/O Configurator. A setup procedure using NFC is shown below. Refer to the operation manual for each manufacturer for how to set the controller and the PLC.

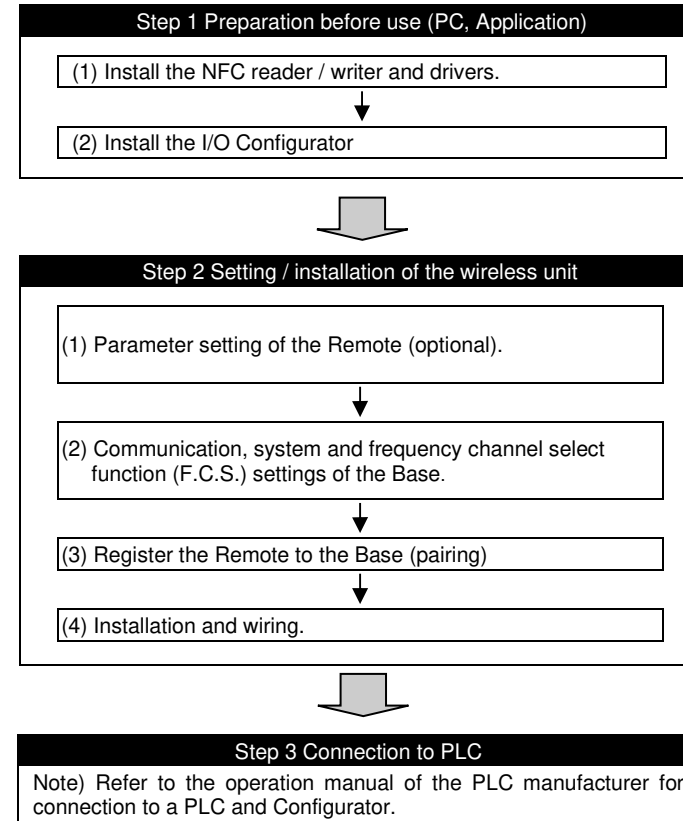

#### 7 LED Display

- The LED indicators on the compact wireless Remote indicate the power supply, communication and diagnostic status. The same LED indications are used for all of the EXW1-RD# series.

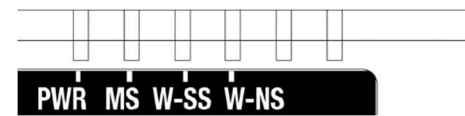

LED	LED Colour	Operation
PWR	Green LED ON	US1 (for control) power supply is ON
	Red LED flashing	US2 (for output) power supply voltage level is abnormal (when the setting is enabled)
	OFF	US1 (for control) power supply is OFF
MS	Green LED ON	Compact wireless Base is operating normally
	Red LED flashing	Recoverable error is detected. (LED flashes when more than one diagnostic information item is detected). <ul style="list-style-type: none"> <li>US1 (for control and input) power supply voltage level is abnormal (when the setting is enabled).</li> <li>Short-circuit detection of US1 (for control / input) power supply.</li> <li>Short-circuit detection of US2 (for output) power supply.</li> </ul>
	Red LED ON	Unrecoverable error is detected.
	OFF	US1 (for control) power supply is OFF.

#### 7 LED Display (continued)

LED	LED Colour	Operation
W-SS	Green LED ON	Received radio wave intensity level 3.
	Green LED flashing (1 Hz)	Received radio wave intensity level 2.
	Green LED flashing (2 Hz)	Received radio wave intensity level 1.
	Red LED flashing	Protocol V.1.0 wireless communication is not established.
	Orange LED flashing	Protocol V.2.0 wireless communication is not established.
	OFF	Wireless Base is not registered.
W-NS	Green LED ON	Wireless Base connected correctly.
	Red LED flashing	Base not connected.
	Orange LED flashing	Pairing operation is in progress.
	Red LED ON	Base not connected (Unrecoverable error in wireless communication).
	Red / Green LED flashing	Wireless communication connection is being configured (Pairing).
	OFF	Base not registered. US1 (for control / input) power supply is OFF.

Refer to the Operation manual on the SMC website (URL: <https://www.smcworld.com>) for further LED Display details.

#### 8 How to Order

Refer to the Operation manual or catalogue on the SMC website (URL: <https://www.smcworld.com>) for How to Order information.

#### 9 Outline Dimensions (mm)

Refer to the Operation manual or catalogue on the SMC website (URL: <https://www.smcworld.com>) for Outline dimensions.

#### 10 Maintenance

##### 10.1 General Maintenance

###### Caution

- Not following proper maintenance procedures could cause the product to malfunction and lead to equipment damage.
- If handled improperly, compressed air can be dangerous.
- Maintenance of pneumatic systems should be performed only by qualified personnel.
- Before performing maintenance, turn off the power supply and be sure to cut off the supply pressure. Confirm that the air is released to atmosphere.
- After installation and maintenance, apply operating pressure and power to the equipment and perform appropriate functional and leakage tests to make sure the equipment is installed correctly.
- If any electrical connections are disturbed during maintenance, ensure they are reconnected correctly and safety checks are carried out as required to ensure continued compliance with applicable national regulations.
- Do not make any modification to the product.
- Do not disassemble the product, unless required by installation or maintenance instructions.

## 11 Limitations of Use

### 11.1 Limited warranty and Disclaimer/Compliance Requirements

Refer to Handling Precautions for SMC Products.

#### NOTE

This equipment has been tested and found to comply with the limits for a Class A digital device, pursuant to Part 15 of the FCC Rules.

These limits are designed to provide reasonable protection against harmful interference when the equipment is operated in a commercial environment.

This equipment generates, uses, and can radiate radio frequency energy and, if not installed and used in accordance with the instruction manual, may cause harmful interference to radio communications.

Operation of this equipment in a residential area is likely to cause harmful interference in which case the user will be required to correct the interference at his own expense.

- **Influence of radio frequency on implantable medical devices:**

The radio frequency generated by this product may give an adverse effect on implantable medical devices, such as implantable cardiac pacemakers and implantable cardioverter defibrillators. Please read catalogues or instruction manuals of the equipment and device which may be affected by radio frequencies for any instructions for use or contact their manufacturers.

## 12 Product Disposal

This product shall not be disposed of as municipal waste. Check your local regulations and guidelines to dispose of this product correctly, in order to reduce the impact on human health and the environment.

## 13 Contacts

Refer to [www.smcworld.com](http://www.smcworld.com) or [www.smc.eu](http://www.smc.eu) for your local distributor / importer.

## SMC Corporation

URL: <https://www.smcworld.com> (Global) <https://www.smceu.com> (Europe)  
SMC Corporation, 4-14-1, Sotokanda, Chiyoda-ku, Tokyo 101-0021, Japan  
Specifications are subject to change without prior notice from the manufacturer.  
© SMC Corporation All Rights Reserved.  
Template DKP50047-F-085N