



ORIGINAL INSTRUCTIONS

Instruction Manual

SMC Wireless System - Compact Base

EtherNet/IP™ compatible

Series EXW1-BENAC1

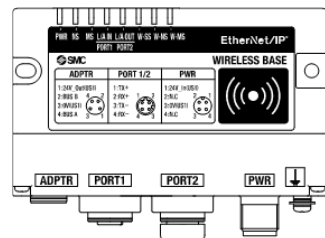

The intended use of this product is to provide a connection from the EtherNet/IP™ communication network to a pneumatic valve manifold or I/O system via wireless communication.

1 Safety Instructions

These safety instructions are intended to prevent hazardous situations and/or equipment damage. These instructions indicate the level of potential hazard with the labels of "Caution," "Warning" or "Danger." They are all important notes for safety and must be followed in addition to International Standards (ISO/IEC)¹⁾, and other safety regulations.

¹⁾ISO 4414: Pneumatic fluid power — General rules and safety requirements for systems and their components.

ISO 4413: Hydraulic fluid power — General rules and safety requirements for systems and their components

IEC 60204-1: Safety of machinery - Electrical equipment of machines. Part 1: General requirements

ISO 10218-1: Robots and robotic devices - Safety requirements for industrial robots - Part 1: Robots

- Keep this manual in a safe place for future reference.
- Refer to the product catalogue, Operation Manual and Handling Precautions for SMC Products for additional information.

	Danger	Danger indicates a hazard with a high level of risk which, if not avoided, will result in death or serious injury.
	Warning	Warning indicates a hazard with a medium level of risk which, if not avoided, could result in death or serious injury.
	Caution	Caution indicates a hazard with a low level of risk which, if not avoided, could result in minor or moderate injury.

Warning

- **Always ensure compliance with relevant safety laws and standards.**
All work must be carried out in a safe manner by a qualified person in compliance with applicable national regulations.

2 Specifications

2.1 Electrical specifications

Item	Specification
Power supply voltage for control (US1)	24 VDC +/-10 %
Current consumption	150 mA or less

2 Specifications (continued)

2.2 General specifications

Item	Specification
Enclosure rating	IP67
Ambient operating temperature	-10 to +50 °C
Ambient storage temperature	-20 to +60 °C
Ambient humidity	35 to 85% RH (no condensation)
Withstand voltage	500 VAC for 1 minute between external terminals (including the FE terminal) and enclosure screws
Insulation resistance	10 MΩ or more (500 VDC between external terminals (including the FE terminal) and enclosure screws)
Vibration resistance	EN61131-2 compliant: 5 ≤ f < 8.4 Hz 3.5 mm 8.4 ≤ f < 150 Hz 9.8 m/s ²
Impact resistance	EN61131-2 compliant: 147 m/s ² , 11 ms
Weight (EXW1-BEN# + A11#)	160 g + 40 g

2.3 EXW1-A11# wireless adaptor specifications

Item	Specification
US1 (for control) power supply voltage	24 VDC +/-10 %
Current consumption	50 mA or less

2.4 EtherNet/IP™ Communication specifications

Item	Specification
Protocol	EtherNet/IP™ (conformance version: Composite19.1)
Number of ports	2ports
Communication medium	100-Base-TX Ethernet cable (CAT5)
Communication speed	10/100 Mbps
Communication type	Full duplex / Half duplex
Configuration file ^{*1}	EDS file
Occupation area (Number of Inputs / outputs)	Max. (1444byte/1444 byte)
IP address setting range	Setting by Manual and DHCP server: arbitrary address
Device information	Vendor ID: 7 (SMC Corporation) Device type: 12 (communicationadapter) Product code: 266
Network Topology	Star, Linear Bus and Ring (including DLR)
EtherNet/IP QuickConnect™	Supported
Web server	Supported
OPC UA	Supported

^{*1}: The EDS configuration file can be downloaded from the SMC website (<https://www.smcworld.com>).

2 Specifications (continued)

2.5 Wireless Communication specifications

Item	Specifications
Protocol	SMC original protocol (SMC encryption)
Radio wave type (spread)	Frequency Hopping Spread Spectrum (FHSS)
Frequency band	2.4 GHz (2403 to 2481 MHz)
Frequency channel select function (F.C.S.)	Supported ^{*1}
Frequency channel	79 ch max. (Bandwidth: 1.0 MHz)
Communication speed	250 kbps (v1.0) / 1 Mbps (v2.0) ^{*2}
Frequency hopping cycle	5ms (v1.0) / 2ms (v2.0)
Communication distance	Up to 100 m line of sight (depending on the environment)
Radio Law certificates	Refer to the official SMC website for the latest information as to which countries the product is certified.

^{*1}: The number of selectable frequency channels varies depending on the product number.

^{*2}: Select a protocol before performing pairing (v2.0: 1 Mbps, v1.0: 250 kbps). Different communication speeds are mutually incompatible.

3 Name and Function of parts

• Compact Base (EXW1-BENAC1)

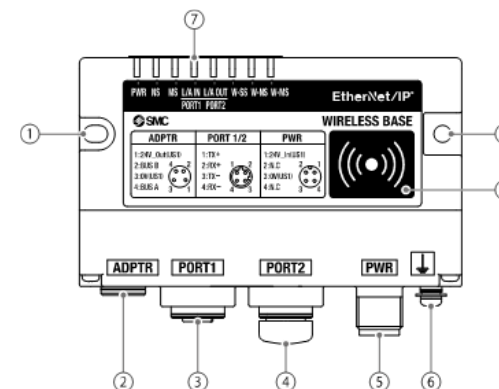

No.	Item	Description
1	Mounting holes	Mounting holes for compact wireless base (2 x M4).
2	ADPTR Connector	Connection for wireless adaptor cable.
3	PORT1 Connector	Connector for Ethernet cable
4	PORT2 Connector	Connector for Ethernet cable
5	Power supply connector	Supplies power to the compact wireless Base.
6	FE terminal	To be connected to Ground (for improved noise immunity).
7	LED display	Indicates the status of the compact wireless Base or Remote.
8	NFC antenna area	Area in close contact with the NFC reader / writer ("o" marks the centre).

3 Name and Function of parts (continued)

• Wireless Adaptor (EXW1-A11#)

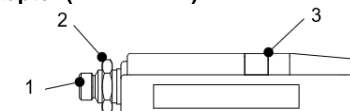

No.	Name	Application
1	Connector	Connector for Wireless Adaptor cable.
2	Nut	For mounting.
3	LED display	Indicates the status of the adaptor.

^{*} Use the wireless adaptor cable specified to connect the wireless adaptor.

• Ground connection

The Ground connection to the FE terminal should be as close as possible to the product and the grounding wire should be as short as possible.

4 Installation

4.1 Installation

Warning

- Do not install the product unless the safety instructions have been read and understood.

4.2 Mounting the Compact Base unit

Mount the Base unit with M4 screws (not supplied) using the 2 mounting holes in the unit (Recommended torque: 0.8 ±10% N·m).

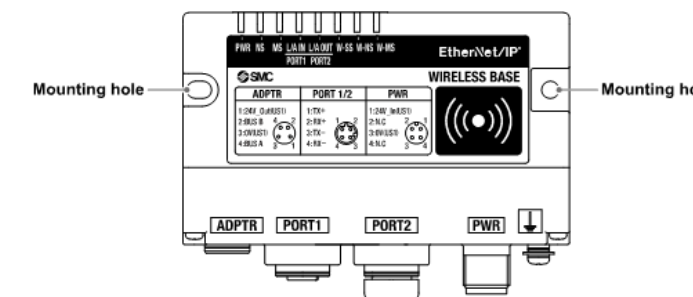

4 Installation (continued)

4.3 Mounting the Wireless Adaptor (EXW1-A11#)

• Integrated type (installation)

- (1) Connection of the base and installation plate.

Secure the installation plate to the base using the two self-tapping screws (M3 x 8) included with the wireless adaptor. The tightening torque should be $0.4 \text{ N}\cdot\text{m} \pm 10\%$.

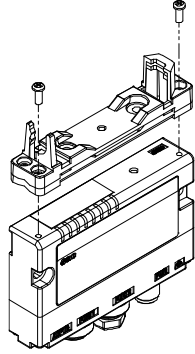

- (2) Installation of wireless adaptor

Clip the wireless adaptor onto the installation plate as shown below and secure the adaptor in place using the M10 nut already fitted to the wireless adaptor. The recommended tightening torque is $0.9 \text{ N}\cdot\text{m} \pm 10\%$.

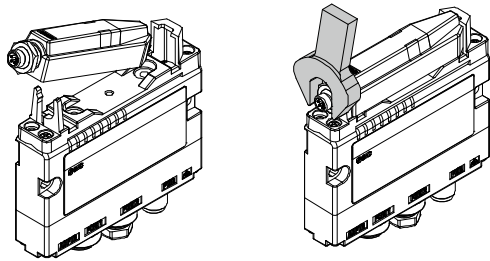

- (3) Connecting the cable for the wireless adaptor

Follow the procedure below to connect the cable for the wireless adaptor.

- 1) Connect the U-side connector of the cable to the base.
- 2) Connect the S-side connector of the cable to the adaptor.

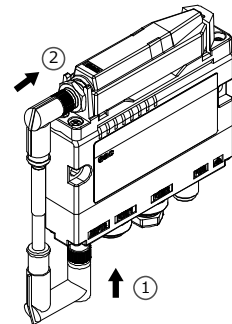

• Mounting on a flat surface

- (1) Attachment of installation plate

Attach the installation plate in the required location using either of the following two methods.

Installation using M3 screws x 4 positions

The recommended tightening torque is $0.4 \text{ N}\cdot\text{m} \pm 10\%$ (screws are not included).

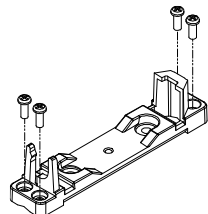

4 Installation (continued)

Installation using M4 screws x 2 positions

The recommended tightening torque is $0.6 \text{ N}\cdot\text{m} \pm 10\%$ (screws are not included).

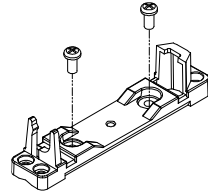

- (2) Installation of wireless adaptor

Clip the wireless adaptor onto the installation plate as shown below and secure the adaptor in place using the M10 nut already fitted to the wireless adaptor. The recommended tightening torque is $0.9 \text{ N}\cdot\text{m} \pm 10\%$.

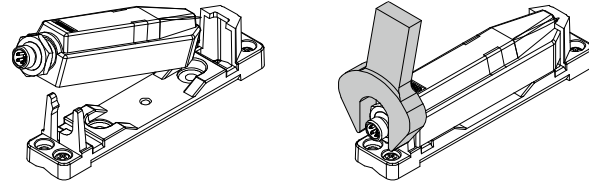

- (3) Connection of the cable for wireless adaptor

Connect the cable between the base / remote and the wireless adaptor.

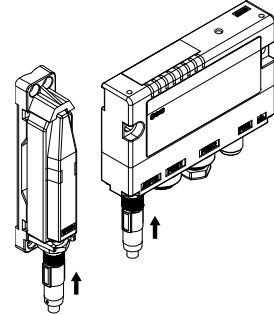

• Mounting on a curved surface

- (1) Thread 2 x cable ties through the installation plate at the top and bottom.
- (2) Secure the wireless adaptor to the installation plate and then secure in the required position by tightening the cable ties.

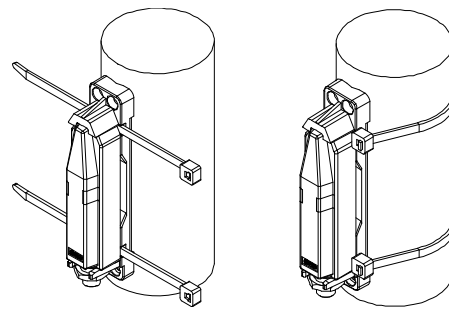

4.4 Environment

Warning

- Do not use in an environment where corrosive gases, chemicals, salt water or steam are present.
- Do not use in an explosive atmosphere.
- Do not expose to direct sunlight. Use a suitable protective cover.
- Do not install in a location subject to vibration or impact in excess of the product's specifications.
- Do not mount in a location exposed to radiant heat that would result in temperatures in excess of the product's specifications.

5 Wiring

5.1 Wiring Connections

Always perform wiring with the power supply turned OFF.

• Power supply connector

No.	Signal	M12, 4-pin, plug	
		A-coded	
1	24V_In (US1)	2	1
2	N.C.		
3	0V (US1)	3	4
4	N.C.		

• EtherNet/IP™ connector (PORT1 / PORT2)

No.	Signal	M12, 4-pin, socket	
		D-coded	
1	TX+	1	2
2	RX-		
3	TX-	4	3
4	RX-		

• Connector for Wireless Adaptor

No.	Signal	M8, 4-pin, socket	
		A-coded	
1	24V Out (US1)	4	2
2	Internal BUS B		
3	0 V (US1)	3	1
4	Internal BUS A		

Caution

- Use the dedicated wireless adaptor cable to connect the compact wireless base to the wireless adaptor.

6 Settings

6.1 Flow chart for using the wireless system

To use SMC wireless units (Base and Remotes), set them up using an NFC reader/writer and the I/O Configurator, as shown below:

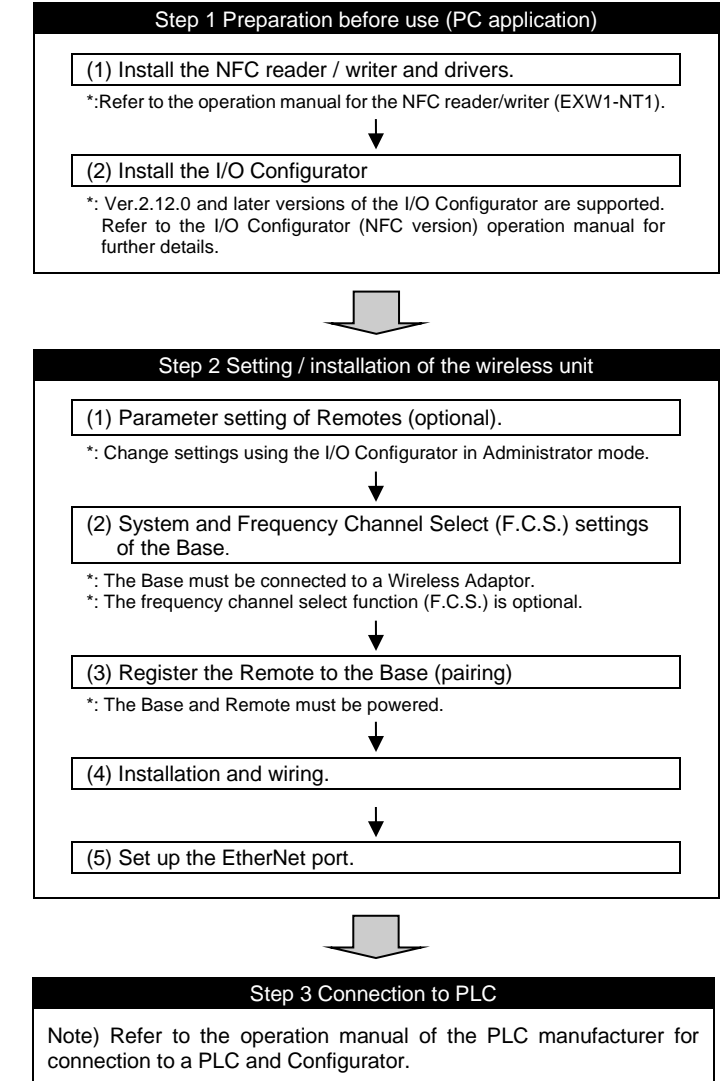

With the above settings it is possible to control the upper level controller. Refer to the operation manual for each manufacturer for how to set the controller and the PLC. Refer to the I/O Configurator (for NFC) operation manual for details of the I/O Configurator.

7 LED Display

7.1 The LED indicators on the Compact Wireless Base indicate the power supply, communication and diagnostic status.

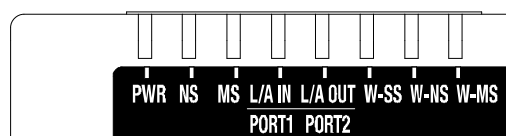

LED	LED status	Operation
PWR	Green LED ON	US1 power supply (for control) is ON.
	OFF	US1 power supply (for control) is OFF.
NS	Green LED ON	EtherNet/IP™ communication is established.
	Green LED flashing	EtherNet/IP™ communication is not established.
	Red LED flashing	EtherNet/IP™ communication time out.
	Red LED ON	Duplicated IP addresses are detected.
	OFF	IP address not set.
MS	Green LED ON	Compact Wireless Base operating normally.
	Red LED flashing	Recoverable error is detected. (LED flashes when more than one diagnostic information item is detected). <ul style="list-style-type: none"> US1 power supply (for control) voltage level is abnormal. Number of system inputs / outputs setting error. Abnormal number of registered Remotes. Internal communication error between wireless adaptors. Memory read / write error. IP address has been duplicated.
	Red LED ON	Unrecoverable error is detected.
	OFF	US1 power supply (for control) is OFF.
L/A IN	Green LED ON	Link, No Activity (100 Mbps)
	Green LED flickering	Link, Activity (100 Mbps)
	Orange LED ON	Link, No Activity (10 Mbps)
	Orange LED flickering	Link, Activity (10 Mbps)
	OFF	EtherNet/IP™ is not connected.
W-SS	Green LED ON	The level of received radio wave strength of all the connected Remotes is 3.
	Green LED flashing (1 Hz)	The level of received radio wave strength of some connected Remotes is 2.
	Green LED flashing (2 Hz)	The level of received radio wave strength of some connected Remotes is 1.
	Red LED flashing	All the Remotes that support protocol V.1.0 are not connected.
	Orange LED flashing	All the Remotes that support protocol V.2.0 are not connected.
	OFF	Remote is not registered.

7 LED Display (continued)

LED	LED status	Operation
W-NS	Green LED ON	All the Remote connections are normal.
	Green LED flashing	Some Remotes are not connected.
	Red LED flashing	No Remotes are connected.
	Red LED ON	No Remotes are connected (Unrecoverable error in wireless communication).
	Red / Green LED flashing	Wireless communication connection is being configured (Pairing mode).
	Orange LED ON	Forced output mode.
	OFF	Remote not registered.
W-MS	Green LED ON	Wireless Remote is normal. Protocol V.1.0 (pairing mode).
	Orange LED ON	Protocol V.2.0 (pairing mode).
	Red LED flashing	Recoverable error is detected. (LED flashes when more than one diagnostic information item is detected). <ul style="list-style-type: none"> US1 power supply (for control / input) voltage level is abnormal. US2 power supply (for output) voltage level is abnormal. Excessive I/O setting inputs/outputs. Analog I/O upper setting limit exceeded. Analog input range upper and lower limits exceeded. Error in communication between units. EX600 I/O unit detects diagnostic information. Valve diagnostic information detected.
	Red LED ON	Unrecoverable error is detected.
	Red LED ON	Unrecoverable error is detected.
	OFF	Remote not registered.

*1: The LED indicator on the NS status is updated only when connected to the PLC/Web.

7.2 The LED indicators on the Wireless Adaptor (EXW1-A11#) indicate the power supply, communication and diagnostic status.

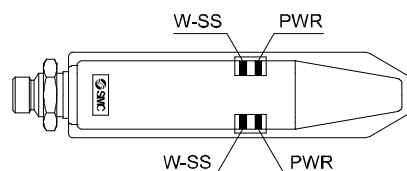

LED	LED status	Operation
PWR	Green LED ON	Power supply voltage is ON.
	Orange LED flashing	Internal communication error is detected.
	Red LED ON	Unrecoverable error is detected.
	OFF	Power supply voltage is OFF.
W-SS	Green LED ON	The level of received radio wave strength of all connected Remotes is 3.
	Green LED flashing (1 Hz)	The level of received radio wave strength of some connected Remotes is 2.
	Green LED flashing (2 Hz)	The level of received radio wave strength of some connected Remotes is 1.
	Red LED flashing	No Remotes that support protocol V.1.0 are connected.
	Orange LED flashing	No Remotes that support protocol V.2.0 are connected.
	OFF	Remote not registered.

8 How to Order

Refer to the Operation manual or catalogue on the SMC website (URL: <https://www.smcworld.com>) for How to Order information.

9 Outline Dimensions (mm)

Refer to the Operation manual or catalogue on the SMC website (URL: <https://www.smcworld.com>) for Outline dimensions.

10 Maintenance

10.1 General Maintenance

Caution

- Not following proper maintenance procedures could cause the product to malfunction and lead to equipment damage.
- If handled improperly, compressed air can be dangerous.
- Maintenance of pneumatic systems should be performed only by qualified personnel.
- Before performing maintenance, turn OFF the power supply and be sure to cut off the supply pressure. Confirm that the air is released to atmosphere.
- After installation and maintenance, apply operating pressure and power to the equipment and perform appropriate functional and leakage tests to make sure the equipment is installed correctly.
- If any electrical connections are disturbed during maintenance, ensure they are reconnected correctly and safety checks are carried out as required to ensure continued compliance with applicable national regulations.
- Do not make any modification to the product.
- Do not disassemble the product, unless required by installation or maintenance instructions.

11 Limitations of Use

11.1 Limited warranty and Disclaimer/Compliance Requirements

Refer to Handling Precautions for SMC Products.

NOTE

This equipment has been tested and found to comply with the limits for a Class A digital device, pursuant to Part 15 of the FCC Rules.

These limits are designed to provide reasonable protection against harmful interference when the equipment is operated in a commercial environment.

This equipment generates, uses, and can radiate radio frequency energy and, if not installed and used in accordance with the instruction manual, may cause harmful interference to radio communications.

Operation of this equipment in a residential area is likely to cause harmful interference in which case the user will be required to correct the interference at his own expense.

• Influence of radio frequency on implantable medical devices:

The radio frequency generated by this product may give an adverse effect on implantable medical devices, such as implantable cardiac pacemakers and implantable cardioverter defibrillators. Please read catalogues or instruction manuals of the equipment and device which may be affected by radio frequencies for any instructions for use or contact their manufacturers.

12 Product Disposal

This product shall not be disposed of as municipal waste. Check your local regulations and guidelines to dispose of this product correctly, in order to reduce the impact on human health and the environment.

13 Contacts

Refer to www.smcworld.com or www.smc.eu for your local distributor / importer.

SMC Corporation

URL: <https://www.smcworld.com> (Global) <https://www.smc.eu> (Europe)
 SMC Corporation, 4-14-1, Sotokanda, Chiyoda-ku, Tokyo 101-0021, Japan
 Specifications are subject to change without prior notice from the manufacturer.
 © SMC Corporation All Rights Reserved.
 Template DKP50047-F-085N