



ORIGINAL INSTRUCTIONS

Instruction Manual

Fieldbus device - SI unit for PROFI-safe

EX260-FPS1

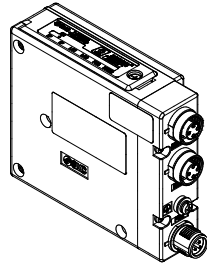
IMPORTANT

When supplied in the European Union or the United Kingdom this document does not contain the necessary safety instructions as required by the Machinery Directive 2006/42/EC or the UK Machinery Safety Regulations 2008.

It is mandatory to refer to the Operation Manual, Document No. EX##-OMY0011 supplied with the product by your local SMC subsidiary for such safety instructions before using this product.

The EU or UKCA Declaration of Conformity is supplied by your local subsidiary with the product.

For other territories the Operation Manual and Declaration of Conformity may be downloaded from the SMC website (URL: <https://www.smcworld.com>).

The intended use of this product is to control pneumatic valves and I/O while connected to the PROFI-safe communication protocol.

1 Safety Instructions

These safety instructions are intended to prevent hazardous situations and/or equipment damage. These instructions indicate the level of potential hazard with the labels of "Caution," "Warning" or "Danger." They are all important notes for safety and must be followed in addition to International Standards (ISO/IEC)¹⁾, and other safety regulations.

¹⁾ISO 4414: Pneumatic fluid power — General rules and safety requirements for systems and their components.

ISO 4413: Hydraulic fluid power — General rules and safety requirements for systems and their components

IEC 60204-1: Safety of machinery - Electrical equipment of machines - Part 1: General requirements

ISO 10218-1: Robotics — Safety requirements — Part 1: Industrial robots

- Refer to product catalogue, Operation Manual and Handling Precautions for SMC Products for additional information.

- Keep this manual in a safe place for future reference.

Danger	Danger indicates a hazard with a high level of risk which, if not avoided, will result in death or serious injury.
Warning	Warning indicates a hazard with a medium level of risk which, if not avoided, could result in death or serious injury.
Caution	Caution indicates a hazard with a low level of risk which, if not avoided, could result in minor or moderate injury.

Warning

- Always ensure compliance with relevant safety laws and standards.**
All work must be carried out in a safe manner by a qualified person in compliance with applicable national regulations.

2 Specifications

The SI (Serial Interface) Unit represents a PROFI-safe on PROFINET IO-device for SMC pneumatic valves. It can be used to implement a safety function for the directly connected valves.

2.1 General specifications

Item	Specifications
Ambient temperature	Operation: -10 to +50 °C Storage: -20 to +60 °C
Ambient humidity	35 to 85%RH (No condensate)
Atmospheric pressure	Operation: 80 kPa to 108 kPa (under 2000 m) Storage: 66 kPa to 108 kPa (under 3500 m)
Withstand voltage	500 VAC applied for 1 minute
Vibration resistance	10 Hz to 57 Hz (constant amplitude) 0.75 mm 57 Hz to 150 Hz (constant acceleration) 49 m/s ² , 2 hours for each direction X, Y and Z.
Insulation resistance	500 VDC, 10 MΩ or more (IEC61131-2)
Impact resistance	147 m/s ² , 3 times each direction X, Y and Z
Operating environment	No corrosive gas
Enclosure	IP67 to IEC 60529
Weight	200 g or less

2.2 Electrical specifications

Item	Specifications	
PWR For logic	Operating voltage	24 VDC +20%/-15%
	Under voltage detection	Detected: < approx. 19 VDC
	Under voltage lockout	< approx. 16 VDC
	Over voltage detection	> approx. 33 VDC
	Over voltage lockout (fuse blown)	> approx. 40 VDC
	Internal current consumption at 24 VDC	0.2 A or less
PWR(V) For valves	Operating voltage	24 VDC +20% / -15%
	Under voltage detection	Detected: < approx. 19 VDC
	Under voltage lockout	< approx. 16 VDC
	Over voltage detection	> approx. 33 VDC
	Over voltage lockout (fuse blown)	> approx. 40 VDC
	Max. current	1.3 A
Voltage drop to valve supply		Max. 1.2 V at 24 VDC
Polarity reversal protection		PWR and PWR(V)
Galvanic isolation		Between PWR and PWR(V)

2.3 Fieldbus specification

Item	Specifications
Bus protocol	PROFI-safe V2.4, PROFINET V2.34
Fast Start Up	Yes
Media Redundancy Protocol	Yes
Shared Device	Yes
Conformance class 3	Yes (Only for IRT switch function)
Vendor ID	0083h
Device ID	000Ch
GSD file	GSDML-V2.35-SMC-EX260-FPS-*****.xml

2.4 Solenoid valve specification

Item	Specifications
Output type	PNP (negative common)
Max. No. of valves	32
Connected load	Solenoid valve with surge voltage suppressor of 24 VDC and 0.95 W or less (manufactured by SMC)
Applicable valve series	SY3000, SY5000, SY7000 JSY1000, JSY3000, JSY5000
Over current protection	Yes
Over current detection	Yes

3 Name and Function of Parts

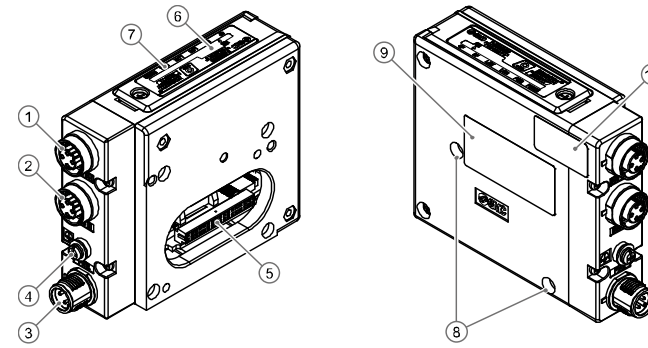

No.	Element	Description
1	PROFINET connection (BUS OUT)	PROFINET connection for Port 2 M12 4-pin socket, D-coded
2	PROFINET connection (BUS IN)	PROFINET connection for Port 1 M12 4-pin socket, D-coded
3	Power supply connection	Power supply for valves and for SI unit logic, M12 4-pin plug, A-coded
4	FE terminal	Functional Earth terminal (M3 screw)
5	Output connector	Output connection for valve manifold
6	F-Address switch	DIP Switch provided for the safety address setting (under switch cover)
7	LED indicators	LED display to indicate SI Unit status
8	Mounting hole	Mounting hole for connection to the valve manifold
9	Production label	Label to indicate the SI Unit information and MAC address
10	Security label	To prevent hardware modification

4 Installation

4.1 Installation

Warning

- Do not install the product unless the safety instructions have been read and understood.
- Connect the SI unit to the valve manifold with the 2 screws on the SI Unit. (hexagonal socket wrench size 2.5).
- Tighten the screws with the specified tightening torque (0.6 N•m).

Assembly of the SI unit to the Valve manifold.

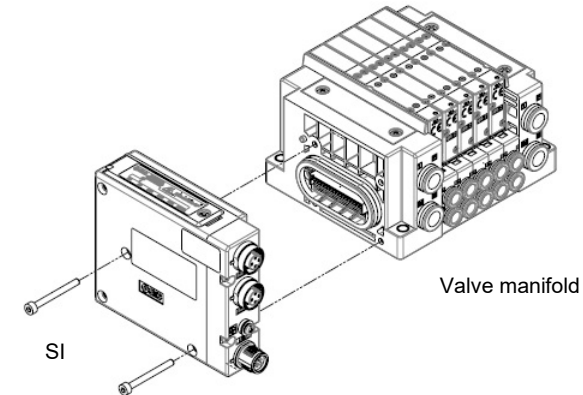
Caution

- To prevent damage, all supply voltages to the SI Unit must be turned OFF (i.e. de-energized) before the modules are installed or removed.
- Check there is no foreign matter inside the SI unit.
- Check there is no damage and no foreign matter on the gasket.
- If the SI unit is not assembled properly, the internal PCBs may be damaged or liquid and/or dust may enter inside the unit.
- To ensure a protection rating of IP67 the recommended tightening torque must be applied.

4 Installation (continued)

4.2 Environment

Warning

- Do not use in an environment where corrosive gases, chemicals, salt water or steam are present.
- Do not use in an explosive atmosphere.
- Do not expose to direct sunlight. Use a suitable protective cover.
- Do not install in a location subject to vibration or impact in excess of the product's specifications.
- Do not mount in a location exposed to radiant heat that would result in temperatures in excess of the product's specifications.

5 Wiring

Connect the Functional Earth (FE) cable, the PROFINET cables and the power cable.

- M12 PROFINET connection BUS OUT (Port2), Port type: MDI-X
- M12 PROFINET connection BUS IN (Port1), Port type: MDI
- M3 Functional Earth (FE) terminal screw (torque = 0.6 N•m)
- M12 Power supply connection.

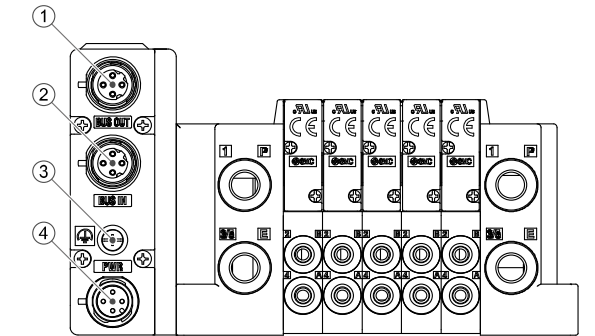

5.1 Fieldbus Interface Connector

The SI Unit has two PROFINET communication connectors.

- BUS IN / OUT: M12 4-pin socket, D-coded**

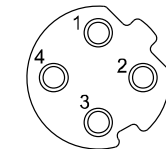

Pin.	BUS IN (Port 1) MDI	BUS OUT (Port 2) MDI-X
1	TD+ Transmit data+	RD+ Receive data+
2	RD+ Receive data+	TD+ Transmit data+
3	TD- Transmit data-	RD- Receive data-
4	RD- Receive data-	TD- Transmit data-

5.2 Power Supply Connector

- Power connector: M12 4-pin plug, A-coded**

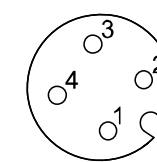

Pin	Signal	Description
1	24 V PWR(V)	24 V solenoid valve
2	0 V PWR(V)	0 V solenoid valve
3	24 V PWR	24 V for SI unit
4	0 V PWR	0 V for SI unit

Caution

- Seal caps must be fitted to all unused BUS connector ports to ensure an IP67 rating.
- IP67 rating must be maintained to guarantee PROFI-safe functionality.
- For reasons of EMC a secure connection to the cable shield must be established on the M12 PROFINET connectors (BUS IN/OUT).

5 Wiring (continued)

- Power and PROFINET cables must be installed correctly.
- The 24 V supply for logic (PWR connector) and the 24 V supply for the valves (PWR(V) connector) should be protected with an external fuse.
- All external supplies should have the 0 V connected to Functional Earth (FE) according to EN 60204-1.
- A functional earth cable must be connected to the M3 terminal.
- If this product is connected using power cables that are more than 30 m long or go outside of a building then external protection devices should be added to protect against electrical surge damage.
- Select the correct cables to mate with the connectors on the SI unit. Cable accessory details can be found in the operation manual on the SMC website (URL: <https://www.smcworld.com>).

5.3 Ground (FE) Connection

The SI Unit must be connected to FE (Functional Earth) to divert electromagnetic interference. Connect a grounding cable from the FE terminal screw on the SI Unit to the nearest functional earth point. The grounding cable should be as thick and short as possible.

6 Settings

6.1 Configuration

In order to configure the SI Unit with the PROFIsafe controller software the appropriate GSD file is required. The GSD file contains all the necessary information to configure the SI Unit.

In order to represent the SI Unit in the PROFIsafe controller software the appropriate symbol file is required.

Current GSD file and symbol files name are as follows.

- GSD file: GSDML-V2.35-SMC-EX260-FPS-*****.xml
- Symbol file: GSDML_0083_EX260_FPS.bmp

For the latest GSD file and other configuration settings refer to the Operation manual on the SMC website (URL: <https://www.smcworld.com>).

7 How to Order

Refer to the product catalogue available on the SMC website (URL: <https://www.smcworld.com>) for the 'How to Order' details.

8 Outline Dimensions (mm)

Refer to the Operation manual available on the SMC website (URL: <https://www.smcworld.com>) for Outline dimensions.

9 LED Display

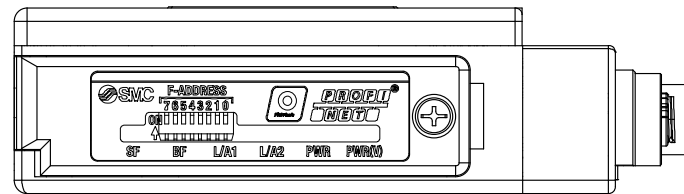

9.1 SF and BF LED's

SF	BF	Meaning
OFF	OFF	No fault (The SI Unit is currently exchanging data with the controller without errors)
	Red Flashing	Faulty or no connect message frame (although the SI Unit is physically connected to Ethernet) <ul style="list-style-type: none"> Configuration is defective, or initial commissioning has not been completed Device name is different from the programmed setting The GSD file is not correct The Controller is defective
---	Red ON	No physical connection on either PROFINET communication connector
Red Flashing at 2 Hz	---	PROFIsafe communication is not established due to the following reason(s) <ul style="list-style-type: none"> No safe communication The SI unit is not parameterized by the Safe controller The parameterization is not acceptable The F-address is not matched
Red Flashing at 0.5 Hz	---	The Safe controller requests operator acknowledgment
Red ON	---	The following diagnostic event(s) occurred <ul style="list-style-type: none"> Power supply is not present or is outside the permissible voltage range. Over voltage lockout safe state entered At least one valve coil has a short circuit Self-test has failed and a power reset is required The PLC mode is stopped

9.2 L/A1 and L/A2 LED's

L/A1 and L/A2	Meaning
Green ON	Connection via Ethernet to the SI Unit via BUS IN / OUT but no transmitting or receiving of Ethernet telegrams on BUS IN / OUT.
Orange ON or Flashing Green / Orange	Connection via Ethernet to the SI Unit via BUS IN/OUT, transmitting or receiving of Ethernet telegrams on BUS IN/OUT.
OFF	No physical connection to the port
Green Flashing	Received "Flash Once" request

9.3 PWR LED

PWR	Voltage	Meaning
OFF	<16 V	PWR is not present
Green Flashing	16 V...19 V	PWR is below the permissible voltage range.
Green ON	19 V...33 V	PWR is present
Red Flashing	33 V...40 V	PWR is above the permissible voltage range.

9 LED Display (continued)

9.4 PWR(V) LED

PWR(V)	Voltage	Safe power supply	Meaning
Yellow ON	<16 V	Not active	<ul style="list-style-type: none"> PWR(V) is not present or below the permissible voltage range Safe power supply (safety output) for the valve is not active
Yellow Flashing	16 V...19 V		
Green Flashing	19 V...33 V	Active	<ul style="list-style-type: none"> PWR(V) is below the permissible voltage range Safe power supply (safety output) for valve is active
Green ON			
Yellow / Green Flashing	33 V...40 V	Not active	<ul style="list-style-type: none"> PWR(V) is present Safe power supply (safety output) for valve is not active
Red / Yellow Flashing			

10 Maintenance

10.1 General Maintenance

Caution

- Not following proper maintenance procedures could cause the product to malfunction and lead to equipment damage.
- If handled improperly, compressed air can be dangerous.
- Maintenance of pneumatic systems should be performed only by qualified personnel.
- Before performing maintenance, turn off the power supply and be sure to cut off the supply pressure. Confirm that the air is released to atmosphere.
- After installation and maintenance, apply operating pressure and power to the equipment and perform appropriate functional and leakage tests to make sure the equipment is installed correctly.
- If any electrical connections are disturbed during maintenance, ensure they are reconnected correctly and safety checks are carried out as required to ensure continued compliance with applicable national regulations.
- Do not make any modification to the product.
- Do not disassemble the product, unless required by installation or maintenance instructions.
- Stop operation if the product does not function correctly.

11 Limitations of Use

11.1 Limited warranty and Disclaimer/Compliance Requirements

Refer to Handling Precautions for SMC Products.

12 Product Disposal

This product shall not be disposed of as municipal waste. Check your local regulations and guidelines to dispose of this product correctly, in order to reduce the impact on human health and the environment.

13 Contacts

Refer to www.smcworld.com or www.smc.eu for your local distributor / importer.

SMC Corporation

URL : <https://www.smcworld.com> (Global) <https://www.smc.eu> (Europe)
 SMC Corporation, 1-5-5, Kyobashi, Chuo-ku, Tokyo 104-0031, JAPAN
 Specifications are subject to change without prior notice from the manufacturer.
 © SMC Corporation All Rights Reserved.
 Template DKP50047-F-0850