



ORIGINAL INSTRUCTIONS

Refer to Declaration of Conformity for relevant Directives

Instruction Manual

High Precision Digital Pressure Switch

56-ISE70 / 56-ISE75(H) series

56-ISE70

II 3G Ex ec IIC T5 Gc 0°C≤Ta≤+50°C
II 3D Ex tc IIC T53°C Dc IP67

56-ISE75(H)

II 3G Ex ec IIC T4 Gc -5°C≤Ta≤+50°C
II 3D Ex tc IIC T54°C Dc IP67

56-ISE70-#-65-#-X508

II 3G Ex ec IIC T4 Gc 0°C≤Ta≤+50°C
II 3D Ex tc IIC T58°C Dc IP67

The intended use of the pressure switch is to measure the pressure of fluid and to provide an output signal.

1 Safety Instructions

These safety instructions are intended to prevent hazardous situations and/or equipment damage. These instructions indicate the level of potential hazard with the labels of "Caution," "Warning" or "Danger." They are all important notes for safety and must be followed in addition to International Standards (ISO/IEC)¹⁾, and other safety regulations.

¹⁾ ISO 4414: Pneumatic fluid power - General rules relating to systems.
ISO 4413: Hydraulic fluid power - General rules relating to systems.
IEC 60204-1: Safety of machinery - Electrical equipment of machines. (Part 1: General requirements)
ISO 10218-1: Manipulating industrial robots -Safety. etc.

- Refer to product catalogue, Operation Manual and Handling

Precautions for SMC Products for additional information.

- Keep this manual in a safe place for future reference.

Caution	Caution indicates a hazard with a low level of risk which, if not avoided, could result in minor or moderate injury.
Warning	Warning indicates a hazard with a medium level of risk which, if not avoided, could result in death or serious injury.
Danger	Danger indicates a hazard with a high level of risk which, if not avoided, will result in death or serious injury.

Warning

- Always ensure compliance with relevant safety laws and standards.
- All work must be carried out in a safe manner by a qualified person in compliance with applicable national regulations.
- This product is class A equipment intended for use in an industrial environment. There may be potential difficulties in ensuring electromagnetic compatibility in other environments due to conducted or radiated disturbances.
- Refer to the operation manual on the SMC website (URL: <https://www.smcworld.com>) for more information regarding safety instructions.

1 Safety Instructions (continued)

1.1 Ex Safety Instruction

Ex Marking Description	II 3G Ex ec IIC T5 Gc 0°C≤Ta≤+50°C II 3D Ex tc IIC T53°C Dc IP67
Equipment Group II	tc - Protected by enclosure
Category 3	IIC - For all types of dust
Gas (G) and Dust (D) environment	T53°C - Max. surface temp. Gc/Dc - EPL
Ex - European standards apply	Ta - ambient temperature
ec - Increased safety	IP67 - Degree of protection
IIC - For all types of Gas	
T5 - Temperature classification	

Based on the conformity assessment carried out by SMC Corporation.

Certificate Number: SMC 20.0029 X

If the Certificate number includes an X, special conditions for safe use apply as follows :-

- Protect the product from sources of heat which can generate surface temperatures greater than the temperature classification.
- Protect the product and cable against all impact or mechanical damage.
- Protect the product from direct sunlight or UV light using a suitable protective cover.
- Do not disconnect the M12 connector before first switching OFF the power supply.
- Use only a damp cloth to clean the product to avoid an electrostatic charge.
- Provide suitable grounding to avoid electrostatic charge.

2 Names of Individual parts

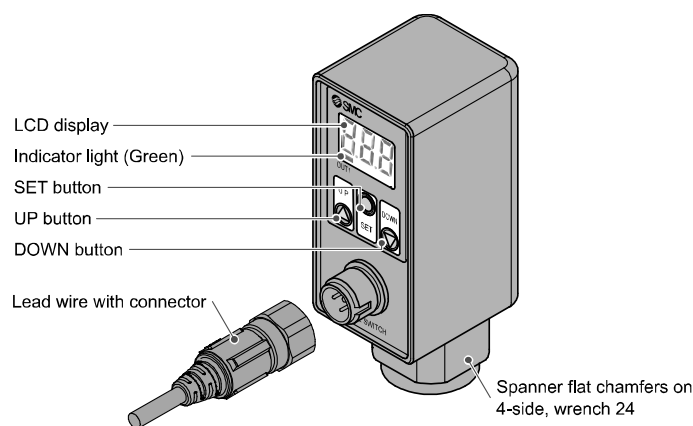

Part	Description
Indicator Light	Displays the switch operating condition. LED is ON when output OUT1 is ON.
LCD display	Displays the current status of pressure, setting mode and error code. 4 display modes can be selected: display always in red or green, changing from green to red, red to green linked to the output.
UP button	Increases mode and ON/OFF set values. Change to peak display value.
DOWN button	Decreases mode and ON/OFF set values. Change to bottom display value.
SET button	Changes the mode and sets the value.

3 Specifications

3.1 General specifications

Product No.	56-ISE70	56-ISE75	56-ISE75H	
Applicable fluid	Air, inert and incombustible gas	Fluid with no corrosive effect on SUS304/430/630		
Pressure	Rated pressure range	0 to 1 MPa	0 to 10 MPa / 0 to 15 MPa	
	Set pressure range	-0.1 to 1 MPa	0.4 to 10 MPa / 0.5 to 15 MPa	
	Withstand pressure	1.5 MPa	30 MPa / 45 MPa	
	Minimum setting unit	0.01 MPa	0.1 MPa	
Electrical	Power supply voltage	12 to 24 VDC ±10% 10% ripple (p-p) or less		
	Current consumption	55 mA or less (with no load)		
Accuracy	Protection	Polarity protection		
	Display accuracy	±2% F.S. ±1 digit (at 25 ±3 °C)		
	Repeatability	±0.5% F.S.		
Switch output	Temperature characteristics (@ 25 °C)	±2% F.S.	±3% F.S.	
	Output type	NPN or PNP open collector output.		
Switch output	Output mode	Hysteresis mode or window comparator mode.		
	Max. Load current	80 mA		
	Max. Applied voltage	30 V (NPN output)		
	Internal voltage drop (Residual voltage)	1.0 V or less (80 mA load current)		
	Response time	2.5 ms or less (anti-chatter function selectable)		
	Protection	Short circuit protection		
Hysteresis or Window comparator mode	Variable from 0			
Display method	3 digits 7-segment dual-colour display (Red/Green), Display colour can be linked to switch output			
Indicator light	OUT1: LED ON when output ON (Green) OUT2: LED ON when output ON (Red)			
Functions	Anti-chatter, display unit conversion, Zero clear, Key lock			
Environment	Enclosure rating	IP67 (IEC 60259)		
	Medium temperature	0 to 50°C	-5 to 80°C	
	Ambient temperature	(no condensation or freezing)		
	Storage temperature	0 to 50°C	-5 to 50°C	
	Ambient humidity	(no condensation or freezing)		
	Withstand voltage	1000 VAC 1 min.	250 VAC, 1 min.	
	Insulation resistance	50 MΩ min. (at 500 VDC)	50 MΩ min. (at 50 VDC)	
Material in contact with fluid	C3604, PBT, Silicone, NBR	SUS304	SUS630, SUS304 (Rc1/4), SUS430 (NPT1/4, G1/4)	
Port size	Rc1/4, NPT1/4 or G1/4			
Weight (excluding lead wire)	190 g	225 g	225 g (Rc1/4) 210 g (NPT1/4, G1/4)	

4 Installation

4.1 Installation

Warning

- Do not install the product unless the safety instructions have been read and understood.
- Do not disassemble, modify (including changing the printed circuit board) or repair. An injury or failure can result.
- Do not operate the product outside of the specifications. Do not use for flammable or harmful fluids. Fire, malfunction or damage to the product can result.
- If using the product in an interlocking circuit: Provide a double interlocking system, for example a mechanical system.

4.2 Environment

Warning

- Do not use in an environment where corrosive gases, chemicals, salt water or steam are present.
- Do not install in a location subject to vibration or impact in excess of the product's specifications.
- Do not mount in a location exposed to radiant heat that would result in temperatures in excess of the product specification.

4.3 Mounting with Bracket

Mount the product using bracket (ZS-31-A) around the fitting, then set the product in the required position using M6 screws. If the panel is less than 5 mm thick, use M6 nuts to reinforce the mounting.

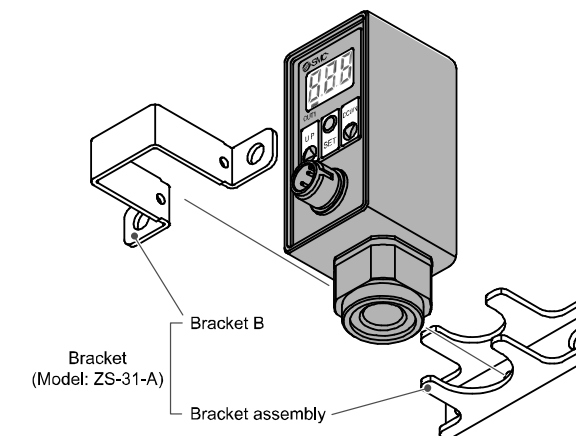

4.4 Piping

Caution

- Before connecting piping make sure to clean up chips, cutting oil, dust etc.
- When piping, tighten to the recommended torque: 13.6 to 15 N·m for ISE70 series and 25 to 28 N·m for ISE75/75H series

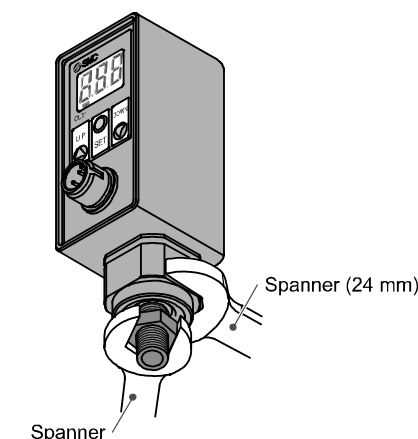

4 Installation (continued)

4.5 Wiring

- Connections should be made with the power supply turned off.
- Use a separate route for the product wiring and any power or high voltage wiring. Otherwise, malfunction may result due to noise.
- If a commercially available switching power supply is used, be sure to ground the frame ground (FG) terminal. If the switching power supply is connected, switching noise will be superimposed and it will not be able to meet the product specifications. In that case, insert a noise filter such as a line noise filter/ferrite between the switching power supplies or change the switching power supply to the series power supply.
- **Connector mounting / removal**
Align the cable connector key groove with the product connector key to insert and rotate the knurled part of the connector.

M12 Connector Pin layout

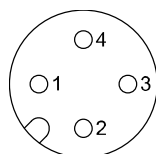

56-ISE70/75(H)-##-43

No.	Colour	Function
1	Brown	DC (+)
2	White	OUT2 (PNP)
3	Blue	DC (-)
4	Black	OUT1 (NPN)

56-ISE70/75(H)-##-65

No.	Colour	Function
1	Brown	DC (+)
2	White	N.C.
3	Blue	DC (-)
4	Black	OUT1 (PNP)

56-ISE70/75(H)-##-27 / -67

No.	Colour	Function
1	Brown	DC (+)
2	White	OUT2 (NPN or PNP)
3	Blue	DC (-)
4	Black	OUT1 (NPN or PNP)

56-ISE70/75(H)-##-65-X508

No.	Colour	Function
1	Brown	DC (+)
2	White	OUT2 (4 to 20mA)
3	Blue	DC (-)
4	Black	OUT1 (PNP)

5 Settings

Power is supplied

Measurement mode

Detects pressure, displays values and performs switching. Other functions such as zero clear can also be set if necessary.

Initial setting

Setting the output mode, LCD display colour, and response time.

Pressure Setting

Input of set value for pressure to perform switch output.

Measurement mode

5.1 Initial Setting

Press and hold the SET button for 2 seconds or longer.

The display shown right will appear to allow operating the initial setting mode.

Finish initialization and return to measurement mode by no operation for 30 seconds or pressing the SET button for 2 seconds or longer.

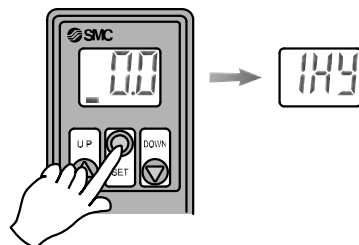

5 Settings (continued)

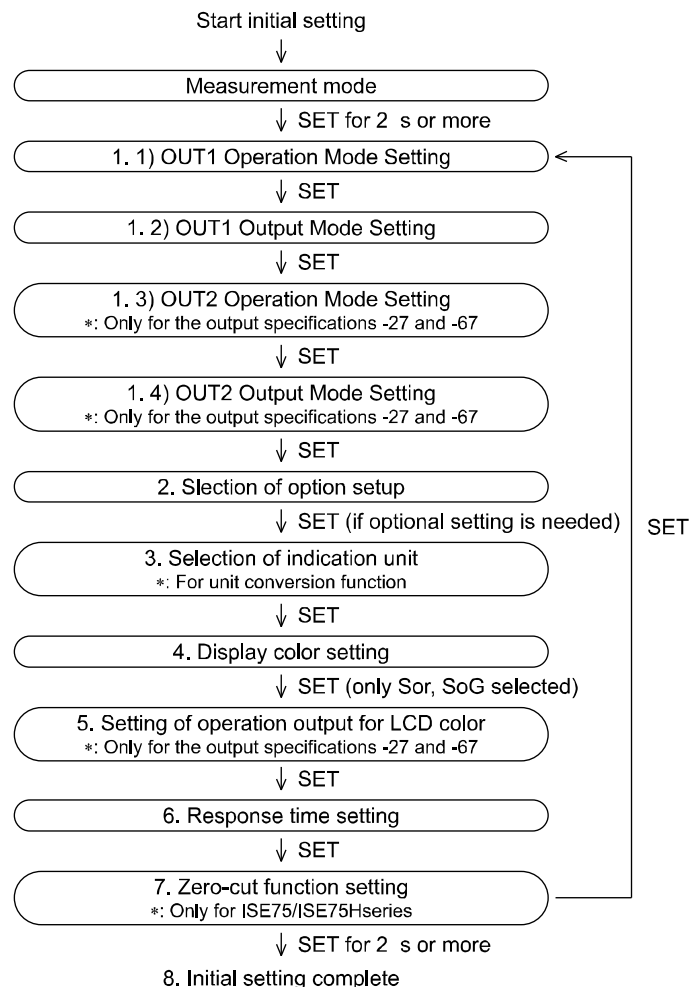

6 Pressure Setting

• Pressure input mode for OUT1

Press the SET button in measurement mode to display set values. [P_1] or [n_1] and the current set value will flash in turn. Press the SET button to display the next set value (Hysteresis: H_1). Press the UP or DOWN button to enter the value change mode.

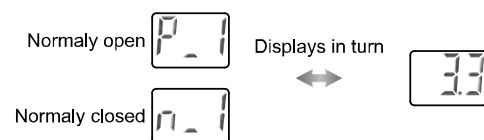

• When hysteresis mode is set

If the hysteresis mode is set, [H_1] and the set value of hysteresis will appear in turn after the setting for [P_1] or [n_1]. Press the SET button to return to normal measurement mode. Press the UP or DOWN button to enter the value change mode.

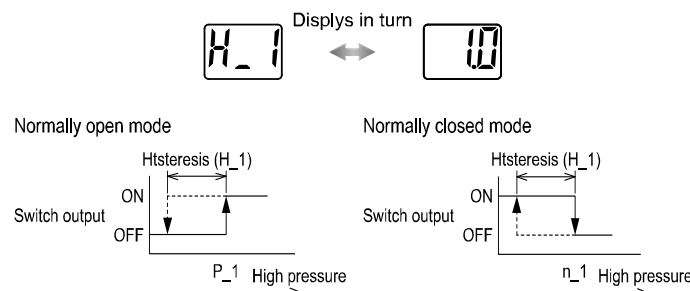

If the hysteresis is set to 2 digits or less, the switch output may chatter if input pressure fluctuates near the set value.

6 Pressure Setting (continued)

• When window comparator mode is set

If the Window comparator mode is set, [P_2] or [n_2] and the current set value will appear in turn after the setting for [P_1] or [n_1]. Press the SET button to display the next set value. (Hysteresis: H_1) Press the UP or DOWN button to enter the value change mode. Next, [H_1] and the set value of Hysteresis will appear in turn. Press the SET button to return to measurement mode. Press the UP or DOWN button to enter the value change mode.

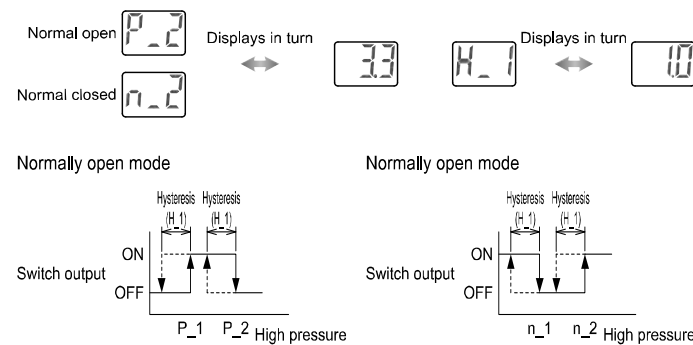

If the initialized value is normally open mode, [P_1] will appear, and [n_1] will appear if it is normally closed mode. The set pressure can be checked without holding or stopping switch output operation.

7 Other Settings

- Fine adjustment mode
- Peak / Bottom value display
- Key lock function
- Zero Clear function

Refer to the operation manual on the SMC website (URL: <https://www.smcworld.com>) for further details of how to set these and other functions.

8 Maintenance

8.1 General Maintenance

Caution

- Not following proper maintenance procedures could cause the product to malfunction and lead to equipment damage.
- If handled improperly, compressed air can be dangerous.
- Maintenance of pneumatic systems should be performed only by qualified personnel.
- Before performing maintenance, turn off the power supply and be sure to cut off the supply pressure. Confirm that the air is released to atmosphere.
- After installation and maintenance, apply operating pressure and power to the equipment and perform appropriate functional and leakage tests to make sure the equipment is installed correctly.
- If any electrical connections are disturbed during maintenance, ensure they are reconnected correctly and safety checks are carried out as required to ensure continued compliance with applicable national regulations.

How to reset the product after power cut or forcible de-energizing

The setting of the product will be retained as it was before a power cut or de-energizing. The output condition is also basically recovered to that before a power cut or de-energizing, but may change depending on the operating environment.

Therefore, check the safety of the whole installation before operating the product. If the installation is using accurate control, wait until the product has warmed up (approximately 20 to 30 minutes).

9 Troubleshooting

9.1 Error Indication

Error	Error displayed	Description	Measures
Over current OUT1	Er1	The load current applied to the switch output has exceeded 80 mA.	Turn the power off and remove the cause of the over current. Then turn the power on.
Over current OUT2	Er2		
Residual pressure error	Er3	During zero clear operation, pressure over $\pm 7\%$ F.S. is applied. After 3 s, the mode will reset to the measurement mode. ± 1 digit of the zero clear range varies with individual product differences.	Perform zero clear operation again after restoring the applied pressure to an atmospheric pressure condition.
Pressure error	HHH	Pressure has exceeded the upper limit of the set pressure range.	Reset applied pressure to a level within the set pressure range.
	LLL	Pressure has exceeded the lower limit of the set pressure range.	
System error	Er4 Er6 Er7 Er8	Displayed if an internal data error has occurred.	Turn the power off and on again. If the failure cannot be solved, contact SMC.

If the error cannot be reset after the above measures are taken, or errors other than the above are displayed, please contact SMC.

10 Limitations of Use

10.1 Limited warranty and Disclaimer/Compliance Requirements

Refer to Handling Precautions for SMC Products.

11 Product Disposal

This product shall not be disposed of as municipal waste. Check your local regulations and guidelines to dispose of this product correctly, in order to reduce the impact on human health and the environment.

12 Contacts

Refer to www.smcworld.com or www.smc.eu for your local distributor / importer.

SMC Corporation

URL : <https://www.smcworld.com> (Global) <https://www.smc.eu> (Europe)
SMC Corporation, Akinabara UDX15F, 4-14-1, Sotokanda, Chiyoda-ku, Tokyo 101 0021
Specifications are subject to change without prior notice from the manufacturer.
© 2021-2022 SMC Corporation All Rights Reserved.
Template DKP50047-F-085L