



ORIGINAL INSTRUCTIONS



Refer to Declaration of Conformity for relevant Directives

Instruction Manual
ISO Standard Air Cylinder
55-C96 Series

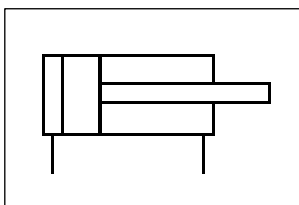
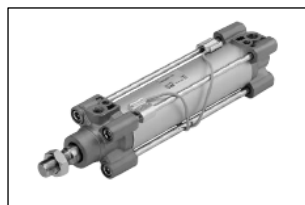

CE Ex II 2GD	Ex h IIC T5/T4 Gb	-10°C ≤ Ta ≤ +60°C
	Ex h IIC T86°C/T106°C Db	

Product marking shown above is for the standard product.

ATEX Marking Description:

Ex	Specific Marking for Explosion Protection
II	Equipment Group
2	Equipment Category
GD	Environment (Gas/Dust)
Ex h	General Protection Level Symbols
IIC	Gas Sub-Division
IIIC	Dust Sub-Division
T	Temp. Classification
Gb/Db	Equipment Protection Level
X	Special Conditions of Use
Ta	Ambient Temperature Range

The intended use of this ATEX Category 2 ISO actuator is to convert the potential energy provided by compressed air into a force which causes mechanical linear motion.

Certificate Number:	SMC19.0035 X
---------------------	--------------

Note 1: The X at the end of the certificate number represents that this product is subject to "Special Conditions of Use", please see Section 2.3.

1 Safety Instructions

These safety instructions are intended to prevent hazardous situations and/or equipment damage. These instructions indicate the level of potential hazard with the labels of "Caution," "Warning" or "Danger." They are all important notes for safety and must be followed in addition to International Standards (ISO/IEC^{*)}, and other safety regulations.

^{*)} ISO 4414: Pneumatic fluid power - General rules relating to systems.
ISO 4413: Hydraulic fluid power - General rules relating to systems.
IEC 60204-1: Safety of machinery - Electrical equipment of machines. (Part 1: General requirements)
ISO 10218-1: Manipulating industrial robots - Safety, etc.

- Refer to product catalogue, Operation Manual and Handling Precautions for SMC Products for additional information.
- Keep this manual in a safe place for future reference.

Caution	Caution indicates a hazard with a low level of risk which, if not avoided, could result in minor or moderate injury.
Warning	Warning indicates a hazard with a medium level of risk which, if not avoided, could result in death or serious injury.
Danger	Danger indicates a hazard with a high level of risk which, if not avoided, will result in death or serious injury.

Warning

- Always ensure compliance with relevant safety laws and standards.
- All work must be carried out in a safe manner by a qualified person in compliance with applicable national regulations.

2 Specifications

This product is certified to ATEX Category 2GD and therefore is suitable for use in Zones 1, 2, 21 and 22 only.

2.1 Product Specifications:

Refer to the operation manual for this product;

2.1.1 Standard Product:

Fluid	Air	
Max. Operating Pressure	1.0 MPa	
Min. Operating Pressure	0.05 MPa	
Ambient & Fluid Temperature	-10°C to +60°C	
Lubrication	Not Required	
Operating Piston Speed	Ø32 ~ Ø100	50 to 1000 mm/s
	Ø125	50 to 700 mm/s
Cushion	Air Cushion	
Allowable Kinetic Energy	Ø 32	2.2 J
	Ø 40	3.4 J
	Ø 50	5.9 J
	Ø 63	11.0 J
	Ø 80	20.0 J
	Ø 100	29.0 J
Ø 125	32.3 J	

2.1.2 Smooth Variant:

Fluid	Air	
Max. Operating Pressure	0.7 MPa	
Min. Operating Pressure	Ø 32 ~ Ø 40	0.02 MPa
	Ø 50 ~ Ø100	0.01 MPa
Ambient & Fluid Temperature	-10°C to +60°C	
Lubrication	Not Required	
Operating Piston Speed	5 to 500 mm/s	
Cushion	None	
Allowable Kinetic Energy	Ø 32	2.2 J
	Ø 40	3.4 J
	Ø 50	5.9 J
	Ø 63	11.0 J
	Ø 80	20.0 J
	Ø 100	29.0 J
Ø 125	32.3 J	

2.2 Production Batch Code:

The batch code printed on the label indicates the month and the year of production as per the following table;

Production Batch Codes									
Year	2017	2018	2019	...	2021	2022	2023	...	
Month	V	W	X	...	Z	A	B	...	
Jan	O	Vo	Wo	Xo	...	Zo	Ao	Bo	...
Feb	P	VP	WP	XP	...	ZP	AP	BP	...
Mar	Q	VQ	WQ	XQ	...	ZQ	AQ	BQ	...
Apr	R	VR	WR	XR	...	ZR	AR	BR	...
May	S	VS	WS	XS	...	ZS	AS	BS	...
Jun	T	VT	WT	XT	...	ZT	AT	BT	...
Jul	U	VU	WU	XU	...	ZU	AU	BU	...
Aug	V	VV	WV	XV	...	ZV	AV	BV	...
Sep	W	VW	WW	XW	...	ZW	AW	BW	...
Oct	X	VX	WX	XX	...	ZX	AX	BX	...
Nov	Y	Vy	Wy	Xy	...	Zy	Ay	By	...
Dec	Z	VZ	WZ	XZ	...	ZZ	AZ	BZ	...

2.3 Special Conditions of Use:

- Products are suitable for sub-divisions IIC & IIIC.
- Products are suitable for Zones 1, 2, 21 & 22 only.

2.3.1 Temperature Marking:

2.3.1.1 Standard Product:

- In the normal ambient temperature range (-10°C to +40°C) the product is rated to temperature class T5 and has a maximum surface temperature of 86°C.
- In the special ambient temperature range (+40°C to +60°C) the product is rated to temperature class T4 and has a maximum surface temperature of 106°C.

2.3.1.2 Smooth Variant:

- In the normal ambient temperature range (-10°C to +40°C) the product is rated to temperature class T5 and has a maximum surface temperature of 86°C.

- In the special ambient temperature range (+40°C to +60°C) the product is rated to temperature class T4 and has a maximum surface temperature of 106°C.

3 Installation

3.1 Installation

Warning

- Do not install the product unless the safety instructions have been read and understood.
- Do not twist or bend the cylinder, or mount the product when subject to tension.
- Do not use in an application where the product is stopped mid-stroke, via an external stop.
- Do not use where cylinders are being synchronised to move a single load.
- In order to install the product, use one of the brackets available found in the standard product catalogue;

Mounting Bracket [Part Number]	Sketch	Mounting Bracket [Part Number]	Sketch
Axial Foot [L5xxx]		Clevis Pivot Bracket [E5xxx]	
Flange [F5xxx]		Single Clevis w/ Ball Joint [CS5xxx]	
Single Clevis [C5xxx]		Double Clevis Pivot Bracket [DS5xxx]	
Double Clevis [D5xxx]		Clevis Pivot Bracket w/ Ball Joint [ES5xxx]	

Note 2: The "xxx" represents the Bore Size (e.g. Ø40 is 040), see catalogue for more details.

- When replacing brackets use the hexagon wrench and torques shown below;

Bore [mm]	Bolts	Width Across Flats [mm]	Tightening Torque [N.m]
Ø 32 & Ø 40	MB-32-48-C1247	4	4.8
Ø 50 & Ø 63	MB-50-48-C1249	5	10.4
Ø 80 & Ø 100	MB-80-48AC1251	6	18.2
Ø 125	M12x1.75x25L	10	28.5

Rod End Accessories	Sketch	Series
Floating Joint		JA
Rod Clevis		GKM
Rod End		KJ

Note 3: See the product catalogue for the exact code to order which relates to the bore size of your product.

- Tighten these accessories with a suitable wrench using the flat surfaces provided. Ensure that they are tightened against the rod end nut to prevent the accessory coming loose during operation.

Bore [mm]	Width Across Flats [mm]		
	Floating Joint	Clevis	Ball Joint
Ø 32	17	20	17
Ø 40	22	24	19
Ø 50 & Ø 63	27	32	22
Ø 80 & Ø 100	32	40	30
Ø 125	41	55	41

3.2 Environment

Warning

- Do not use in an environment where corrosive gases, chemicals, water, salt water or steam are present.
- Do not use in an explosive atmosphere except within the specified rating.
- Do not expose to direct sunlight. Use a suitable protective cover.

- Do not install in a location subject to vibration or impact in excess of the product's specifications.
- Do not use in a place subject to heavy vibration and/or shock.
- Do not use in wet environments, where water can remove the presence of the lubrication.
- Do not use in case of heavy dusty environments where dust can penetrate into the cylinder and dry the grease.
- Do not allow dust layers to build up on the cylinder surface and insulate the product.

3.3 Piping

Caution

- Before connecting piping make sure to clean up chips, cutting oil, dust etc.
- When installing piping or fittings, ensure sealant material does not enter inside the port. When using seal tape, leave 1 thread exposed on the end of the pipe/fitting.
- Tighten fittings to the specified tightening torque.

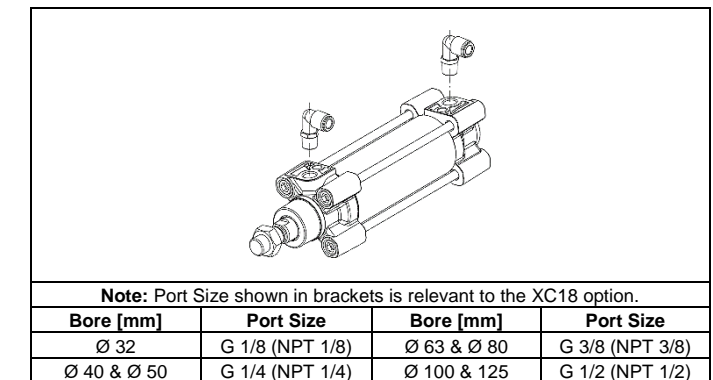

3.4 Lubrication

Caution

- SMC products have been lubricated for life at manufacture, and do not

require lubrication in service.

- If a lubricant is used in the system, refer to catalogue for details.

3.5 Basic Circuit

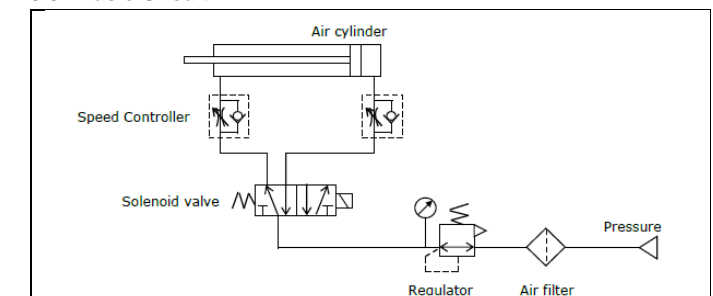

- Plugging one of the ports on the actuator is considered a non-intended use, and could relate to an increase in maximum surface temperature above what the product specification declares.

3.6 Electrical Connection

- The product should be grounded by the piston rod and the body in order to create an electrically conductive path to the system/application.
- Ground the product in accordance with applicable regulations.
- Do not pass an electrical current through the product.

4 Settings

4.1 Air Cushion Adjustment

- For air cushion adjustment, tighten or loosen the cushion valve using a suitable hexagon socket screw key as listed in the table below.
- Do not open the cushion valve more than the allowable number of rotations.

The cushion valves are provided with a crimp (Ø32) or snap ring (Ø40-Ø125) as a stopping mechanism. Although the cushion valve is caulked as a retaining mechanism, do not open the cushion valve more than the allowable number of rotations. If air is supplied and operation started without confirming the above condition, the cushion may be ejected from the valve cover. The allowable number of rotations refers to the number of rotations until the restrictor of the cushion valve is completely opened from the completely closed state.

- Keep the screwing torque and the unscrewing torque of the cushion valve to the allowable torque as shown in the table below. If a screwing or unscrewing torque beyond the allowable torque is applied, the valve will be damaged when the valve is closed completely or exceeds the retaining mechanism when the valve is opened completely, which will dislocate the engagement of the screw and eject the valve.

Be certain to activate the air cushion at the stroke end. When the air cushion is inactivated, if the allowable kinetic energy exceeds the maximum allowable value, the piston-rod assembly or the tie rod may be damaged. Set the air cushion to valid when operating the cylinder.

Bore [mm]	Cushion Valve Width Across Flats [mm]	Hexagon Wrench
Ø 32 Ø 40	2.5	JIS 4648 Hexagon socket screw key 2.5
Ø 50 Ø 63	3	JIS 4648 Hexagon socket screw key 3
Ø 80 Ø 100 Ø 125	4	JIS 4648 Hexagon socket screw key 4

- Do not operate the cushion valve in the fully closed or fully opened state.

Using it in the fully closed state will cause the cushion seal to be damaged. Using it in the fully opened state will cause the piston rod assembly or the cover to be damaged.

- If the cushion valve is used in the fully open position adjust the speed and load to below the values given in the table below.

Load	Speed [mm/s]
80% of theoretical output with pressure of 1.0 MPa	130
40% of theoretical output with pressure of 1.0 MPa	190
15% of theoretical output with pressure of 1.0 MPa	300

- Cushion adjustment is not necessary on the smooth cylinder (Y type).

5 How to Order

Refer to the standard product catalogue for 'How to Order'.

6 Outline Dimensions (mm)

Refer to the standard product catalogue for general dimensions.

7 Maintenance

7.1 General Maintenance

Caution

- Not following proper maintenance procedures could cause the product to malfunction and lead to equipment damage.
- If handled improperly, compressed air can be dangerous.
- Maintenance of pneumatic systems should be performed only by qualified personnel.
- Before performing maintenance, turn off the power supply and be sure to cut off the supply pressure. Confirm that the air is released to atmosphere.
- After installation and maintenance, apply operating pressure and power to the equipment and perform appropriate functional and leakage tests to make sure the equipment is installed correctly.
- If any electrical connections are disturbed during maintenance, ensure they are reconnected correctly and safety checks are carried out as required to ensure continued compliance with applicable national regulations.
- Do not make any modification to the product.
- Do not disassemble the product, unless required by installation or maintenance instructions.
- Do not use a product which looks or contains damage, this will invalidate the certification. If damage is seen, please replace the product immediately.
- Periodically check the product for any damage or rust appearing. This could result in an increase in friction and lead to dangerous conditions. Replace the whole actuator if any of these conditions appear.
- Periodically check the condition of the rod seal and for the presence of lubrication, where possible. If these areas appear to be dry, please follow the lubrication procedure.

- Replace the seals, when air leakage is above the allowable value given in the table below;

	Allowable Leakage
Internal Leakage	Standard = 10 cm ³ / min (ANR) Smooth = 500 cm ³ / min (ANR)
External Leakage	5 cm ³ / min (ANR)

7.2 Disassembly Procedure

- Loosen and disassemble the tie rods and tie rod nuts using suitable wrenches. The table below lists the width across flats of the tie rod nuts.

Bore [mm]	Width Across Flats [mm]	Tool
Ø 32 & Ø 40	6	Hexagon Socket Screw Key
Ø 50 & Ø 63	8	
Ø 80 & Ø 100	14	Socket Wrench
Ø 125	17	

- Separate the covers, cylinder tube and piston rod assembly.
- Clear away the old grease and place all of the parts on a clean cloth in a clean environment.
- Remove the old tube gaskets, rod seal, cushion seals, piston seal and wear ring using a fine screwdriver where necessary.

Caution

- If a magnet is present on the piston do not remove it. The magnet is not replaceable.

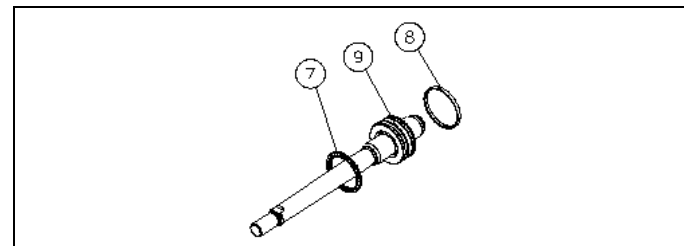
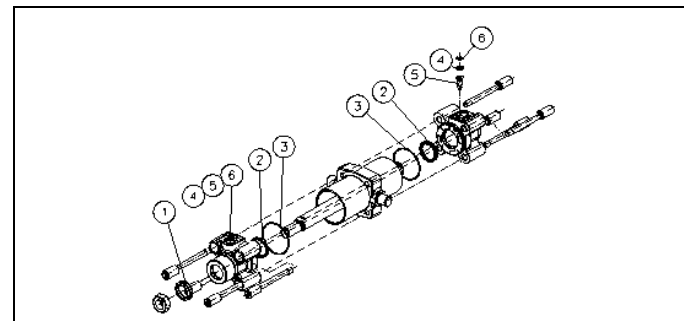
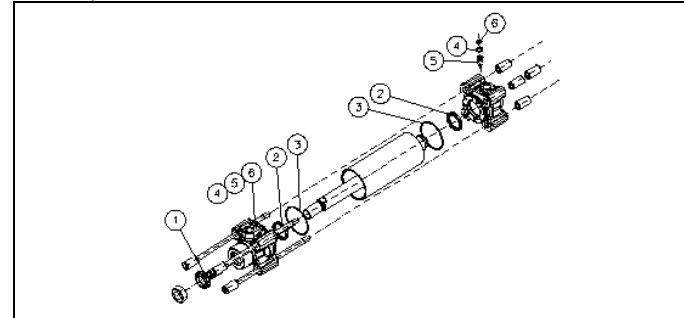

1	Rod Seal
2	Cushion Seal
3	Cylinder Tube Gasket
4	Cushion Valve Seal
5	Cushion Valve

6	Snap Ring
7	Piston Seal
8	Wear Ring
9	Magnet

7.3 Seal Replacement Part Numbers

Warning

Only use SMC seal kits as listed in the table below;

Description	Applicable Bore [mm]	Part Number
-------------	----------------------	-------------

Standard Single Rod	Ø 32 ~ Ø 80	CS95*-
	Ø 100 ~ Ø 125	CS96*-
Standard Double Rod	Ø 32 ~ Ø 80	CS95W*-
	Ø 100 ~ Ø 125	CS96W*-
Single Non-Rotating Rod	Ø 32 ~ Ø 80	CK95*-
	Ø 100 ~ Ø 125	CK96*-
Double Non-Rotating Rod	Ø 32 ~ Ø 80	CK95W*-
	Ø 100 ~ Ø 125	CK96W*-
Single Rod XC22 Option	Ø 32 ~ Ø 80	CS95*-XC22
	Ø 100 ~ Ø 125	CS96*-XC22
Double Rod XC22 Option	Ø 32 ~ Ø 80	CS95W*-XC22
	Ø 100 ~ Ø 125	CS96W*-XC22
Single Rod XC4 Option	Ø 32 ~ Ø 80	CS95*-XC4
	Ø 100	CS96-100-XC4
Double Rod XC4 Option	Ø 32 ~ Ø 80	CS95W*-XC4
	Ø 100	CS96W-100-XC4
Smooth Option	Ø32 ~ Ø 100	C96Y*-PS

Note 4: The * represents the Bore Size (e.g. Ø50 is 50, Ø100 is 100).

Caution

- A wear ring is not fitted to double rod cylinders.

7.4 Lubrication Procedure

- Apply lubricant to:
 - The rod seal and the rod bush.
 - The piston outer surface and piston seal groove.
 - The piston seal, tube gaskets and cushion seals.
 - The piston rod surface and cylinder tube internal surface.

- Lubricate the parts with the grease packs provided with the seal kit. For additional grease use the grease pack listed below.

Product	Grease Pack Number	Weight [g]
Standard	GR-S-010	10
	GR-S-020	20
Smooth (Y type)	GR-L-010	10

The amount of lubricant to be applied is listed in the following table.

Bore [mm]	Stroke up to 100mm [g]	For each additional 50mm Stroke [g]
Ø 32	3	0.5
Ø 40	3 ~ 4	1.0
Ø 50	3 ~ 5	1.0
Ø 63	4 ~ 5	1.5
Ø 80	6 ~ 8	1.5
Ø 100	8 ~ 10	2.0
Ø 125	15 ~ 17	3.0

7.5 Reassembly Procedure

- Insert the new seals into the appropriate seal groove.
- Insert the piston rod assembly into the cylinder tube. Be careful not to damage the piston seal.
- Attach the covers to the cylinder tube. Be careful not to damage the tube gaskets and rod seal.
- Screw the tie rod nuts onto the tie rod on the end with the short thread.
- Insert the tie rod assemblies into appropriate holes in the head cover.
- Screw the tie rods into the rod cover. Tighten the diagonally opposite tie rod nuts according to the values listed in the table below.

Bore [mm]	Torque ± 10% [N.m]
Ø 32 & Ø 40	4.8
Ø 50 & Ø 63	10.4
Ø 80 & Ø 100	18.2
Ø 125	28.5

Warning

- Mounting precision is required for the trunnion type cylinder. It is difficult to align the axial centre of the trunnion with the axial centre of the cylinder. When reassembling the cylinder, take care with the trunnion location accuracy.

Caution

- Ø80 and Ø100 use flat washers on the tie rod nuts.

8 Limitations of Use

8.1 Limited warranty and Disclaimer/Compliance Requirements

Refer to Handling Precautions for SMC Products located on www.smcworld.com.

8.2 Obligations of the end-user

- Ensure the product is used within the specification outlined.
- Ensure that the maintenance periods are suitable for the application.
- Ensure any cleaning processes to remove dust layers are made with the atmosphere in mind (e.g. using a damp cloth to avoid static build up).
- Ensure that the application does not introduce additional hazards by mounting, loading, impacts or other methods.
- Ensure that there is sufficient ventilation and air circulation around the product.
- If the product is subject to direct heat sources in the application, they should be shielded so that the actuator temperature stays within the stated operating range.

Caution

- SMC products are not intended for use as instruments for legal metrology.

Measurement instruments that SMC manufactures or sells have not been qualified by type approval tests relevant to the metrology (measurement) laws of each country.

Danger

- Do not exceed any of the specifications listed in Section 2 of this document as this will be deemed improper use.
- Air equipment has an air leakage during operation within certain limits. Do not use this equipment when the air itself introduces additional hazards and could lead to an explosion.
- Use only ATEX certified auto switches. These should be ordered separately.
- Do not use this product in the presence of strong magnetic fields that could generate a surface temperature higher than the product

specification.

- Avoid applications where the piston rod end and the adjoining part in the application can create a possible ignition source.
- Do not install or use these actuators where there is the possibility for the piston rod to impact foreign objects.
- In the event of damage or failure of any parts located in the vicinity where this product has been installed, it is the responsibility of the user to determine whether or not this has compromised the safety and condition of this product and/or the application.
- External impact on the cylinder body could result in a spark and/or cylinder damage. Avoid any application where foreign objects can hit or impact the cylinder. In such situations the application should install a suitable guard to prevent this occurrence.
- Do not use this equipment where vibration could lead to failure.

9 Contacts

Refer to Declaration of Conformity and www.smcworld.com for contacts.

SMC Corporation

URL : <http://www.smcworld.com> (Global) <http://www.smceu.com> (Europe)
 SMC Corporation, Akihabara UDX15F, 4-14-1, Sotokanda, Chiyoda-ku, Tokyo 101 0021
 Specifications are subject to change without prior notice from the manufacturer.
 © 2018 SMC Corporation All Rights Reserved.
 Template DKP50047-F-085H